

50V P-CHANNEL Enhancement Mode MOSFET

MTP3J15Y3

BV_{DSS}	-50V
I_D	-130mA
$R_{DS(on)}@-10V$	8Ω (MAX)
$R_{DS(on)}@-5V$	10Ω (MAX)
$R_{DS(on)}@-4V$	12Ω (MAX)
$R_{DS(on)}@-2.5V$	32Ω (MAX)

Features

- Low gate charge
- Excellent thermal and electrical capabilities
- ESD protected gate
- Pb-free lead plating and halogen-free package

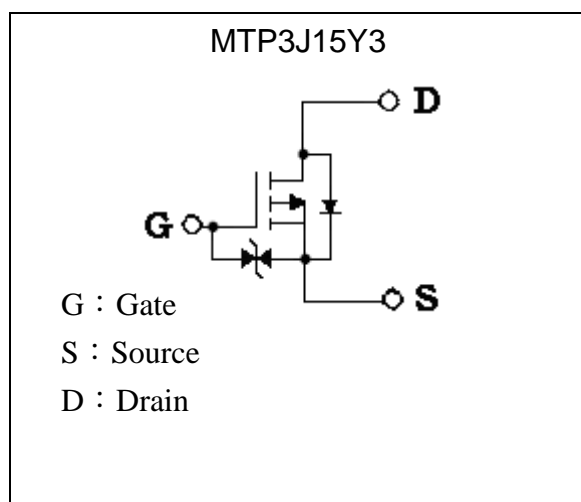
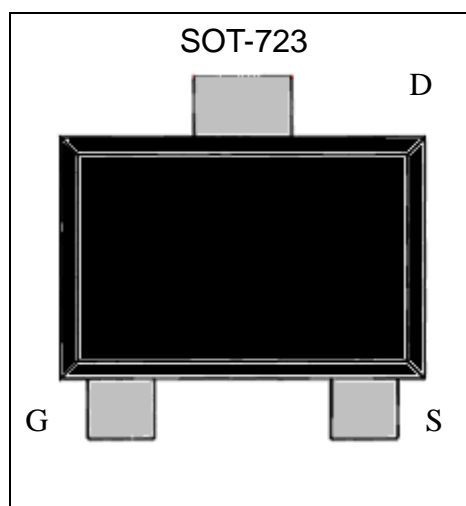
Equivalent Circuit

Outline

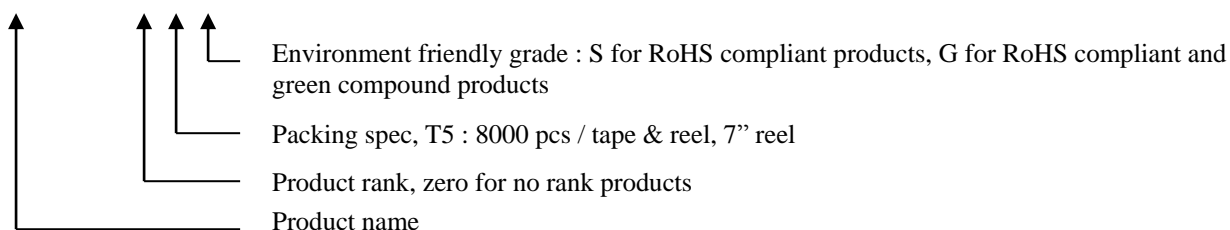
Ordering Information

Device	Package	Shipping
MTP3J15Y3-0-T5-G	SOT-723 (Pb-free lead plating and halogen-free package)	8000 pcs / tape & reel





Absolute Maximum Ratings (Tj=25°C, unless otherwise noted)

Parameter	Symbol	Limits	Unit
Drain-Source Voltage	V _{DS}	-50	V
Gate-Source Voltage	V _{GS}	±20	
Continuous Drain Current @ T _A =25°C, V _{GS} =-10V	I _D	-130	mA
Pulsed Drain Current (Note 1)	I _{DM}	-520	
Maximum Power Dissipation @ T _A =25°C (Note 2)	P _D	150	mW
Thermal Resistance, Junction-to-Ambient (Note 2)	R _{th,ja}	833	°C/W
Operating Junction and Storage Temperature Range	T _j , T _{stg}	-55~+150	°C

Note : 1. Pulse width ≤ 10μs, duty cycle ≤ 2%.
 2. Surface mounted on 1 in² copper pad of FR-4 board, t ≤ 5s.

Electrical Characteristics (Tj=25°C, unless otherwise specified)

Symbol	Min.	Typ.	Max.	Unit	Test Conditions
Static					
BV _{DSS}	-50	-	-	V	V _{GS} =0V, I _D =-250μA
V _{GS(th)}	-1	-1.4	-2		V _{DS} =V _{GS} , I _D =-1mA
G _{FS}	20	-	-	mS	V _{DS} =-3V, I _D =-10mA
I _{GSS}	-	-	±10	μA	V _{GS} =±20V, V _{DS} =0V
I _{DSS}	-	-	-1		V _{DS} =-50V, V _{GS} =0V
	-	-	-25	V _{DS} =-50V, V _{GS} =0V, T _j =125°C	
*R _{DS(ON)}	-	5	8	Ω	V _{GS} =-10V, I _D =-100mA
	-	6	10		V _{GS} =-5V, I _D =-100mA
	-	-	12		V _{GS} =-4V, I _D =-10mA
	-	-	32		V _{GS} =-2.5V, I _D =-1mA
Dynamic					
C _{iss}	-	25	-	pF	V _{DS} =-5V, V _{GS} =0V, f=1MHz
C _{oss}	-	7	-		
C _{rss}	-	2	-		
*t _{d(ON)}	-	2.5	-	ns	V _{DS} =-15V, I _D =-100mA, V _{GS} =-5V, R _G =3.3Ω
*t _r	-	2	-		
*t _{d(OFF)}	-	7.3	-		
*t _f	-	3	-		
*Q _g	-	1.2	-	nC	V _{DS} =-40V, I _D =-500mA, V _{GS} =-5V
Source-Drain Diode					
*I _S	-	-	-130	mA	
*I _{SM}	-	-	-520		
*V _{SD}	-	-0.85	-1.2	V	V _{GS} =0V, I _S =-130mA

*Pulse Test : Pulse Width ≤ 300μs, Duty Cycle ≤ 2%

Typical Characteristics

Typical Output Characteristics

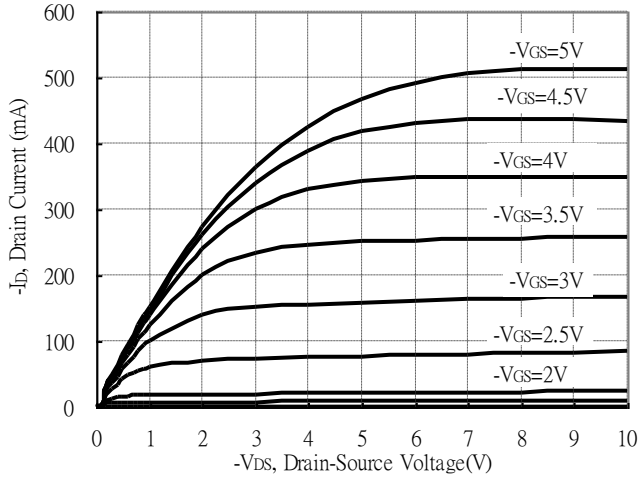

Breakdown Voltage vs Ambient Temperature

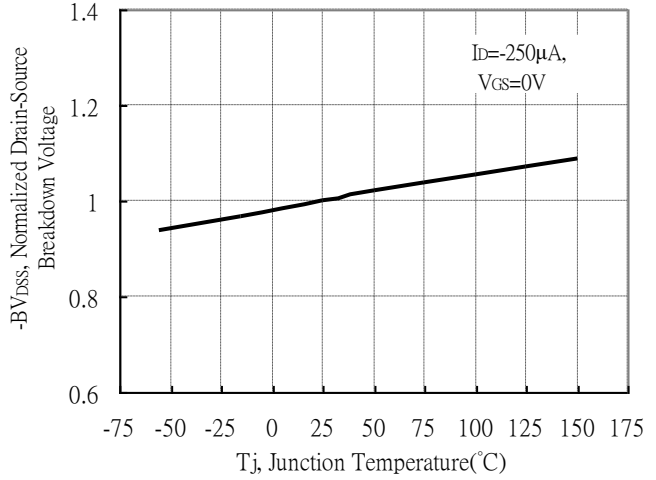

Static Drain-Source On-State resistance vs Drain Current

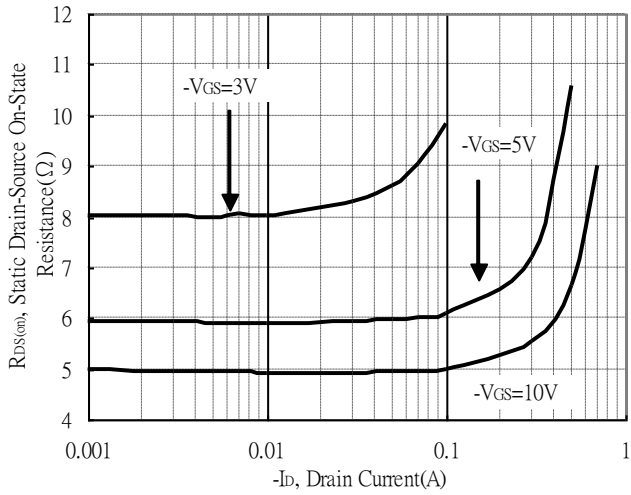

Reverse Drain Current vs Source-Drain Voltage

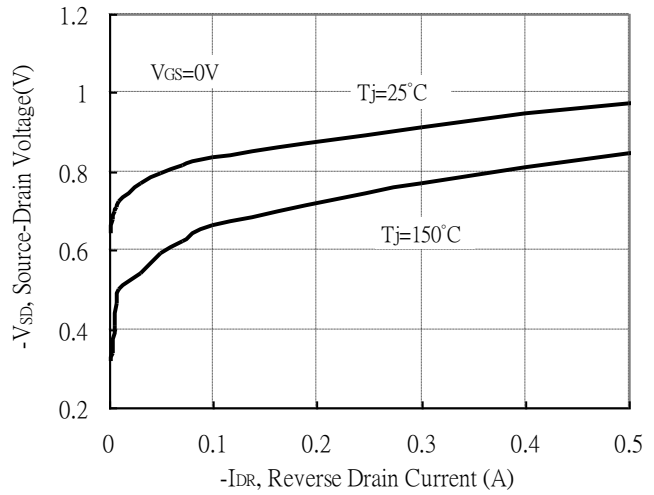

Static Drain-Source On-State Resistance vs Gate-Source Voltage

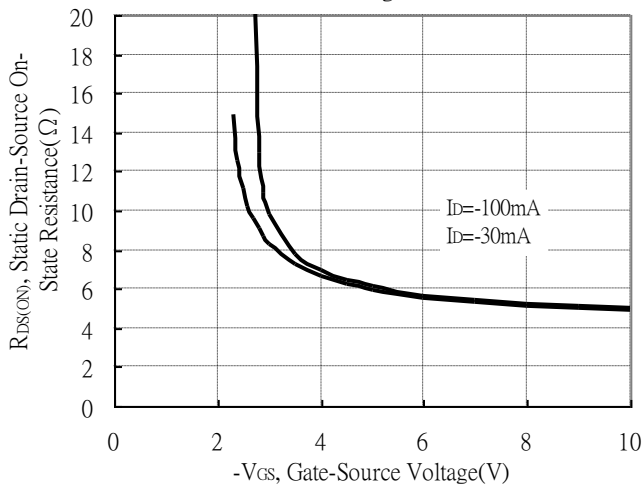

Drain-Source On-State Resistance vs Junction Temperature

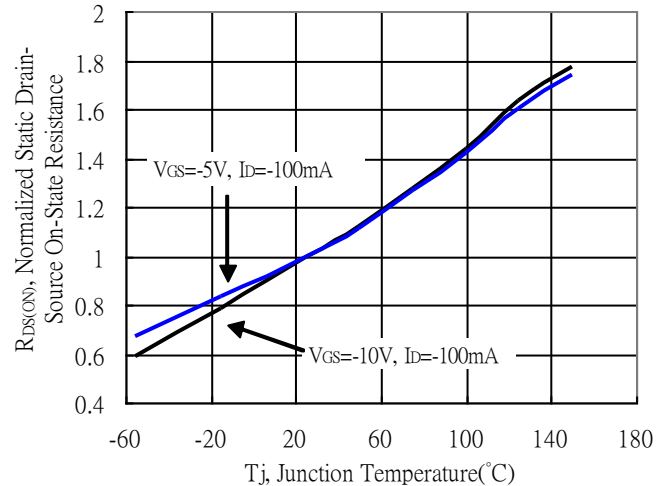

Typical Characteristics(Cont.)

Capacitance vs Drain-to-Source Voltage

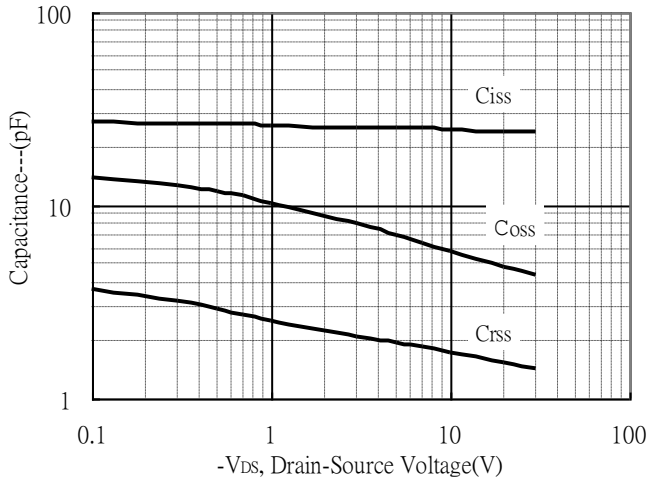

Threshold Voltage vs Junction Temperature

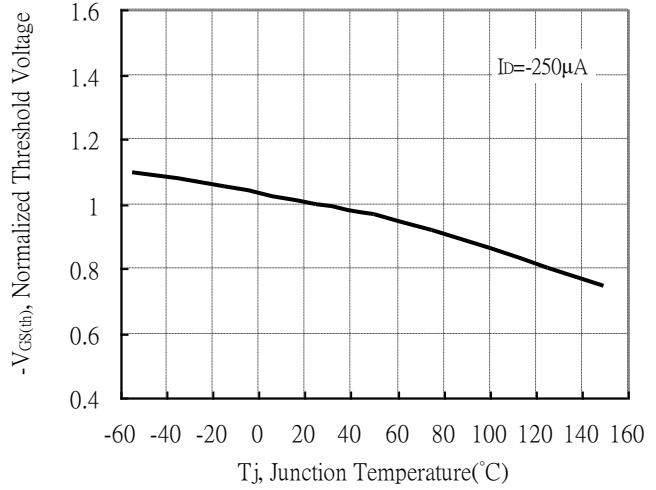

Single Pulse Power Rating, Junction to Ambient
 (Note on page 1)

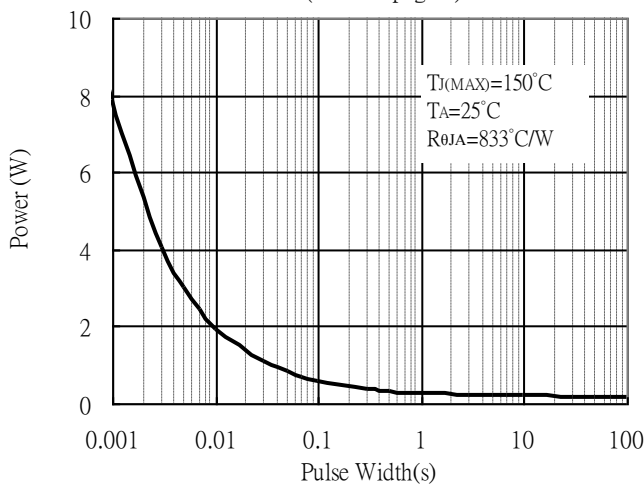

Gate Charge Characteristics

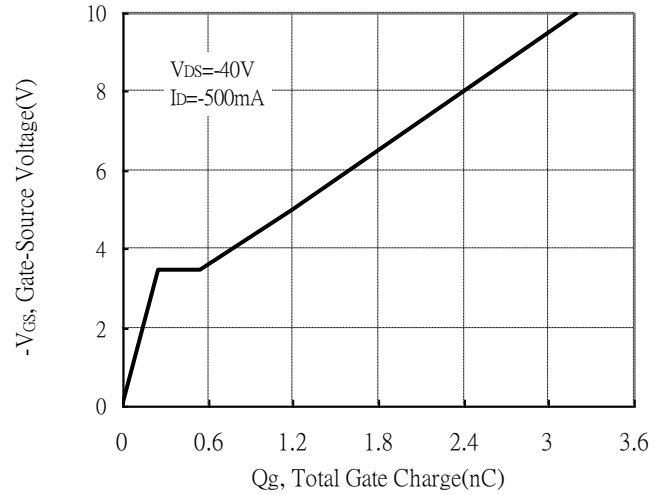

Maximum Safe Operating Area

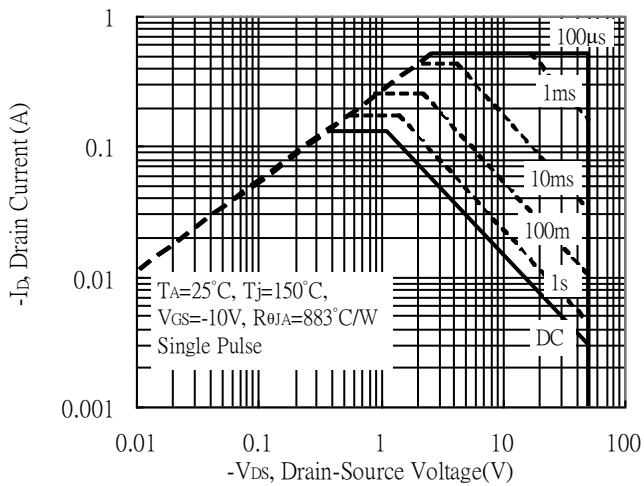

Maximum Drain Current vs Junction Temperature

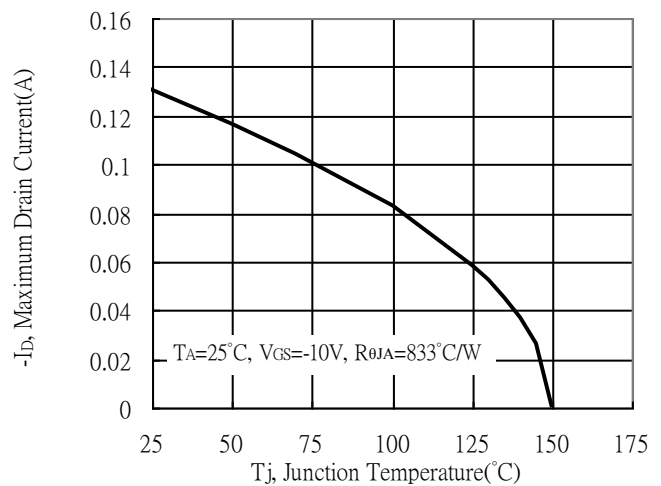

Typical Characteristics(Cont.)

Typical Transfer Characteristics

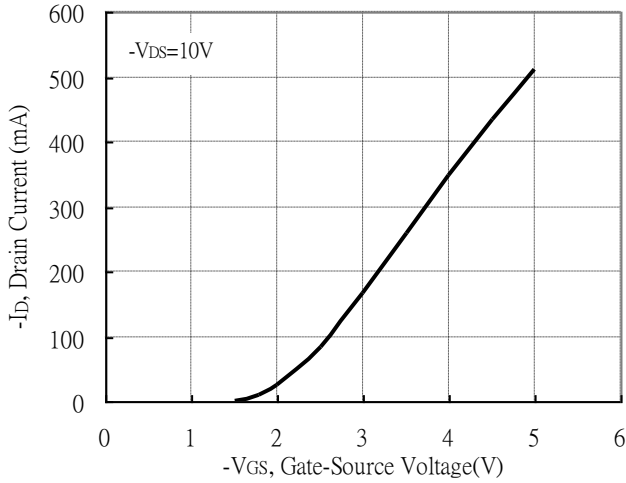

Power Derating Curve

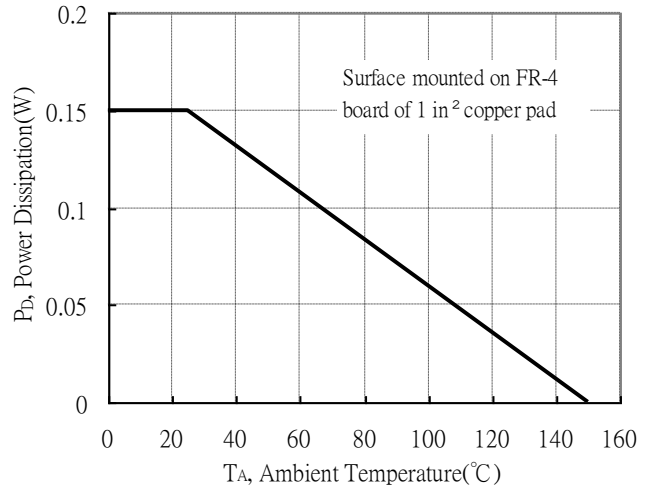

Transient Thermal Response Curves

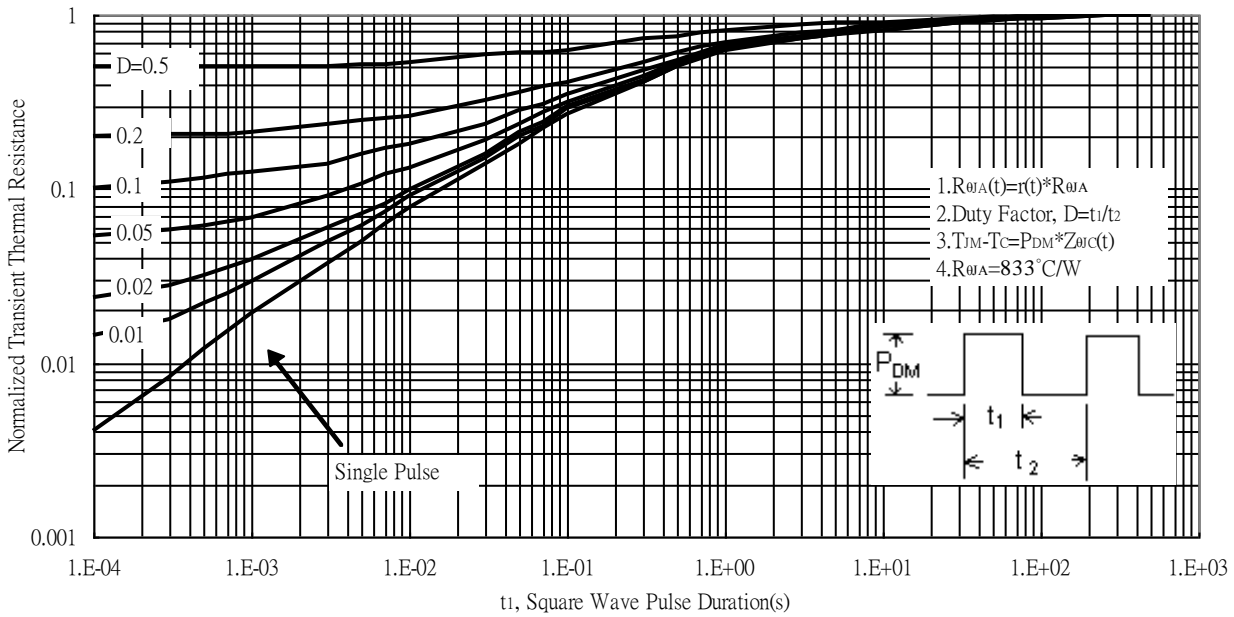

Reel Dimension

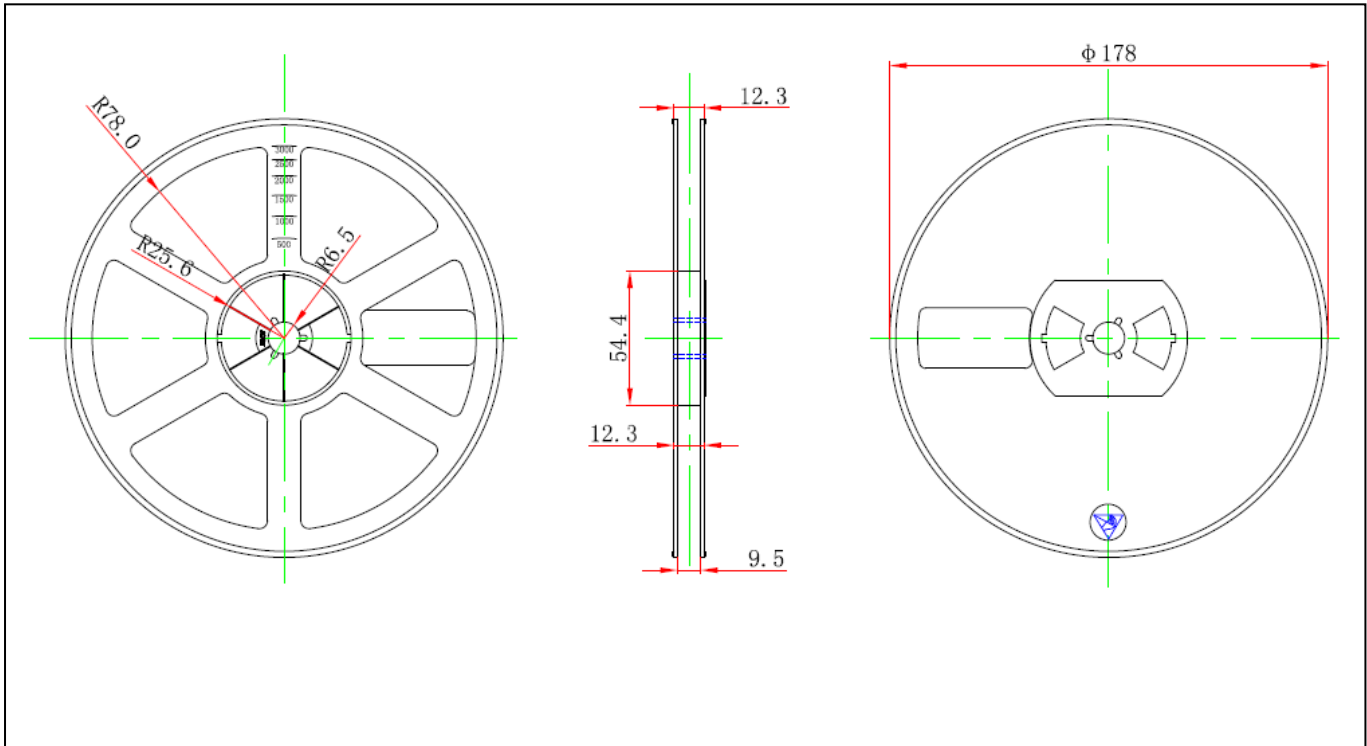

Carrier Tape Dimension

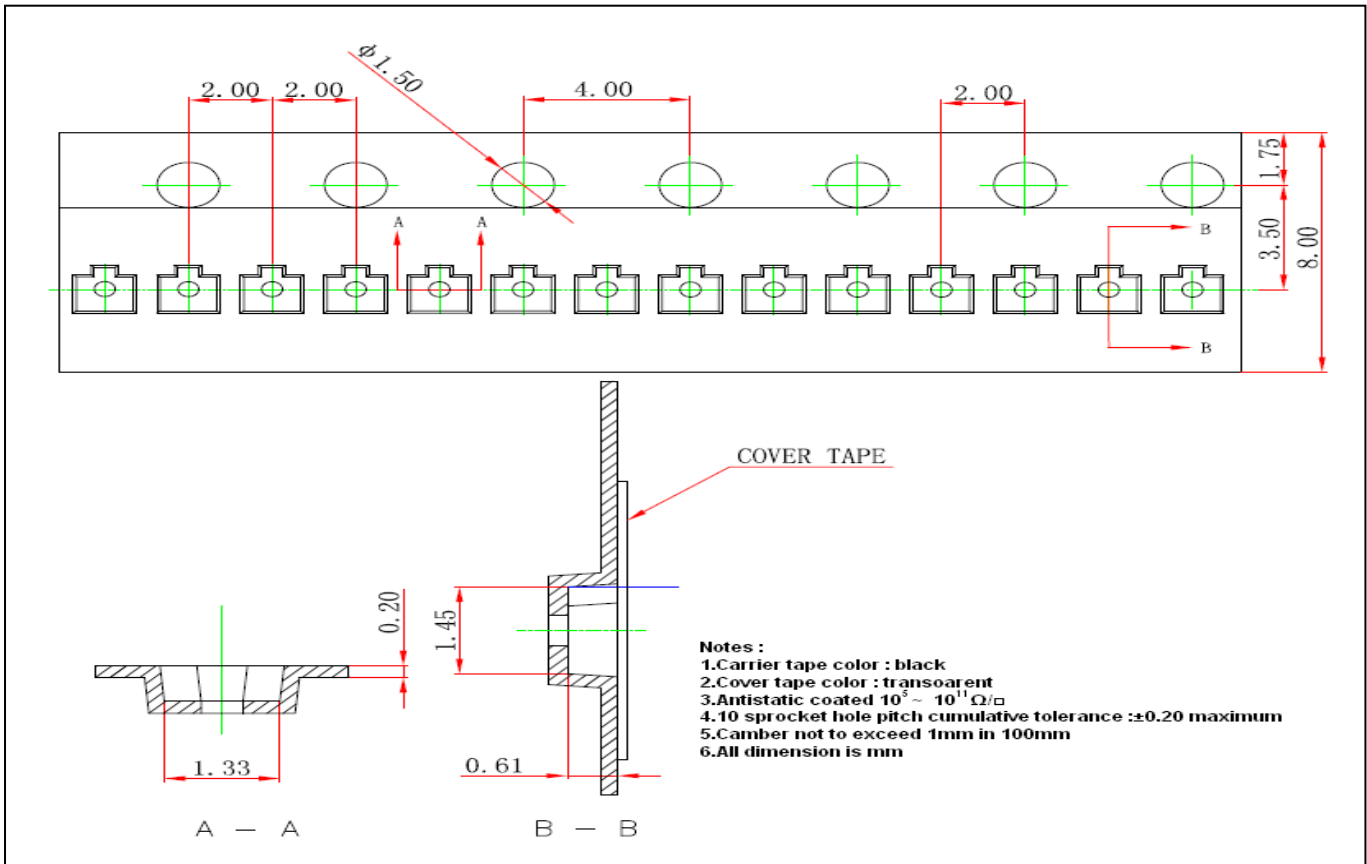

Recommended wave soldering condition

Product	Peak Temperature	Soldering Time
Pb-free devices	260 +0/-5 °C	5 +1/-1 seconds

Recommended temperature profile for IR reflow

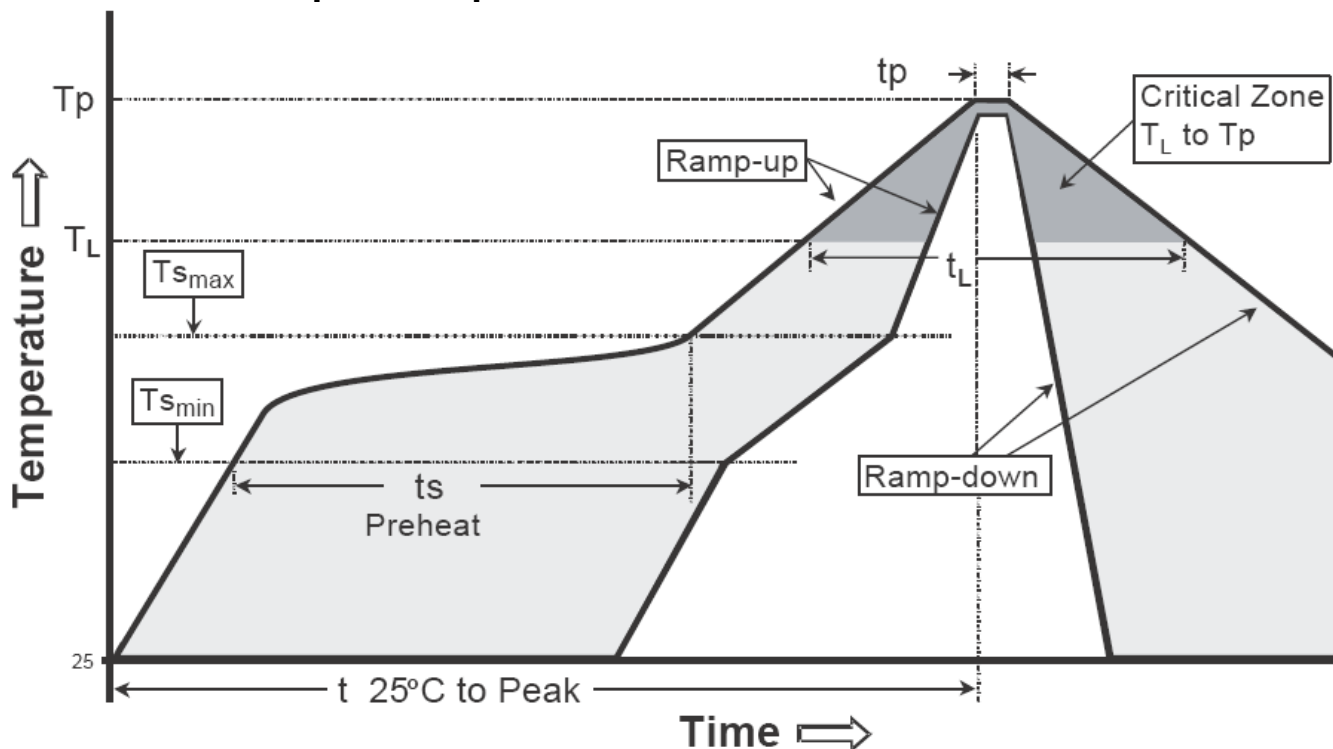

Profile feature	Sn-Pb eutectic Assembly	Pb-free Assembly
Average ramp-up rate (Tsmmax to Tp)	3°C/second max.	3°C/second max.
Preheat		
-Temperature Min(Ts min)	100°C	150°C
-Temperature Max(Ts max)	150°C	200°C
-Time(ts min to ts max)	60-120 seconds	60-180 seconds
Time maintained above:		
-Temperature (Tl)	183°C	217°C
- Time (tl)	60-150 seconds	60-150 seconds
Peak Temperature(Tp)	240 +0/-5 °C	260 +0/-5 °C
Time within 5°C of actual peak temperature(tp)	10-30 seconds	20-40 seconds
Ramp down rate	6°C/second max.	6°C/second max.
Time 25 °C to peak temperature	6 minutes max.	8 minutes max.

Note : All temperatures refer to topside of the package, measured on the package body surface.

SOT-723 Dimension

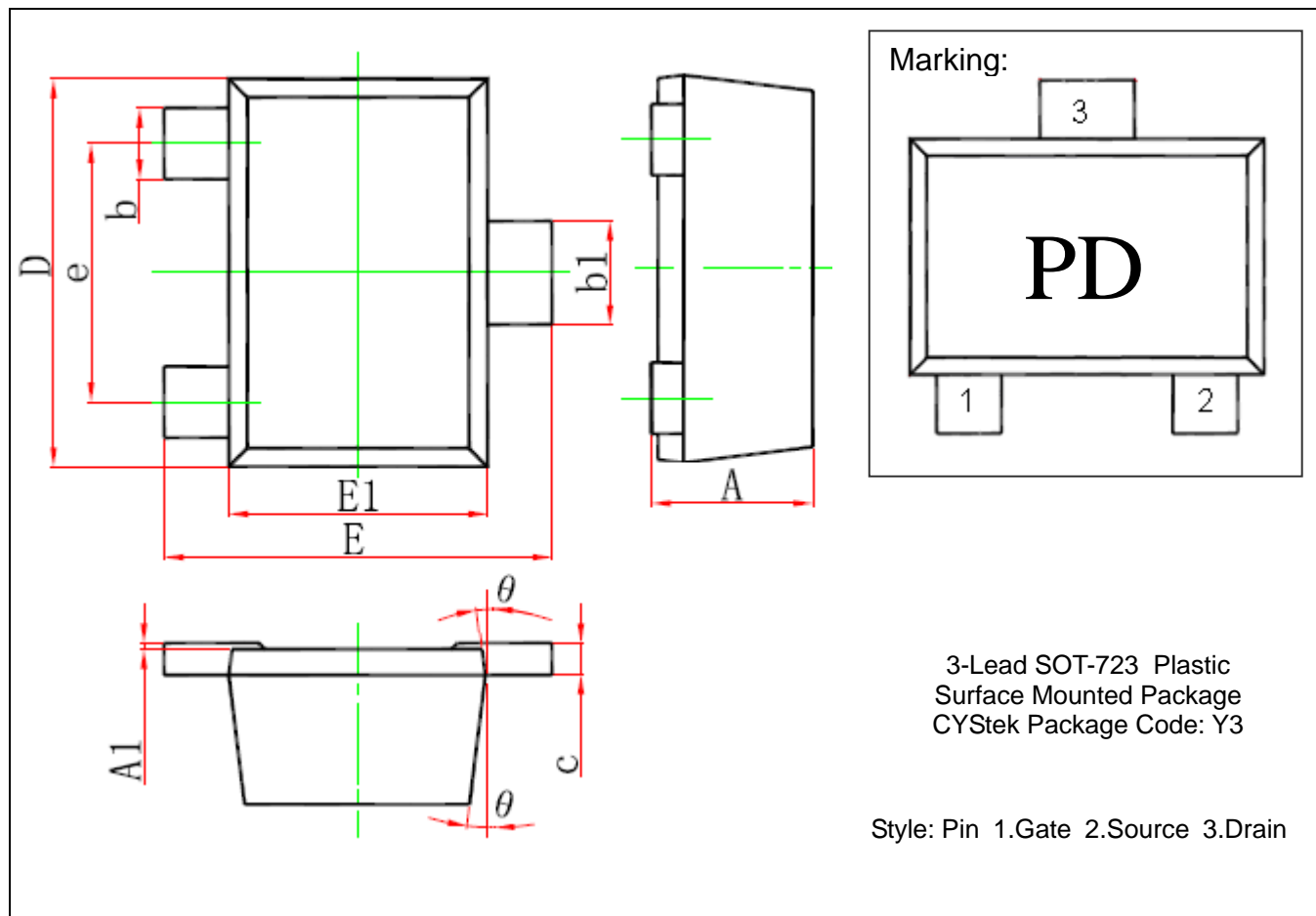

*Typical

DIM	Millimeters		Inches		DIM	Millimeters		Inches	
	Min.	Max.	Min.	Max.		Min.	Max.	Min.	Max.
A	0.000	0.500	0.000	0.020	D	1.150	1.250	0.045	0.049
A1	0.000	0.050	0.000	0.002	E	1.150	1.250	0.045	0.049
b	0.170	0.270	0.007	0.011	E1	0.750	0.850	0.030	0.033
b1	0.270	0.370	0.011	0.015	e	0.800*		0.031*	
c	0.000	0.150	0.000	0.006	θ	7° REF		7° REF	

Notes: 1.Controlling dimension: millimeters.
 2.Maximum lead thickness includes lead finish thickness, and minimum lead thickness is the minimum thickness of base material.
 3.If there is any question with packing specification or packing method, please contact your local CYStek sales office.

Material:

- Lead: Pure tin plated.
- Mold Compound: Epoxy resin family, flammability solid burning class: UL94V-0.

Important Notice:

- All rights are reserved. Reproduction in whole or in part is prohibited without the prior written approval of CYStek.
- CYStek reserves the right to make changes to its products without notice.
- CYStek **semiconductor products are not warranted to be suitable for use in Life-Support Applications, or systems.**
- CYStek assumes no liability for any consequence of customer product design, infringement of patents, or application assistance.