

20V P-Channel Enhancement Mode MOSFET

MTP2305AN3

BV_{DSS}	-20V
$I_D@V_{GS}=-4.5V, T_A=25^{\circ}C$	-3.4A
$R_{DS(on)(TYP)}@V_{GS}=-4.5V, I_D=-2.8A$	79mΩ
$R_{DS(on)(TYP)}@V_{GS}=-2.5V, I_D=-2A$	116mΩ

Features

- Advanced trench process technology
- High density cell design for ultra low on resistance
- Excellent thermal and electrical capabilities
- Compact and low profile SOT-23 package
- Pb-free lead plating and halogen-free package

Equivalent Circuit

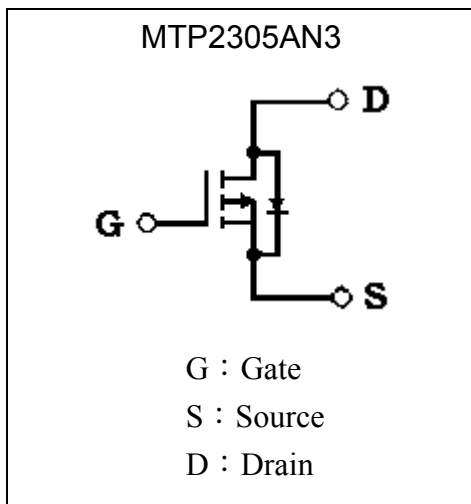

Outline

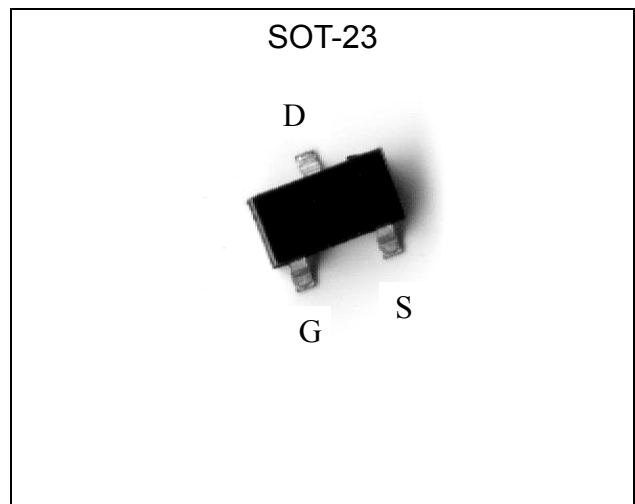

Ordering Information

Device	Package	Shipping
MTP2305AN3-0-T1-G	SOT-23 (Pb-free lead plating and halogen-free package)	3000 pcs / Tape & Reel

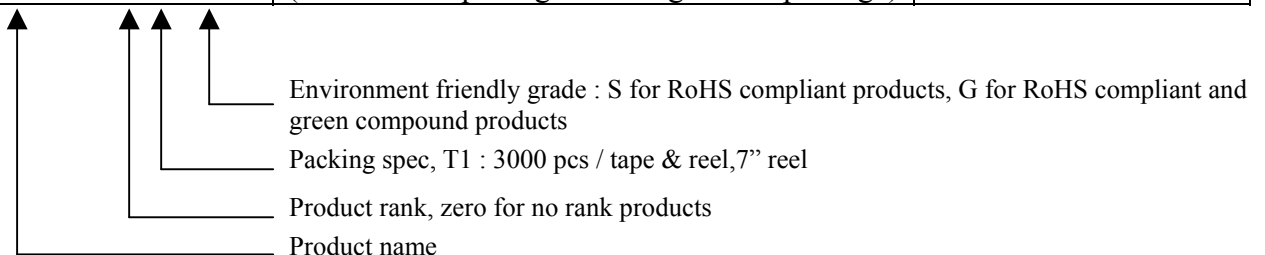



Absolute Maximum Ratings (Ta=25°C)

Parameter	Symbol	Limits	Unit
Drain-Source Voltage	VDS	-20	V
Gate-Source Voltage	VGS	±8	V
Continuous Drain Current @TA=25°C, VGS=-4.5V	ID	-3.4	A
Continuous Drain Current @TA=70°C, VGS=-4.5V		-2.7	
Pulsed Drain Current	IDM	-10	
Maximum Power Dissipation	PD	Ta=25°C	1.38 (Note)
		Ta=70°C	0.88 (Note)
Operating Junction and Storage Temperature Range	Tj ; Tstg	-55~+150	°C

Thermal Performance

Parameter	Symbol	Limit	Unit
Thermal Resistance, Junction-to-Ambient(PCB mounted)	Rth,ja	90 (Note)	°C/W
Lead Temperature, for 5 second soldering(1/8" from case)	TL	260	°C

Note : Surface mounted on 1 in ²FR-4 board with 2 oz. copper, t ≤ 5sec; 270 °C/W when mounted on minimum copper pad.

Electrical Characteristics (Ta=25°C)

Symbol	Min.	Typ.	Max.	Unit	Test Conditions
Static					
BVDSS	-20	-	-	V	VGS=0, ID=-250μA
VGS(th)	-0.45	-	-	V	VDS=VGS, ID=-250μA
IGSS	-	-	±100	nA	VGS=±8V, VDS=0
IDSS	-	-	-1	μA	VDS=-16V, VGS=0
*RDS(ON)	-	79	108	mΩ	ID=-2.8A, VGS=-4.5V
	-	116	150		ID=-2A, VGS=-2.5V
*GFS	-	6.3	-	S	VDS=-5V, ID=-2.8A
Dynamic					
Ciss	-	446	-	pF	VDS=-10V, VGS=0, f=1MHz
Coss	-	57	-		
Crss	-	52	-		
td(ON)	-	9.2	20	ns	VDD=-10V, ID=-1A, RL=6Ω, VGEN=-4.5V, RG=6Ω
tr	-	7.3	60		
td(OFF)	-	38	50		
tf	-	12	20		
Qg	-	3	10	nC	VDS=-10V, ID=-3A, VGS=-2.5V,
Qgs	-	0.8	-		
Qgd	-	1.1	-		

Source-Drain Diode					
I_S	-	-	-1.6	A	-
V_{SD}	-	-0.86	-1.2	V	$V_{GS}=0V, I_S=-1.6A$
t_{rr}^*	-	30	-	ns	$I_F=-3A, dI_F/dt=100A/\mu s$
Q_{rr}^*	-	25	-	nC	

*Pulse Test : Pulse Width $\leq 300\mu s$, Duty Cycle $\leq 2\%$

Recommended Soldering Footprint

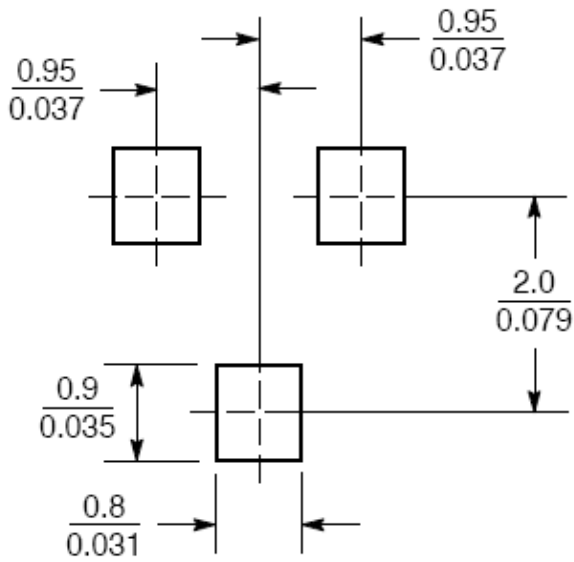

Unit : $\frac{mm}{inches}$



Typical Characteristics

Typical Output Characteristics

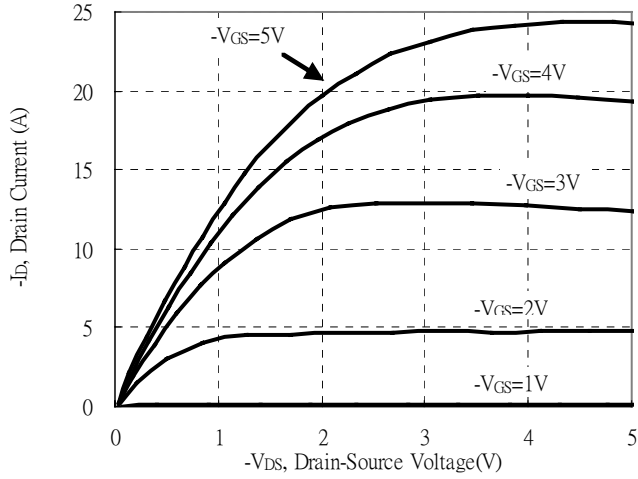

Brekdown Voltage vs Ambient Temperature

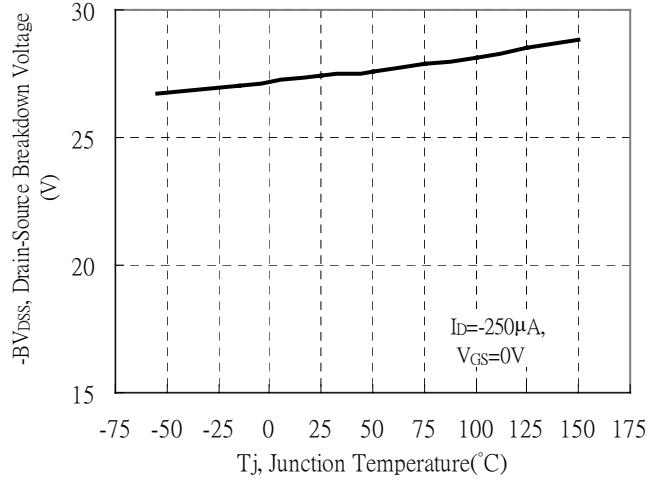

Static Drain-Source On-State resistance vs Drain Current

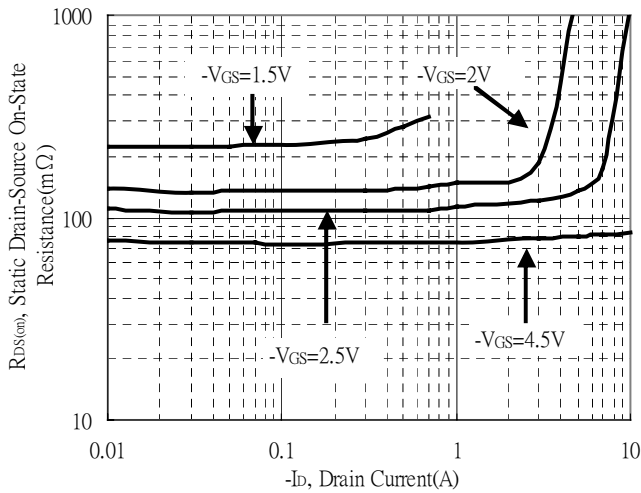

Reverse Drain Current vs Source-Drain Voltage

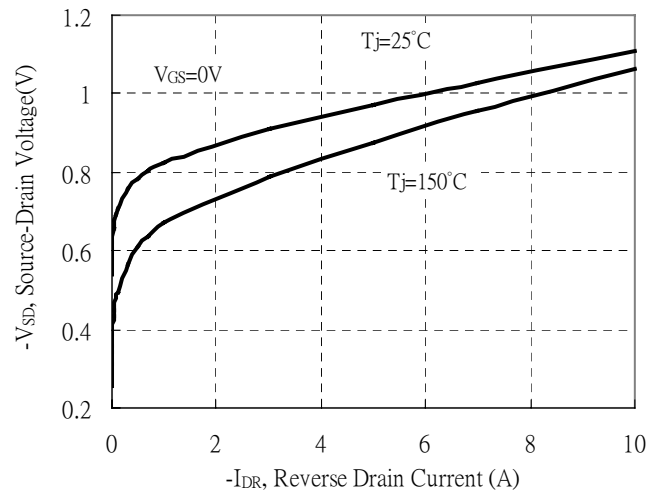

Static Drain-Source On-State Resistance vs Gate-Source Voltage

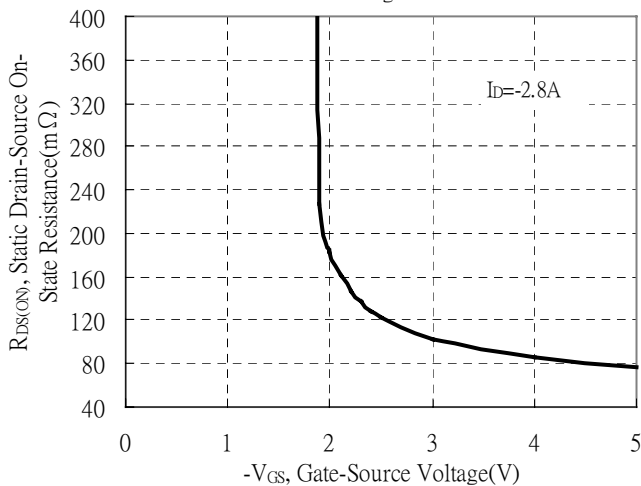

Drain-Source On-State Resistance vs Junction Temperature

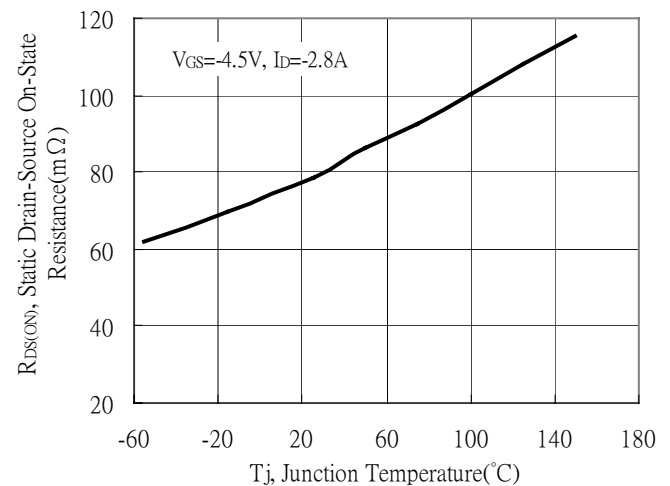

Typical Characteristics(Cont.)

Capacitance vs Drain-to-Source Voltage

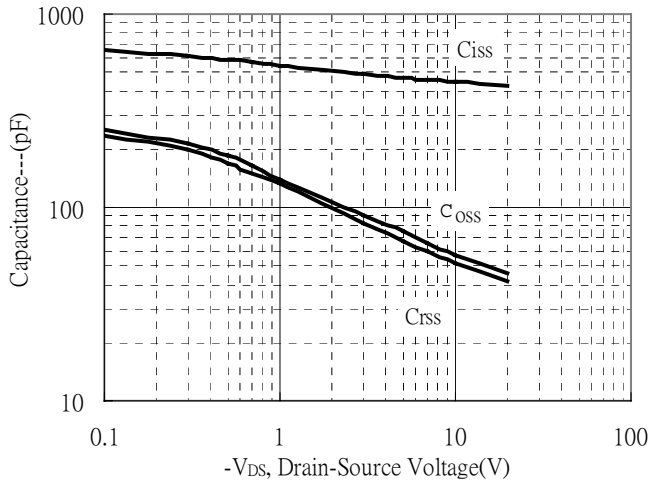

Threshold Voltage vs Junction Temperature

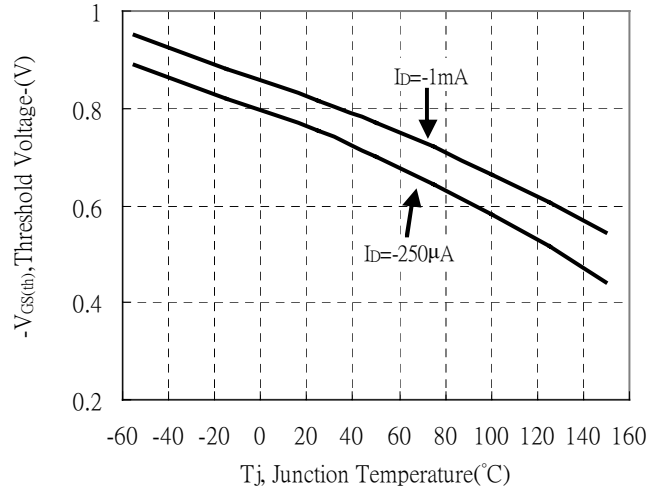

Single Pulse Power Rating, Junction to Ambient
 (Note 1 on page 2)

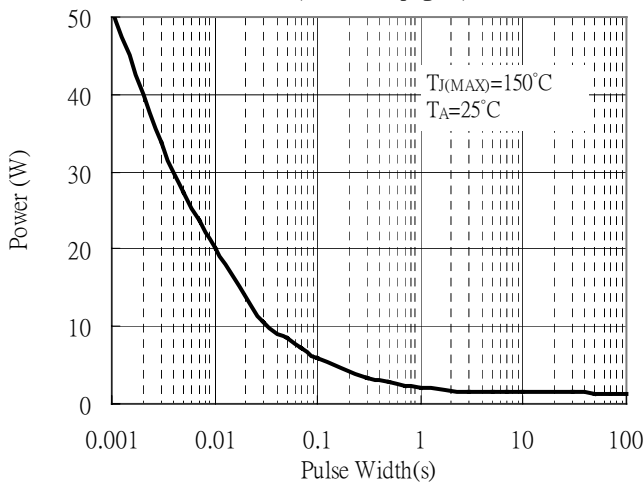

Gate Charge Characteristics

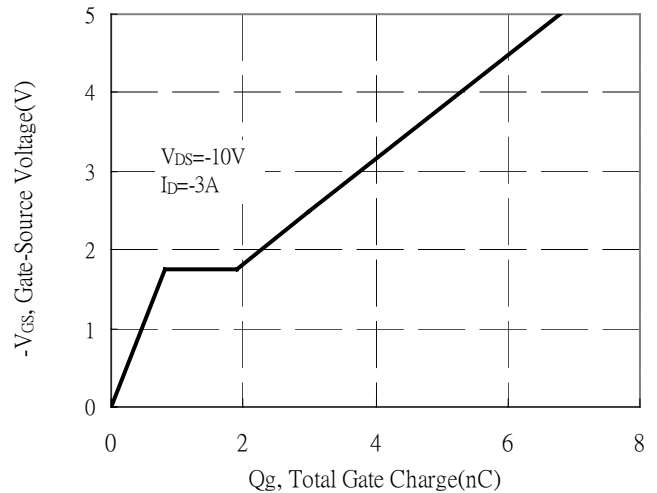

Maximum Safe Operating Area

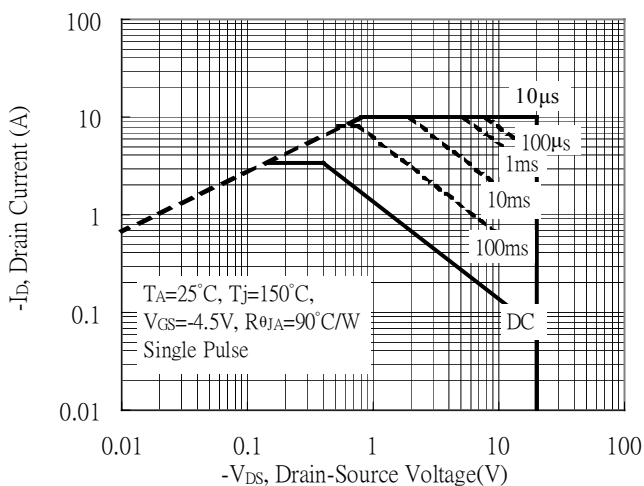

Maximum Drain Current vs Junction Temperature

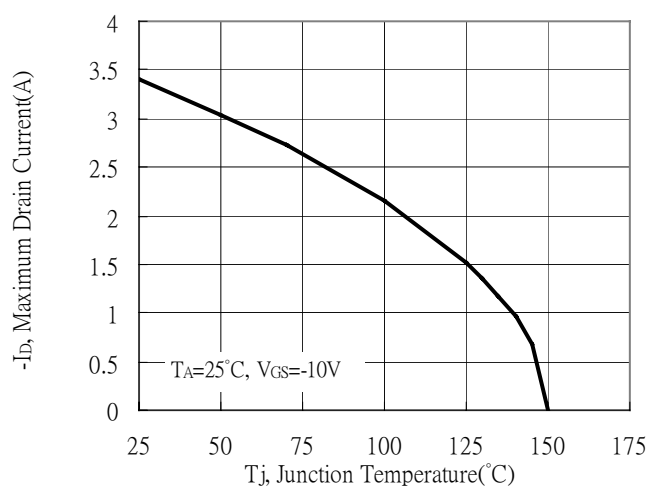



Typical Characteristics(Cont.)

Typical Transfer Characteristics

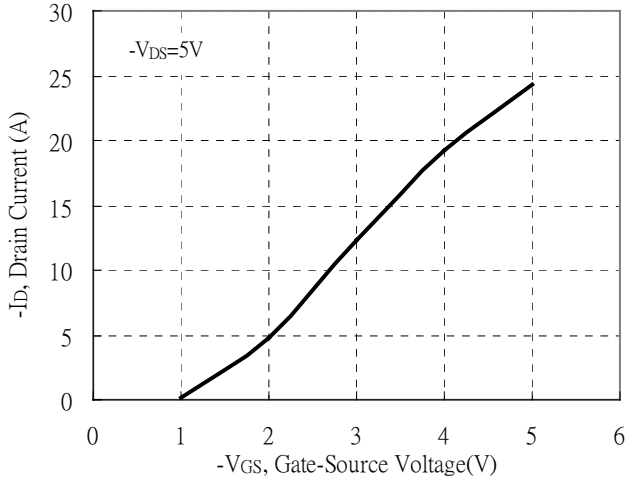

Power Derating Curve

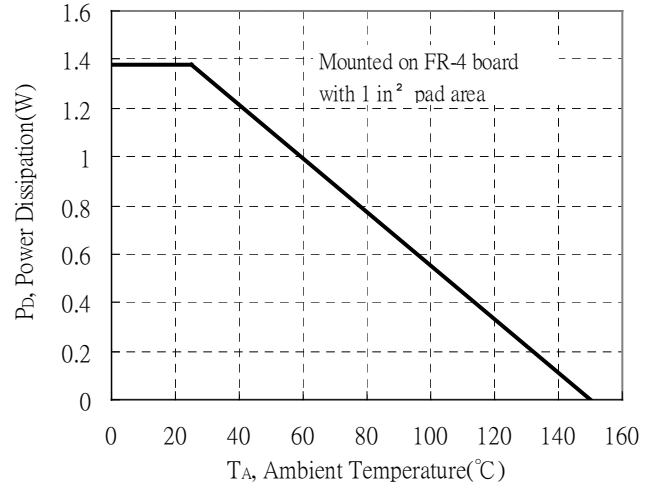

Transient Thermal Response Curves

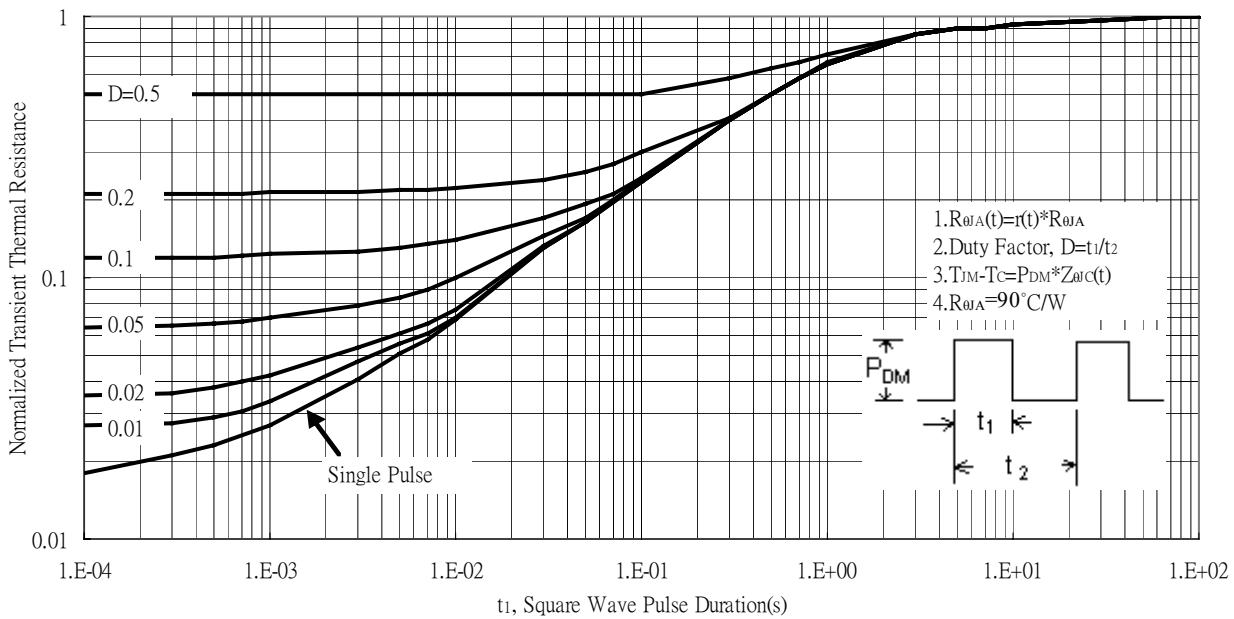

Reel Dimension

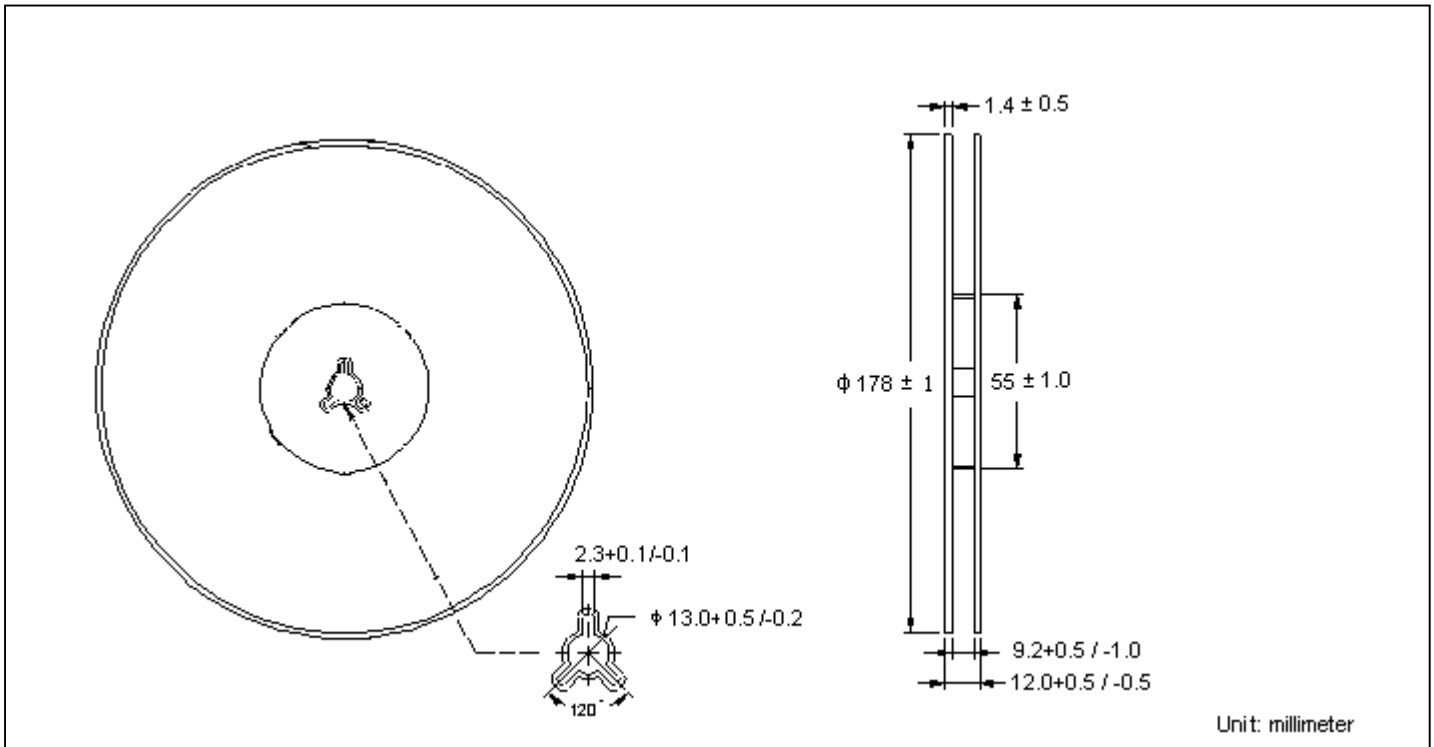

Carrier Tape Dimension

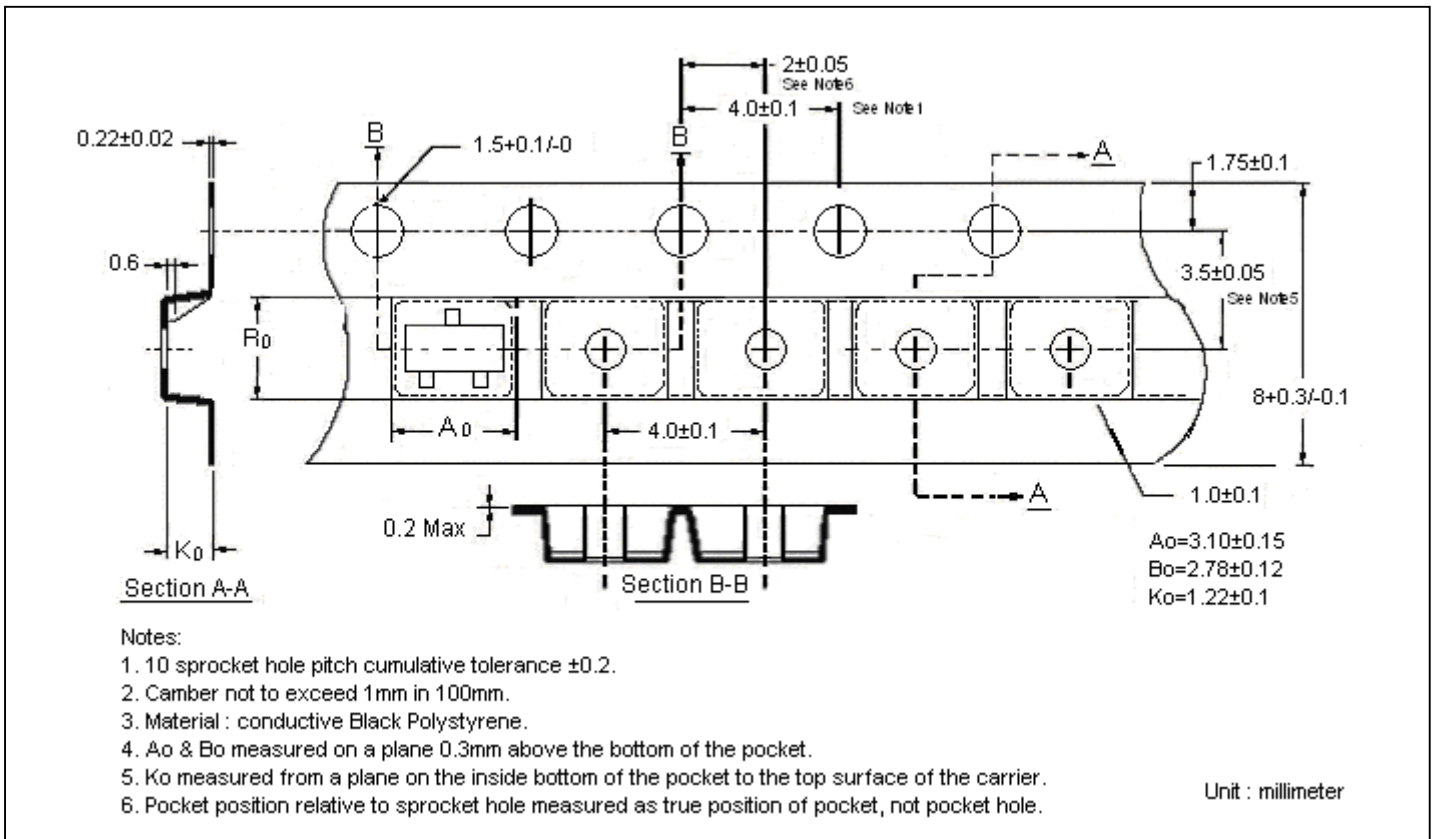

Recommended wave soldering condition

Product	Peak Temperature	Soldering Time
Pb-free devices	260 +0/-5 °C	5 +1/-1 seconds

Recommended temperature profile for IR reflow

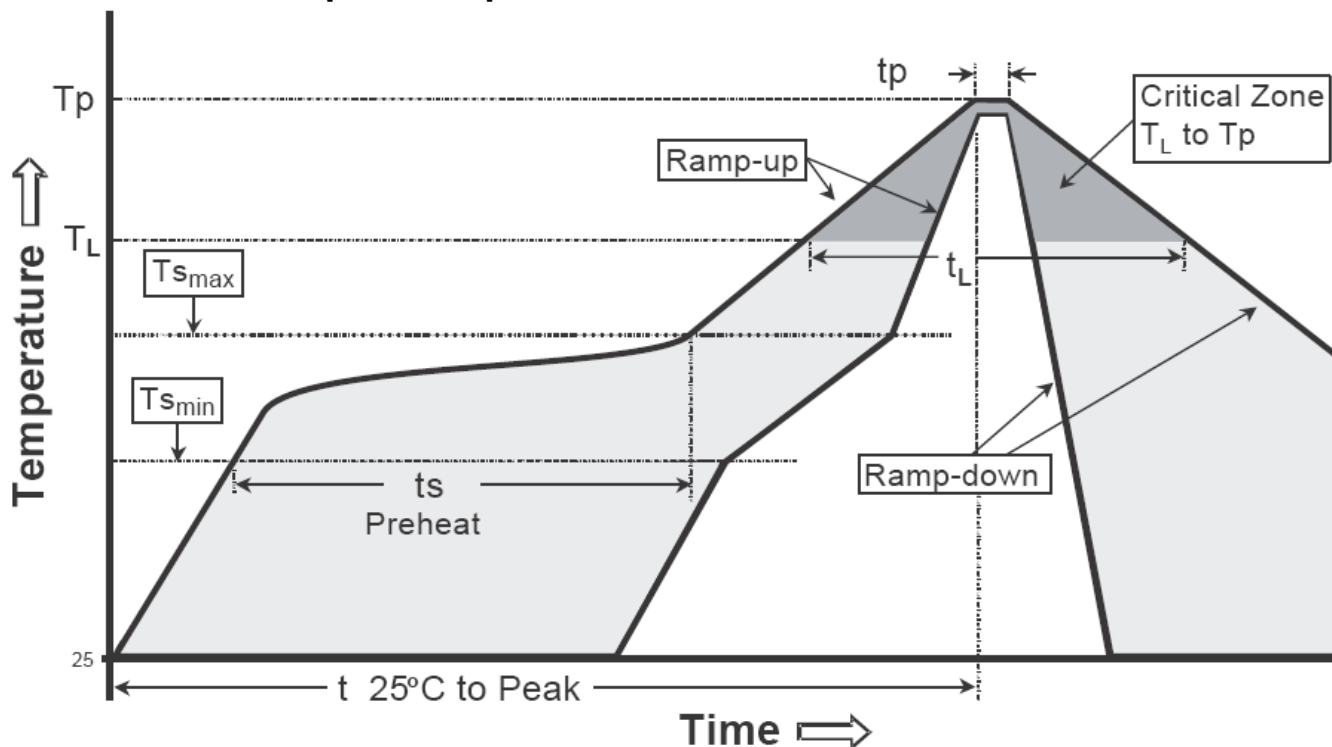

Profile feature	Sn-Pb eutectic Assembly	Pb-free Assembly
Average ramp-up rate (Tsmax to Tp)	3°C/second max.	3°C/second max.
Preheat		
-Temperature Min(Ts min)	100°C	150°C
-Temperature Max(Ts max)	150°C	200°C
-Time(ts min to ts max)	60-120 seconds	60-180 seconds
Time maintained above:		
-Temperature (TL)	183°C	217°C
- Time (tL)	60-150 seconds	60-150 seconds
Peak Temperature(TP)	240 +0/-5 °C	260 +0/-5 °C
Time within 5°C of actual peak temperature(tp)	10-30 seconds	20-40 seconds
Ramp down rate	6°C/second max.	6°C/second max.
Time 25 °C to peak temperature	6 minutes max.	8 minutes max.

Note : All temperatures refer to topside of the package, measured on the package body surface.

SOT-23 Dimension

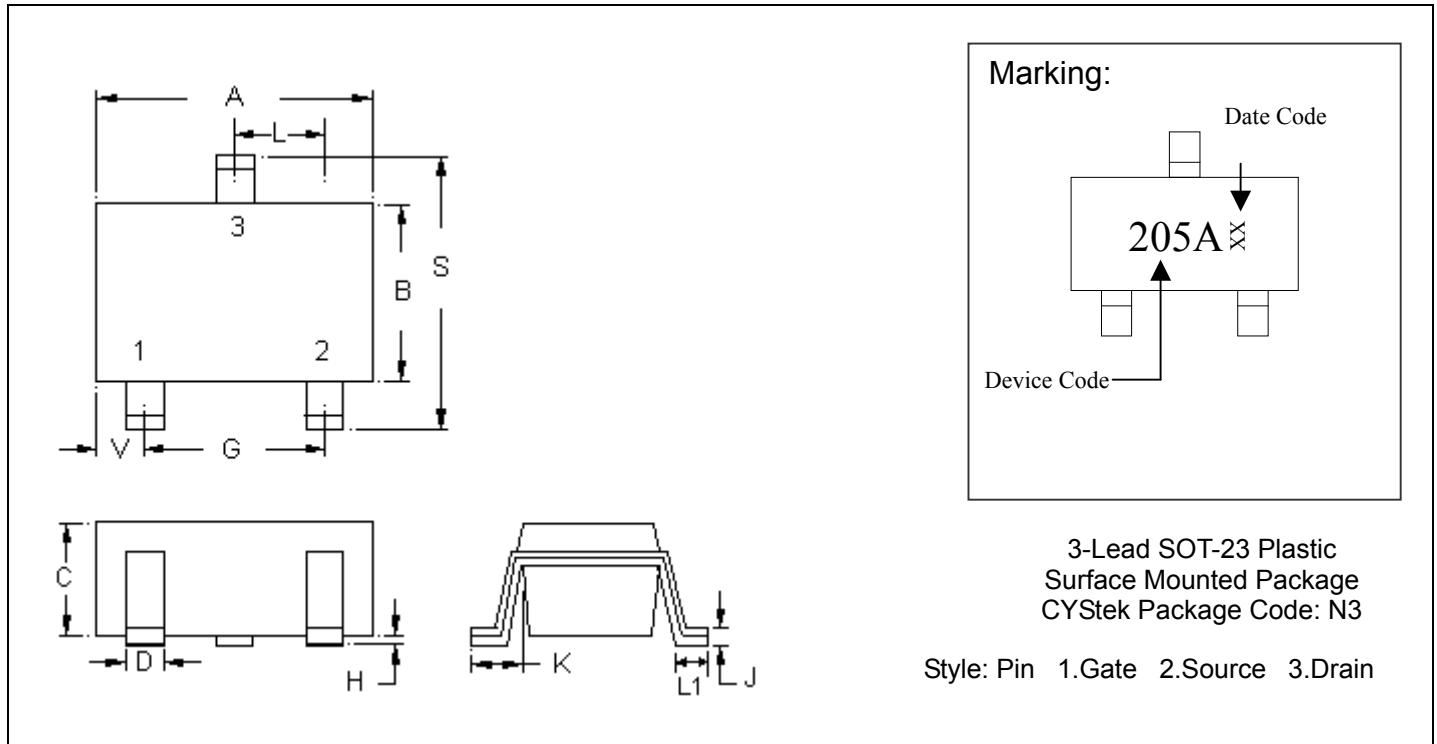

*: Typical

DIM	Inches		Millimeters		DIM	Inches		Millimeters	
	Min.	Max.	Min.	Max.		Min.	Max.	Min.	Max.
A	0.1102	0.1204	2.80	3.04	J	0.0032	0.0079	0.08	0.20
B	0.0472	0.0669	1.20	1.70	K	0.0118	0.0266	0.30	0.67
C	0.0335	0.0512	0.89	1.30	L	0.0335	0.0453	0.85	1.15
D	0.0118	0.0197	0.30	0.50	S	0.0830	0.1161	2.10	2.95
G	0.0669	0.0910	1.70	2.30	V	0.0098	0.0256	0.25	0.65
H	0.0000	0.0040	0.00	0.10	L1	0.0118	0.0197	0.30	0.50

- Notes: 1.Controlling dimension: millimeters.
 2.Maximum lead thickness includes lead finish thickness, and minimum lead thickness is the minimum thickness of base material.
 3.If there is any question with packing specification or packing method, please contact your local CYStek sales office.

Material:

- Lead: Pure tin plated.
- Mold Compound: Epoxy resin family, flammability solid burning class: UL94V-0.

Important Notice:

- All rights are reserved. Reproduction in whole or in part is prohibited without the prior written approval of CYStek.
- CYStek reserves the right to make changes to its products without notice.
- CYStek **semiconductor products are not warranted to be suitable for use in Life-Support Applications, or systems.**
- CYStek assumes no liability for any consequence of customer product design, infringement of patents, or application assistance.