

**-20V P-CHANNEL Enhancement Mode MOSFET**

# MTP1013C3

BV <sub>DSS</sub>	-20V
I <sub>D</sub> @ T <sub>A</sub> =25°C, V <sub>GS</sub> =-4.5V	-500mA
R <sub>DS(on)</sub> @ V <sub>GS</sub> =-4.5V, I <sub>D</sub> =-500mA	0.63 Ω (typ)
R <sub>DS(on)</sub> @ V <sub>GS</sub> =-2.5V, I <sub>D</sub> =-300mA	1.1 Ω (typ)
R <sub>DS(on)</sub> @ V <sub>GS</sub> =-1.8V, I <sub>D</sub> =-10mA	1.7 Ω (typ)

**Features**

- Very low level gate drive requirements allowing direct operation in 3V circuits. V<sub>GS(th)</sub><1.2V.
- Compact industrial standard SOT-523 surface mount package.
- ESD protected gate
- Pb-free lead plating and halogen-free package.

**Equivalent Circuit**

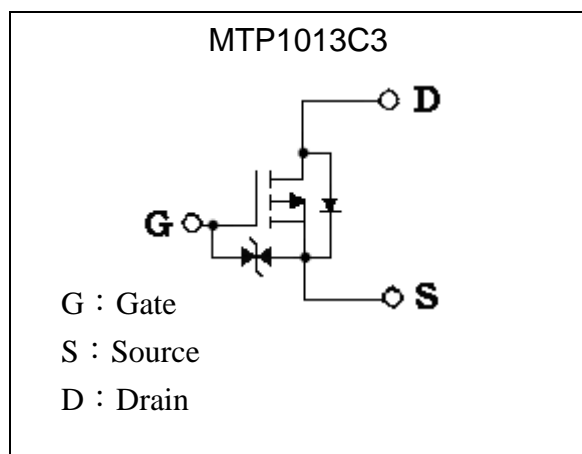

**Outline**

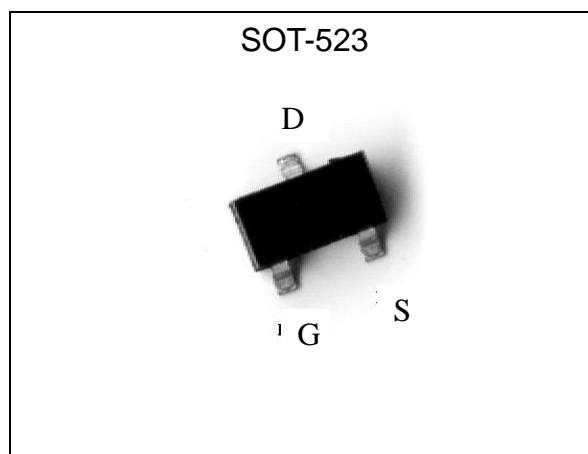

**Ordering Information**

Device	Package	Shipping
MTP1013C3-0-T1-G	SOT-523 (Pb-free lead plating package)	3000 pcs / tape & reel

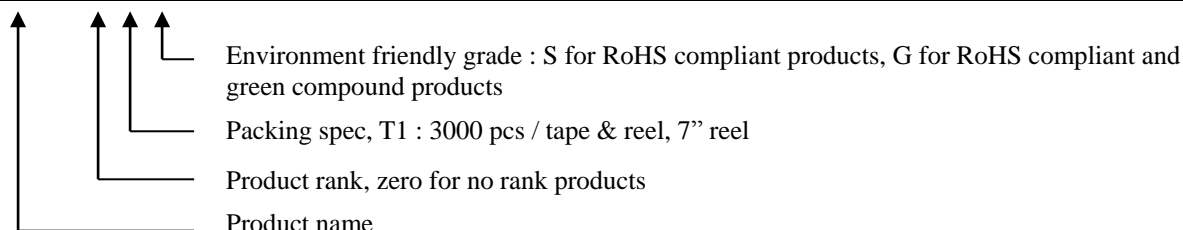



**Absolute Maximum Ratings** (Tj=25°C, unless otherwise noted)

Parameter	Symbol	Limits	Unit
Drain-Source Voltage	V <sub>DS</sub>	-20	V
Gate-Source Voltage	V <sub>GS</sub>	±8	
Continuous Drain Current @ T <sub>A</sub> =25°C, V <sub>GS</sub> =-4.5V	I <sub>D</sub>	-0.5	A
Continuous Drain Current @ T <sub>A</sub> =70°C, V <sub>GS</sub> =-4.5V		-0.4	
Pulsed Drain Current *1	I <sub>DM</sub>	-2	
Maximum Power Dissipation @ T <sub>A</sub> =25°C	P <sub>D</sub>	280 *2	mW
Thermal Resistance, Junction-to-Ambient	R <sub>th,ja</sub>	450 *2	°C/W
Operating Junction and Storage Temperature	T <sub>j</sub> , T <sub>stg</sub>	-55~+150	°C

Note : 1. Pulse width ≤ 10μs, duty cycle ≤ 2%.  
 2. When mounted on FR-4 board with 1 sq inch pad size.

**Electrical Characteristics** (Tj=25°C, unless otherwise specified)

Symbol	Min.	Typ.	Max.	Unit	Test Conditions
<b>Static</b>					
BV <sub>DSS</sub>	-20	-	-	V	V <sub>GS</sub> =0V, I <sub>D</sub> =-250μA
V <sub>GS(th)</sub>	-0.5	-	-1.2		V <sub>DS</sub> =V <sub>GS</sub> , I <sub>D</sub> =-250μA
G <sub>FS</sub>	-	0.7	-	S	V <sub>DS</sub> =-10V, I <sub>D</sub> =-250mA
I <sub>GSS</sub>	-	-	±2	μA	V <sub>GS</sub> =±8V, V <sub>DS</sub> =0V
I <sub>DSS</sub>	-	-	-1		V <sub>DS</sub> =-20V, V <sub>GS</sub> =0V
	-	-	-10		V <sub>DS</sub> =-20V, V <sub>GS</sub> =0V, T <sub>j</sub> =55°C
*R <sub>DS(ON)</sub>	-	0.63	0.9	Ω	V <sub>GS</sub> =-4.5V, I <sub>D</sub> =-500mA
	-	1.1	1.4		V <sub>GS</sub> =-2.5V, I <sub>D</sub> =-300mA
	-	1.7	2.7		V <sub>GS</sub> =-1.8V, I <sub>D</sub> =-10mA
<b>Dynamic</b>					
C <sub>iss</sub>	-	59	-	pF	V <sub>DS</sub> =-10V, V <sub>GS</sub> =0V, f=1MHz
C <sub>oss</sub>	-	21	-		
C <sub>rss</sub>	-	15	-		
*t <sub>d(ON)</sub>	-	5	-	ns	V <sub>DS</sub> =-10V, I <sub>D</sub> =-200mA, V <sub>GS</sub> =-4.5V, R <sub>G</sub> =10Ω
*t <sub>r</sub>	-	6	-		
*t <sub>d(OFF)</sub>	-	42	-		
*t <sub>f</sub>	-	14	-		
*Q <sub>g</sub>	-	1.5	-	nC	V <sub>DS</sub> =-10V, I <sub>D</sub> =-250mA, V <sub>GS</sub> =-4.5V
*Q <sub>gs</sub>	-	0.28	-		
*Q <sub>gd</sub>	-	0.44	-		
<b>Source-Drain Diode</b>					
*I <sub>S</sub>	-	-	-0.5	A	
*I <sub>SM</sub>	-	-	-2		
*V <sub>SD</sub>	-	-0.88	-1.2	V	V <sub>GS</sub> =0V, I <sub>S</sub> =-150mA

\*Pulse Test : Pulse Width ≤ 300μs, Duty Cycle ≤ 2%

**Typical Characteristics**

Typical Output Characteristics

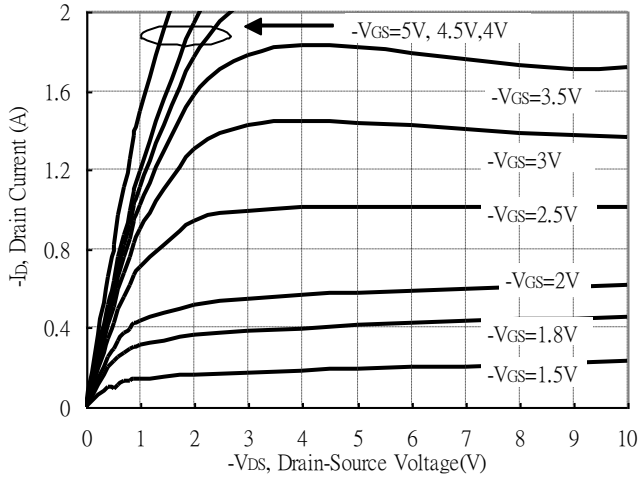

Breakdown Voltage vs Ambient Temperature

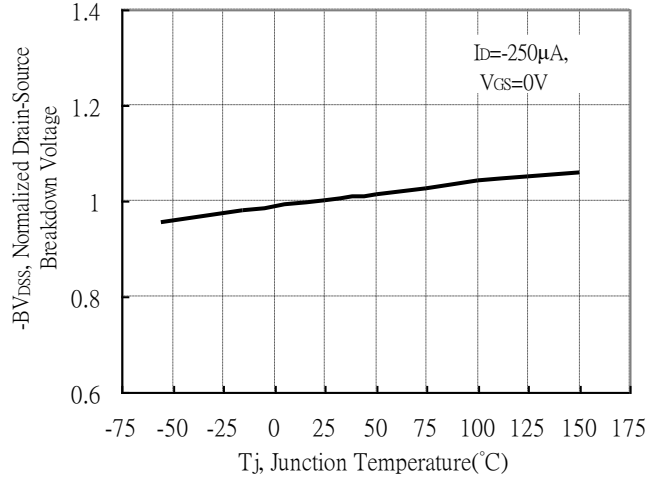

Static Drain-Source On-State resistance vs Drain Current

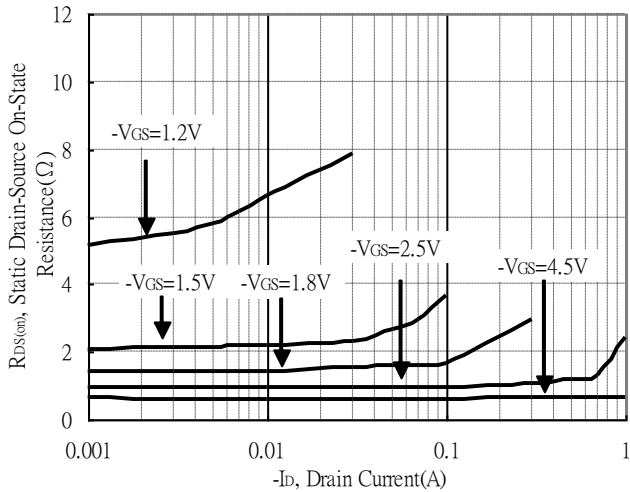

Reverse Drain Current vs Source-Drain Voltage

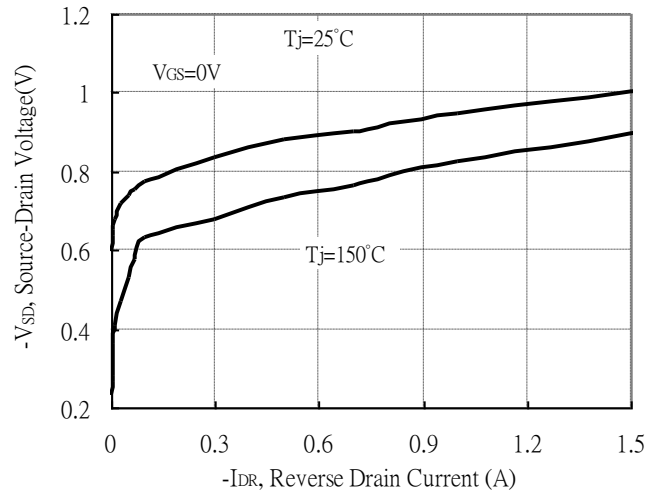

Static Drain-Source On-State Resistance vs Gate-Source Voltage

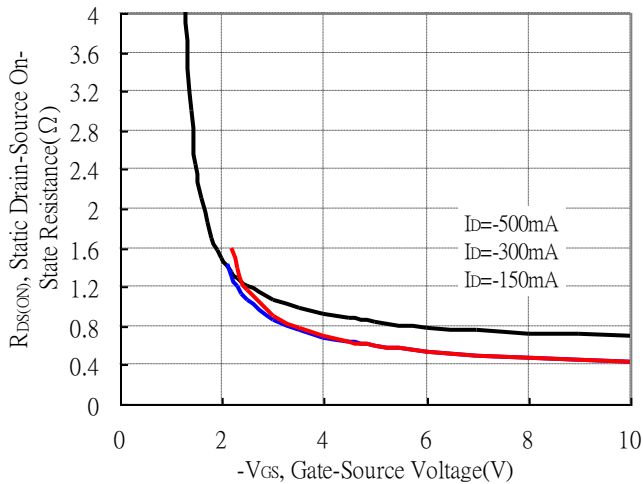

Drain-Source On-State Resistance vs Junction Temperature

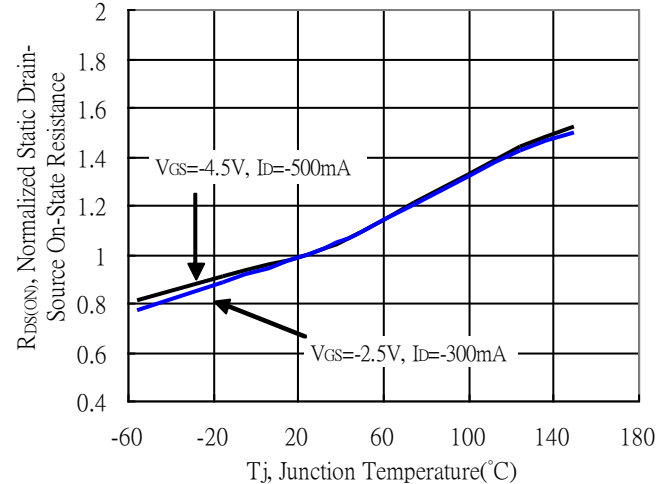

**Typical Characteristics(Cont.)**

Capacitance vs Drain-to-Source Voltage

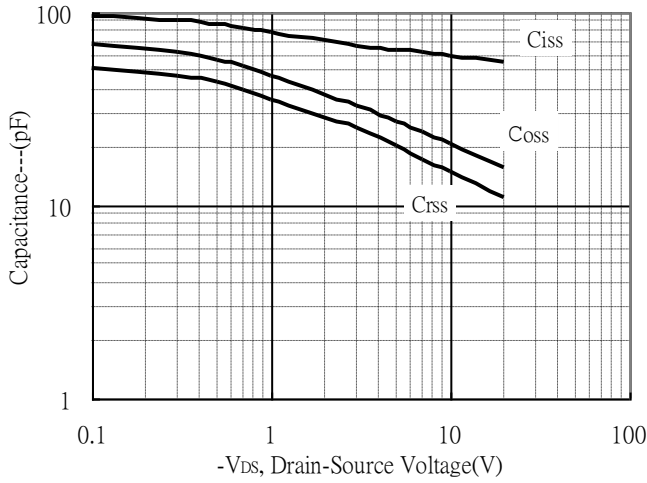

Threshold Voltage vs Junction Temperature

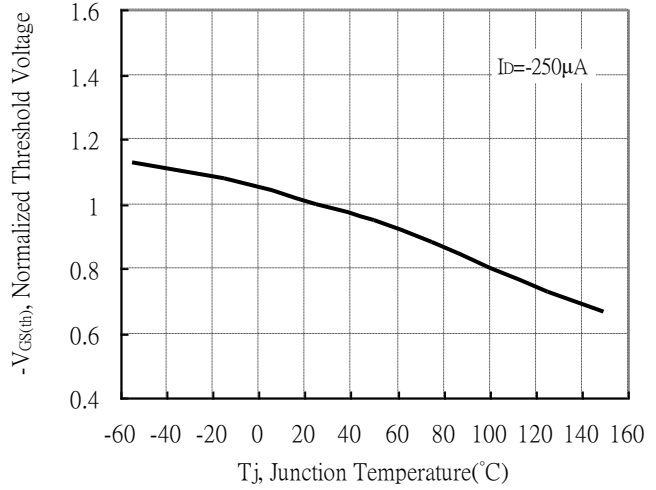

Single Pulse Power Rating, Junction to Ambient

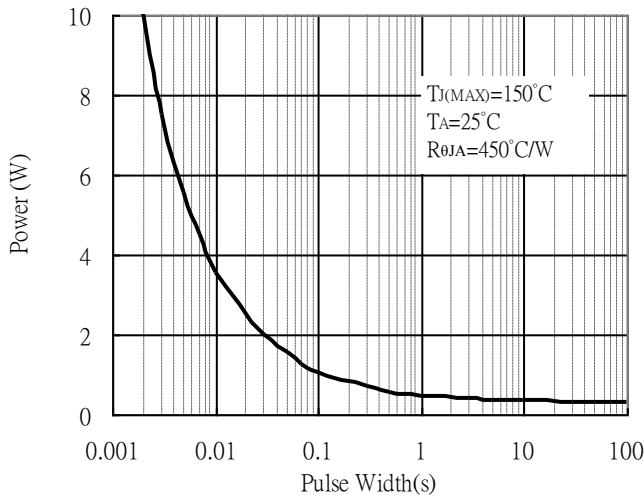

Gate Charge Characteristics

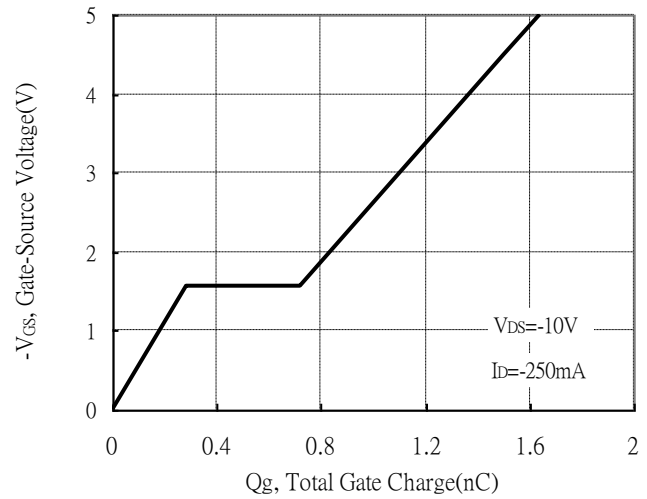

Maximum Safe Operating Area

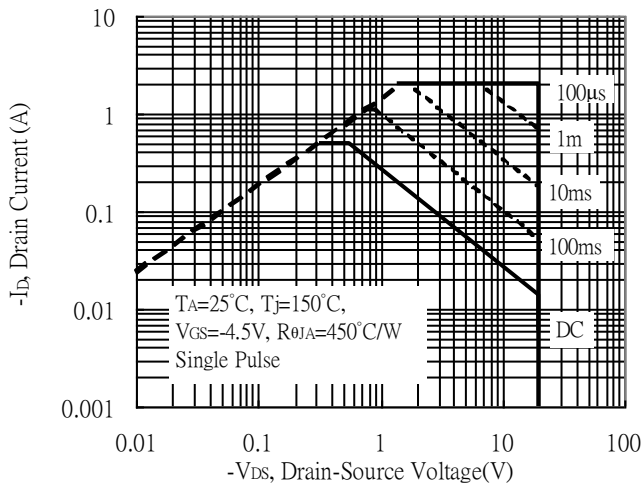

Maximum Drain Current vs Junction Temperature

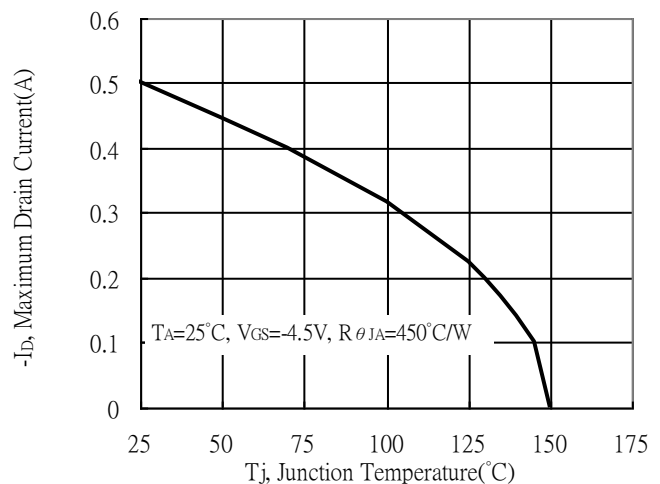

**Typical Characteristics(Cont.)**

Typical Transfer Characteristics

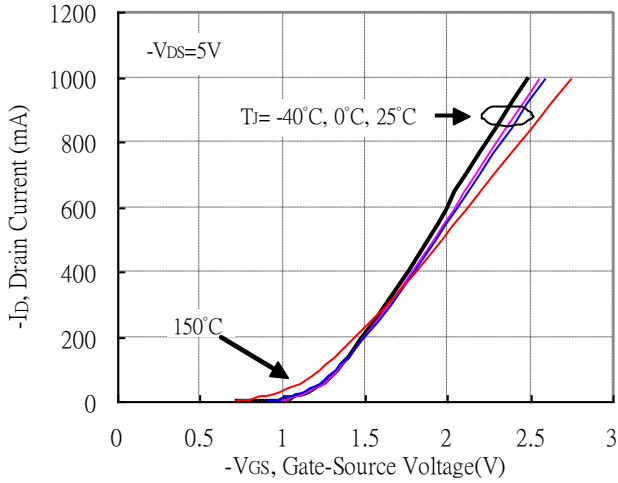

Power Derating Curve

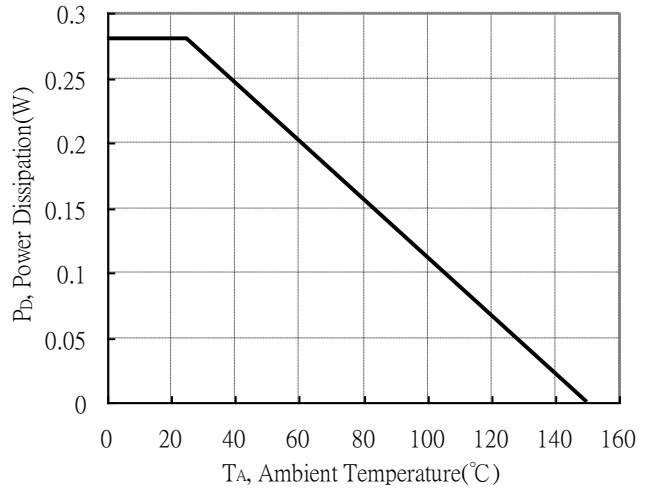

Transient Thermal Response Curves

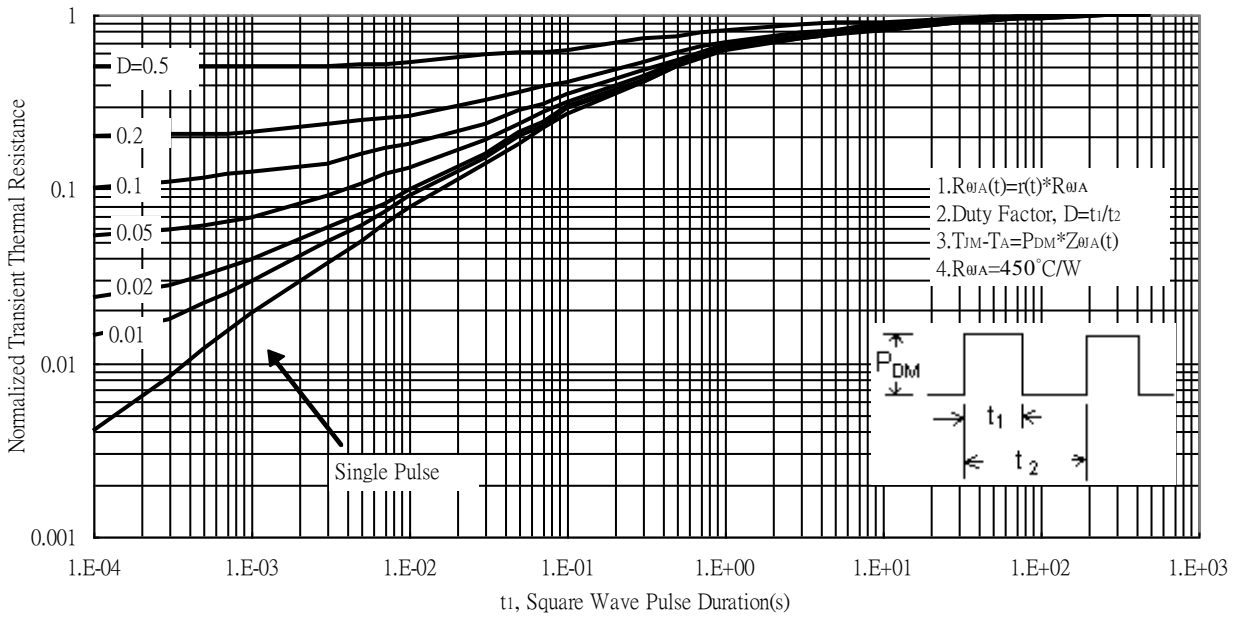

**Reel Dimension**

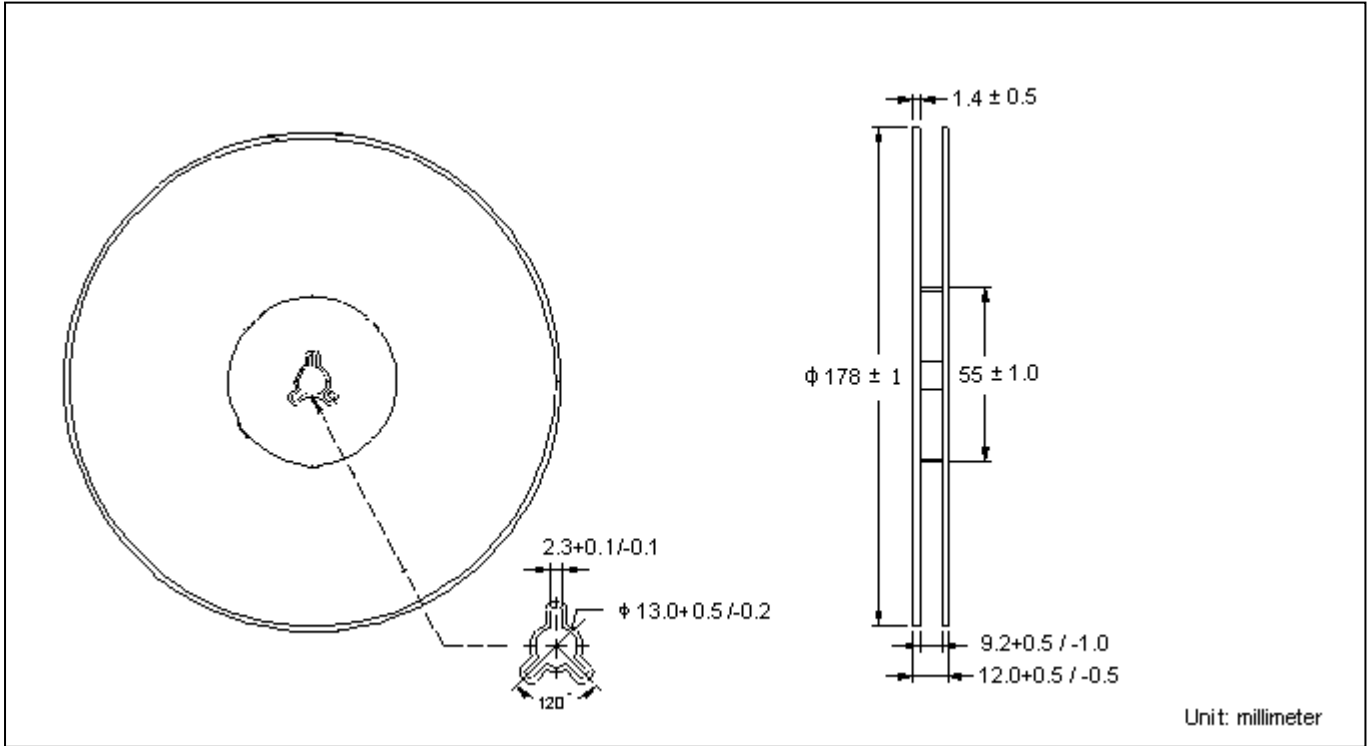

**Carrier Tape Dimension**

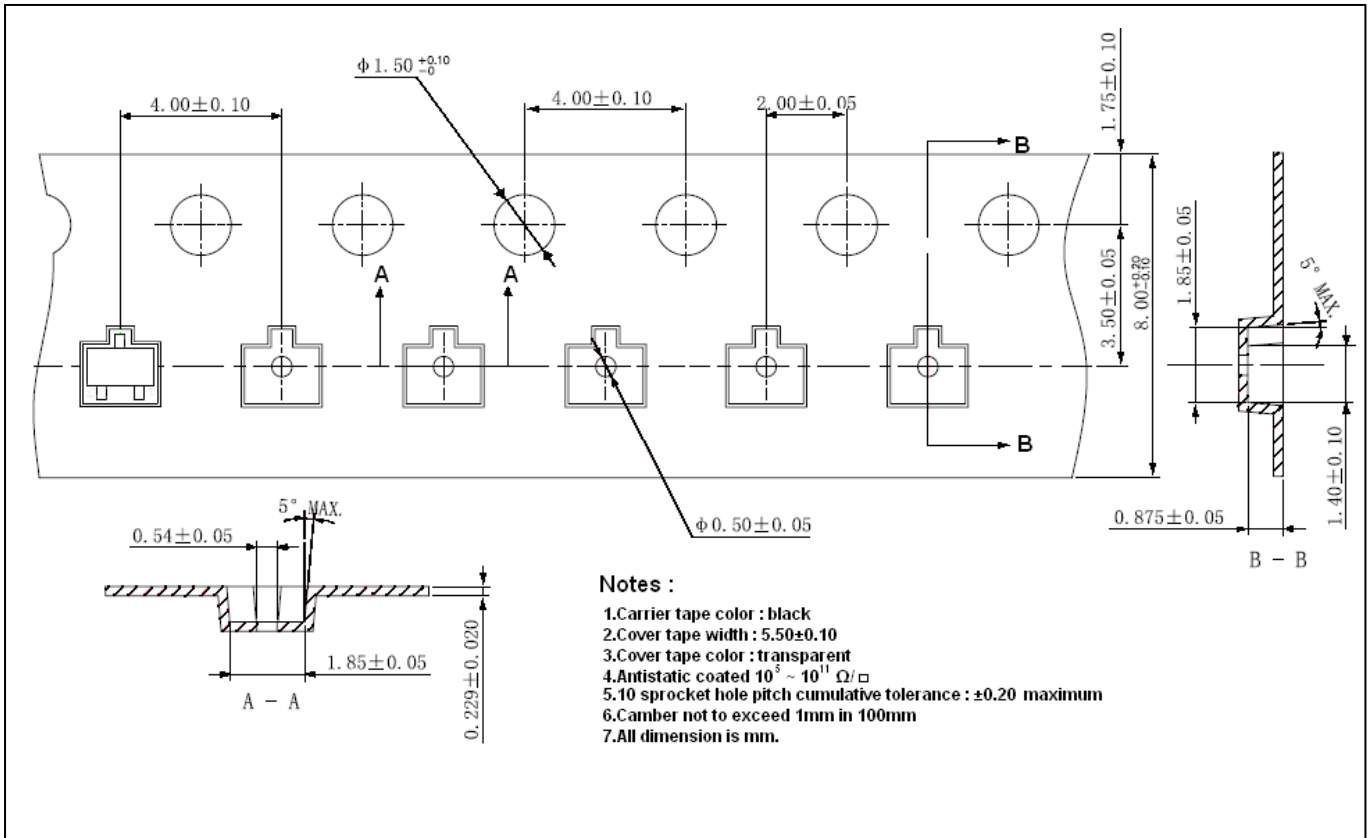

**Recommended wave soldering condition**

Product	Peak Temperature	Soldering Time
Pb-free devices	260 +0/-5 °C	5 +1/-1 seconds

**Recommended temperature profile for IR reflow**

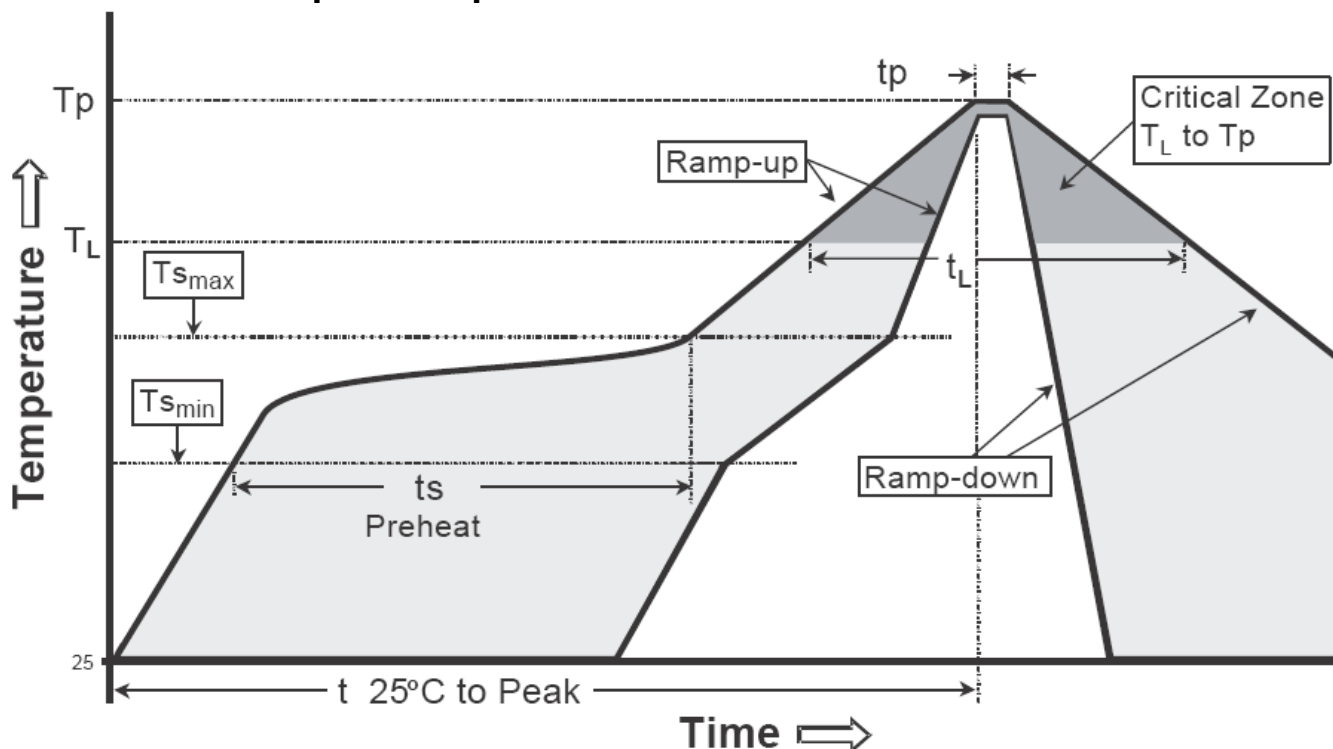

Profile feature	Sn-Pb eutectic Assembly	Pb-free Assembly
Average ramp-up rate (Tsmmax to Tp)	3°C/second max.	3°C/second max.
Preheat		
-Temperature Min(Ts min)	100°C	150°C
-Temperature Max(Ts max)	150°C	200°C
-Time(ts min to ts max)	60-120 seconds	60-180 seconds
Time maintained above:		
-Temperature (Tl)	183°C	217°C
- Time (tL)	60-150 seconds	60-150 seconds
Peak Temperature(TP)	240 +0/-5 °C	260 +0/-5 °C
Time within 5°C of actual peak temperature(tp)	10-30 seconds	20-40 seconds
Ramp down rate	6°C/second max.	6°C/second max.
Time 25 °C to peak temperature	6 minutes max.	8 minutes max.

Note : All temperatures refer to topside of the package, measured on the package body surface.

## SOT-523 Dimension

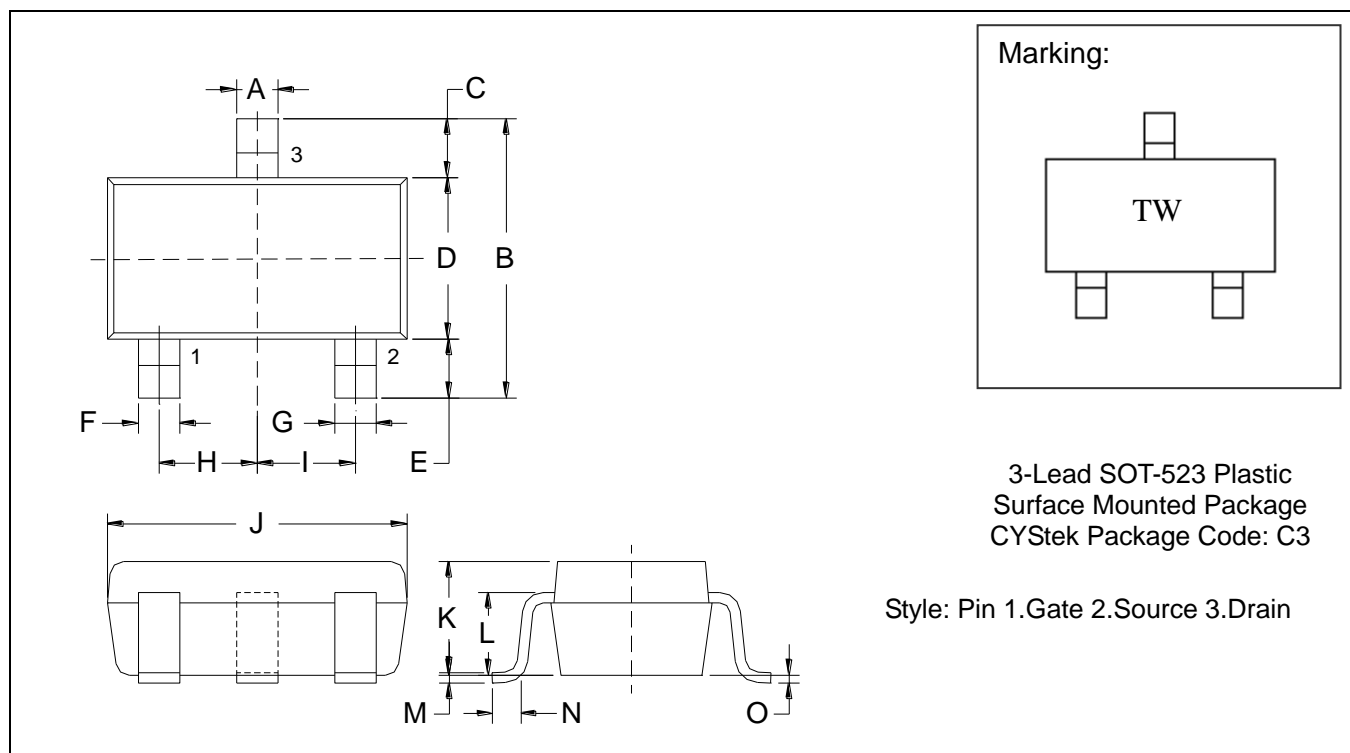

\*: Typical

DIM	Inches		Millimeters		DIM	Inches		Millimeters	
	Min.	Max.	Min.	Max.		Min.	Max.	Min.	Max.
A	0.0079	0.0157	0.20	0.40	I	*0.0197	-	*0.50	-
B	0.0591	0.0669	1.50	1.70	J	0.0610	0.0650	1.55	1.65
C	0.0118	0.0197	0.30	0.50	K	0.0276	0.0315	0.70	0.80
D	0.0295	0.0335	0.75	0.85	L	0.0224	0.0248	0.57	0.63
E	0.0118	0.0197	0.30	0.50	M	0.0020	0.0059	0.05	0.15
F	0.0039	0.0118	0.10	0.30	N	0.0039	0.0118	0.10	0.30
G	0.0039	0.0118	0.10	0.30	O	0	0.0031	0	0.08
H	*0.0197	-	*0.50	-					

Notes: 1. Controlling dimension: millimeters.

2. Maximum lead thickness includes lead finish thickness, and minimum lead thickness is the minimum thickness of base material.

3. If there is any question with packing specification or packing method, please contact your local CYStek sales office.

### Material:

- Lead: Pure tin plated.
- Mold Compound: Epoxy resin family, flammability solid burning class: UL94V-0

### Important Notice:

- All rights are reserved. Reproduction in whole or in part is prohibited without the prior written approval of CYStek.
- CYStek reserves the right to make changes to its products without notice.
- CYStek **semiconductor products are not warranted to be suitable for use in Life-Support Applications, or systems.**
- CYStek assumes no liability for any consequence of customer product design, infringement of patents, or application assistance.