

# Dual N- Channel Enhancement Mode MOSFET

## MTNN252504SH8

	Tr 1	Tr 2
$BV_{DSS}$	40V	40V
$I_D@V_{GS}=10V, T_A=25^\circ C$	6.2A	6.7A
$I_D@V_{GS}=10V, T_C=25^\circ C$	18.2A	21A
$R_{DS(on)(typ)}@V_{GS}=10V$	18.3m $\Omega$	18.3m $\Omega$
$R_{DS(on)(typ)}@V_{GS}=4.5V$	22.6m $\Omega$	22.6m $\Omega$

### Features

- Simple drive requirement
- Low on-resistance
- Fast switching speed
- Pb-free lead plating and halogen-free package

### Equivalent Circuit

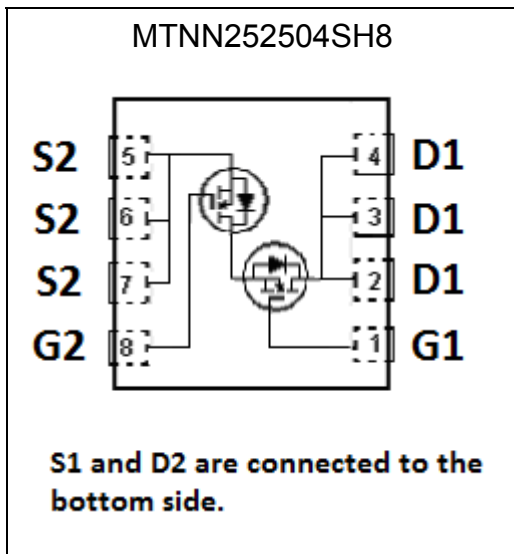

### Outline

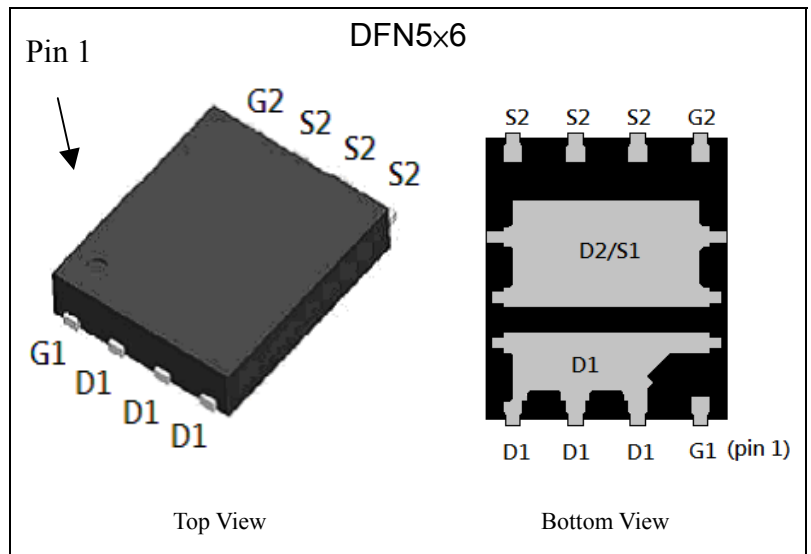

### Ordering Information

Device	Package	Shipping
MTNN252504SH8-0-T6-G	DFN 5 x 6 (Pb-free lead plating & halogen-free package)	3000 pcs / Tape & Reel

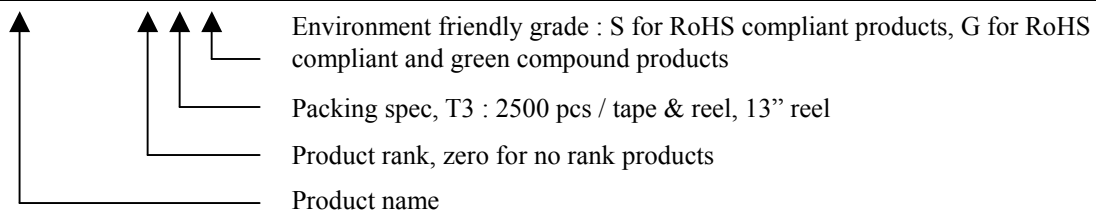



**Absolute Maximum Ratings** (T<sub>C</sub>=25°C, unless otherwise noted)

Parameter	Symbol	Limits		Unit	
		Tr 1	Tr 2		
Drain-Source Breakdown Voltage	BV <sub>DSS</sub>	40	40	V	
Gate-Source Voltage	V <sub>GS</sub>	±20	±20		
Continuous Drain Current	I <sub>D</sub>	TA=25 °C, VGS=10V	6.2	6.7	A
		TA=70 °C, VGS=10V	5.0	5.4	
		TC=25 °C, VGS=10V	18.2	21	
		TC=100 °C, VGS=10V	11.5	13.3	
Pulsed Drain Current (Note 1 & 2)	I <sub>DM</sub>	40	40		
Single Pulse Avalanche Current @ L=0.1mH	I <sub>AS</sub>	20	20		
Single Pulse Avalanche Energy (Note 4)	E <sub>AS</sub>	20	20	mJ	
Power Dissipation	P <sub>DSM</sub>	TA=25 °C	1.8	2.1	W
		TA=70 °C	1.2	1.3	
	P <sub>D</sub>	TC=25 °C	15.6	20.8	
		TC=100 °C	6.2	8.3	
Operating Junction and Storage Temperature Range	T <sub>j</sub> ; T <sub>stg</sub>	-55~+150		°C	

**Thermal Data**

Parameter	Symbol	Value		Unit
Thermal Resistance, Junction-to-case, max	R <sub>θJC</sub>	8	6	°C/W
Thermal Resistance, Junction-to-ambient, max	R <sub>θJA</sub>	70	60	
Thermal Resistance, Junction-to-ambient, max (Note 3)		40	32	

- Note :
1. Pulse width limited by maximum junction temperature
  2. Duty cycle ≤ 1%
  3. Surface mounted on 1 in<sup>2</sup> copper pad of FR-4 board, t ≤ 10s; 125°C/W when mounted on minimum copper pad.
  4. For Tr 1, 100% tested by conditions of L=0.1mH, V<sub>DD</sub>=15V, V<sub>GS</sub>=10V, I<sub>AS</sub>=6A; for Tr 2, 100% tested by conditions of L=0.1mH, V<sub>DD</sub>=15V, V<sub>GS</sub>=10V, I<sub>AS</sub>=6A

**Tr 1, Electrical Characteristics** (T<sub>C</sub>=25°C, unless otherwise specified)

Symbol	Min.	Typ.	Max.	Unit	Test Conditions
<b>Static</b>					
BV <sub>DSS</sub>	40	-	-	V	V <sub>GS</sub> =0V, I <sub>D</sub> =250μA
V <sub>GS(th)</sub>	1.0	-	2.5		V <sub>DS</sub> =V <sub>GS</sub> , I <sub>D</sub> =250μA
I <sub>GSS</sub>	-	-	±100	nA	V <sub>GS</sub> =±20V, V <sub>DS</sub> =0V
I <sub>DSS</sub>	-	-	1	μA	V <sub>DS</sub> =32V, V <sub>GS</sub> =0V
	-	-	25		V <sub>DS</sub> =30V, V <sub>GS</sub> =0V, T <sub>j</sub> =125°C
*R <sub>DS(ON)</sub>	-	18.3	25	mΩ	V <sub>GS</sub> =10V, I <sub>D</sub> =6A
	-	22.6	35		V <sub>GS</sub> =4.5V, I <sub>D</sub> =5A
*G <sub>FS</sub>	-	5	-	S	V <sub>DS</sub> =10V, I <sub>D</sub> =5A



Dynamic					
Ciss	-	502	-	pF	V <sub>DS</sub> =20V, V <sub>GS</sub> =0V, f=1MHz
Coss	-	48	-		
Crss	-	41	-		
*td(ON)	-	6.6	-	ns	V <sub>DS</sub> =20V, I <sub>D</sub> =6A, V <sub>GS</sub> =10V, R <sub>G</sub> =1 Ω
*tr	-	15.8	-		
*td(OFF)	-	26	-		
*tf	-	5.4	-		
*Qg(V <sub>GS</sub> =10V)	-	12.7	-	nC	V <sub>DS</sub> =20V, I <sub>D</sub> =6A, V <sub>GS</sub> =10V
*Qg(V <sub>GS</sub> =4.5V)	-	6.4	-		
*Qgs	-	1.7	-		
*Qgd	-	2.6	-		
Body Diode					
*V <sub>SD</sub>	-	0.76	1.2	V	V <sub>GS</sub> =0V, I <sub>S</sub> =1A
*trr	-	8.3	-	ns	I <sub>F</sub> =1A, dI <sub>F</sub> /dt=100A/μs
*Qrr	-	3.6	-	nC	

\*Pulse Test : Pulse Width ≤300μs, Duty Cycle≤2%

**Tr 2, Electrical Characteristics (T<sub>c</sub>=25°C, unless otherwise specified)**

Symbol	Min.	Typ.	Max.	Unit	Test Conditions
Static					
BV <sub>DSS</sub>	40	-	-	V	V <sub>GS</sub> =0V, I <sub>D</sub> =250μA
V <sub>GS(th)</sub>	1.0	-	2.5		V <sub>DS</sub> =V <sub>GS</sub> , I <sub>D</sub> =250μA
I <sub>GSS</sub>	-	-	±100	nA	V <sub>GS</sub> =±20V, V <sub>DS</sub> =0V
I <sub>DSS</sub>	-	-	1	μA	V <sub>DS</sub> =32V, V <sub>GS</sub> =0V
	-	-	25		V <sub>DS</sub> =30V, V <sub>GS</sub> =0V, T <sub>j</sub> =125°C
*R <sub>D(S)ON</sub>	-	18.3	25	mΩ	V <sub>GS</sub> =10V, I <sub>D</sub> =6A
	-	22.6	35		V <sub>GS</sub> =4.5V, I <sub>D</sub> =5A
*G <sub>FS</sub>	-	5	-	S	V <sub>DS</sub> =10V, I <sub>D</sub> =5A
Dynamic					
Ciss	-	502	-	pF	V <sub>DS</sub> =20V, V <sub>GS</sub> =0V, f=1MHz
Coss	-	48	-		
Crss	-	41	-		
*td(ON)	-	6.6	-	ns	V <sub>DS</sub> =20V, I <sub>D</sub> =6A, V <sub>GS</sub> =10V, R <sub>G</sub> =1 Ω
*tr	-	15.8	-		
*td(OFF)	-	26	-		
*tf	-	5.4	-		
*Qg(V <sub>GS</sub> =10V)	-	12.7	-	nC	V <sub>DS</sub> =20V, I <sub>D</sub> =6A, V <sub>GS</sub> =10V
*Qg(V <sub>GS</sub> =4.5V)	-	6.4	-		
*Qgs	-	1.7	-		
*Qgd	-	2.6	-		
Body Diode					
*V <sub>SD</sub>	-	0.76	1	V	V <sub>GS</sub> =0V, I <sub>S</sub> =1A
*trr	-	8.3	-	ns	I <sub>F</sub> =1A, dI <sub>F</sub> /dt=100A/μs
*Qrr	-	3.6	-	nC	

\*Pulse Test : Pulse Width ≤300μs, Duty Cycle≤2%

**Recommended Soldering Footprint**

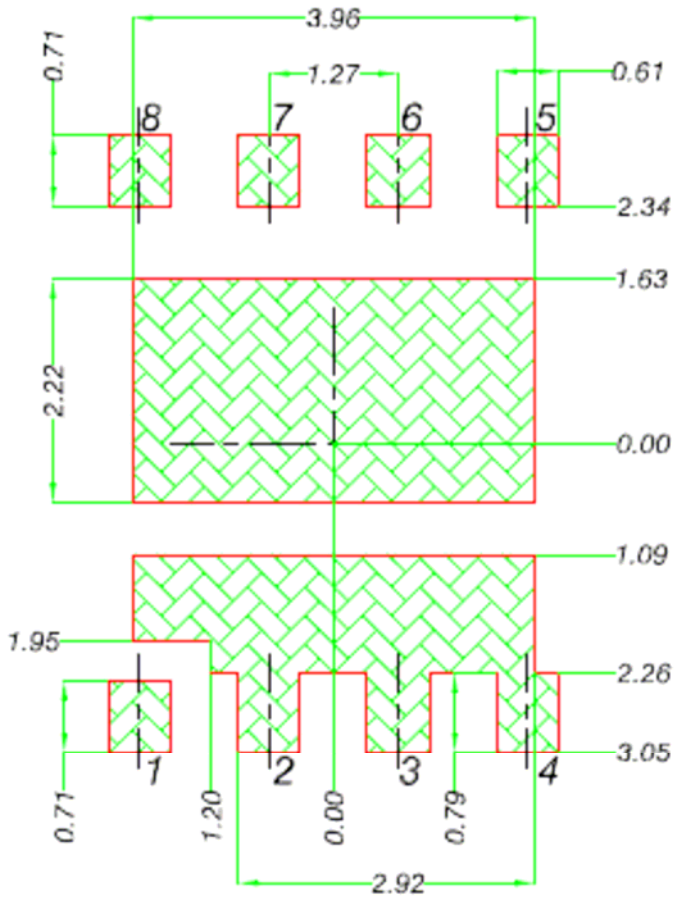

unit : mm



**Typical Characteristics : Q1( N-channel )**

Typical Output Characteristics

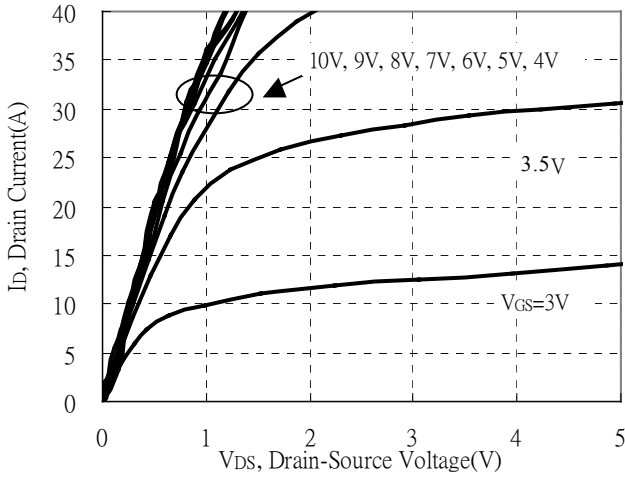

Brekdown Voltage vs Ambient Temperature

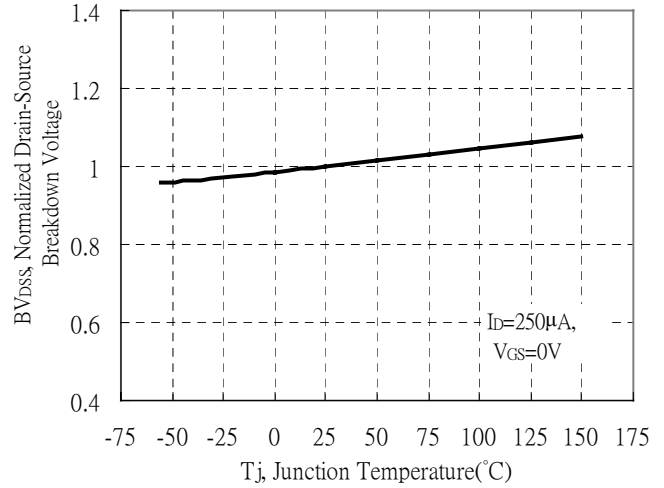

Static Drain-Source On-State resistance vs Drain Current

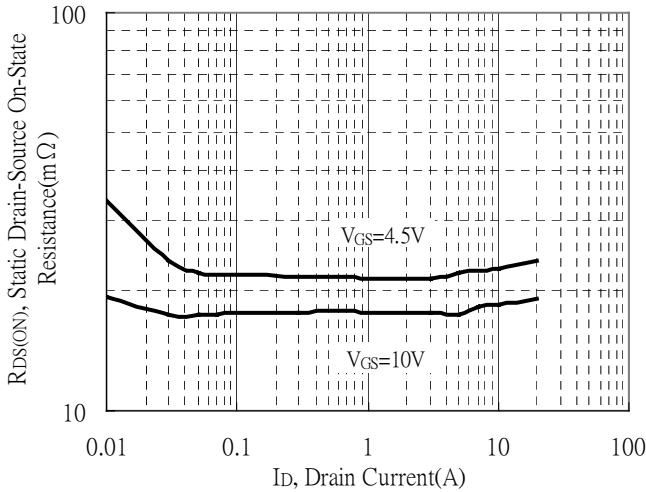

Reverse Drain Current vs Source-Drain Voltage

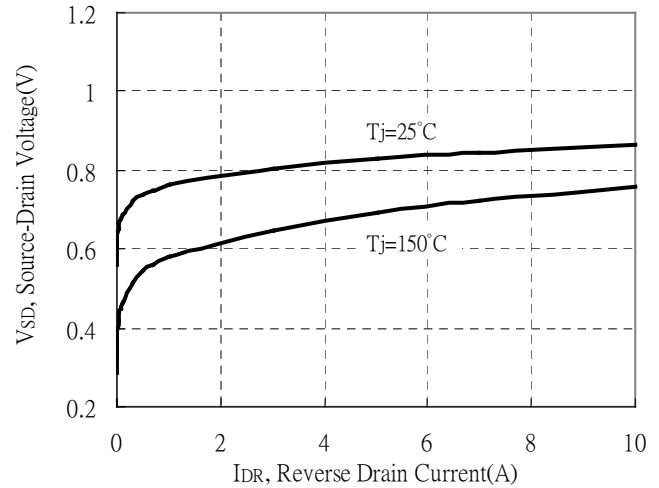

Static Drain-Source On-State Resistance vs Gate-Source Voltage

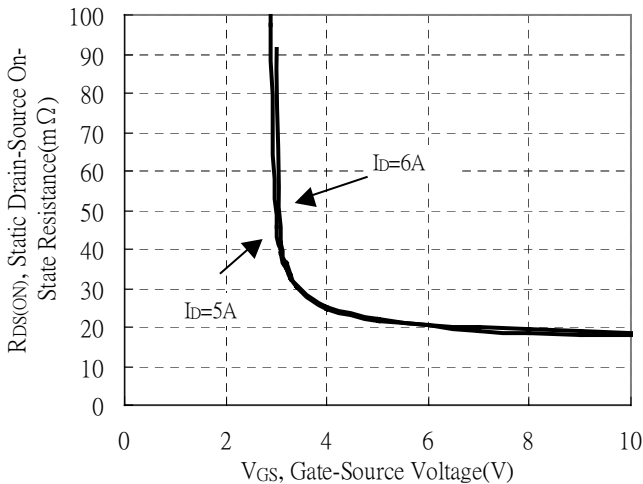

Drain-Source On-State Resistance vs Junction Temperature

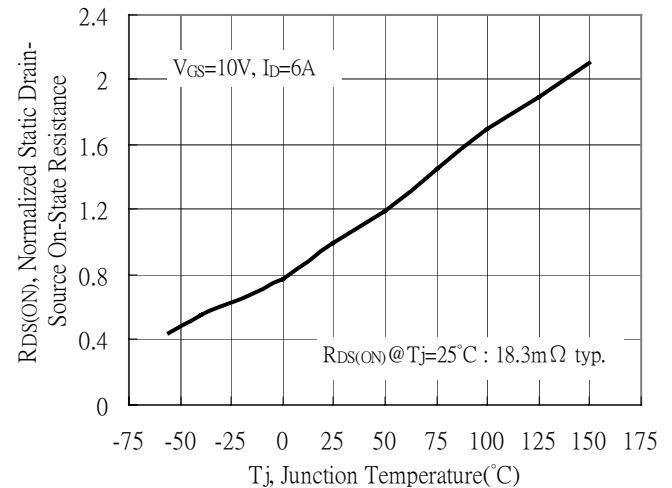

**Typical Characteristics(Cont.) : Q1( N-channel)**

Capacitance vs Drain-to-Source Voltage

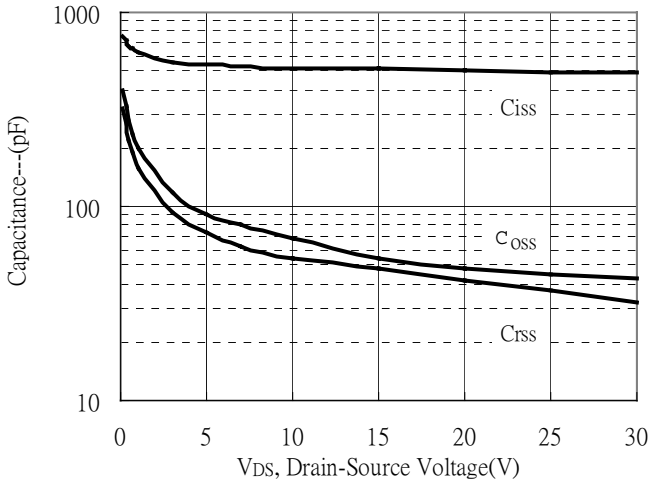

Threshold Voltage vs Junction Temperature

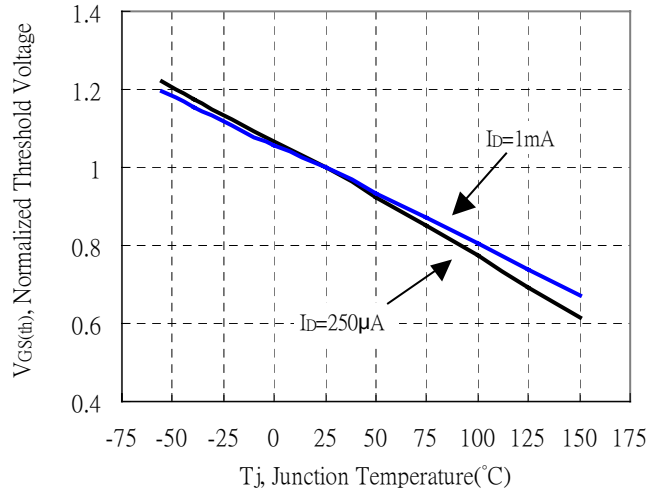

Forward Transfer Admittance vs Drain Current

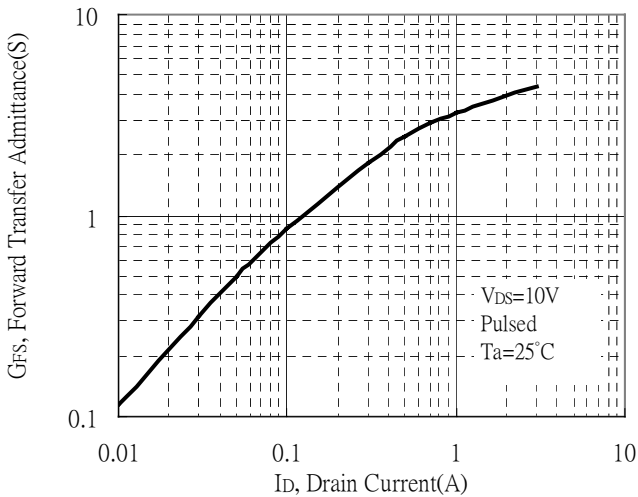

Gate Charge Characteristics

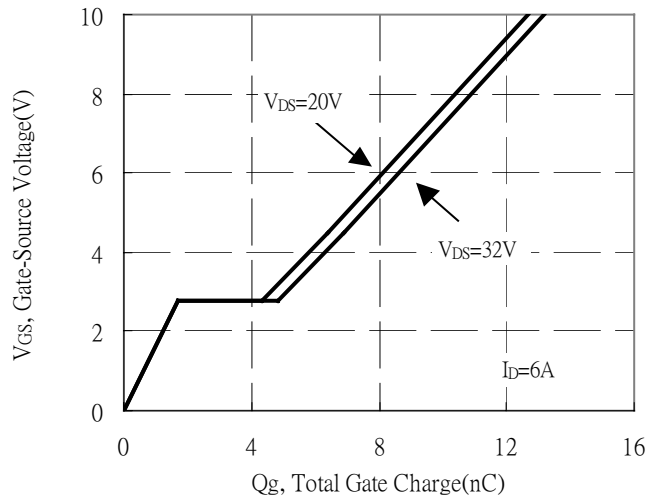

Maximum Safe Operating Area

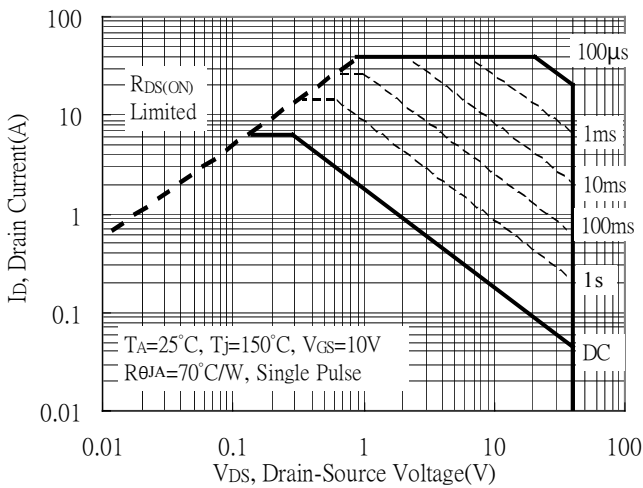

Maximum Drain Current vs Junction Temperature

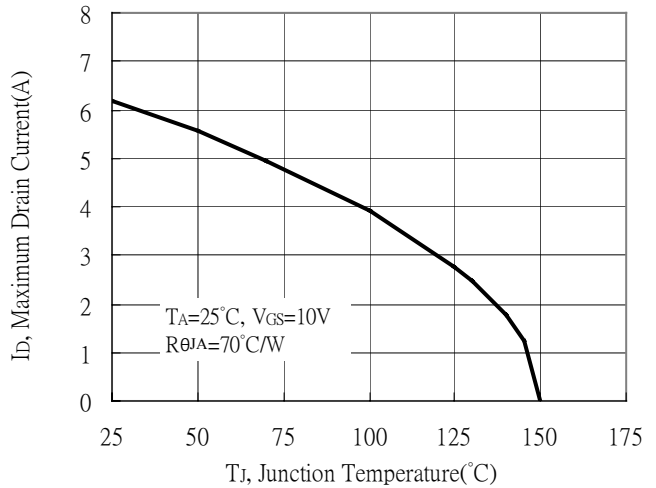



### Typical Characteristics(Cont.) : Q1( N-channel)

Single Pulse Power Rating, Junction to Ambient  
(Note on page 2)

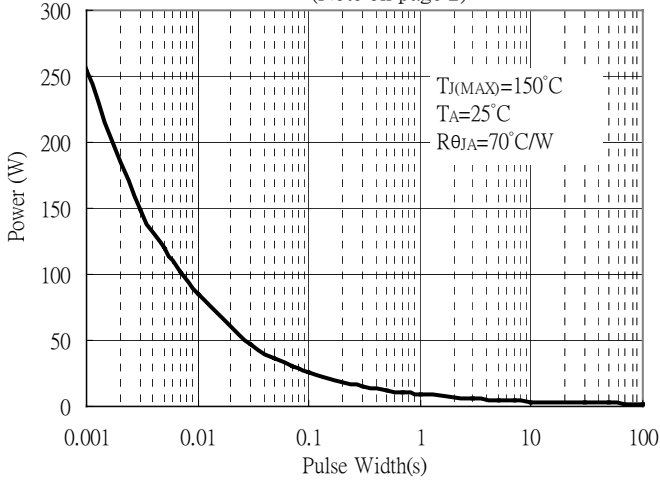

Typical Transfer Characteristics

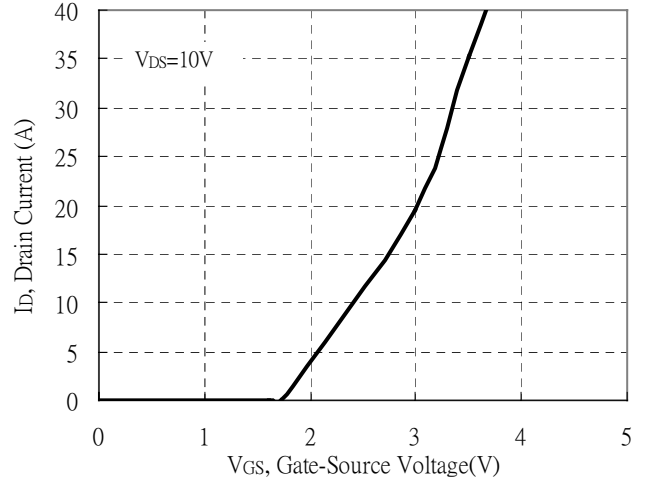

Transient Thermal Response Curves

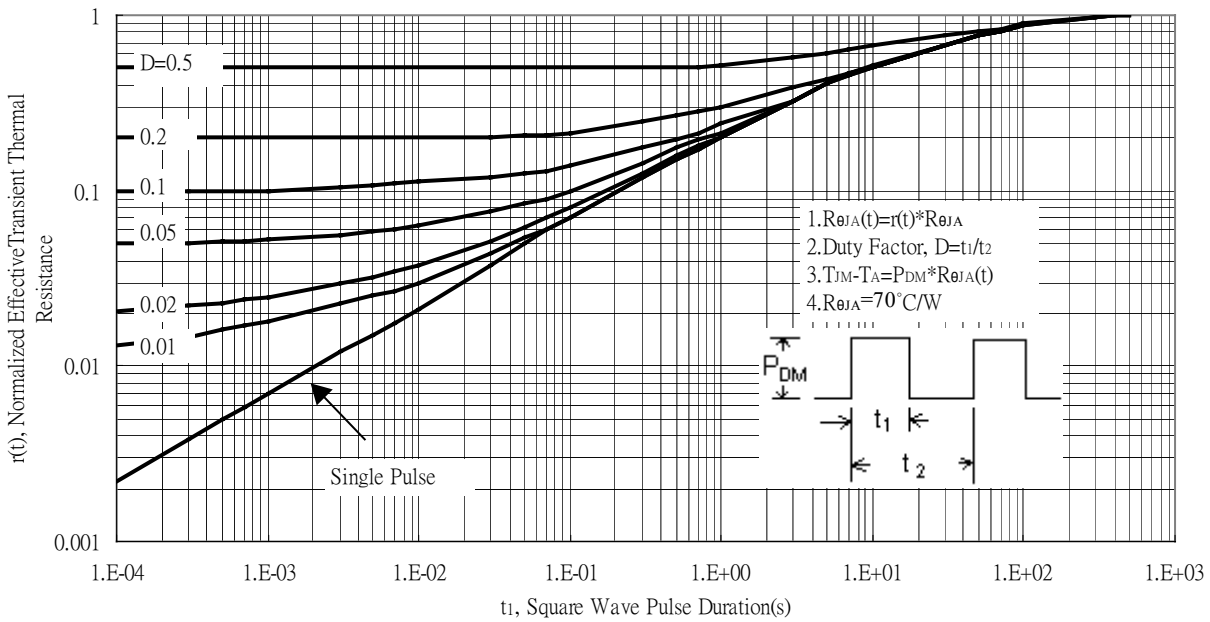



**Typical Characteristics : Q2( N-channel)**

Typical Output Characteristics

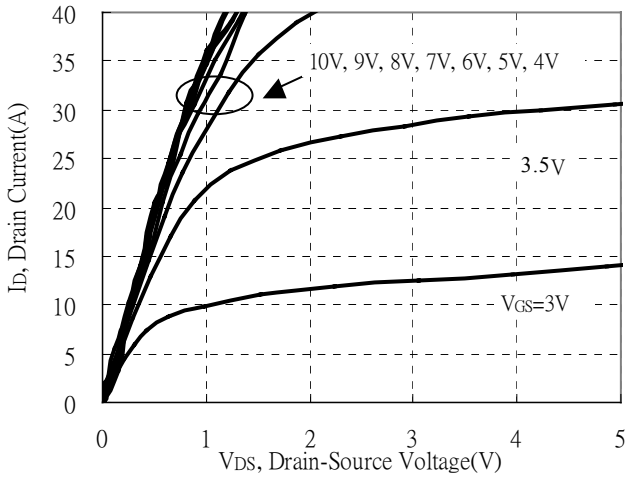

Breakdown Voltage vs Ambient Temperature

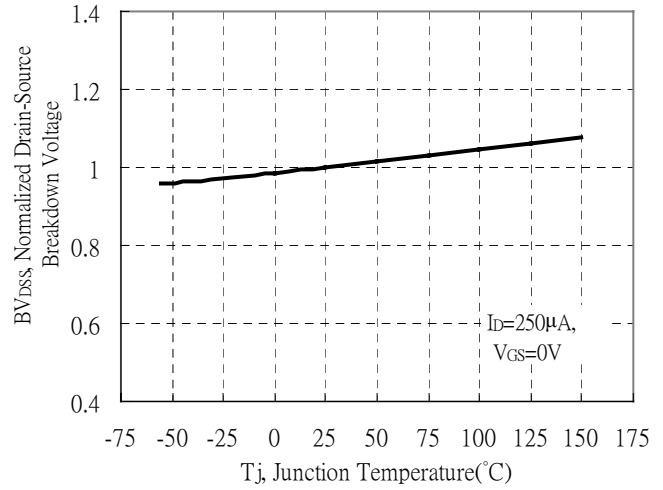

Static Drain-Source On-State resistance vs Drain Current

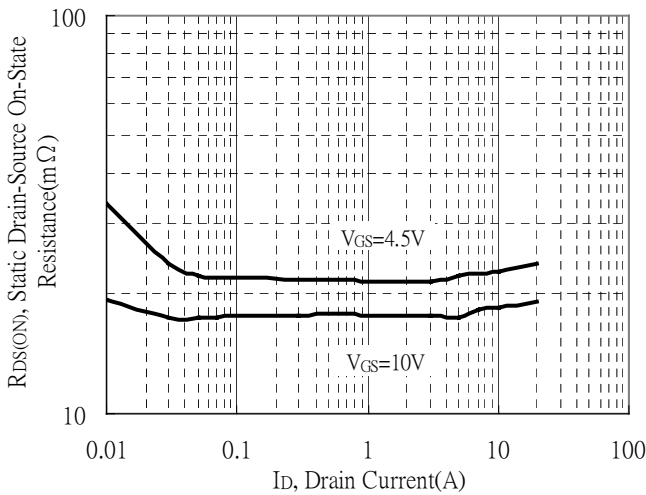

Reverse Drain Current vs Source-Drain Voltage

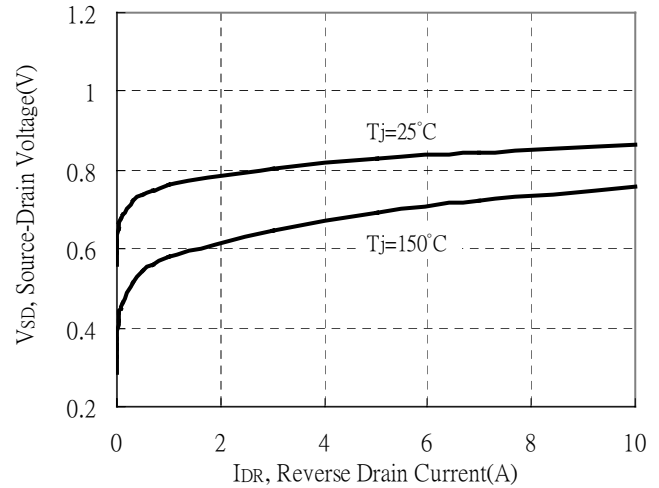

Static Drain-Source On-State Resistance vs Gate-Source Voltage

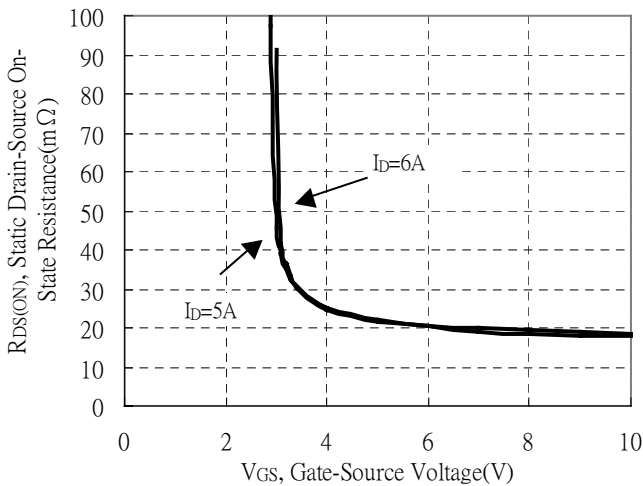

Drain-Source On-State Resistance vs Junction Temperature

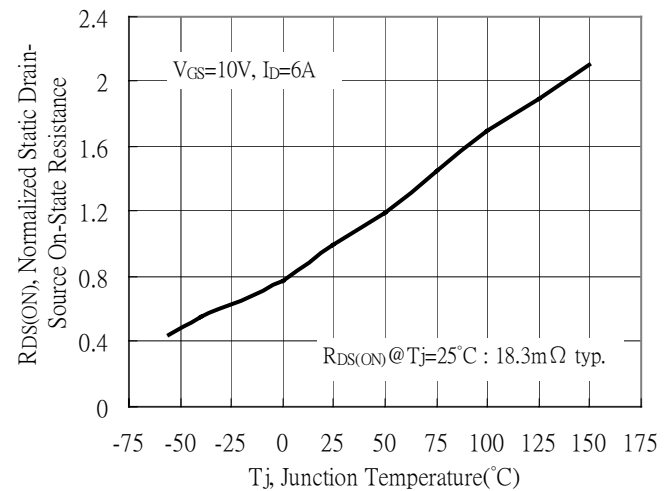



**Typical Characteristics(Cont.) : Q2(N-channel)**

Capacitance vs Drain-to-Source Voltage

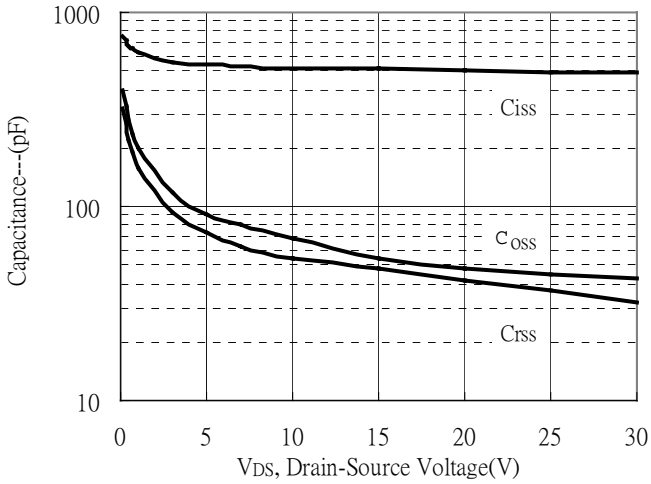

Threshold Voltage vs Junction Temperature

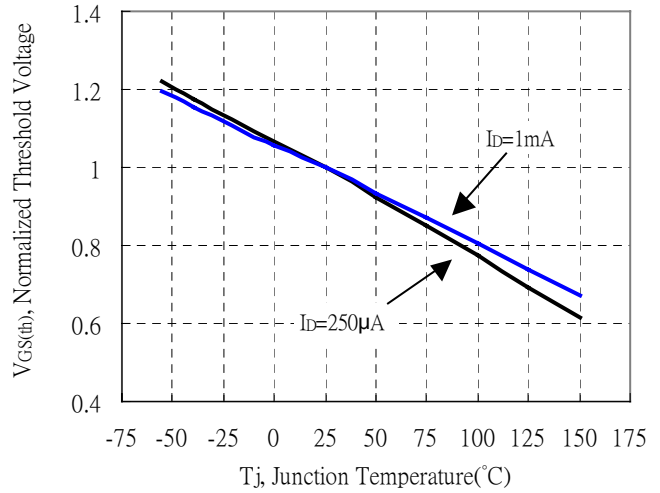

Forward Transfer Admittance vs Drain Current

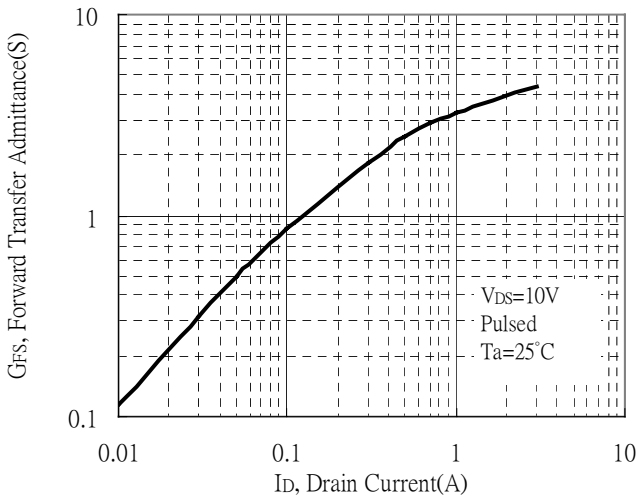

Gate Charge Characteristics

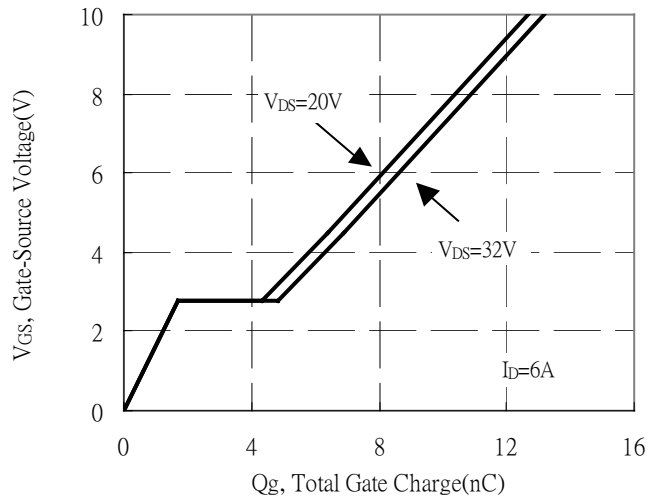

Maximum Safe Operating Area

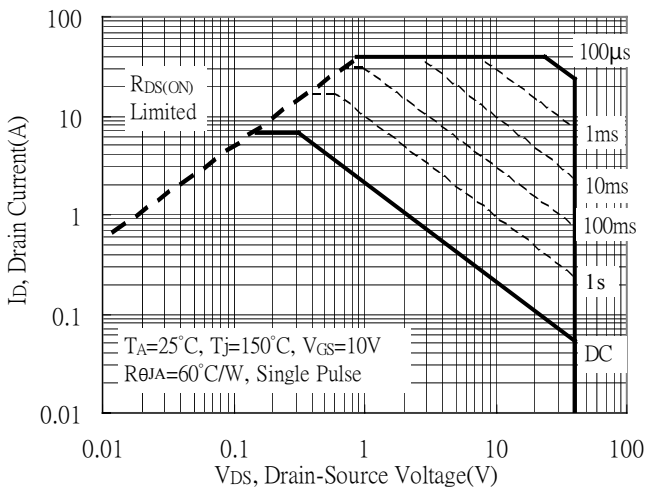

Maximum Drain Current vs Junction Temperature

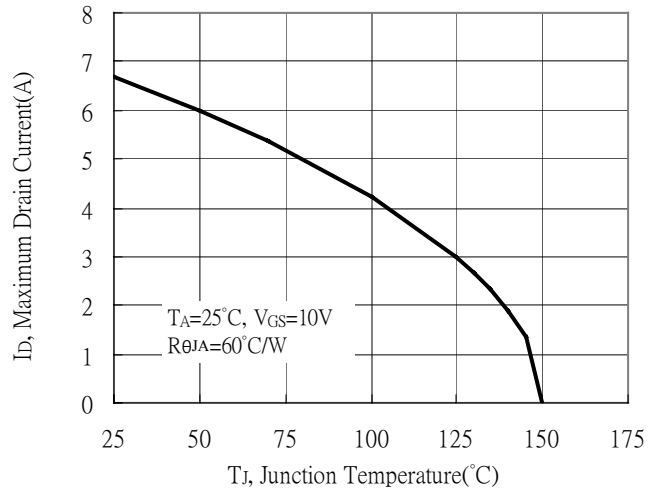

**Typical Characteristics(Cont.) : Q2(N-channel)**

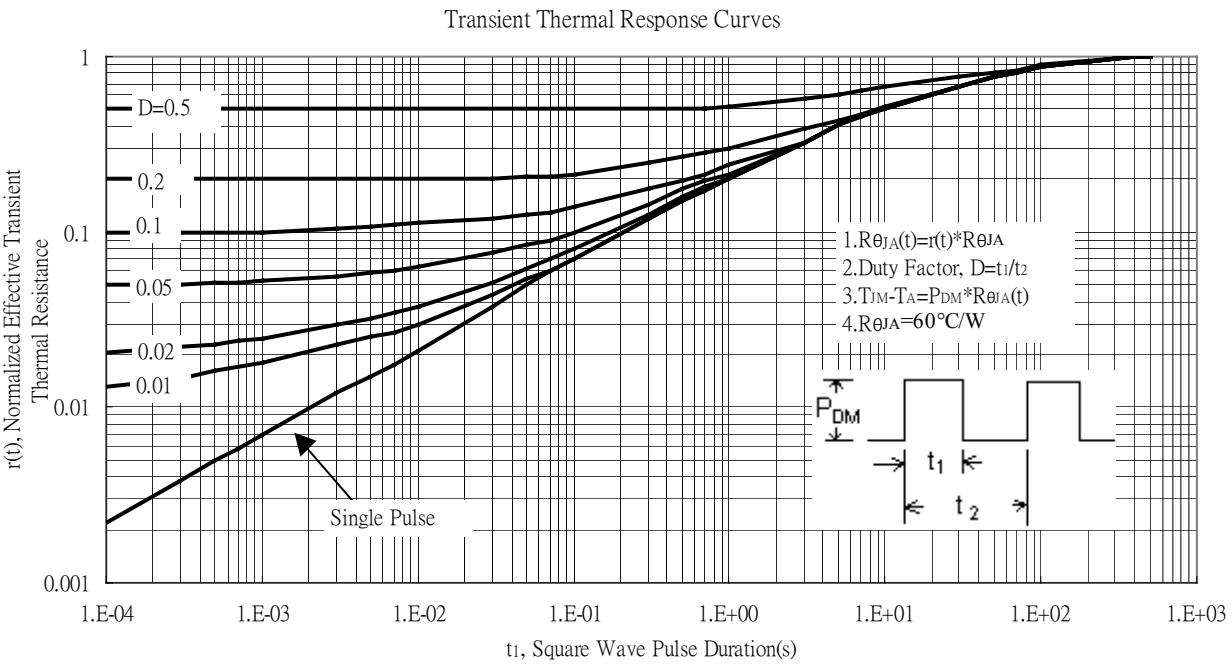
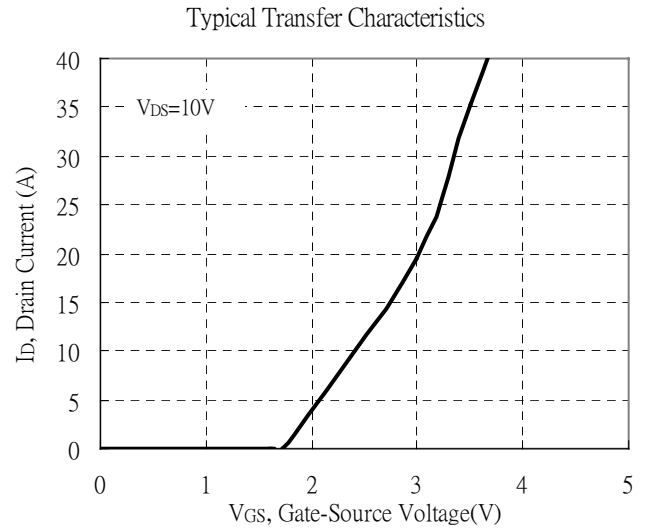
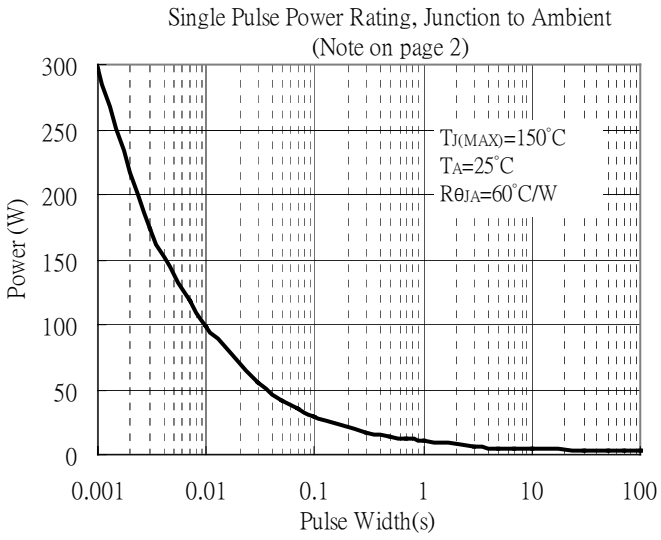

**Reel Dimension**

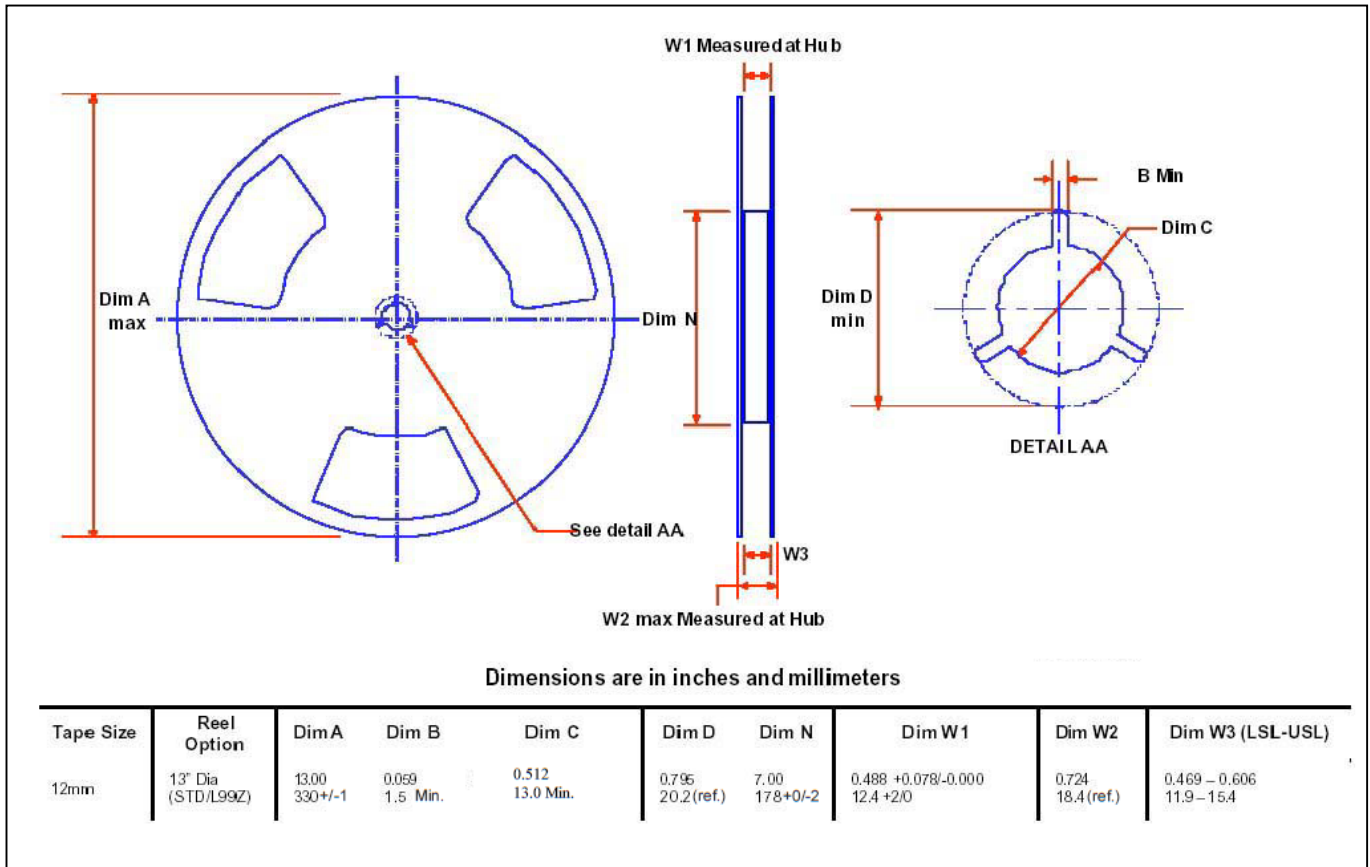

**Carrier Tape Dimension**

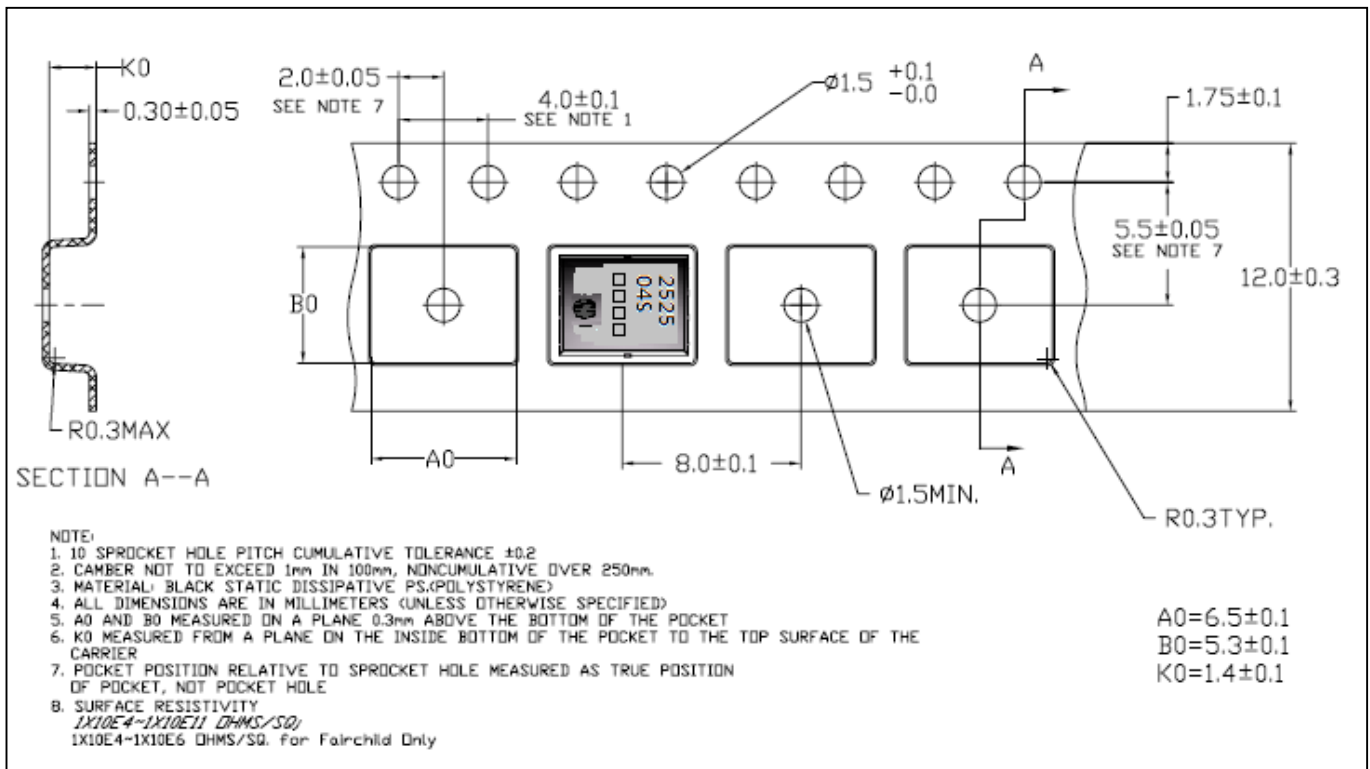

**Recommended wave soldering condition**

Product	Peak Temperature	Soldering Time
Pb-free devices	260 +0/-5 °C	5 +1/-1 seconds

**Recommended temperature profile for IR reflow**

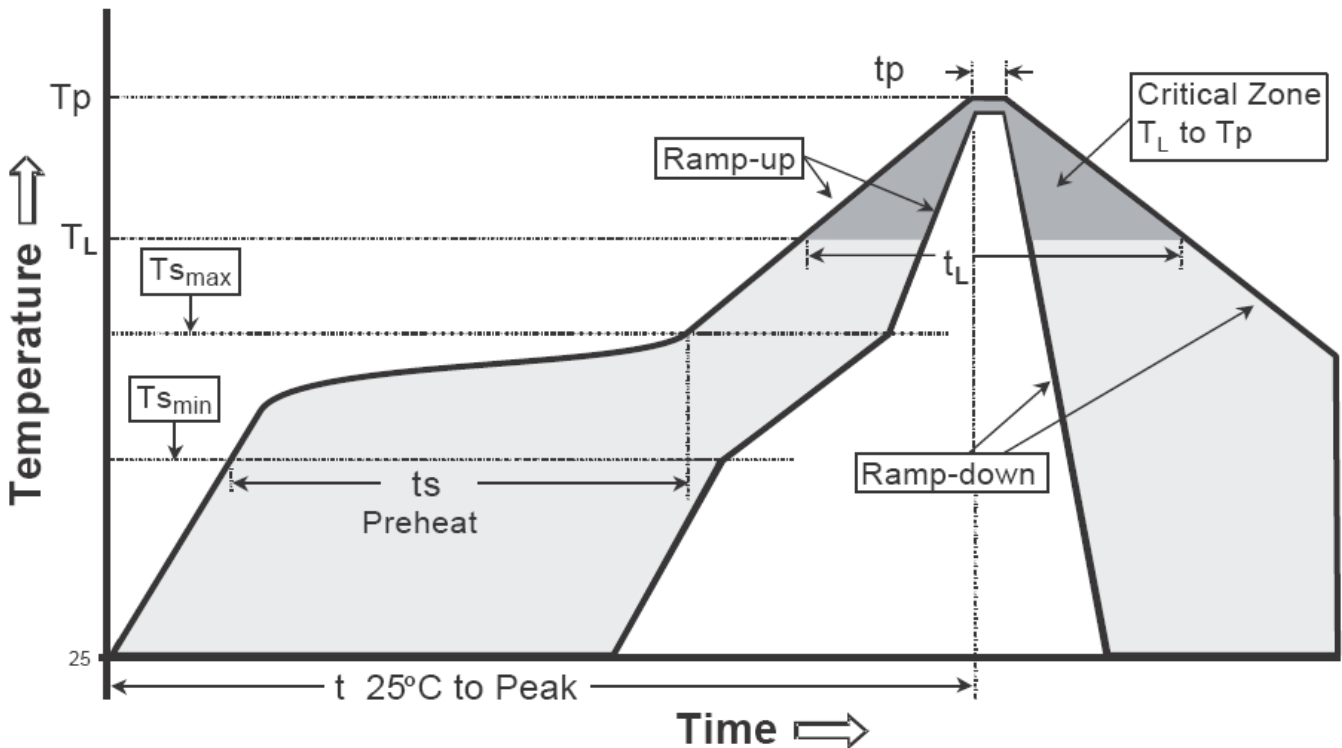

Profile feature	Sn-Pb eutectic Assembly	Pb-free Assembly
Average ramp-up rate (Tsmax to Tp)	3°C/second max.	3°C/second max.
Preheat		
-Temperature Min(Ts min)	100°C	150°C
-Temperature Max(Ts max)	150°C	200°C
-Time(ts min to ts max)	60-120 seconds	60-180 seconds
Time maintained above:		
-Temperature (TL)	183°C	217°C
- Time (tL)	60-150 seconds	60-150 seconds
Peak Temperature(TP)	240 +0/-5 °C	260 +0/-5 °C
Time within 5°C of actual peak temperature(tp)	10-30 seconds	20-40 seconds
Ramp down rate	6°C/second max.	6°C/second max.
Time 25 °C to peak temperature	6 minutes max.	8 minutes max.

Note : All temperatures refer to topside of the package, measured on the package body surface.

**DFN5x6 Dimension**

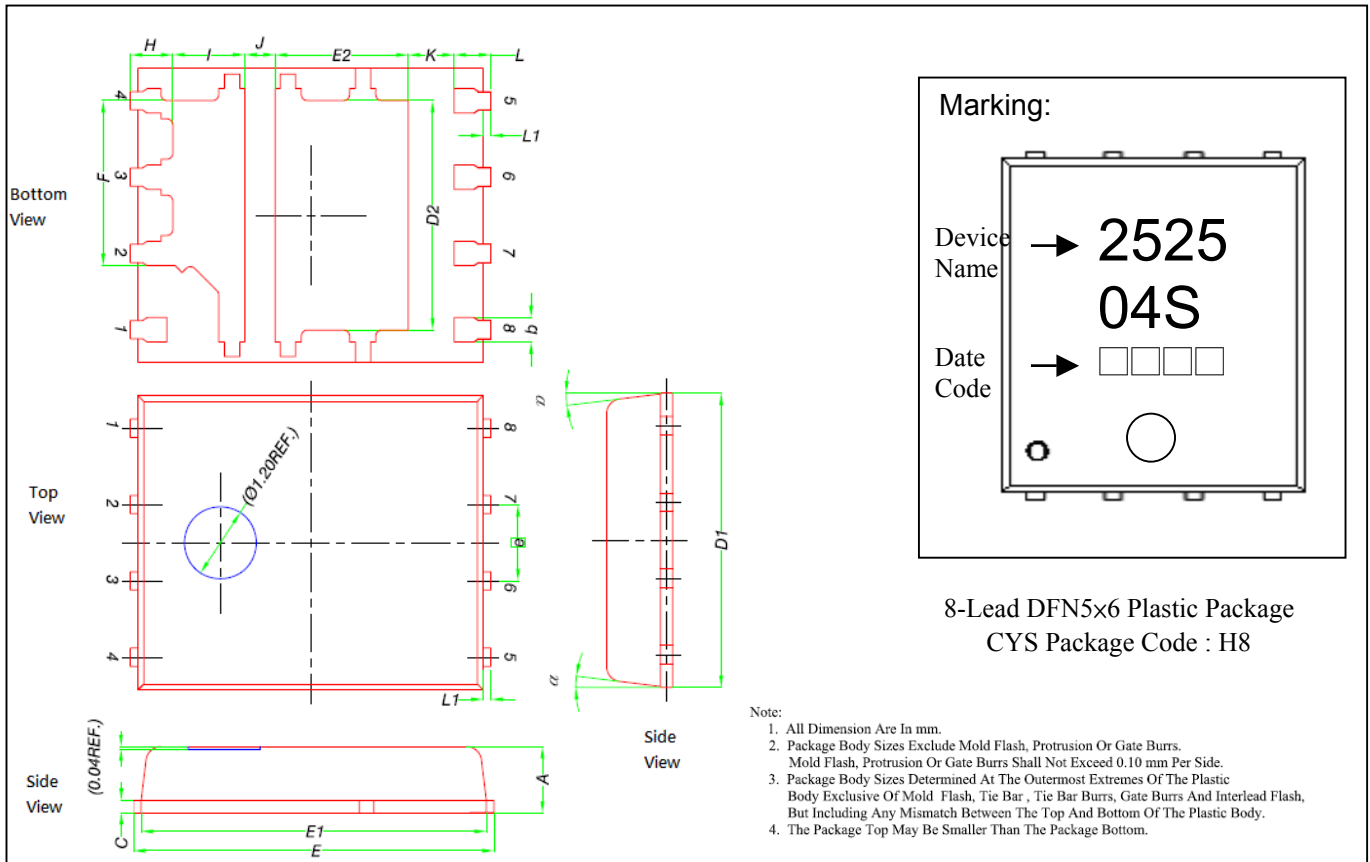

DIM	Millimeters		Inches		DIM	Millimeters		Inches	
	Min.	Max.	Min.	Max.		Min.	Max.	Min.	Max.
A	0.90	1.10	0.035	0.043	F	2.55	2.90	0.100	0.114
b	0.33	0.51	0.013	0.020	H	0.61	0.81	0.024	0.032
C	0.20	0.30	0.008	0.012	I	1.10	1.30	0.043	0.051
D1	4.80	5.00	0.189	0.197	J	0.40	0.60	0.016	0.024
D2	3.61	3.96	0.142	0.156	K	0.50	-	0.020	-
E	5.90	6.10	0.232	0.240	L	0.51	0.71	0.020	0.028
E1	5.70	5.80	0.224	0.228	L1	0.06	0.20	0.002	0.008
E2	2.02	2.42	0.080	0.095	$\alpha$	0°	12°	0°	12°
$\square$	1.27 BSC		0.050 BSC						

**Notes:** 1.Controlling dimension: millimeters.  
 2.Maximum lead thickness includes lead finish thickness, and minimum lead thickness is the minimum thickness of base material.  
 3.If there is any question with packing specification or packing method, please contact your local CYStek sales office.

**Material:**

- Lead: Pure tin plated.
- Mold Compound: Epoxy resin family, flammability solid burning class: UL94V-0.

**Important Notice:**

- All rights are reserved. Reproduction in whole or in part is prohibited without the prior written approval of CYStek.
- CYStek reserves the right to make changes to its products without notice.
- CYStek **semiconductor products are not warranted to be suitable for use in Life-Support Applications, or systems.**
- CYStek assumes no liability for any consequence of customer product design, infringement of patents, or application assistance.