



## N-Channel Enhancement Mode Power MOSFET

# MTN10N70FP

$BV_{DSS}$	700V
$I_D @ V_{GS}=10V, T_C=25^\circ C$	10A
$R_{DS(on)(TYP)} @ V_{GS}=10V, I_D=5A$	0.66Ω

### Description

The MTN10N70FP is a N-channel enhancement-mode MOSFET, providing the designer with the best combination of fast switching, ruggedized device design, low on-resistance and cost effectiveness. The TO-220FP package is universally preferred for all commercial-industrial applications

### Features

- Low On Resistance
- Simple Drive Requirement
- Low Gate Charge
- Fast Switching Characteristic
- Insulating package, front/back side insulating voltage=2500V(AC)
- RoHS compliant package

### Applications

- Open Framed Power Supply
- Adapter
- STB

### Ordering Information

Device	Package	Shipping
MTN10N70FP-0-UB-S	TO-220FP (RoHS compliant package)	50 pcs/tube, 20 tubes/box, 4 boxes / carton

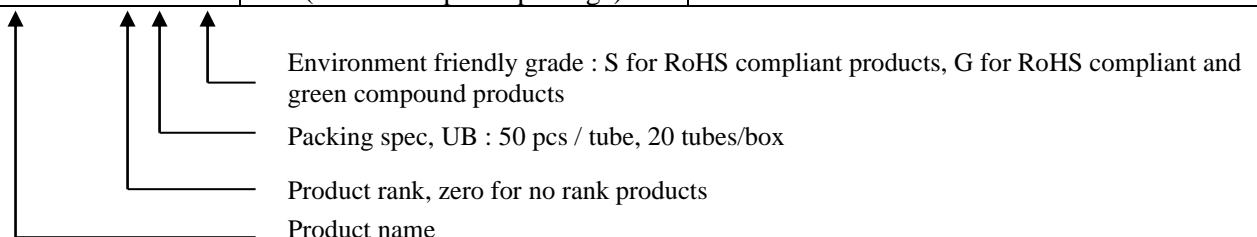

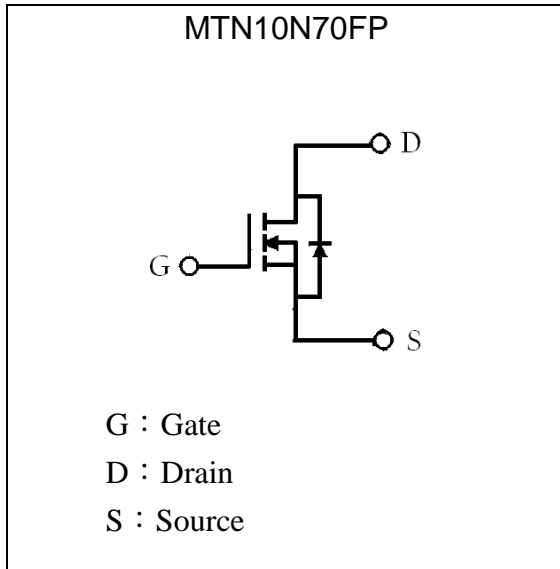
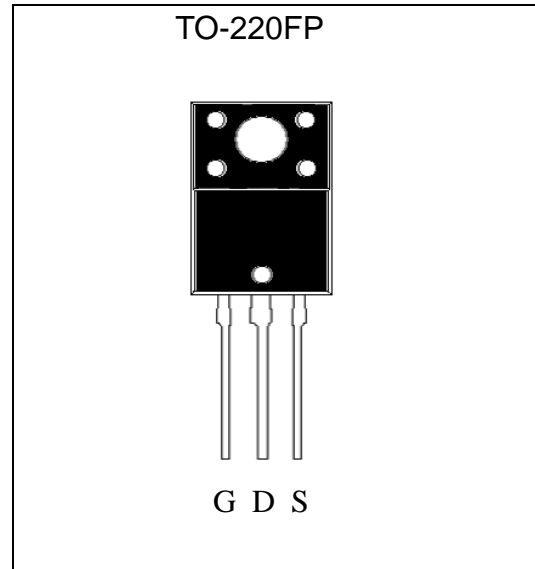
**Symbol**

**Outline**

**Absolute Maximum Ratings** ( $T_C=25^\circ\text{C}$ )

Parameter	Symbol	Limits	Unit
Drain-Source Voltage	$V_{DS}$	700	V
Gate-Source Voltage	$V_{GS}$	$\pm 30$	
Continuous Drain Current	$I_D$	10*	A
Continuous Drain Current @ $T_C=100^\circ\text{C}$		6.3*	
Pulsed Drain Current @ $V_{GS}=10\text{V}$ (Note 1)		$I_{DM}$	
Avalanche Current (Note 1)	$I_{AS}$	8	mJ
Single Pulse Avalanche Energy (Note 2)	$E_{AS}$	320	
Repetitive Avalanche Energy (Note 1)	$E_{AR}$	6	
Maximum Temperature for Soldering @ Lead at 0.125 in(0.318mm) from case for 10 seconds	$T_L$	300	$^\circ\text{C}$
Total Power Dissipation ( $T_C=25^\circ\text{C}$ )	$P_D$	66	W
Linear Derating Factor		0.53	W/ $^\circ\text{C}$
Operating Junction and Storage Temperature	$T_j, T_{stg}$	-55~+150	$^\circ\text{C}$

\*Drain current limited by maximum junction temperature

\*100% UIS testing in condition of  $V_D=50\text{V}$ ,  $L=2\text{mH}$ ,  $V_G=10\text{V}$ ,  $I_L=6\text{A}$ , Rated  $V_{DS}=700\text{V}$

Note : 1.Repetitive rating; pulse width limited by maximum junction temperature.

2.  $I_{AS}=8\text{A}$ ,  $V_{DD}=50\text{V}$ ,  $L=10\text{mH}$ ,  $V_{GS}=10\text{V}$ , starting  $T_J=+25^\circ\text{C}$ .



**Thermal Data**

Parameter	Symbol	Value	Unit
Thermal Resistance, Junction-to-case, max	R <sub>θJC</sub>	1.9	°C/W
Thermal Resistance, Junction-to-ambient, max	R <sub>θJA</sub>	62.5	

**Characteristics (T<sub>c</sub>=25°C, unless otherwise specified)**

Symbol	Min.	Typ.	Max.	Unit	Test Conditions
<b>Static</b>					
BV <sub>DSS</sub>	700	-	-	V	V <sub>GS</sub> =0V, I <sub>D</sub> =250μA, T <sub>j</sub> =25°C
ΔBV <sub>DSS</sub> /ΔT <sub>j</sub>	-	0.7	-	V/°C	Reference to 25°C, I <sub>D</sub> =250μA
V <sub>GS(th)</sub>	2.0	-	4.0	V	V <sub>DS</sub> = V <sub>GS</sub> , I <sub>D</sub> =250μA
*G <sub>FS</sub>	-	13	-	S	V <sub>DS</sub> =15V, I <sub>D</sub> =5A
I <sub>GSS</sub>	-	-	±100	nA	V <sub>GS</sub> =±30V
I <sub>DSS</sub>	-	-	1	μA	V <sub>DS</sub> =700V, V <sub>GS</sub> =0V
	-	-	10		V <sub>DS</sub> =560V, V <sub>GS</sub> =0V, T <sub>j</sub> =125°C
*R <sub>DS(ON)</sub>	-	0.66	0.9	Ω	V <sub>GS</sub> =10V, I <sub>D</sub> =5A
<b>Dynamic</b>					
*Q <sub>g</sub>	-	42	-	nC	I <sub>D</sub> =10A, V <sub>DD</sub> =560V, V <sub>GS</sub> =10V
*Q <sub>gs</sub>	-	9.5	-		
*Q <sub>gd</sub>	-	12.5	-		
*t <sub>d(ON)</sub>	-	21	-	ns	V <sub>DD</sub> =350V, I <sub>D</sub> =10A, V <sub>GS</sub> =10V, R <sub>G</sub> =9.1 Ω
*t <sub>r</sub>	-	10	-		
*t <sub>d(OFF)</sub>	-	65.4	-		
*t <sub>f</sub>	-	12.6	-		
C <sub>iss</sub>	-	2030	-	pF	V <sub>GS</sub> =0V, V <sub>DS</sub> =25V, f=1MHz
C <sub>oss</sub>	-	147	-		
C <sub>rss</sub>	-	25	-		
R <sub>g</sub>	-	1	-	Ω	f=1MHz
<b>Source-Drain Diode</b>					
*V <sub>SD</sub>	-	0.79	1.5	V	I <sub>S</sub> =5A, V <sub>GS</sub> =0V
*I <sub>S</sub>	-	-	10	A	
*I <sub>SM</sub>	-	-	40		
*t <sub>rr</sub>	-	450	-	ns	V <sub>GS</sub> =0V, I <sub>F</sub> =10A, dI <sub>F</sub> /dt=100A/μs
*Q <sub>rr</sub>	-	4.1	-	μC	

\*Pulse Test : Pulse Width ≤300μs, Duty Cycle≤2%

## Typical Characteristics

Typical Output Characteristics

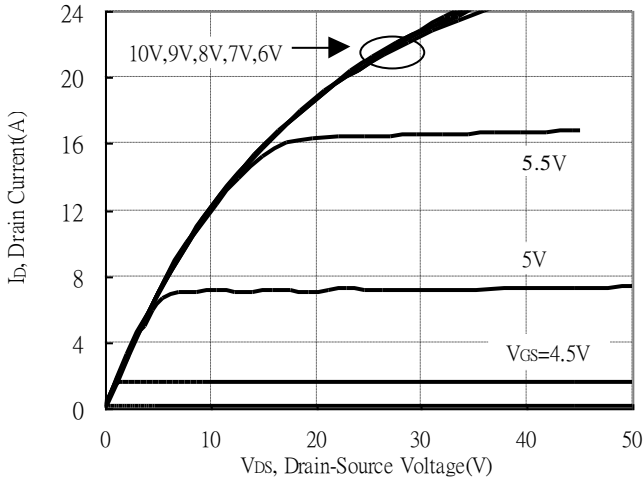

Static Drain-Source On-resistance vs Ambient Temperature

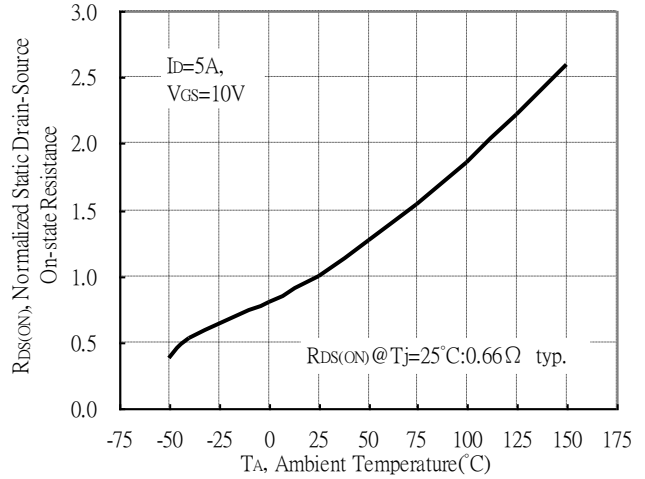

Static Drain-Source On-State resistance vs Drain Current

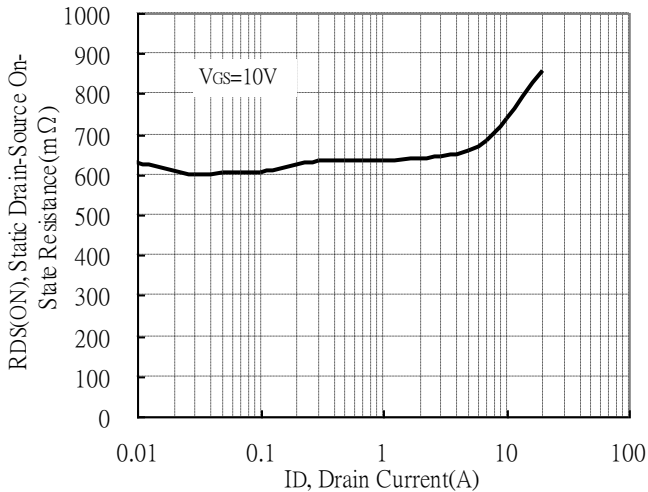

Drain Current vs Gate-Source Voltage

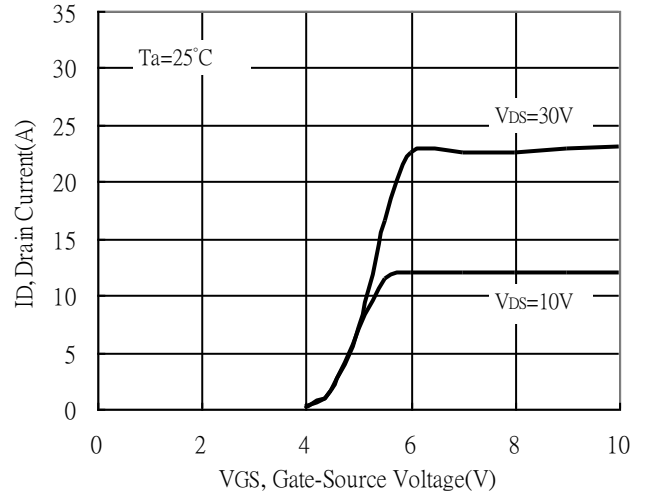

Static Drain-Source On-State Resistance vs Gate-Source Voltage

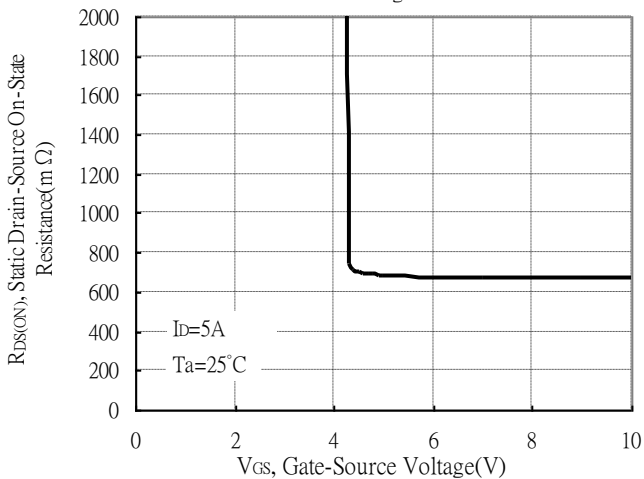

Forward Drain Current vs Source-Drain Voltage

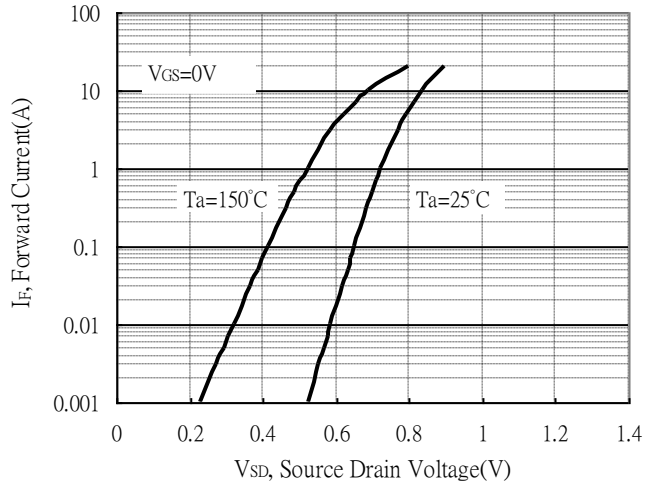

**Typical Characteristics(Cont.)**

Capacitance vs Reverse Voltage

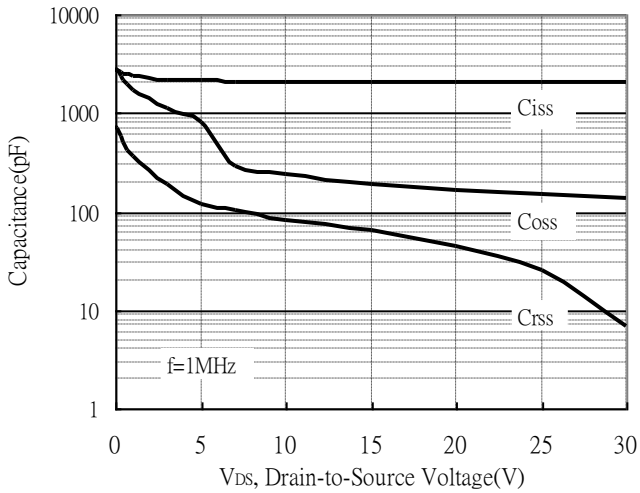

Brekdown Voltage vs Ambient Temperature

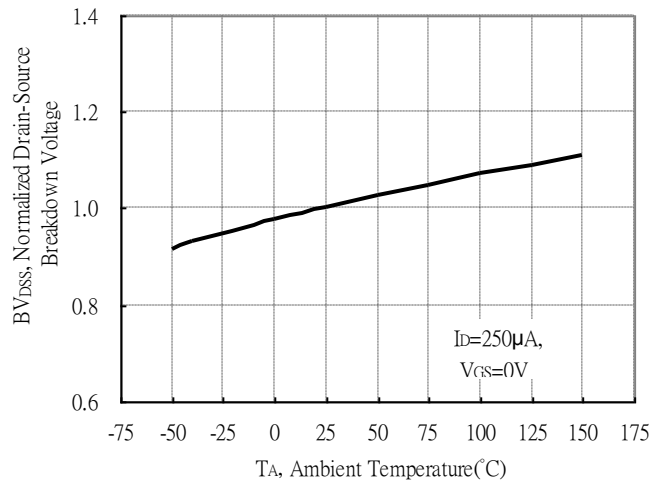

Maximum Safe Operating Area

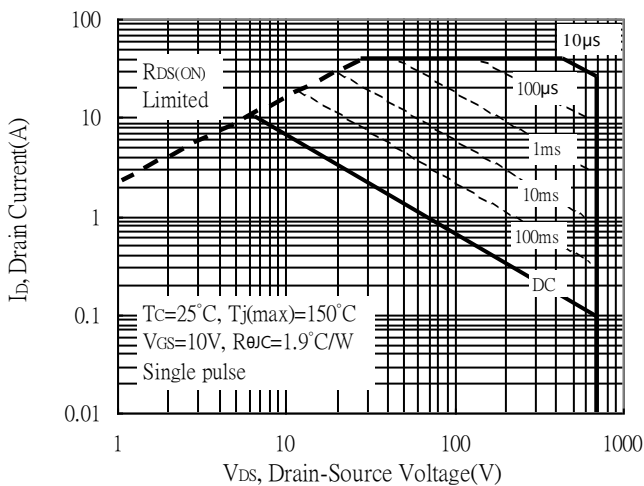

Gate Charge Characteristics

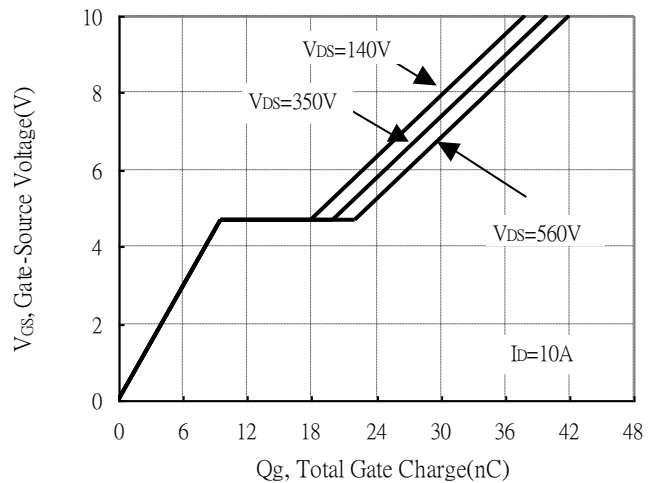

Maximum Drain Current vs Case Temperature

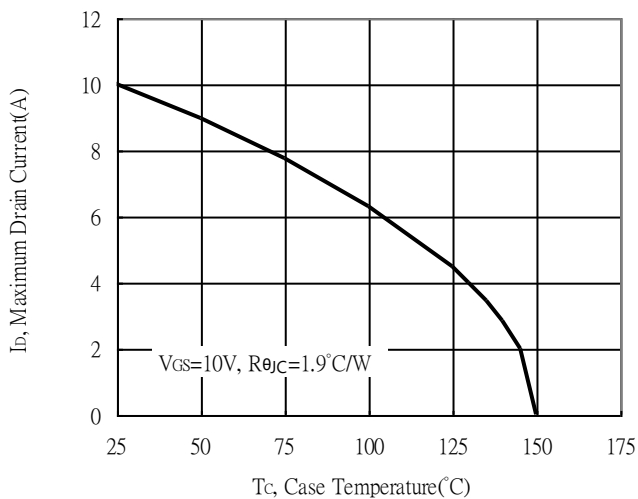

Threshold Voltage vs Junction Temperature

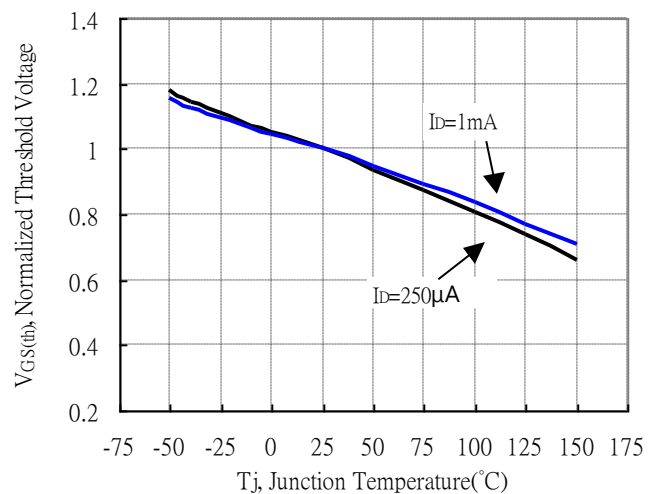

**Typical Characteristics(Cont.)**

Single Pulse Power Rating, Junction to Case

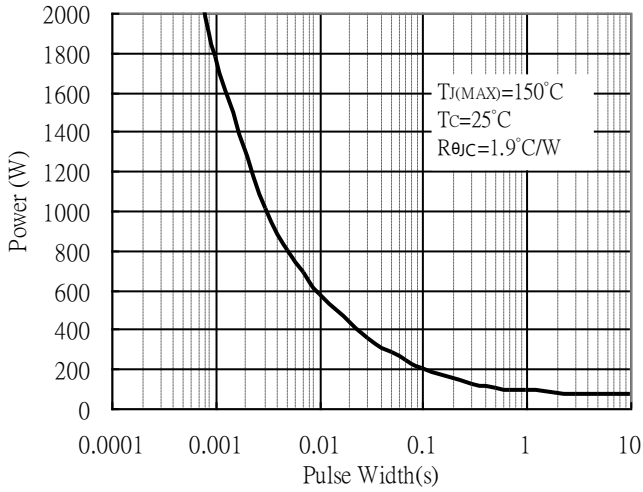

Forward Transfer Admittance vs Drain Current

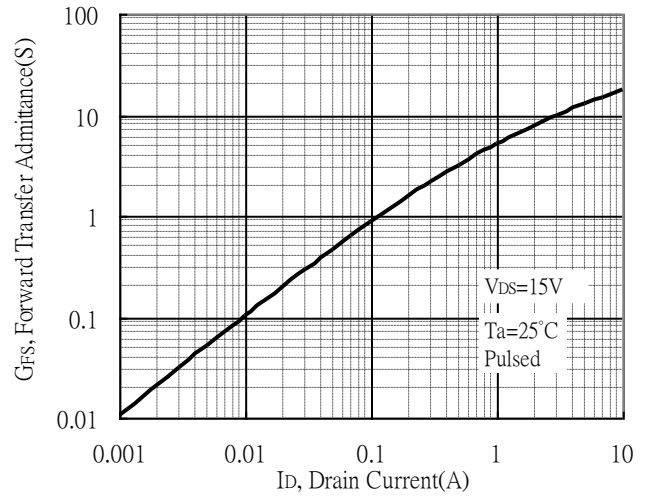

Transient Thermal Response Curves

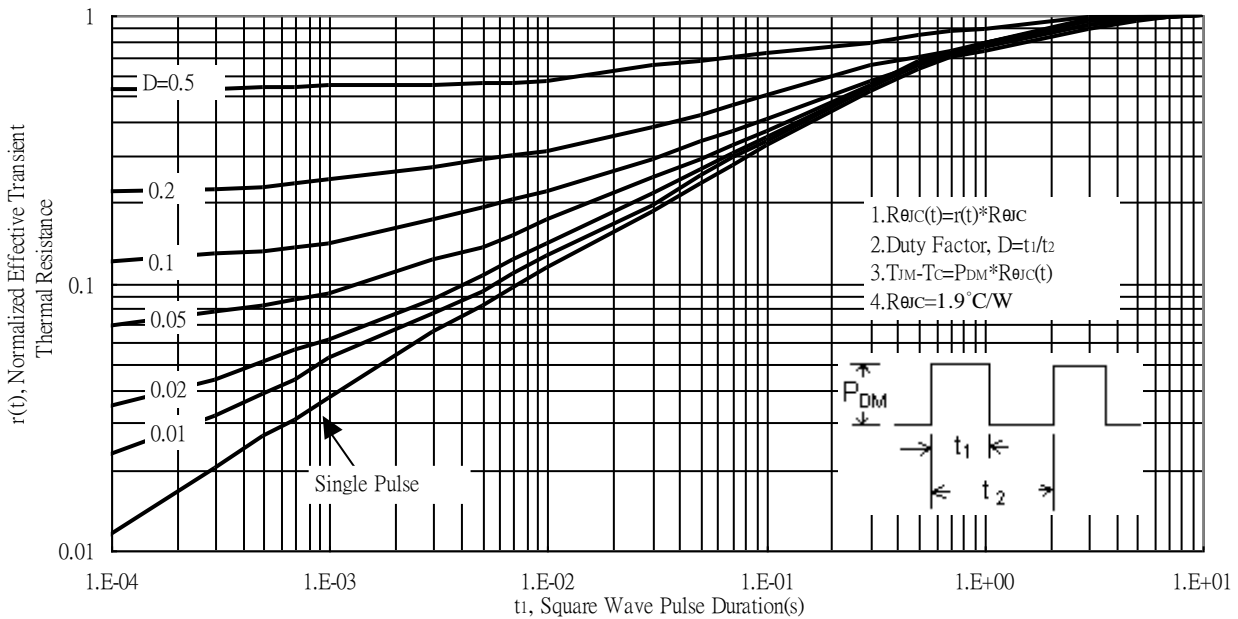

**Test Circuits and Waveforms**



**Gate Charge Test Circuit**

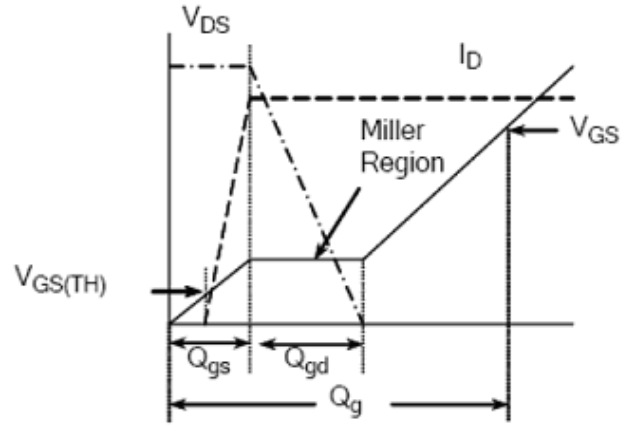

**Gate Charge Waveform**



**Resistive Switching Test Circuit**



**Resistive Switching Waveforms**

**Test Circuits and Waveforms(Cont.)**

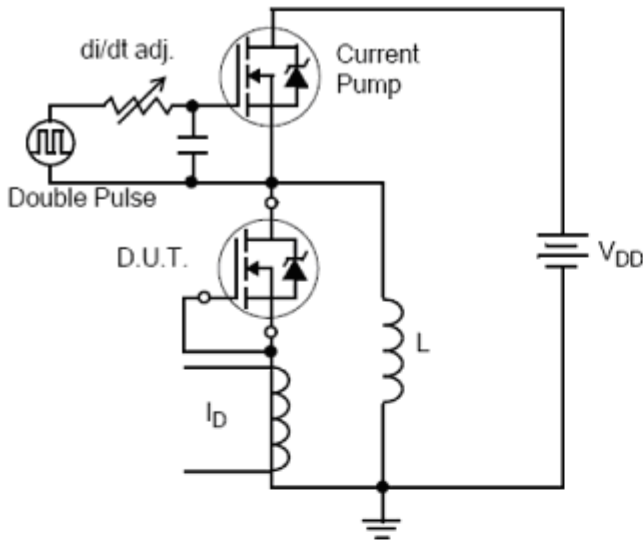

**Diode Reverse Recovery Test Circuit**

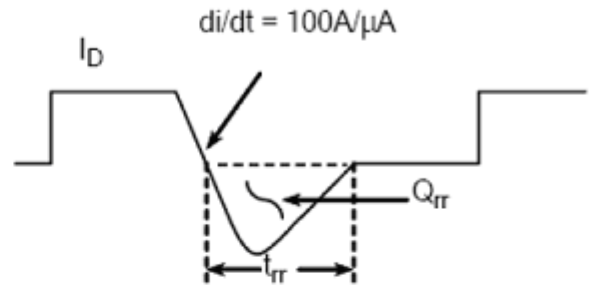

**Diode Reverse Recovery Waveform**

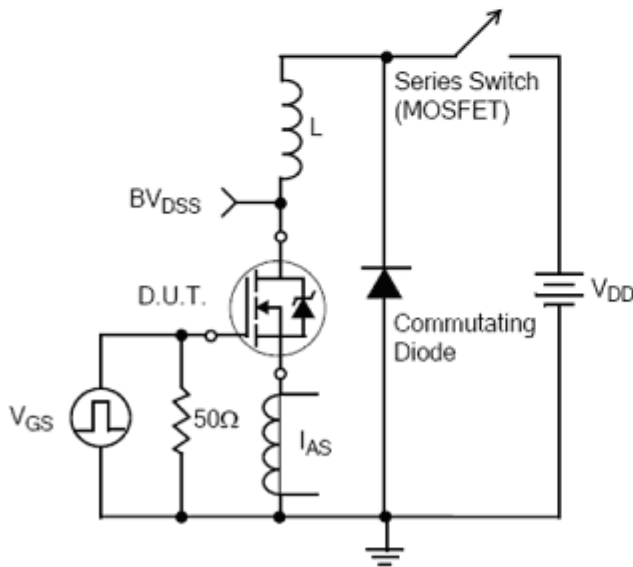

**Unclamped Inductive Switching Test Circuit**

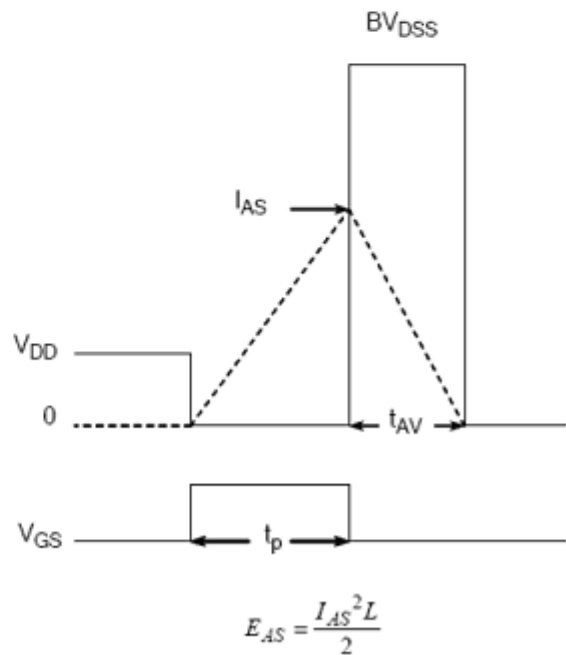

**Unclamped Inductive Switching Waveforms**



**Recommended wave soldering condition**

Product	Peak Temperature	Soldering Time
Pb-free devices	260 +0/-5 °C	5 +1/-1 seconds

**Recommended temperature profile for IR reflow**

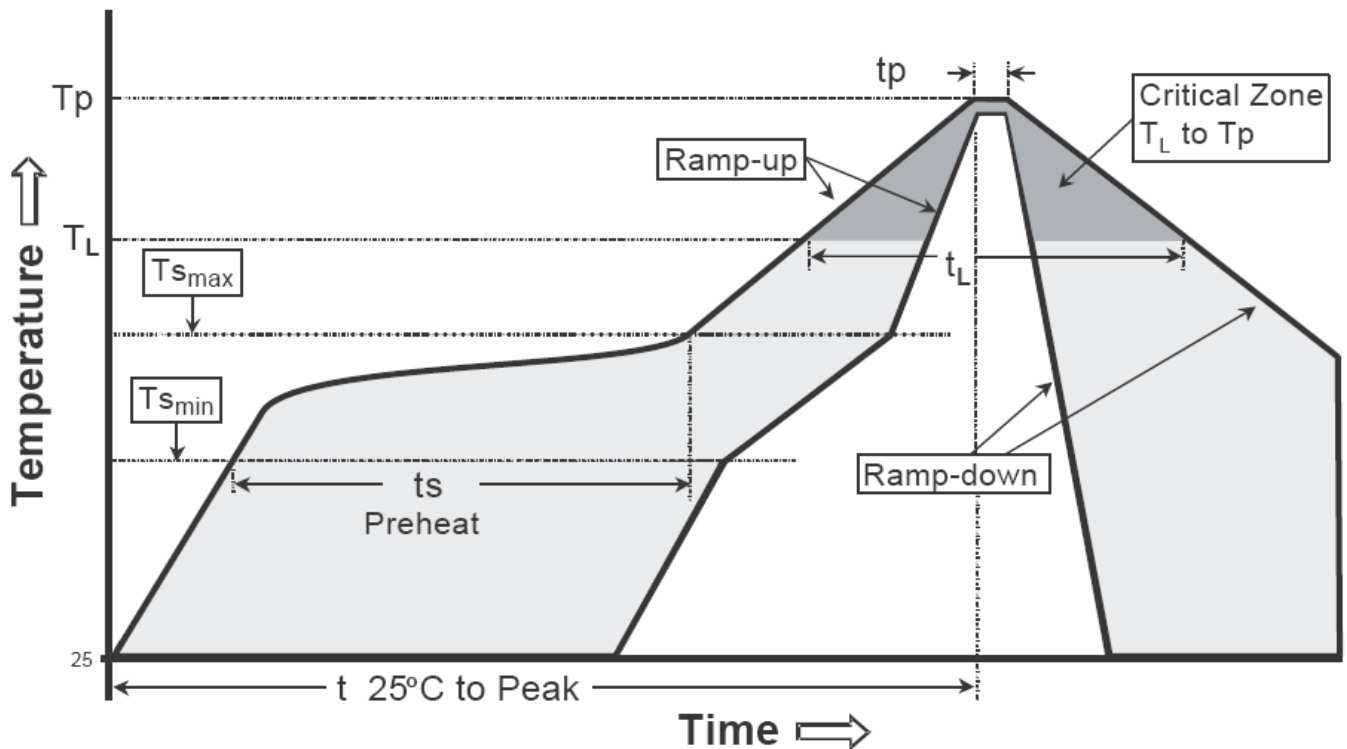

Profile feature	Sn-Pb eutectic Assembly	Pb-free Assembly
Average ramp-up rate (Tsmax to Tp)	3°C/second max.	3°C/second max.
Preheat		
-Temperature Min(Ts min)	100°C	150°C
-Temperature Max(Ts max)	150°C	200°C
-Time(ts min to ts max)	60-120 seconds	60-180 seconds
Time maintained above:		
-Temperature (Tl)	183°C	217°C
- Time (tl)	60-150 seconds	60-150 seconds
Peak Temperature(Tp)	240 +0/-5 °C	260 +0/-5 °C
Time within 5°C of actual peak temperature(tp)	10-30 seconds	20-40 seconds
Ramp down rate	6°C/second max.	6°C/second max.
Time 25 °C to peak temperature	6 minutes max.	8 minutes max.

Note : All temperatures refer to topside of the package, measured on the package body surface.

## TO-220FP Dimension

3-Lead TO-220FP Plastic Package  
 CYStek Package Code: FP

Marking:  
 Device Name → CYS 10N70  
 Date Code → □□□□

Style: Pin 1.Gate 2.Drain 3.Source

\*Typical

DIM	Inches		Millimeters		DIM	Inches		Millimeters	
	Min.	Max.	Min.	Max.		Min.	Max.	Min.	Max.
A	0.171	0.183	4.35	4.65	G	0.246	0.258	6.25	6.55
A1	0.051 REF		1.300 REF		H	0.138 REF		3.50 REF	
A2	0.112	0.124	2.85	3.15	H1	0.055 REF		1.40 REF	
A3	0.102	0.110	2.60	2.80	H2	0.256	0.272	6.50	6.90
b	0.020	0.030	0.50	0.75	J	0.031 REF		0.80 REF	
b1	0.031	0.041	0.80	1.05	K	0.020		0.50 REF	
b2	0.047 REF		1.20 REF		L	1.102	1.118	28.00	28.40
c	0.020	0.030	0.500	0.750	L1	0.043	0.051	1.10	1.30
D	0.396	0.404	10.06	10.26	L2	0.036	0.043	0.92	1.08
E	0.583	0.598	14.80	15.20	M	0.067 REF		1.70 REF	
e	0.100 *		2.54*		N	0.012 REF		0.30 REF	
F	0.106 REF		2.70 REF						

- Notes: 1.Controlling dimension: millimeters.  
 2.Maximum lead thickness includes lead finish thickness, and minimum lead thickness is the minimum thickness of base material.  
 3.If there is any question with packing specification or packing method, please contact your local CYStek sales office.

**Material:**

- Lead: Pure tin plated.
- Mold Compound: Epoxy resin family, flammability solid burning class: UL94V-0.

**Important Notice:**

- All rights are reserved. Reproduction in whole or in part is prohibited without the prior written approval of CYStek.
- CYStek reserves the right to make changes to its products without notice.
- CYStek **semiconductor products are not warranted to be suitable for use in Life-Support Applications, or systems.**
- CYStek assumes no liability for any consequence of customer product design, infringement of patents, or application assistance.