

N-Channel Enhancement Mode Power MOSFET

MTEB4N15J3

Features

- Low Gate Charge
- Fast Switching Characteristic

| | |
|--|-------|
| BV_{DSS} | 150V |
| $I_D@V_{GS}=10V, T_C=25^\circ C$ | 6A |
| $I_D@V_{GS}=10V, T_A=25^\circ C$ | 2A |
| $R_{DS(ON) typ. @ V_{GS}=10V, I_D=2A}$ | 250mΩ |

Equivalent Circuit

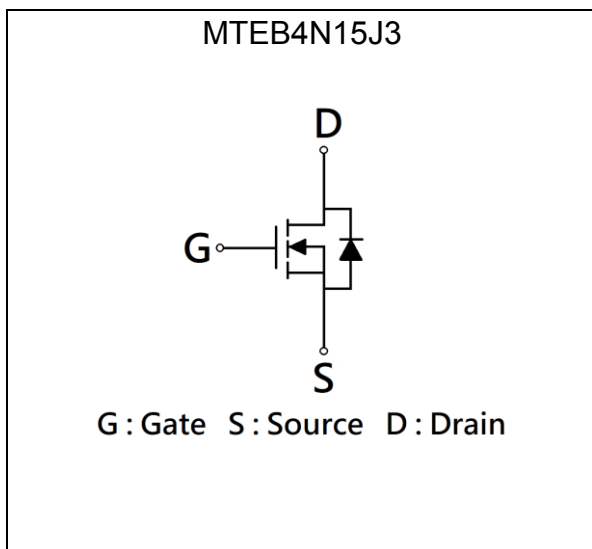

Outline

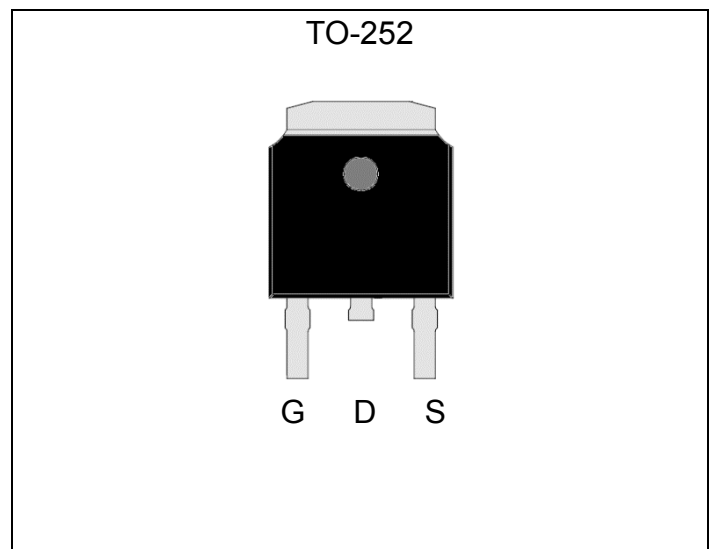

Ordering Information

| Device | Package | Shipping |
|-------------------|---|------------------------|
| MTEB4N15J3-0-T3-G | TO-252 (Pb-free lead plating and halogen-free package) | 2500 pcs / tape & reel |

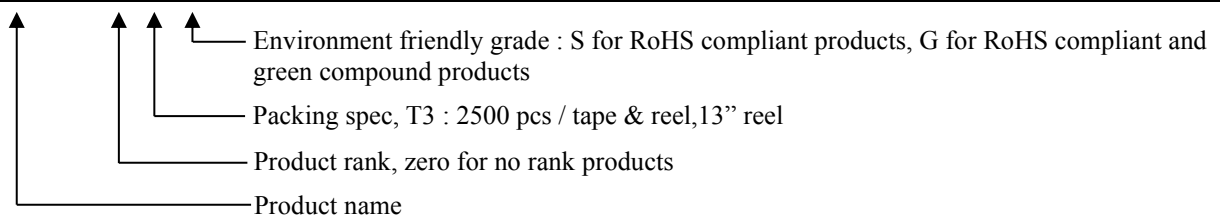

**Absolute Maximum Ratings (T_A=25°C)**

| Parameter | Symbol | Limits | Unit | |
|--|-----------------|-----------------------------------|----------|----|
| Drain-Source Voltage | V _{DS} | 150 | V | |
| Gate-Source Voltage | V _{GS} | ±20 | | |
| Continuous Drain Current @ V _{GS} =10V, T _C =25°C | I _D | 6 | A | |
| Continuous Drain Current @ V _{GS} =10V, T _C =100°C | | 3.8 | | |
| Continuous Drain Current @ V _{GS} =10V, T _A =25°C | | 2 | | |
| Continuous Drain Current @ V _{GS} =10V, T _A =70°C | | 1.6 | | |
| Pulsed Drain Current | I _{DM} | 12 | | |
| Continuous Body Diode Forward Current @ T _C =25°C | I _S | 6 | | |
| Pulsed Body Diode Forward Current @ T _C =25°C | I _{SM} | 12 | | |
| Avalanche Current @ L=0.1mH | I _{AS} | 3 | | |
| Avalanche Energy @ L=0.5mH | E _{AS} | 2.3 | mJ | |
| Total Power Dissipation | P _D | T _C =25°C | 24 | W |
| | | T _C =100°C | 9.6 | |
| | | T _A =25°C | 2.6 | |
| | | T _A =70°C | 1.7 | |
| Operating Junction and Storage Temperature Range | | T _J , T _{stg} | -55~+150 | °C |

Thermal Data

| Parameter | Symbol | Steady State | Unit |
|---|------------------|--------------|------|
| Thermal Resistance, Junction-to-case | R _{θJC} | 5.2 | °C/W |
| Thermal Resistance, Junction-to-ambient | R _{θJA} | 48 | |

Note:

- *a. The power dissipation P_D is based on T_{J(MAX)}=150°C, using junction-to-case thermal resistance, and is more useful in setting the upper dissipation limit for cases where additional heatsinking is used.
- *b. The value of R_{θJA} is measured with the device mounted on 1 in² FR-4 board with 2 oz. copper, in a still air environment with T_A=25°C. The power dissipation P_D is based on R_{θJA} and the maximum allowed junction temperature of 150°C. The value in any given application depends on the user's specific board design.
- *c. Repetitive rating, pulse width limited by junction temperature T_{J(MAX)}=150°C. Ratings are based on low frequency and low duty cycles to keep initial T_J=25°C.



Electrical Characteristics (T_A=25°C, unless otherwise specified)

| Symbol | Min. | Typ. | Max. | Unit | Test Conditions |
|---------------------------|------|------|------|------|---|
| Static | | | | | |
| BV _{DSS} | 150 | - | - | V | V _{GS} =0V, I _D =250μA |
| V _{GS(th)} | 2 | - | 4 | | V _{DS} =V _{GS} , I _D =250μA |
| G _{FS} | - | 2.5 | - | S | V _{DS} =10V, I _D =2A |
| I _{GSS} | - | - | ±100 | nA | V _{GS} =±20V, V _{DS} =0V |
| I _{DSS} | - | - | 1 | μA | V _{DS} =120V, V _{GS} =0V |
| R _{DS(ON)} | - | 250 | 330 | mΩ | V _{GS} =10V, I _D =2A |
| Dynamic | | | | | |
| C _{iSS} | - | 240 | - | pF | V _{DS} =75V, V _{GS} =0V, f=1MHz |
| C _{oSS} | - | 25 | - | | |
| C _{rSS} | - | 20 | - | | |
| R _g | - | 2 | - | Ω | f=1MHz |
| Q _g *1, 2 | - | 6 | - | nC | V _{DS} =75V, I _D =2A, V _{GS} =10V |
| Q _{gs} *1, 2 | - | 1.5 | - | | |
| Q _{gd} *1, 2 | - | 1.6 | - | | |
| t _{d(ON)} *1, 2 | - | 6 | - | ns | V _{DS} =75V, I _D =2A, V _{GS} =10V, R _{GS} =6Ω |
| t _r *1, 2 | - | 16 | - | | |
| t _{d(OFF)} *1, 2 | - | 13 | - | | |
| t _f *1, 2 | - | 14 | - | | |
| Source-Drain Diode | | | | | |
| V _{SD} *1 | - | 0.85 | 1.2 | V | I _S =2A, V _{GS} =0V |
| t _{rr} | - | 37 | - | ns | I _F =2A, dI _F /dt=100A/μs |
| Q _{rr} | - | 52 | - | nC | |

Note:

*1. Pulse Test : Pulse Width ≤300μs, Duty Cycle≤2%

*2. Independent of operating temperature



Typical Characteristics

Typical Output Characteristics

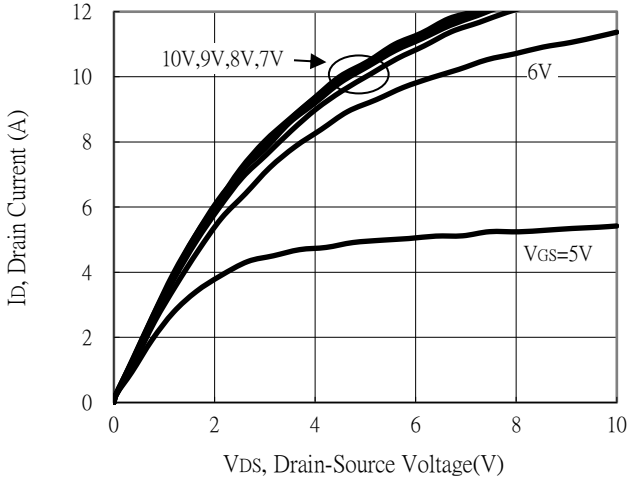

Breakdown Voltage vs Ambient Temperature

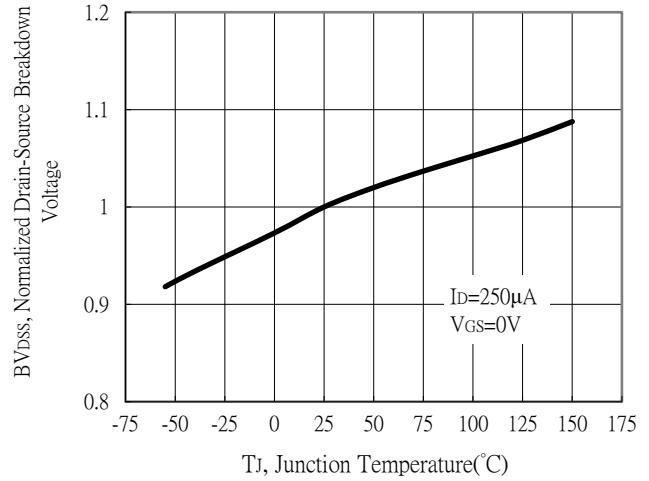

Static Drain-Source On-State resistance vs Drain Current

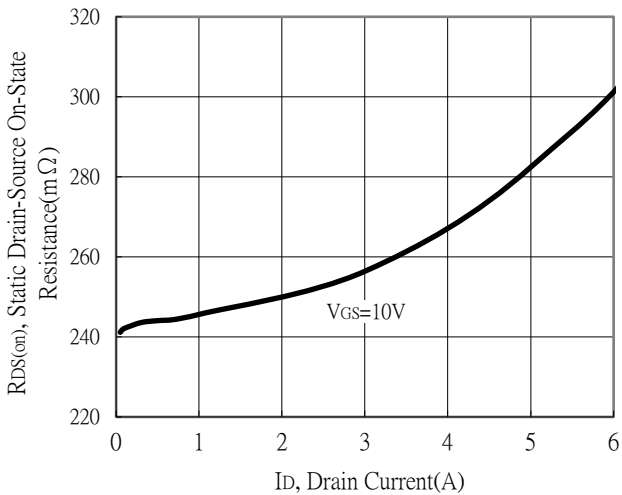

Body Diode Current vs Source-Drain Voltage

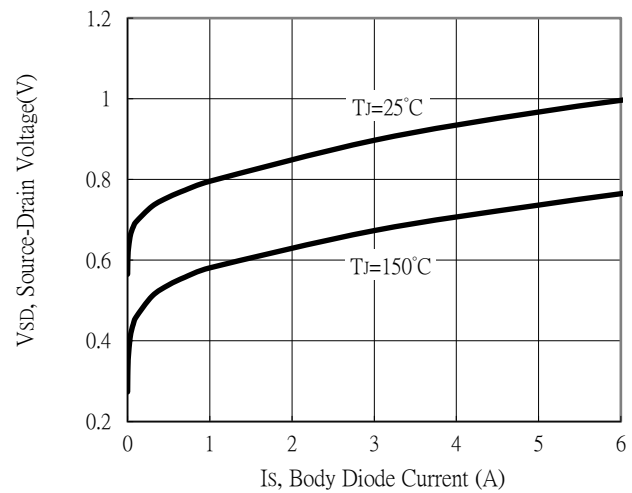

Static Drain-Source On-State Resistance vs Gate-Source Voltage

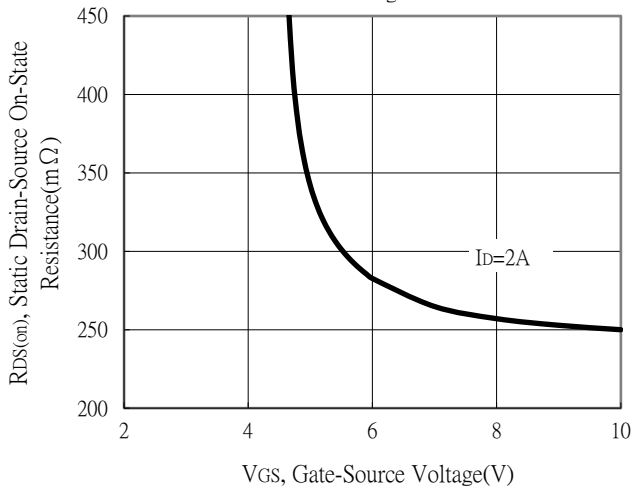

Drain-Source On-State Resistance vs Junction Temperature

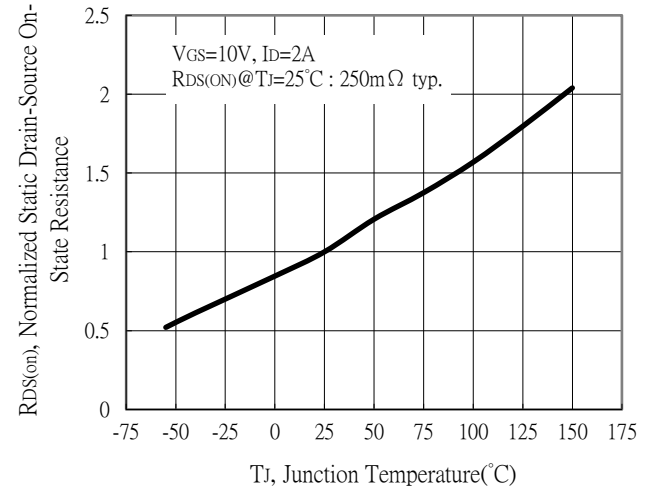



Typical Characteristics (Cont.)

Capacitance vs Drain-to-Source Voltage

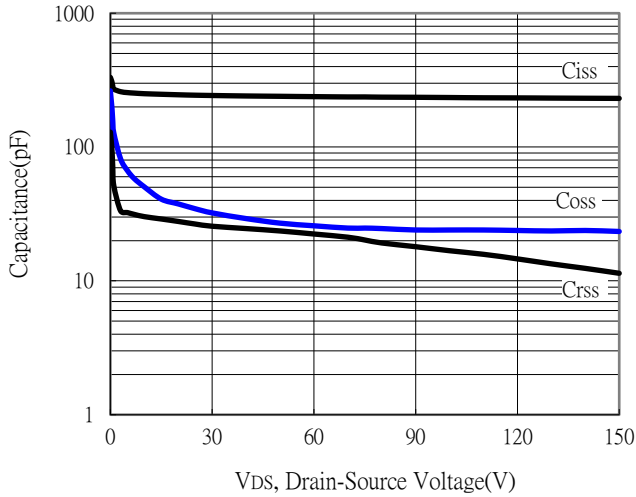

Threshold Voltage vs Junction Temperature

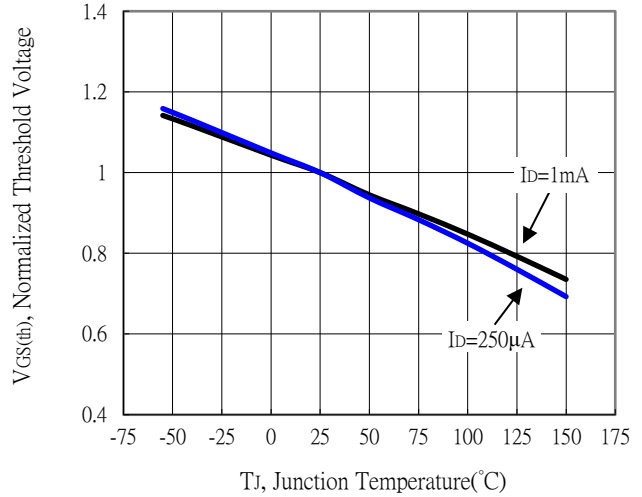

Forward Transfer Admittance vs Drain Current

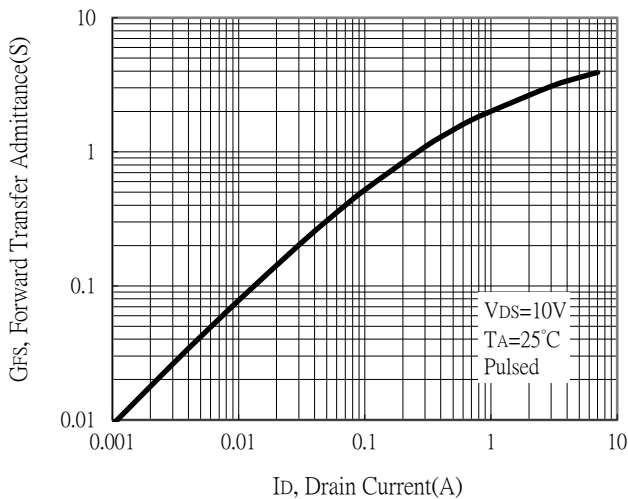

Gate Charge Characteristics

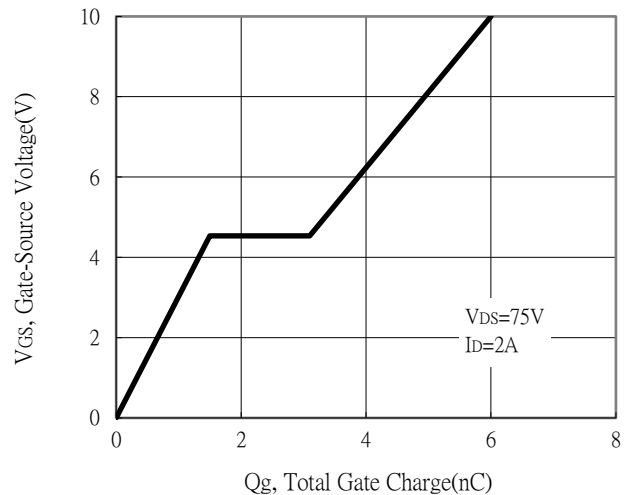

Maximum Safe Operating Area

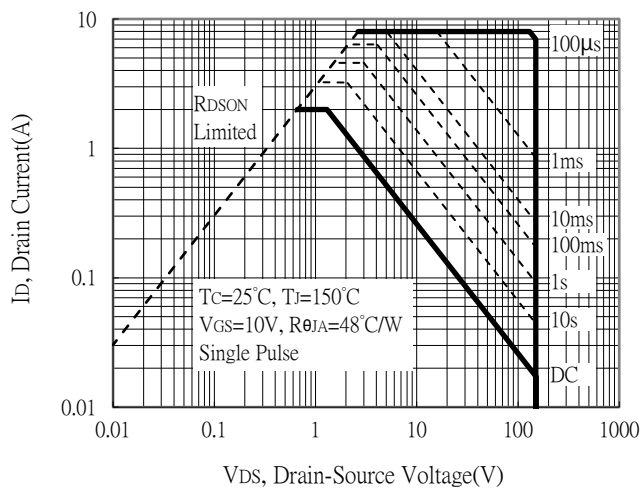

Maximum Drain Current vs Junction Temperature

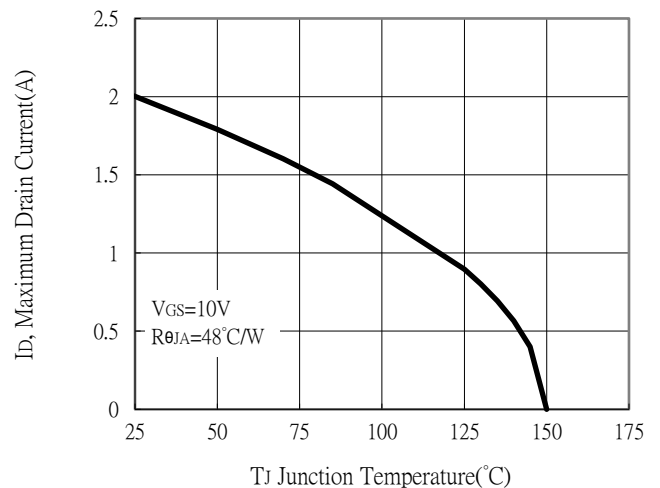

Typical Characteristics (Cont.)

Single Pulse Power Rating, Junction to Ambient

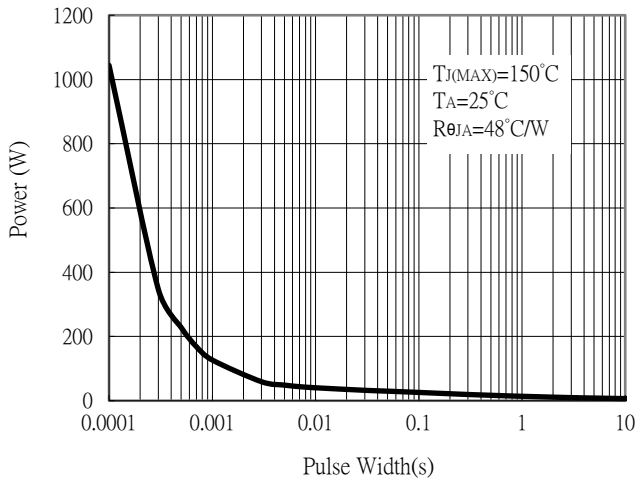

Transient Thermal Response Curves

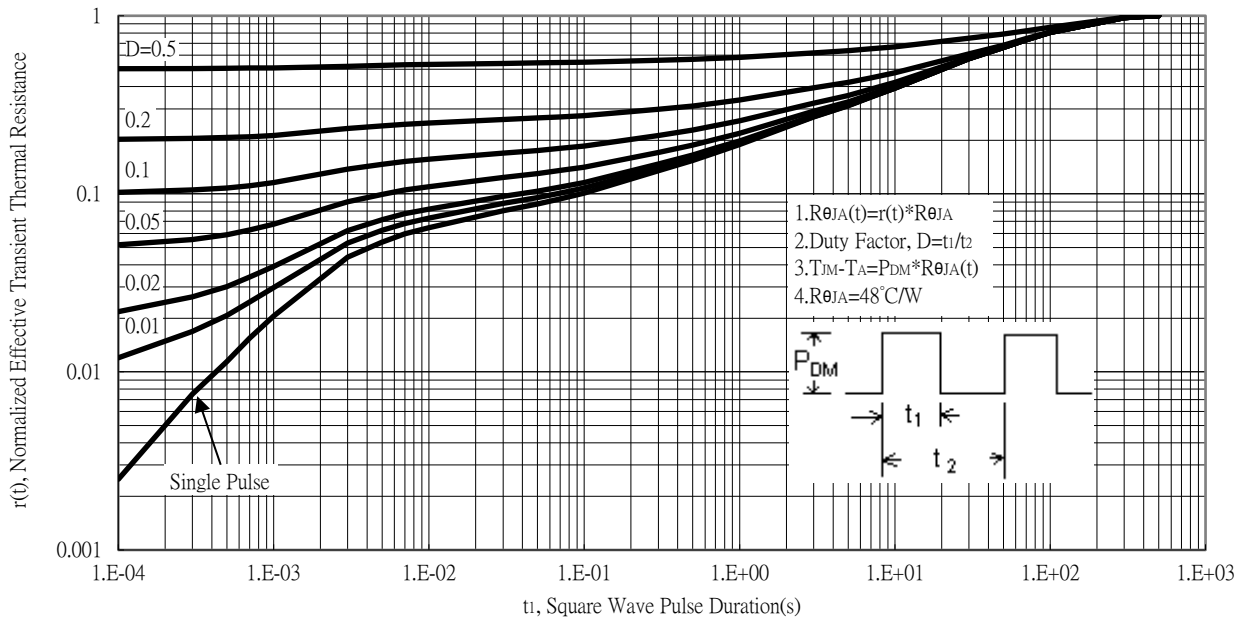

Recommended soldering footprint

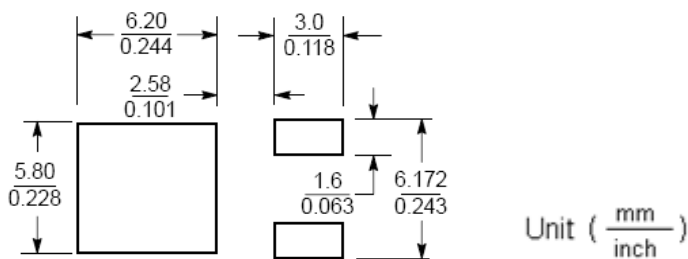

Reel Dimension

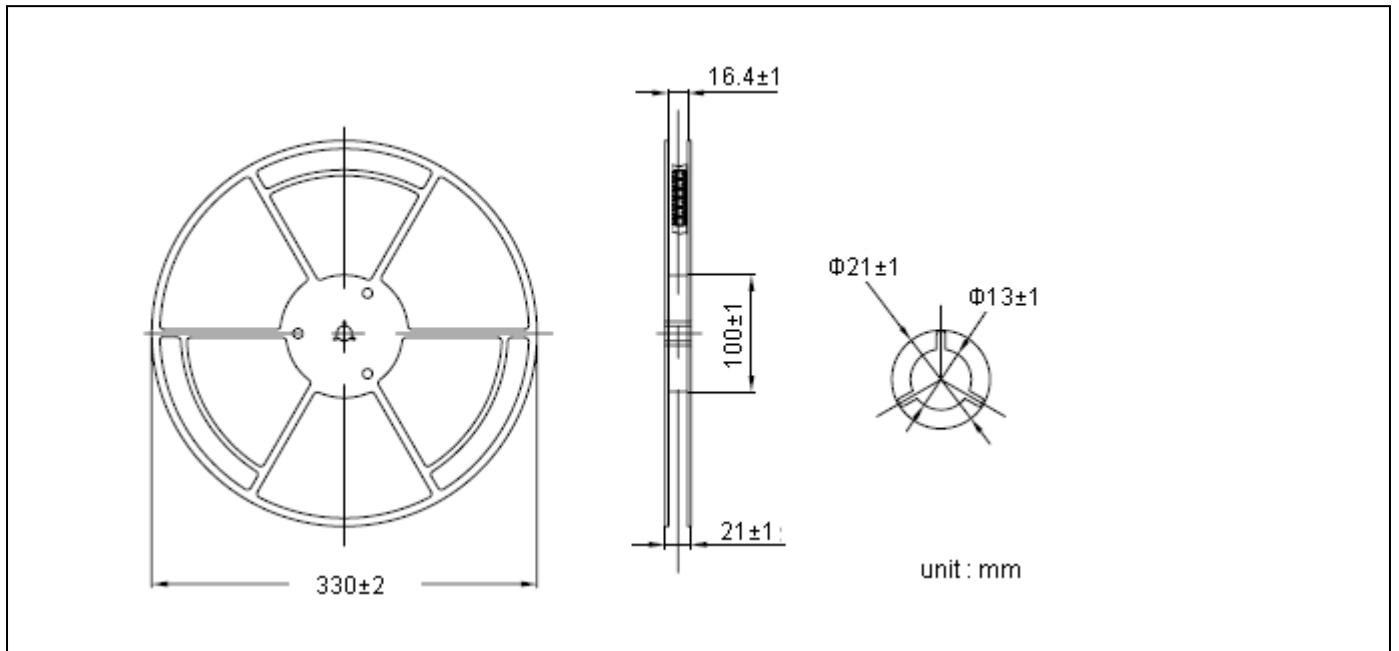

Carrier Tape Dimension

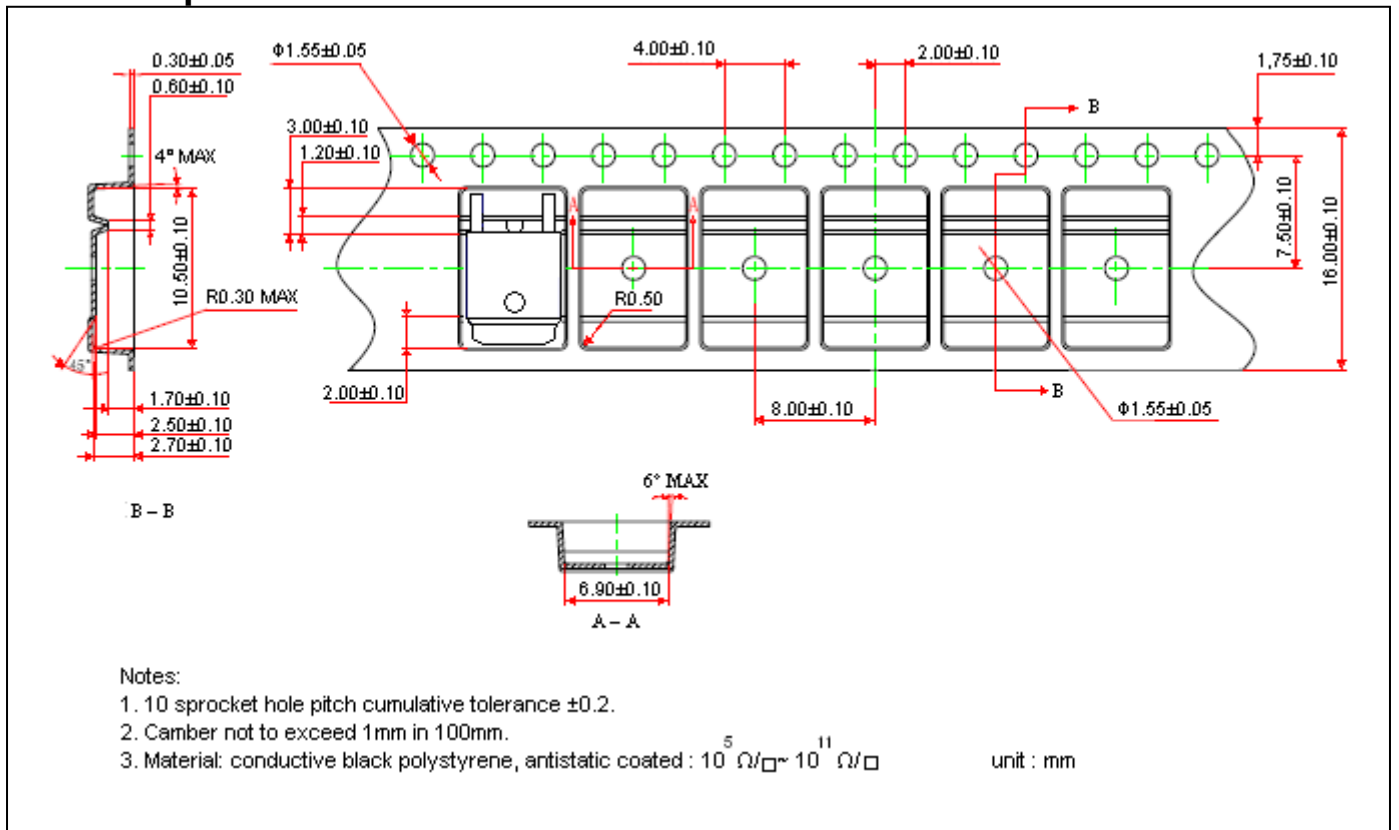

Recommended wave soldering condition

| | | |
|-----------------|------------------|-----------------|
| Product | Peak Temperature | Soldering Time |
| Pb-free devices | 260 +0/-5 °C | 5 +1/-1 seconds |

Recommended temperature profile for IR reflow

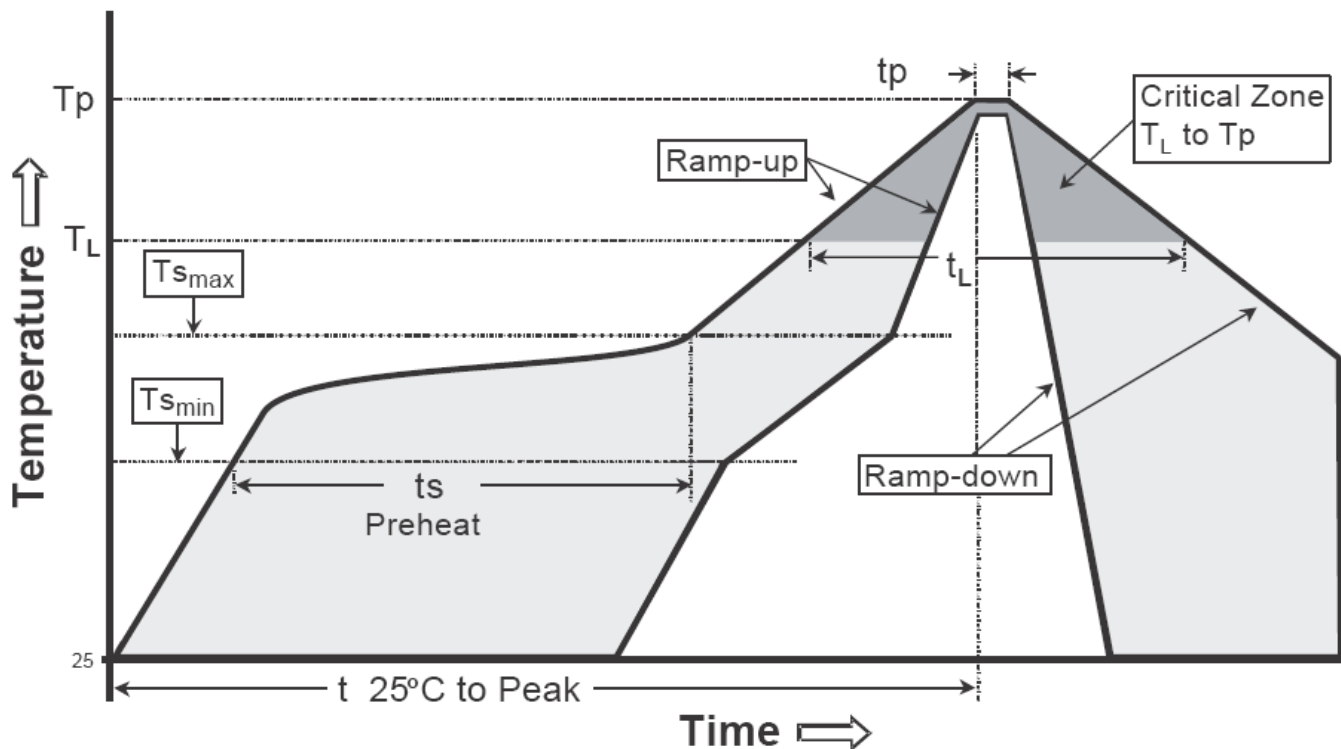

| Profile feature | Sn-Pb eutectic Assembly | Pb-free Assembly |
|---|-------------------------|------------------|
| Average ramp-up rate (T _{smax} to T _p) | 3°C/second max. | 3°C/second max. |
| Preheat | | |
| -Temperature Min(T _{s min}) | 100°C | 150°C |
| -Temperature Max(T _{s max}) | 150°C | 200°C |
| -Time(t _{s min} to t _{s max}) | 60-120 seconds | 60-180 seconds |
| Time maintained above: | | |
| -Temperature (T _L) | 183°C | 217°C |
| - Time (t _L) | 60-150 seconds | 60-150 seconds |
| Peak Temperature(T _P) | 240 +0/-5 °C | 260 +0/-5 °C |
| Time within 5°C of actual peak temperature(tp) | 10-30 seconds | 20-40 seconds |
| Ramp down rate | 6°C/second max. | 6°C/second max. |
| Time 25 °C to peak temperature | 6 minutes max. | 8 minutes max. |

Note : All temperatures refer to topside of the package, measured on the package body surface.

TO-252 Dimension

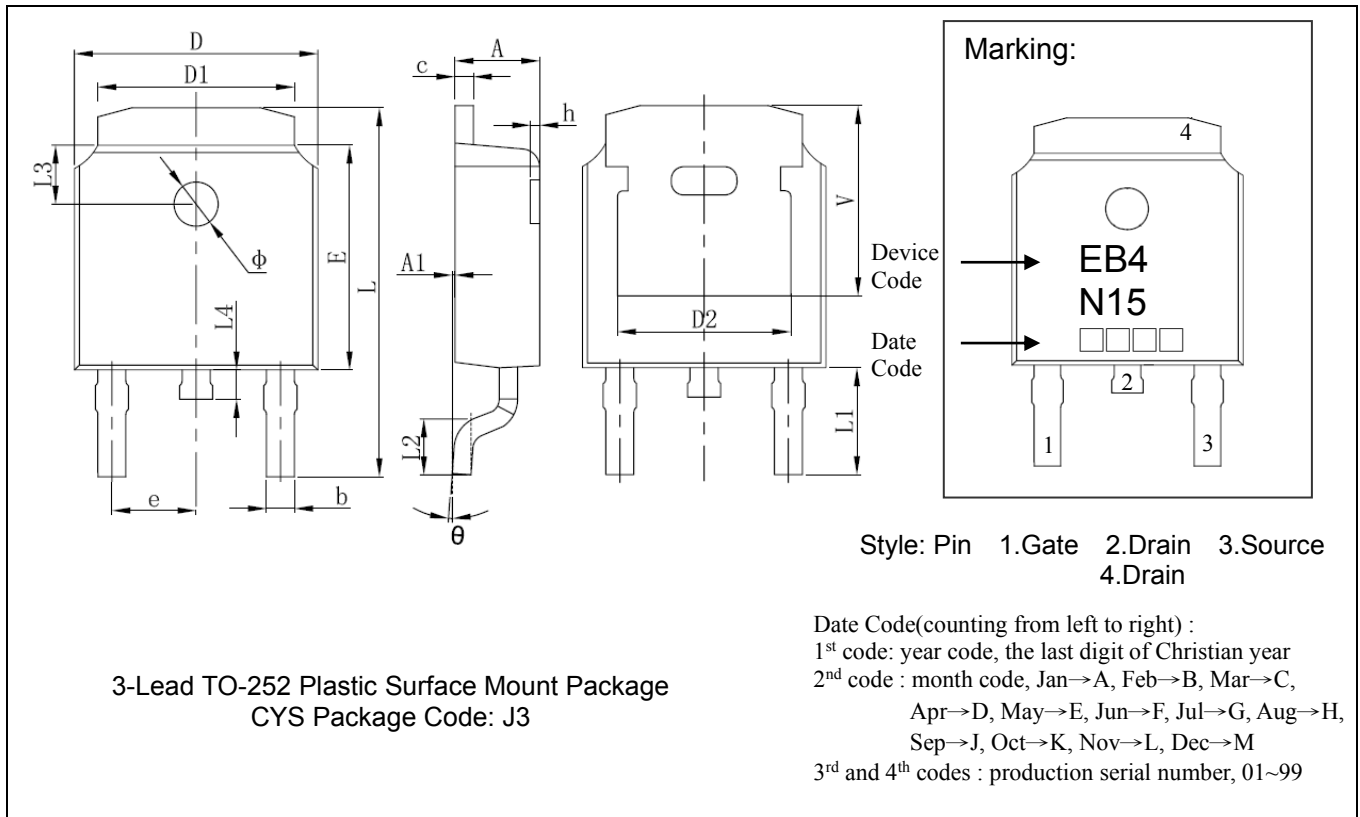

3-Lead TO-252 Plastic Surface Mount Package
 CYS Package Code: J3

Style: Pin 1.Gate 2.Drain 3.Source 4.Drain

Date Code(counting from left to right) :
 1st code: year code, the last digit of Christian year
 2nd code : month code, Jan→A, Feb→B, Mar→C, Apr→D, May→E, Jun→F, Jul→G, Aug→H, Sep→J, Oct→K, Nov→L, Dec→M
 3rd and 4th codes : production serial number, 01~99

| DIM | Inches | | Millimeters | | DIM | Inches | | Millimeters | |
|-----|--------|-------|-------------|-------|-----|--------|-------|-------------|--------|
| | Min. | Max. | Min. | Max. | | Min. | Max. | Min. | Max. |
| A | 0.087 | 0.094 | 2.200 | 2.400 | L | 0.382 | 0.406 | 9.712 | 10.312 |
| A1 | 0.000 | 0.005 | 0.000 | 0.127 | L1 | 0.114 | REF | 2.900 | REF |
| b | 0.025 | 0.030 | 0.635 | 0.770 | L2 | 0.055 | 0.067 | 1.400 | 1.700 |
| c | 0.018 | 0.023 | 0.460 | 0.580 | L3 | 0.063 | REF | 1.600 | REF |
| D | 0.256 | 0.264 | 6.500 | 6.700 | L4 | 0.024 | 0.039 | 0.600 | 1.000 |
| D1 | 0.201 | 0.215 | 5.100 | 5.460 | Φ | 0.043 | 0.051 | 1.100 | 1.300 |
| D2 | 0.190 | REF | 4.830 | REF | θ | 0° | 8° | 0° | 8° |
| E | 0.236 | 0.244 | 6.000 | 6.200 | h | 0.000 | 0.012 | 0.000 | 0.300 |
| e | 0.086 | 0.094 | 2.186 | 2.386 | V | 0.207 | REF | 5.250 | REF |

Notes: 1.Controlling dimension: millimeters.
 2.Maximum lead thickness includes lead finish thickness, and minimum lead thickness is the minimum thickness of base material.
 3.If there is any question with packing specification or packing method, please contact your local CYStek sales office.

Material:

- Lead : Pure tin plated.
- Mold Compound: Epoxy resin family, flammability solid burning class: UL94V-0.

Important Notice:

- All rights are reserved. Reproduction in whole or in part is prohibited without the prior written approval of CYStek.
- CYStek reserves the right to make changes to its products without notice.
- CYStek **semiconductor products are not warranted to be suitable for use in Life-Support Applications, or systems.**
- CYStek assumes no liability for any consequence of customer product design, infringement of patents, or application assistance.