

N-Channel Enhancement Mode Power MOSFET

MTE130N20FP

| | |
|-----------------------------------------------------------------|---------------------|
| BV_{DSS} | 200V |
| I_D @ V_{GS}=10V | 17A |
| R_{DS(ON)}@ V_{GS}=10V, I_D=9A | 150 mΩ (typ) |

Features

- Simple Drive Requirement
- Low Gate Charge
- Fast Switching Characteristic
- Insulating package, front/back side insulating voltage=2500V(AC)
- RoHS compliant package

Symbol

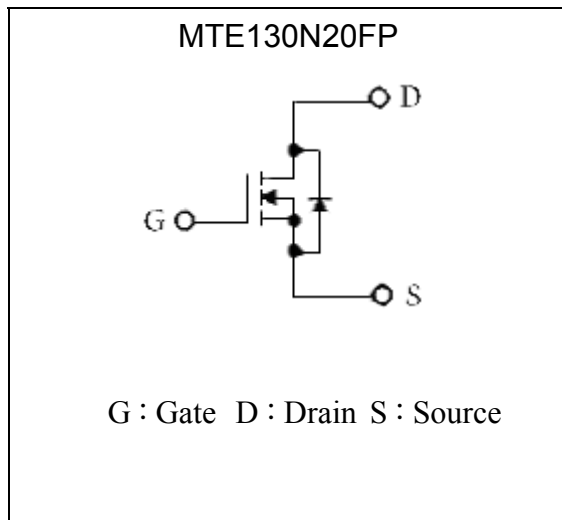

Outline

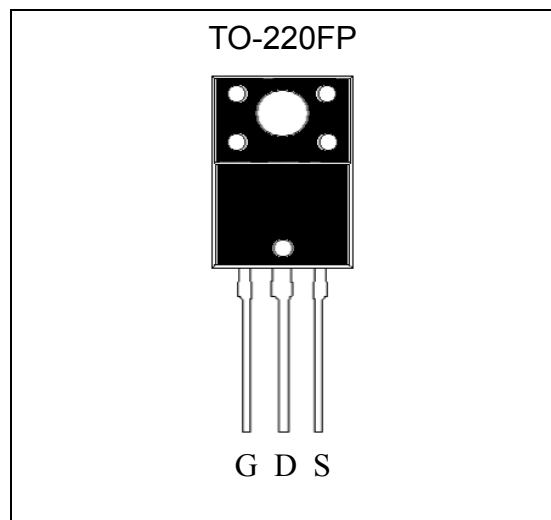

Ordering Information

| Device | Package | Shipping |
|--------------------|--------------------------------------|---------------------------------------------|
| MTE130N20FP-0-UB-S | TO-220FP (RoHS compliant package) | 50 pcs/tube, 20 tubes/box, 4 boxes / carton |

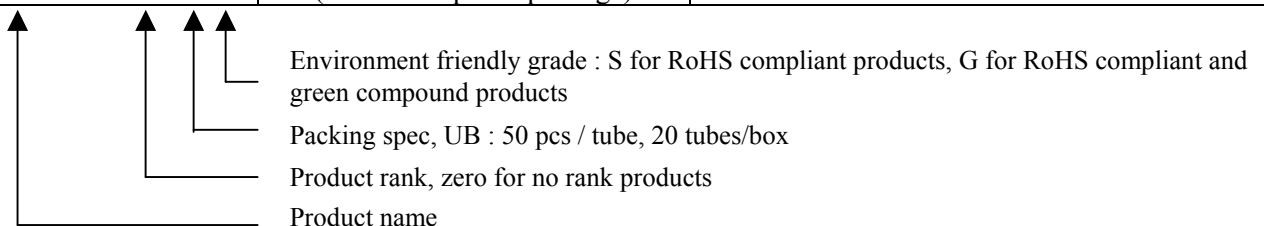

**Absolute Maximum Ratings** ($T_C=25^{\circ}\text{C}$)

| Parameter | Symbol | Limits | Unit | |
|---------------------------------------------------------------------------------------------------------|----------------|------------------------------------|--------------------|---|
| Drain-Source Voltage (Note 1) | V_{DS} | 200 | V | |
| Gate-Source Voltage | V_{GS} | ± 20 | | |
| Continuous Drain Current @ $T_C=25^{\circ}\text{C}$, $V_{GS}=10\text{V}$ (Note 1) | I_D | 17* | A | |
| Continuous Drain Current @ $T_C=100^{\circ}\text{C}$, $V_{GS}=10\text{V}$ (Note 1) | | 12* | | |
| Continuous Drain Current @ $T_A=25^{\circ}\text{C}$, $V_{GS}=10\text{V}$ (Note 2) | I_{DSM} | 3.4 | | |
| Continuous Drain Current @ $T_A=70^{\circ}\text{C}$, $V_{GS}=10\text{V}$ (Note 2) | | 2.7 | | |
| Pulsed Drain Current @ $V_{GS}=10\text{V}$ (Note 3) | I_{DM} | 34* | | |
| Avalanche Current (Note 3) | I_{AS} | 3.5 | | |
| Single Pulse Avalanche Energy @ $L=1\text{mH}$, $I_D=3.5\text{Amps}$, $V_{DD}=50\text{V}$ (Note 2) | E_{AS} | 6 | mJ | |
| Power Dissipation | P_D | $T_C=25^{\circ}\text{C}$ (Note 1) | 50 | W |
| | | $T_C=100^{\circ}\text{C}$ (Note 1) | 25 | |
| | P_{DSM} | $T_A=25^{\circ}\text{C}$ (Note 2) | 2 | |
| | | $T_A=70^{\circ}\text{C}$ (Note 2) | 1.3 | |
| Maximum Temperature for Soldering @ Lead at 0.063 in(1.6mm) from case for 10 seconds | T_L | 300 | $^{\circ}\text{C}$ | |
| Maximum Temperature for Soldering @ Package Body for 10 seconds | T_{PKG} | 260 | | |
| Operating Junction and Storage Temperature | T_j, T_{stg} | -55~+175 | | |

*Drain current limited by maximum junction temperature

Thermal Data

| Parameter | Symbol | Value | Unit |
|-------------------------------------------------------|-----------------|-------|-----------------------------|
| Thermal Resistance, Junction-to-case, max | $R_{\theta JC}$ | 3 | $^{\circ}\text{C}/\text{W}$ |
| Thermal Resistance, Junction-to-ambient, max (Note 2) | $R_{\theta JA}$ | 62.5 | $^{\circ}\text{C}/\text{W}$ |

Note : 1. The power dissipation P_D is based on $T_{J(MAX)}=175^{\circ}\text{C}$, using junction-to-case thermal resistance, and is more useful in setting the upper dissipation limit for cases where additional heatsinking is used.

2. The value of $R_{\theta JA}$ is measured with the device mounted on 1 in² FR-4 board with 2 oz. copper, in a still air environment with $T_A=25^{\circ}\text{C}$. The power dissipation P_{DSM} is based on $R_{\theta JA}$ and the maximum allowed junction temperature of 150°C . The value in any given application depends on the user's specific board design, and the maximum temperature of 175°C may be used if the PCB allows it.

3. Repetitive rating, pulse width limited by junction temperature $T_{J(MAX)}=175^{\circ}\text{C}$. Ratings are based on low frequency and low duty cycles to keep initial $T_J=25^{\circ}\text{C}$.



Characteristics (Tj=25°C, unless otherwise specified)

| Symbol | Min. | Typ. | Max. | Unit | Test Conditions |
|-------------------------------------|------|------|------|------|--------------------------------------------------------------------------------------|
| Static | | | | | |
| BV _{DSS} | 200 | - | - | V | V _{GS} =0V, I _D =250μA |
| ΔBV _{DSS} /ΔT _j | - | 0.2 | - | V/°C | Reference to 25°C, I _D =250μA |
| V _{GS(th)} | 2.0 | 3.1 | 4.0 | V | V _{DS} = V _{GS} , I _D =250μA |
| *G _{FS} | - | 12.5 | - | S | V _{DS} =10V, I _D =9A |
| I _{GSS} | - | - | ±100 | nA | V _{GS} =±20V |
| I _{DSS} | - | - | 1 | μA | V _{DS} =180V, V _{GS} =0V |
| | - | - | 10 | | V _{DS} =180V, V _{GS} =0V, T _j =125°C |
| *R _{DS(ON)} | - | 150 | 195 | mΩ | V _{GS} =10V, I _D =9A |
| Dynamic | | | | | |
| *Q _g | - | 20 | - | nC | V _{DS} =160V, I _D =17A, V _{GS} =10V |
| *Q _{gs} | - | 4 | - | | |
| *Q _{gd} | - | 8 | - | | |
| *t _{d(ON)} | - | 8 | - | ns | V _{DS} =100V, I _D =17A, V _{GS} =10V, R _G =6Ω |
| *t _r | - | 37 | - | | |
| *t _{d(OFF)} | - | 21 | - | | |
| *t _f | - | 38 | - | | |
| C _{iss} | - | 936 | - | pF | V _{GS} =0V, V _{DS} =25V, f=1MHz |
| C _{oss} | - | 83 | - | | |
| C _{rss} | - | 32 | - | | |
| R _g | - | 4.7 | - | Ω | V _{DS} =0V, f=1MHz |
| Source-Drain Diode | | | | | |
| *I _S | - | - | 17 | A | |
| *I _{SM} | - | - | 34 | | |
| *V _{SD} | - | 0.87 | 1.2 | V | I _S =17A, V _{GS} =0V |
| *t _{rr} | - | 75 | - | ns | V _{GS} =0, I _F =17A, dI _F /dt=100A/μs |
| *Q _{rr} | - | 225 | - | nC | |

*Pulse Test : Pulse Width ≤300μs, Duty Cycle≤2%

Typical Characteristics

Typical Output Characteristics

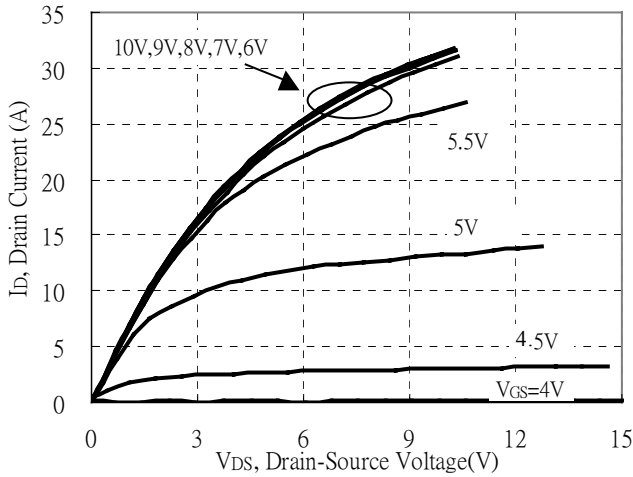

Brekdown Voltage vs Ambient Temperature

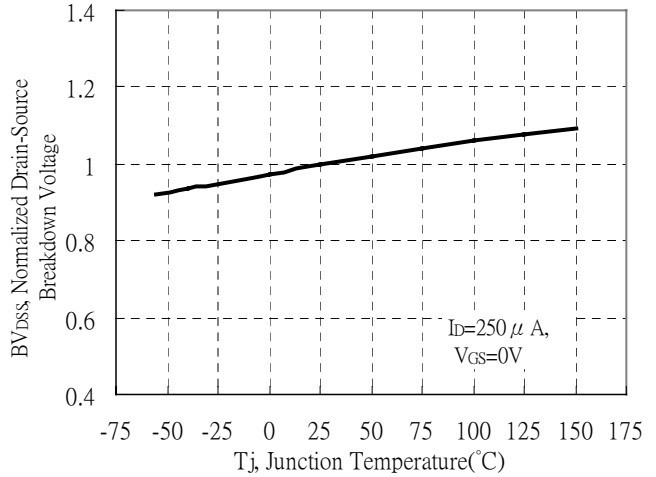

Static Drain-Source On-State resistance vs Drain Current

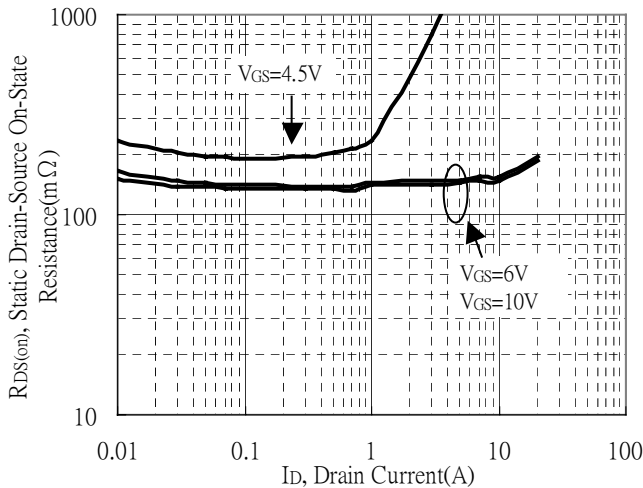

Reverse Drain Current vs Source-Drain Voltage

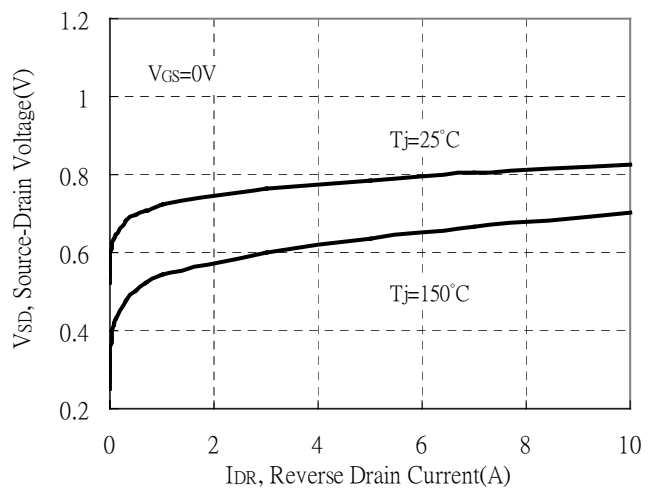

Static Drain-Source On-State Resistance vs Gate-Source Voltage

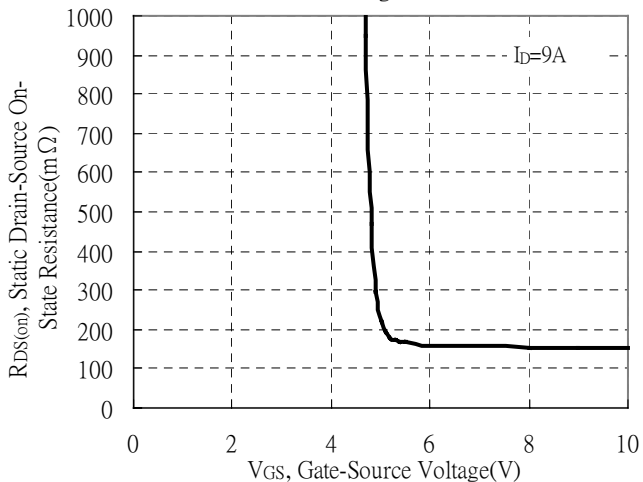

Drain-Source On-State Resistance vs Junction Temperature

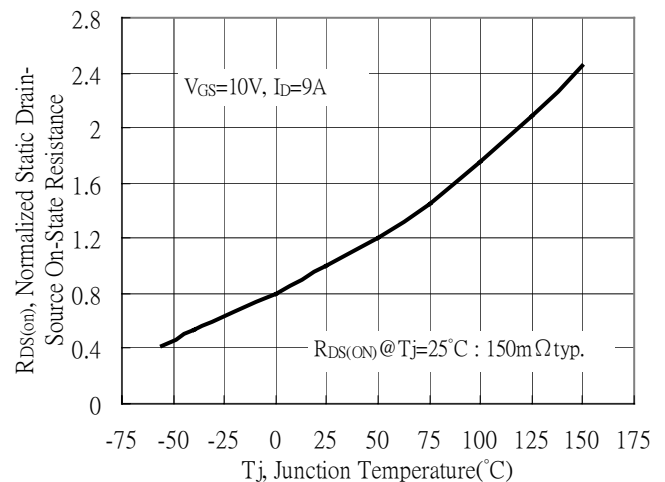

Typical Characteristics(Cont.)

Capacitance vs Drain-to-Source Voltage

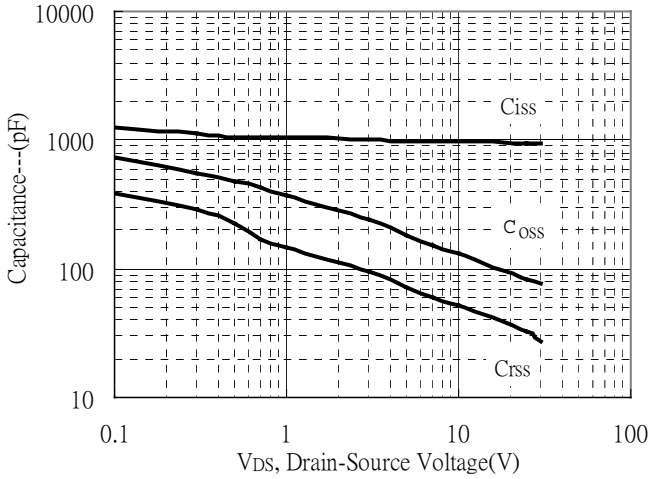

Threshold Voltage vs Junction Temperature

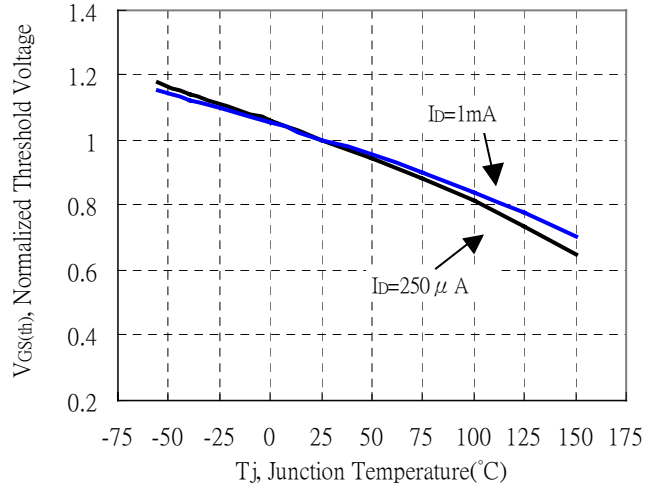

Forward Transfer Admittance vs Drain Current

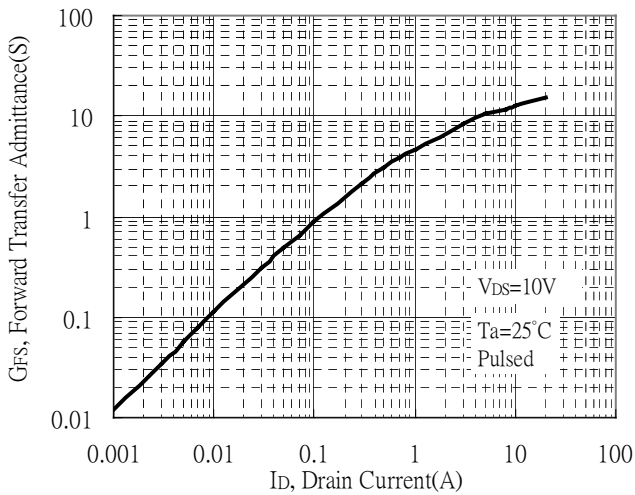

Gate Charge Characteristics

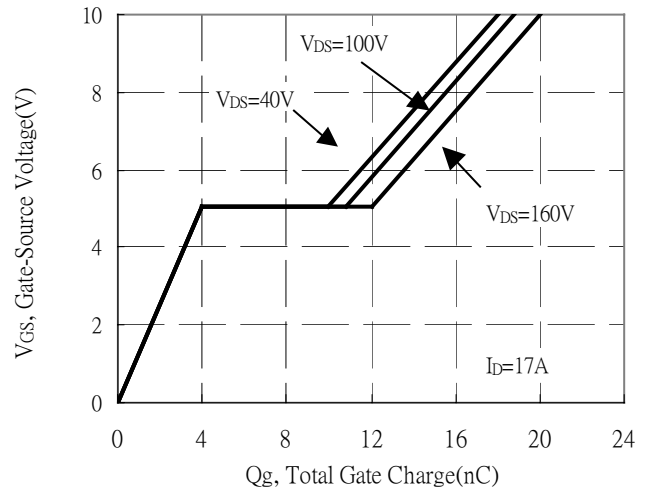

Maximum Safe Operating Area

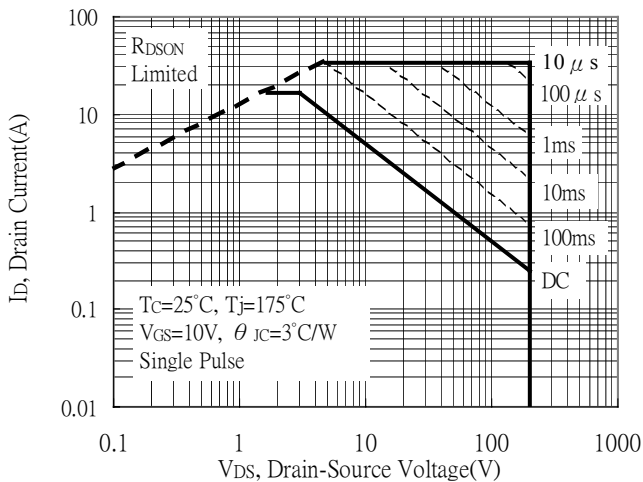

Maximum Drain Current vs Case Temperature

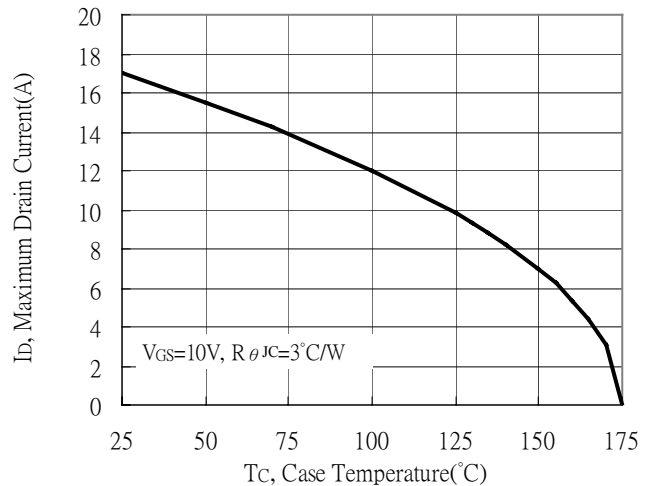

Typical Characteristics(Cont.)

Typical Transfer Characteristics

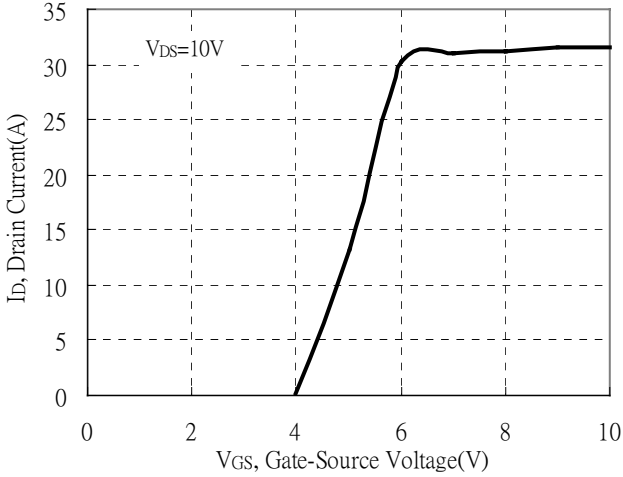

Single Pulse Power Rating, Junction to Case

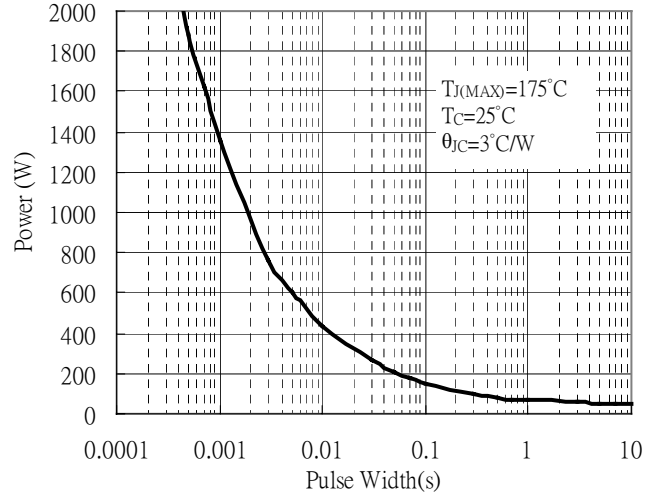

Transient Thermal Response Curves

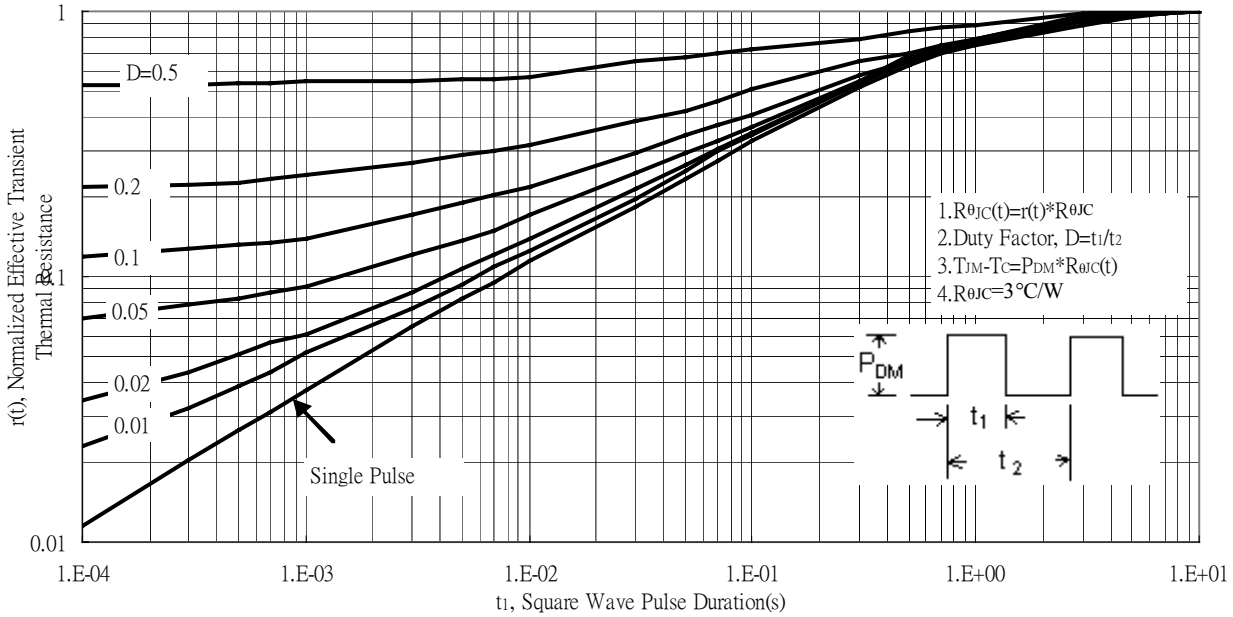

Recommended wave soldering condition

| | | |
|-----------------|------------------|-----------------|
| Product | Peak Temperature | Soldering Time |
| Pb-free devices | 260 +0/-5 °C | 5 +1/-1 seconds |

Recommended temperature profile for IR reflow

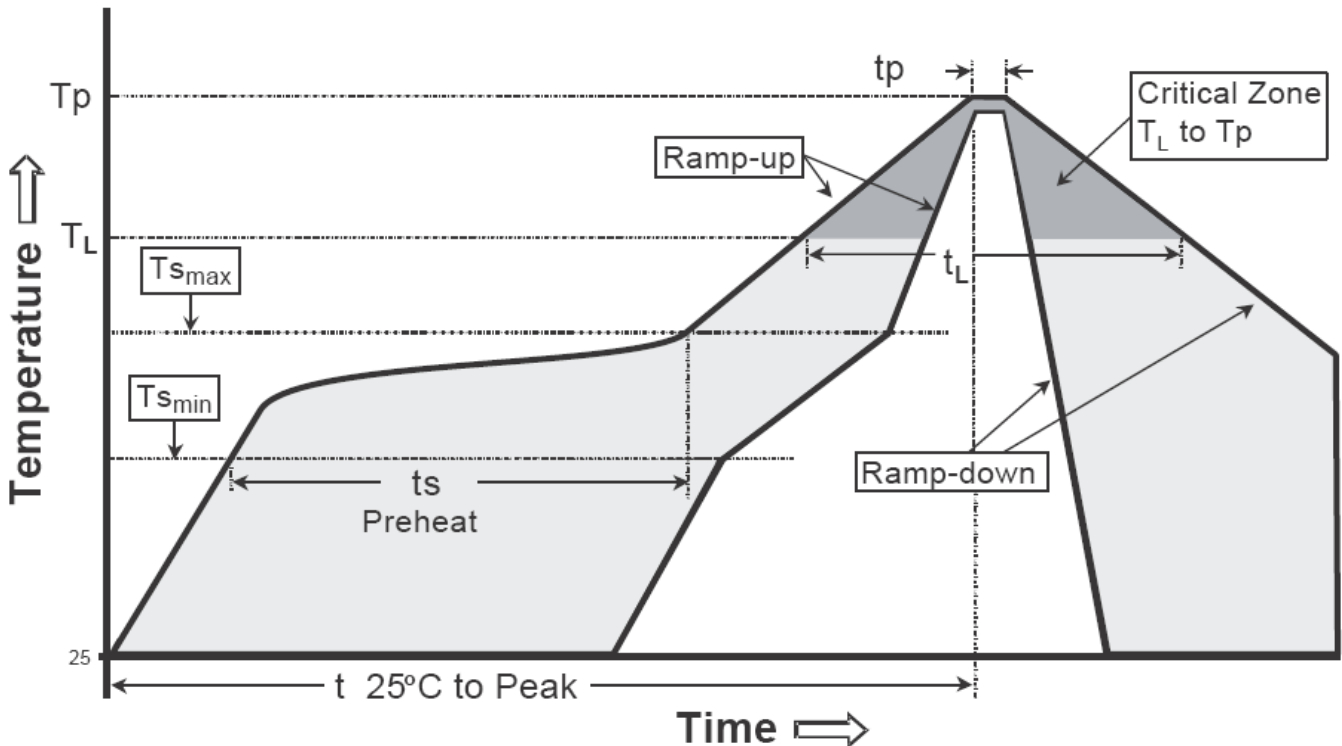

| Profile feature | Sn-Pb eutectic Assembly | Pb-free Assembly |
|-------------------------------------------------------------|-------------------------|------------------|
| Average ramp-up rate (T _{smax} to T _p) | 3°C/second max. | 3°C/second max. |
| Preheat | | |
| -Temperature Min(T _{s min}) | 100°C | 150°C |
| -Temperature Max(T _{s max}) | 150°C | 200°C |
| -Time(t _{s min} to t _{s max}) | 60-120 seconds | 60-180 seconds |
| Time maintained above: | | |
| -Temperature (T _L) | 183°C | 217°C |
| - Time (t _L) | 60-150 seconds | 60-150 seconds |
| Peak Temperature(T _P) | 240 +0/-5 °C | 260 +0/-5 °C |
| Time within 5°C of actual peak temperature(tp) | 10-30 seconds | 20-40 seconds |
| Ramp down rate | 6°C/second max. | 6°C/second max. |
| Time 25 °C to peak temperature | 6 minutes max. | 8 minutes max. |

Note : All temperatures refer to topside of the package, measured on the package body surface.

TO-220FP Dimension

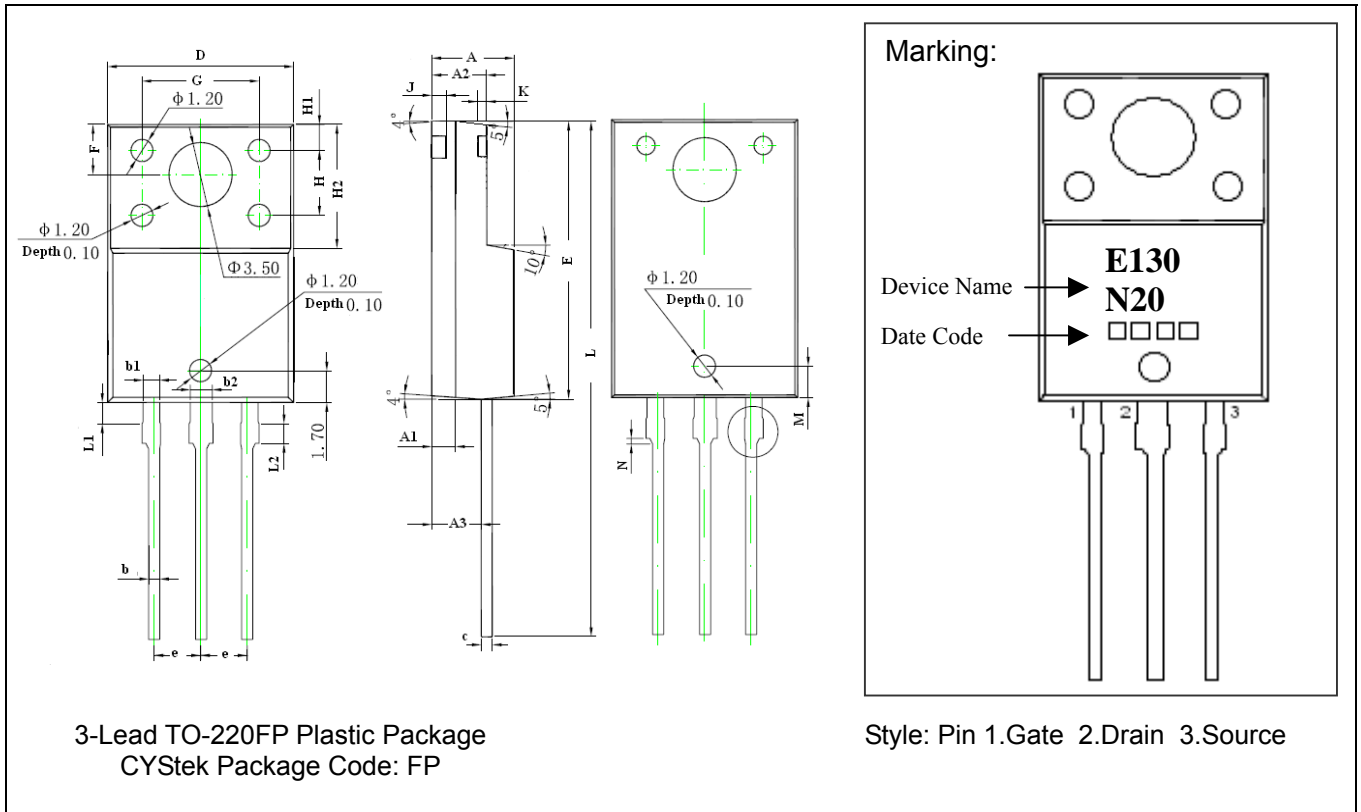

3-Lead TO-220FP Plastic Package
 CYStek Package Code: FP

Marking:
 Device Name → **E130**
 N20
 Date Code → □□□□

Style: Pin 1.Gate 2.Drain 3.Source

*Typical

| DIM | Inches | | Millimeters | | DIM | Inches | | Millimeters | |
|-----|-----------|-------|-------------|-------|-----|-----------|-------|-------------|-------|
| | Min. | Max. | Min. | Max. | | Min. | Max. | Min. | Max. |
| A | 0.171 | 0.183 | 4.35 | 4.65 | G | 0.246 | 0.258 | 6.25 | 6.55 |
| A1 | 0.051 REF | | 1.300 REF | | H | 0.138 REF | | 3.50 REF | |
| A2 | 0.112 | 0.124 | 2.85 | 3.15 | H1 | 0.055 REF | | 1.40 REF | |
| A3 | 0.102 | 0.110 | 2.60 | 2.80 | H2 | 0.256 | 0.272 | 6.50 | 6.90 |
| b | 0.020 | 0.030 | 0.50 | 0.75 | J | 0.031 REF | | 0.80 REF | |
| b1 | 0.031 | 0.041 | 0.80 | 1.05 | K | 0.020 | | 0.50 REF | |
| b2 | 0.047 REF | | 1.20 REF | | L | 1.102 | 1.118 | 28.00 | 28.40 |
| c | 0.020 | 0.030 | 0.500 | 0.750 | L1 | 0.043 | 0.051 | 1.10 | 1.30 |
| D | 0.396 | 0.404 | 10.06 | 10.26 | L2 | 0.036 | 0.043 | 0.92 | 1.08 |
| E | 0.583 | 0.598 | 14.80 | 15.20 | M | 0.067 REF | | 1.70 REF | |
| e | 0.100 * | | 2.54* | | N | 0.012 REF | | 0.30 REF | |
| F | 0.106 REF | | 2.70 REF | | | | | | |

- Notes: 1.Controlling dimension: millimeters.
 2.Maximum lead thickness includes lead finish thickness, and minimum lead thickness is the minimum thickness of base material.
 3.If there is any question with packing specification or packing method, please contact your local CYStek sales office.

Material:

- Lead: Pure tin plated.
- Mold Compound: Epoxy resin family, flammability solid burning class: UL94V-0.

Important Notice:

- All rights are reserved. Reproduction in whole or in part is prohibited without the prior written approval of CYStek.
- CYStek reserves the right to make changes to its products without notice.
- CYStek **semiconductor products are not warranted to be suitable for use in Life-Support Applications, or systems.**
- CYStek assumes no liability for any consequence of customer product design, infringement of patents, or application assistance.