

P-Channel Enhancement Mode Power MOSFET

MTE090P12V8

Features

- Single Drive Requirement
- Low On Resistance
- Fast Switching Characteristic

BV_{DSS}	-120V
$I_D@V_{GS}=-10V, T_C=25^{\circ}C$	-12A
$I_D@V_{GS}=-10V, T_A=25^{\circ}C$	-2.8A
$R_{DS(ON) typ. @ V_{GS}=-10V, I_D=-2A}$	115mΩ

Equivalent Circuit

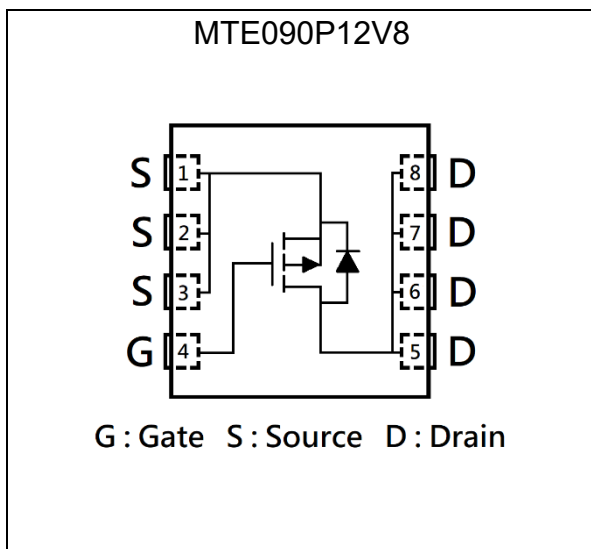

Outline

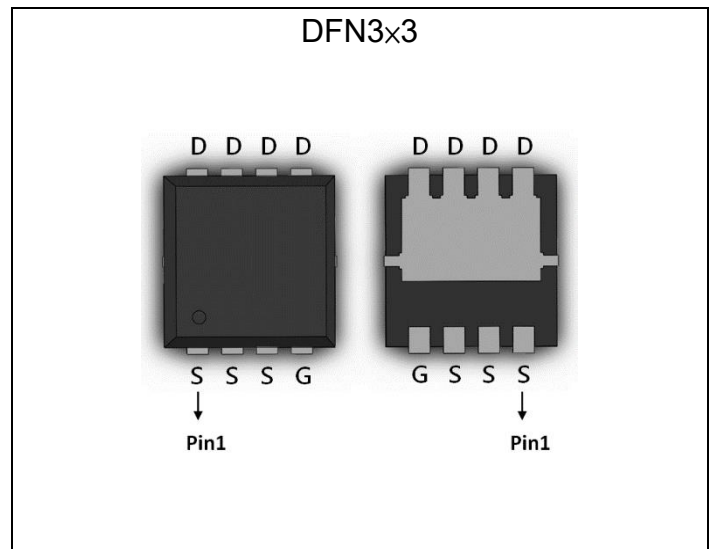

Ordering Information

Device	Package	Shipping
MTE090P12V8-0-T6-G	DFN3x3 (Pb-free lead plating and halogen-free package)	3000 pcs / Tape & Reel

- ↑ Environment friendly grade : S for RoHS compliant products, G for RoHS compliant and green compound products
- ↑ Packing spec, T6 : 3000 pcs / tape & reel, 13" reel
- ↑ Product rank, zero for no rank products
- ↑ Product name

**Absolute Maximum Ratings (T_A=25°C)**

Parameter	Symbol	Limits	Unit	
Drain-Source Voltage	V _{DS}	-120	V	
Gate-Source Voltage	V _{GS}	±20		
Continuous Drain Current @ V _{GS} =-10V, T _C =25°C	I _D	-12	A	
Continuous Drain Current @ V _{GS} =-10V, T _C =100°C		-7.6		
Continuous Drain Current @ V _{GS} =-10V, T _A =25°C		-2.8		
Continuous Drain Current @ V _{GS} =-10V, T _A =70°C		-2.3		
Pulsed Drain Current		I _{DM}		-36
Continuous Body Diode Forward Current @ T _C =25°C	I _S	-12	mJ	
Pulsed Body Diode Forward Current @ T _C =25°C	I _{SM}	-36		
Avalanche Current @ L=0.1mH	I _{AS}	-18		
Avalanche Energy @ L=0.5mH	E _{AS}	30	mJ	
Total Power Dissipation	P _D	T _C =25°C	43	W
		T _C =100°C	17	
		T _A =25°C	2.5	
		T _A =70°C	1.6	
Operating Junction and Storage Temperature Range	T _J , T _{stg}	-55~+150	°C	

Thermal Data

Parameter	Symbol	Steady State	Unit
Thermal Resistance, Junction-to-case	R _{θJC}	2.9	°C/W
Thermal Resistance, Junction-to-ambient	R _{θJA}	50	

Note:

- *a. The power dissipation P_D is based on T_{J(MAX)}=150°C, using junction-to-case thermal resistance, and is more useful in setting the upper dissipation limit for cases where additional heatsinking is used.
- *b. The value of R_{θJA} is measured with the device mounted on 1 in² FR-4 board with 2 oz. copper, in a still air environment with T_A=25°C. The power dissipation P_D is based on R_{θJA} and the maximum allowed junction temperature of 150°C. The value in any given application depends on the user's specific board design.
- *c. Repetitive rating, pulse width limited by junction temperature T_{J(MAX)}=150°C. Ratings are based on low frequency and low duty cycles to keep initial T_J=25°C.



Electrical Characteristics (T_A=25°C, unless otherwise specified)

Symbol	Min.	Typ.	Max.	Unit	Test Conditions
Static					
BV _{DSS}	-120	-	-	V	V _{GS} =0V, I _D =-250μA
V _{GS(th)}	-2	-	-4		V _{DS} =V _{GS} , I _D =-250μA
G _{FS}	-	6.5	-	S	V _{DS} =-10V, I _D =-2A
I _{GSS}	-	-	±100	nA	V _{GS} =±20V, V _{DS} =0V
I _{DSS}	-	-	-1	μA	V _{DS} =-96V, V _{GS} =0V
R _{DS(on)}	-	115	160	mΩ	V _{GS} =-10V, I _D =-2A
Dynamic					
C _{iss}	-	1250	-	pF	V _{DS} =-60V, V _{GS} =0V, f=1MHz
C _{oss}	-	66	-		
C _{rss}	-	49	-		
R _g	-	5.4	-	Ω	f=1MHz
Q _g *1, 2	-	24	-	nC	V _{DS} =-60V, I _D =-2A, V _{GS} =-10V
Q _{gs} *1, 2	-	6	-		
Q _{gd} *1, 2	-	6	-		
t _{d(ON)} *1, 2	-	15	-	ns	V _{DS} =-60V, I _D =-2A, V _{GS} =-10V, R _{GS} =6Ω
t _r *1, 2	-	21	-		
t _{d(OFF)} *1, 2	-	48	-		
t _f *1, 2	-	18	-		
Source-Drain Diode					
V _{SD} *1	-	-0.78	-1.2	V	I _S =-2A, V _{GS} =0V
t _{rr}	-	28	-	ns	I _F =-2A, dI _F /dt=100A/μs
Q _{rr}	-	35	-	nC	

Note:

*1. Pulse Test : Pulse Width ≤300μs, Duty Cycle≤2%

*2. Independent of operating temperature



Typical Characteristics

Typical Output Characteristics

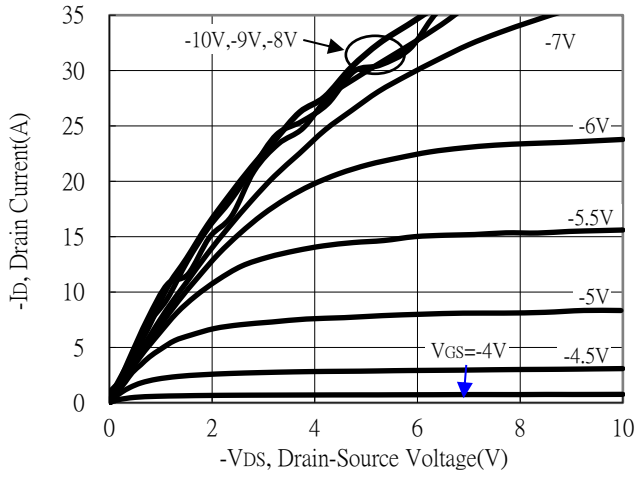

Breakdown Voltage vs Ambient Temperature

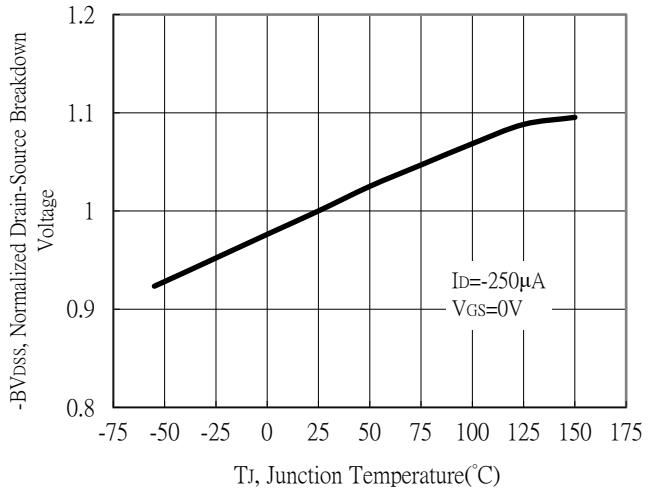

Static Drain-Source On-State resistance vs Drain Current

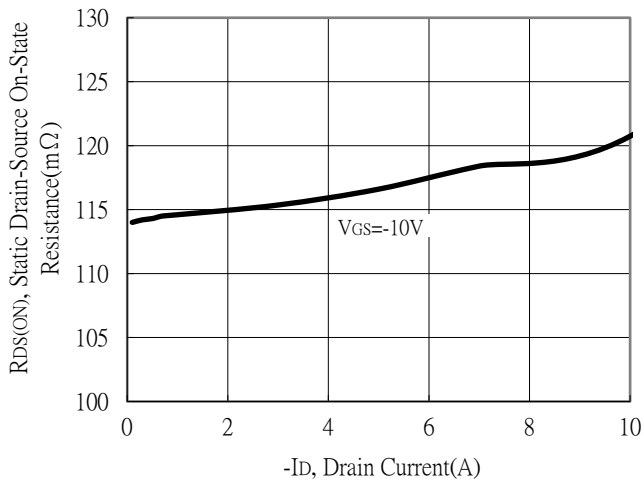

Body Diode Current vs Source-Drain Voltage

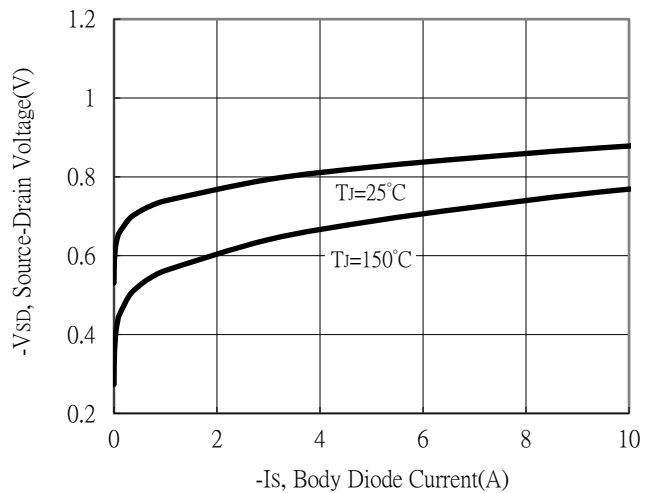

Static Drain-Source On-State Resistance vs Gate-Source Voltage

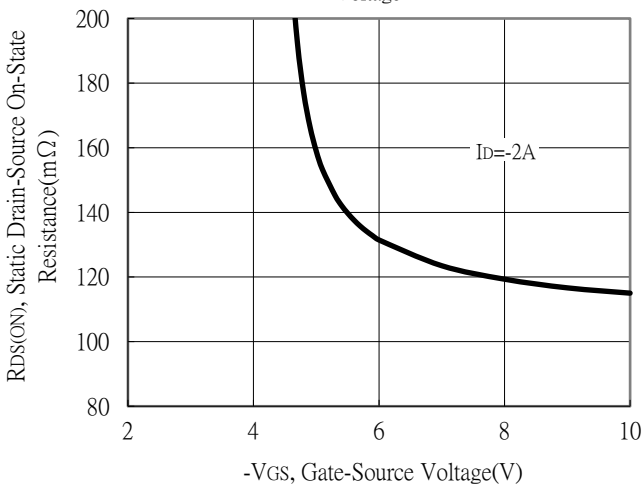

Drain-Source On-State Resistance vs Junction Temperature

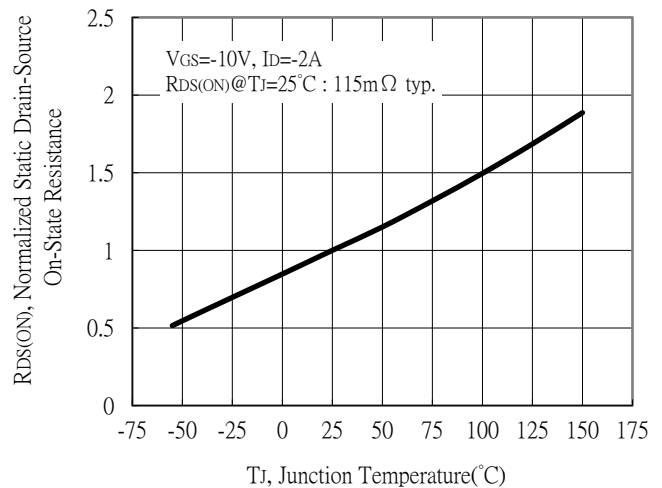

Typical Characteristics (Cont.)

Capacitance vs Drain-to-Source Voltage

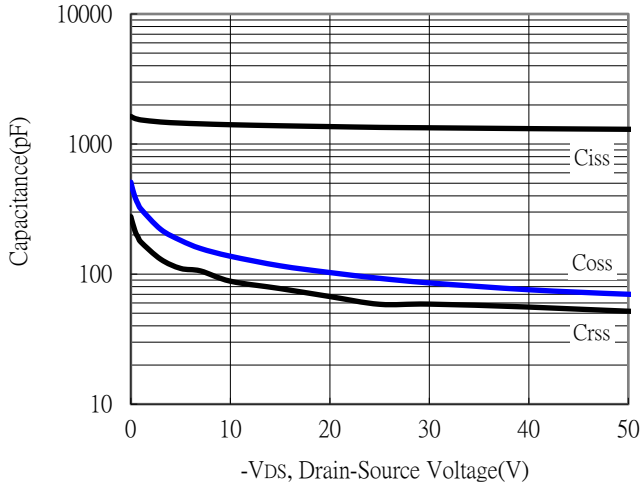

Threshold Voltage vs Junction Temperature

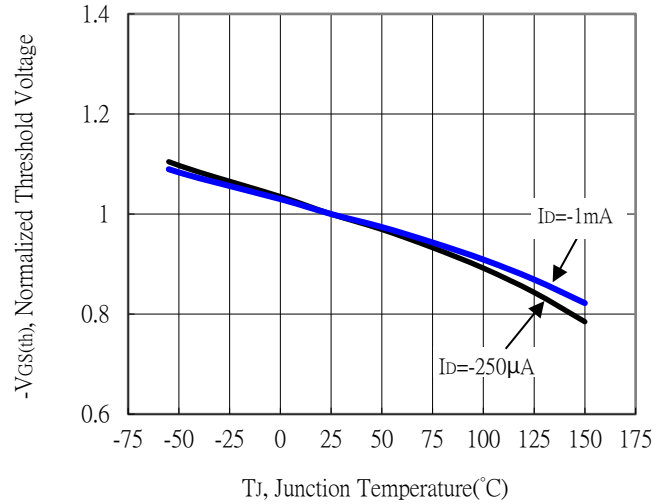

Forward Transfer Admittance vs Drain Current

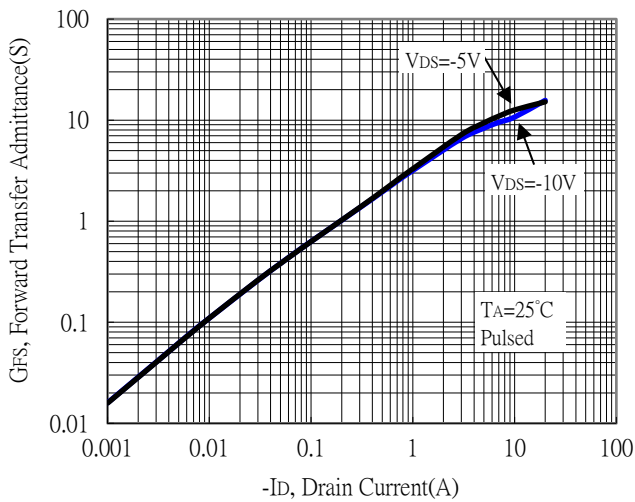

Gate Charge Characteristics

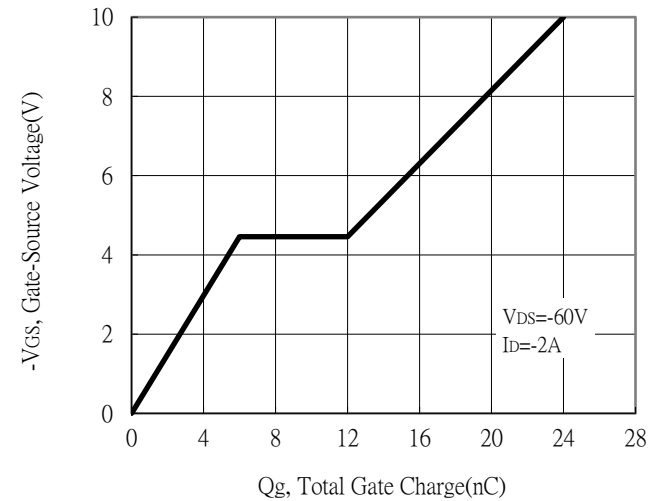

Maximum Safe Operating Area

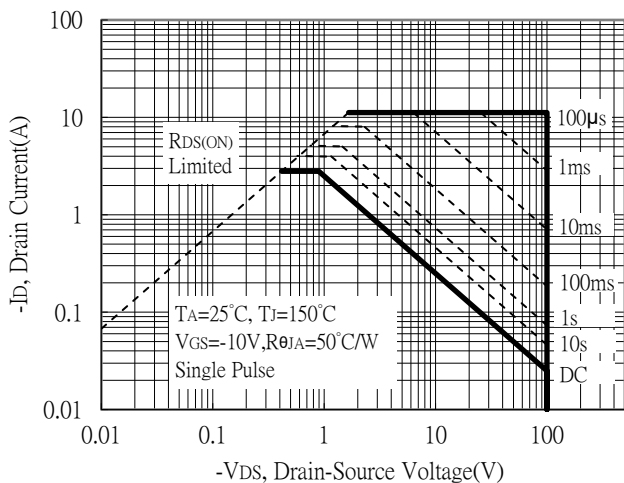

Maximum Drain Current vs Junction Temperature

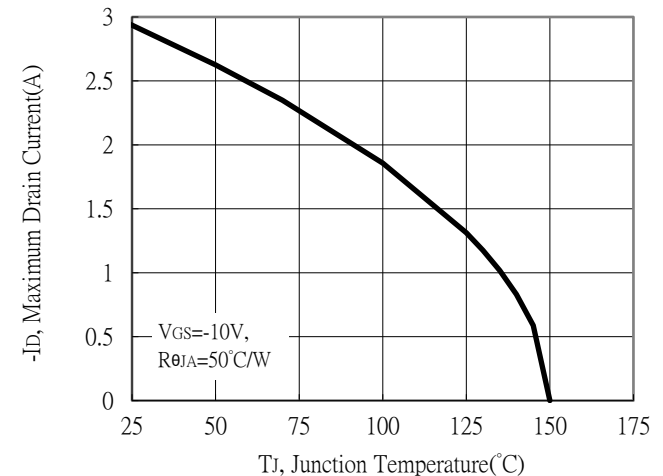

Typical Characteristics (Cont.)

Single Pulse Power Rating, Junction to Ambient

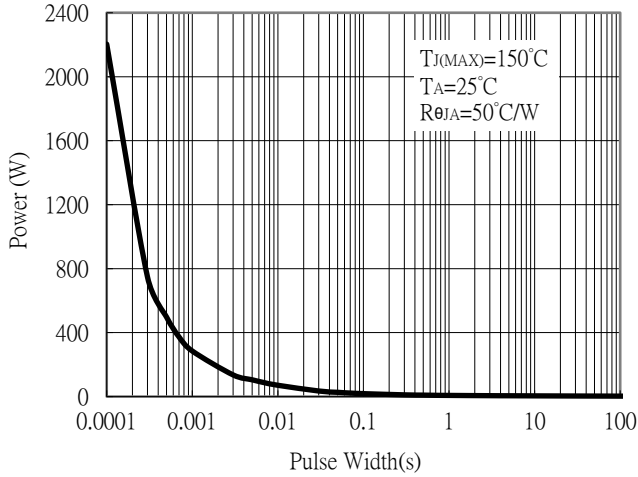

Transient Thermal Response Curves

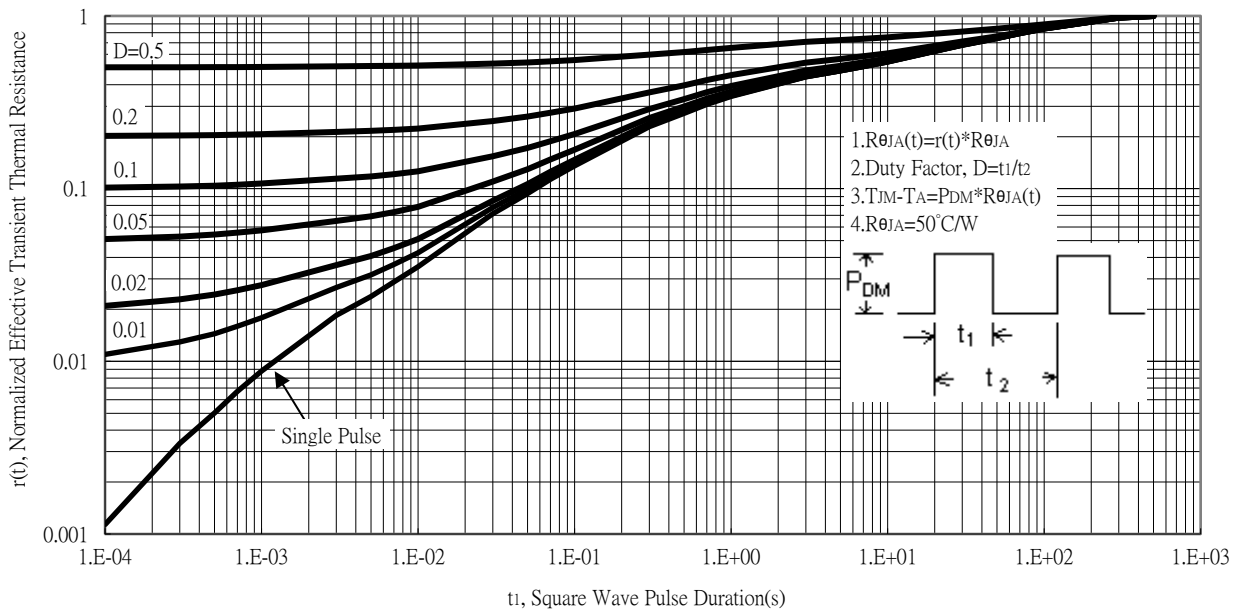

Recommended Soldering Footprint

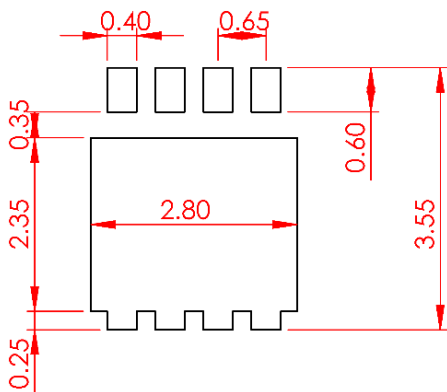

Unit : mm

Reel Dimension

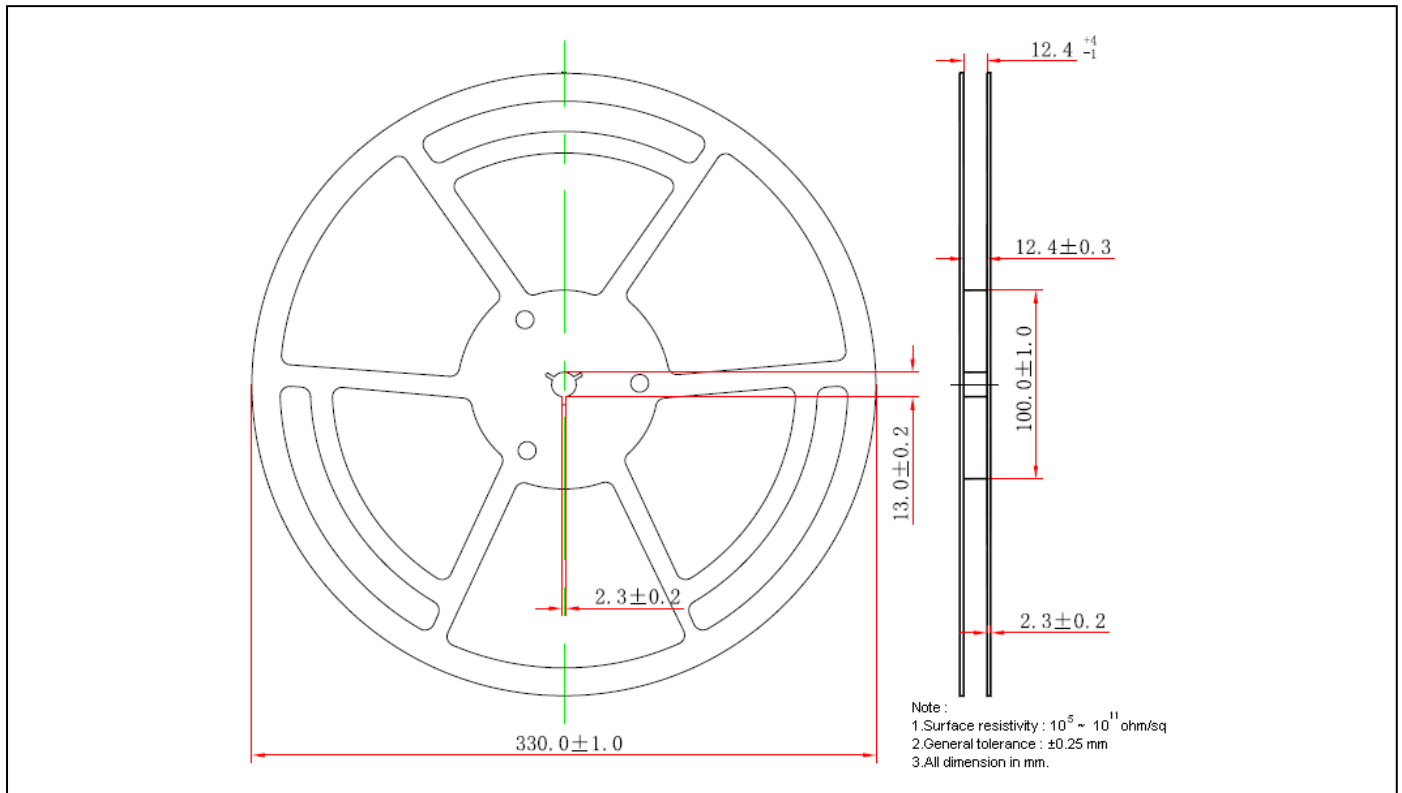

Carrier Tape Dimension

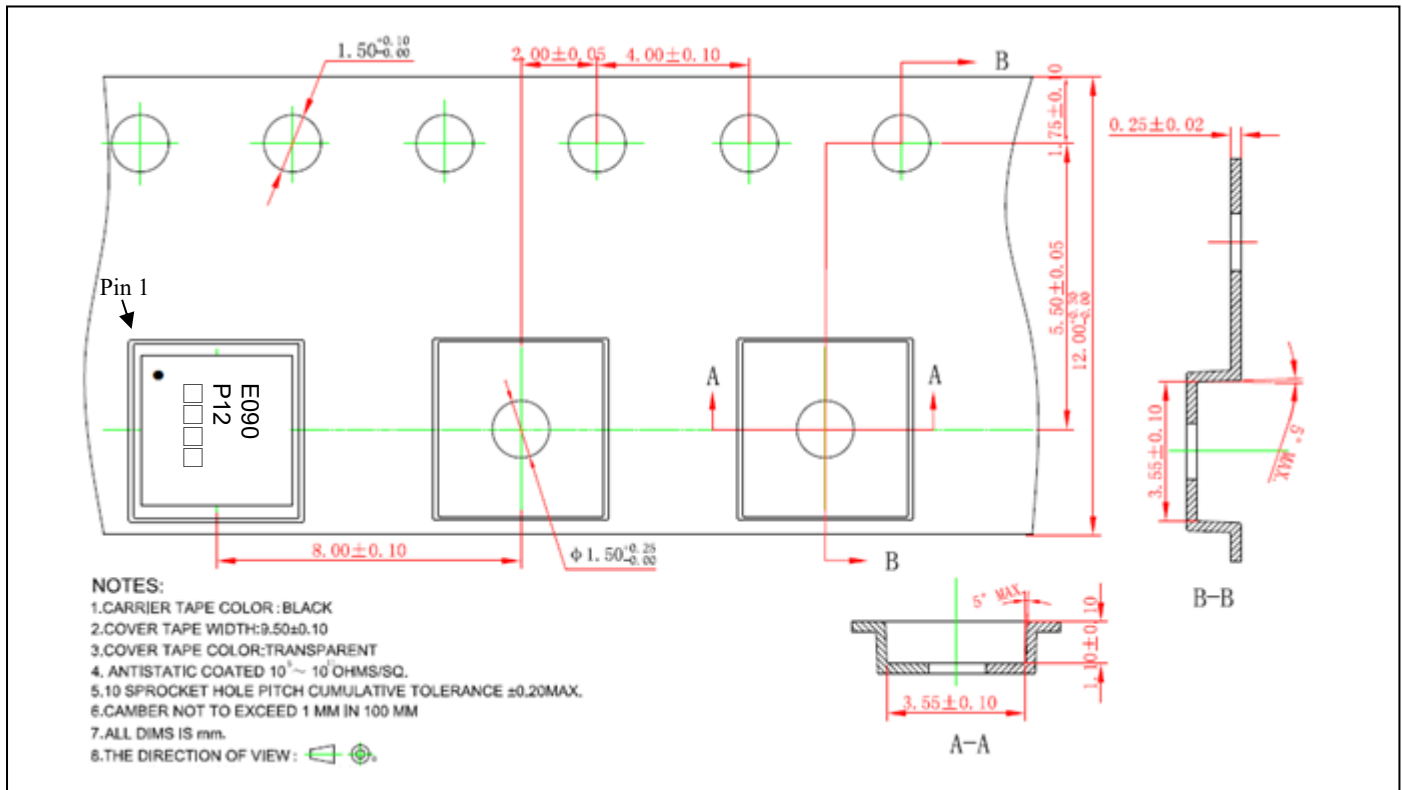

Recommended wave soldering condition

Product	Peak Temperature	Soldering Time
Pb-free devices	260 +0/-5 °C	5 +1/-1 seconds

Recommended temperature profile for IR reflow

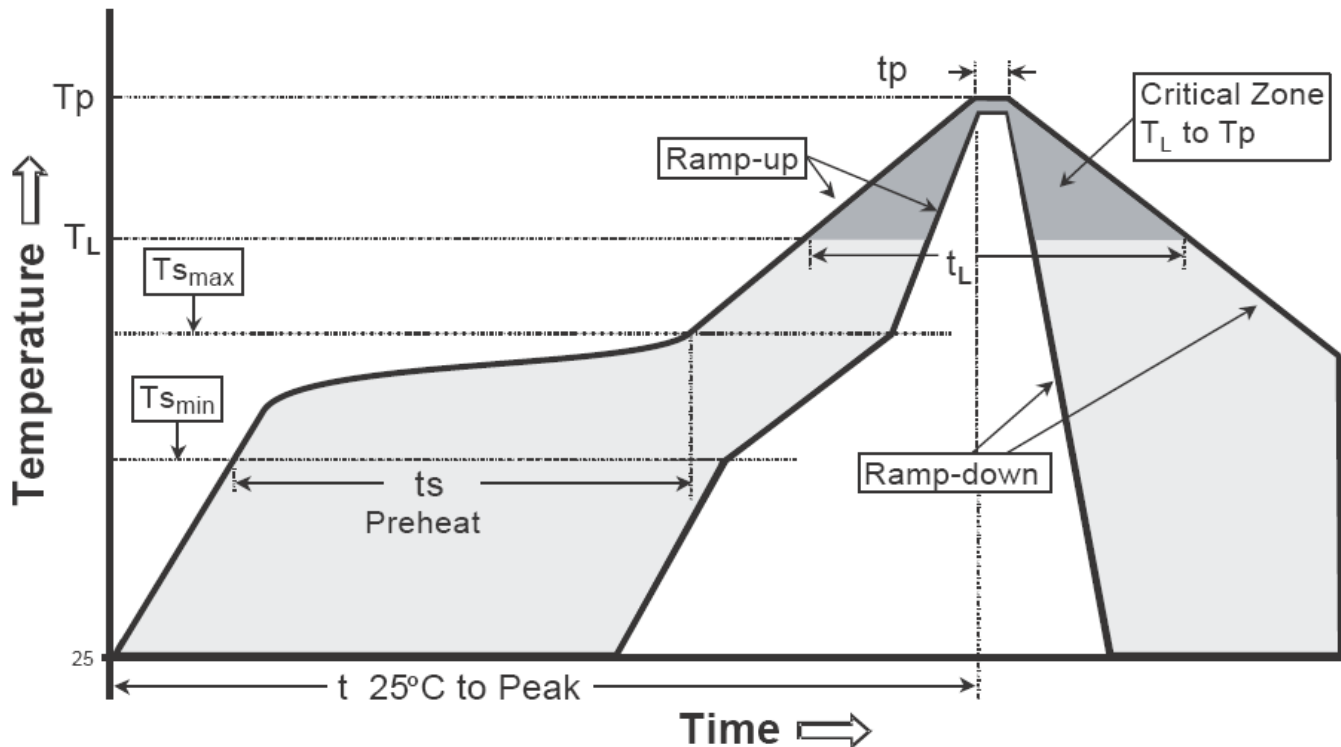

Profile feature	Sn-Pb eutectic Assembly	Pb-free Assembly
Average ramp-up rate (T _{smax} to T _p)	3°C/second max.	3°C/second max.
Preheat		
-Temperature Min(T _{s min})	100°C	150°C
-Temperature Max(T _{s max})	150°C	200°C
-Time(t _{s min} to t _{s max})	60-120 seconds	60-180 seconds
Time maintained above:		
-Temperature (T _L)	183°C	217°C
- Time (t _L)	60-150 seconds	60-150 seconds
Peak Temperature(T _P)	240 +0/-5 °C	260 +0/-5 °C
Time within 5°C of actual peak temperature(tp)	10-30 seconds	20-40 seconds
Ramp down rate	6°C/second max.	6°C/second max.
Time 25 °C to peak temperature	6 minutes max.	8 minutes max.

Note : All temperatures refer to topside of the package, measured on the package body surface.

DFN3x3 Dimension

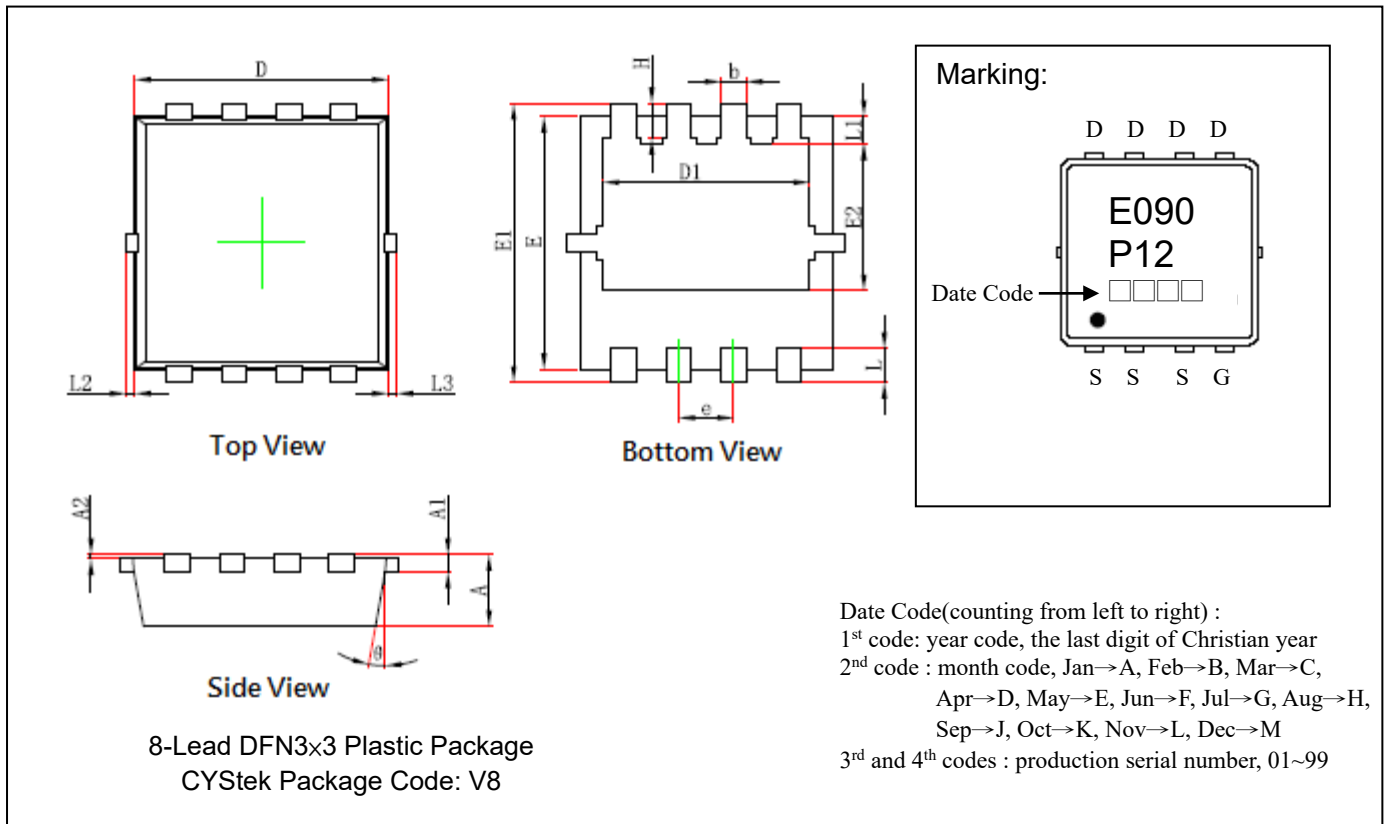

8-Lead DFN3x3 Plastic Package
 CYStek Package Code: V8

Marking:

D D D D
 E090
 P12
 Date Code: □□□□
 S S S G

Date Code(counting from left to right) :
 1st code: year code, the last digit of Christian year
 2nd code : month code, Jan→A, Feb→B, Mar→C,
 Apr→D, May→E, Jun→F, Jul→G, Aug→H,
 Sep→J, Oct→K, Nov→L, Dec→M
 3rd and 4th codes : production serial number, 01~99

DIM	Inches		Millimeters		DIM	Inches		Millimeters	
	Min.	Max.	Min.	Max.		Min.	Max.	Min.	Max.
A	0.026	0.033	0.650	0.850	b	0.008	0.016	0.200	0.400
A1	0.006	REF	0.152	REF	e	0.022	0.030	0.550	0.750
A2	0.000	0.002	0.000	0.050	L	0.012	0.020	0.300	0.500
D	0.114	0.122	2.900	3.100	L1	0.007	0.019	0.180	0.480
D1	0.091	0.102	2.300	2.600	L2	0.000	0.004	0.000	0.100
E	0.114	0.122	2.900	3.100	L3	0.000	0.004	0.000	0.100
E1	0.124	0.136	3.150	3.450	H	0.012	0.020	0.315	0.515
E2	0.060	0.076	1.535	1.935	θ	9°	13°	9°	13°

Notes: 1.Controlling dimension: millimeters.
 2.Maximum lead thickness includes lead finish thickness, and minimum lead thickness is the minimum thickness of base material.
 3.If there is any question with packing specification or packing method, please contact your local CYStek sales office.

Material:

- Lead: pure tin plated.
- Mold Compound: Epoxy resin family, flammability solid burning class: UL94V-0.

Important Notice:

- All rights are reserved. Reproduction in whole or in part is prohibited without the prior written approval of CYStek.
- CYStek reserves the right to make changes to its products without notice.
- CYStek **semiconductor products are not warranted to be suitable for use in Life-Support Applications, or systems.**
- CYStek assumes no liability for any consequence of customer product design, infringement of patents, or application assistance.