

N-Channel Enhancement Mode Power MOSFET

MTE032N15H8

Features

- Low On Resistance
- Low Gate Charge
- Fast Switching Characteristic

BV_{DSS}	150V
$I_D@V_{GS}=10V, T_C=25^{\circ}C$	25A
$I_D@V_{GS}=10V, T_A=25^{\circ}C$	5A
$R_{DS(ON)}@V_{GS}=10V, I_D=20A$	32mΩ

Equivalent Circuit

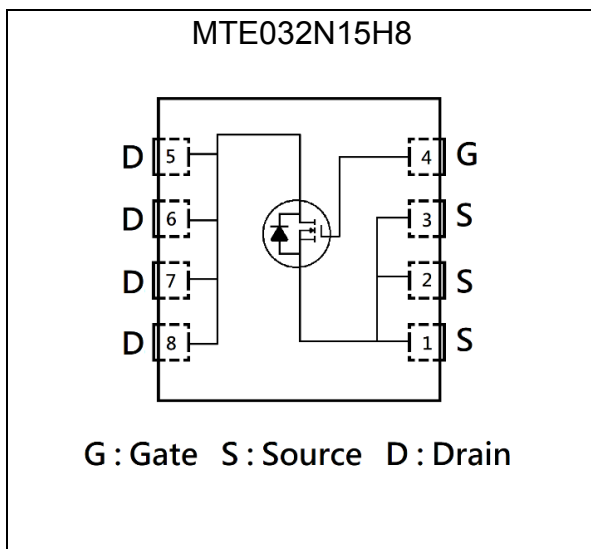

Outline

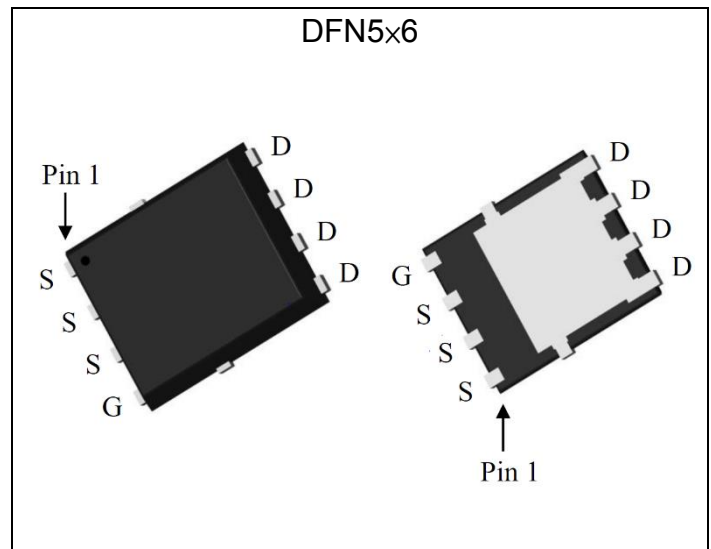

Ordering Information

Device	Package	Shipping
MTE032N15H8-0-T6-G	DFN5x6 (Pb-free lead plating and halogen-free package)	3000 pcs / Tape & Reel

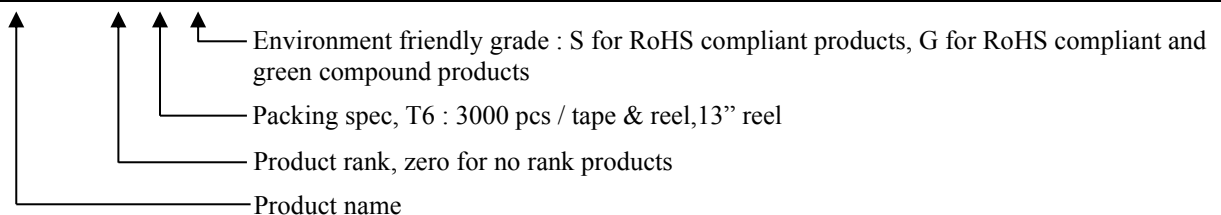

**Absolute Maximum Ratings (T_A=25°C)**

Parameter	Symbol	Limits	Unit	
Drain-Source Voltage	V _{DS}	150	V	
Gate-Source Voltage	V _{GS}	±20		
Continuous Drain Current @ V _{GS} =10V, T _C =25°C	I _D	25	A	
Continuous Drain Current @ V _{GS} =10V, T _C =100°C		16		
Continuous Drain Current @ V _{GS} =10V, T _A =25°C		5		
Continuous Drain Current @ V _{GS} =10V, T _A =70°C		4		
Pulsed Drain Current	I _{DM}	100		
Continuous Body Diode Forward Current @ T _C =25°C	I _S	25		
Avalanche Current @ L=0.1mH	I _{AS}	12		
Avalanche Energy @ L=0.5mH	E _{AS}	25	mJ	
Total Power Dissipation	P _D	T _C =25°C	62.5	W
		T _C =100°C	25	
		T _A =25°C	2.5	
		T _A =70°C	1.6	
Operating Junction and Storage Temperature Range	T _J , T _{stg}	-55~+150	°C	

Thermal Data

Parameter	Symbol	Steady State	Unit
Thermal Resistance, Junction-to-case	R _{θJC}	2	°C/W
Thermal Resistance, Junction-to-ambient	R _{θJA}	50	

Note:

- *a. The power dissipation P_D is based on T_{J(MAX)}=150°C, using junction-to-case thermal resistance, and is more useful in setting the upper dissipation limit for cases where additional heatsinking is used.
- *b. The value of R_{θJA} is measured with the device mounted on 1 in² FR-4 board with 2 oz. copper, in a still air environment with T_A=25°C. The power dissipation P_D is based on R_{θJA} and the maximum allowed junction temperature of 150°C. The value in any given application depends on the user's specific board design.
- *c. Repetitive rating, pulse width limited by junction temperature T_{J(MAX)}=150°C. Ratings are based on low frequency and low duty cycles to keep initial T_J=25°C.



Characteristics (T_A=25°C, unless otherwise specified)

Symbol	Min.	Typ.	Max.	Unit	Test Conditions
Static					
BV _{DSS}	150	-	-	V	V _{GS} =0V, I _D =250μA
V _{GS(th)}	2	-	4		V _{DS} =V _{GS} , I _D =250μA
G _{FS}	-	32	-	S	V _{DS} =5V, I _D =20A
I _{GSS}	-	-	±100	nA	V _{GS} =±20V, V _{DS} =0V
I _{DSS}	-	-	1	μA	V _{DS} =120V, V _{GS} =0V
R _{DS(ON)}	-	32	40	mΩ	V _{GS} =10V, I _D =20A
Dynamic					
C _{iSS}	-	2100	-	pF	V _{DS} =75V, V _{GS} =0V, f=1MHz
C _{oSS}	-	125	-		
C _{rSS}	-	55	-		
R _g	-	2.5	-	Ω	f=1MHz
Q _g *1, 2	-	45	-	nC	V _{DS} =75V, I _D =20A, V _{GS} =10V
Q _{gs} *1, 2	-	10	-		
Q _{gd} *1, 2	-	15	-		
t _{d(ON)} *1, 2	-	23	-	ns	V _{DS} =75V, I _D =20A, V _{GS} =10V, R _{GS} =6Ω
t _r *1, 2	-	21	-		
t _{d(OFF)} *1, 2	-	70	-		
t _f *1, 2	-	30	-		
Source-Drain Diode					
V _{SD} *1	-	0.85	1.2	V	I _S =12A, V _{GS} =0V
t _{rr}	-	50	-	ns	I _F =25A, dI _F /dt=250A/μs
Q _{rr}	-	330	-	nC	

Note:

*1. Pulse Test : Pulse Width ≤300μs, Duty Cycle≤2%

*2. Independent of operating temperature



Typical Characteristics

Typical Output Characteristics

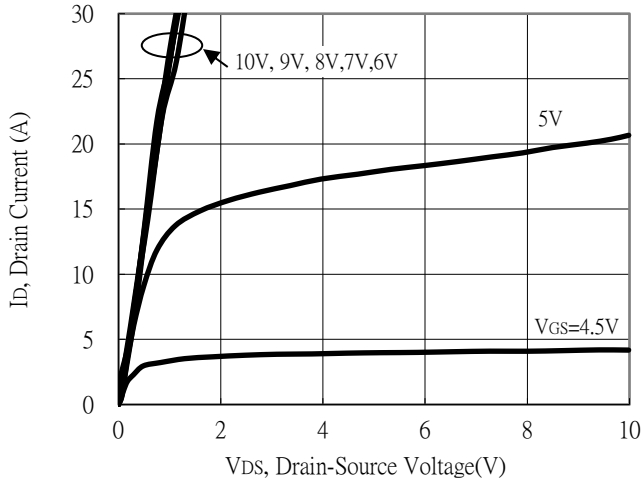

Breakdown Voltage vs Ambient Temperature

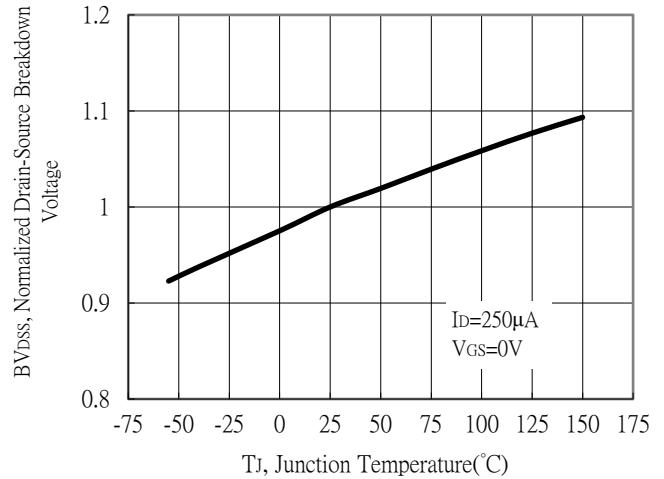

Static Drain-Source On-State resistance vs Drain Current

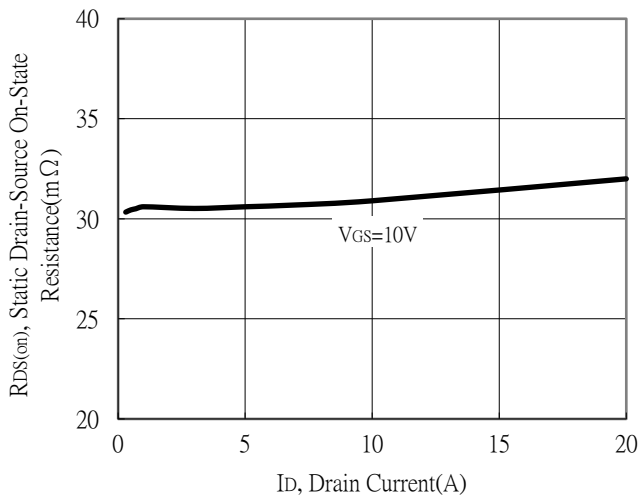

Body Diode Current vs Source-Drain Voltage

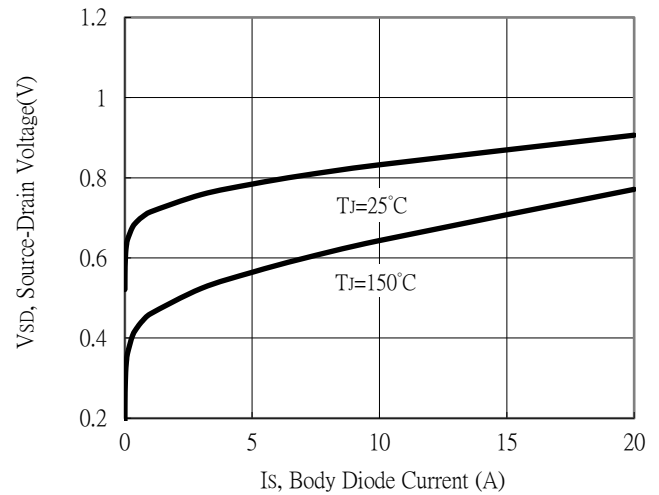

Static Drain-Source On-State Resistance vs Gate-Source Voltage

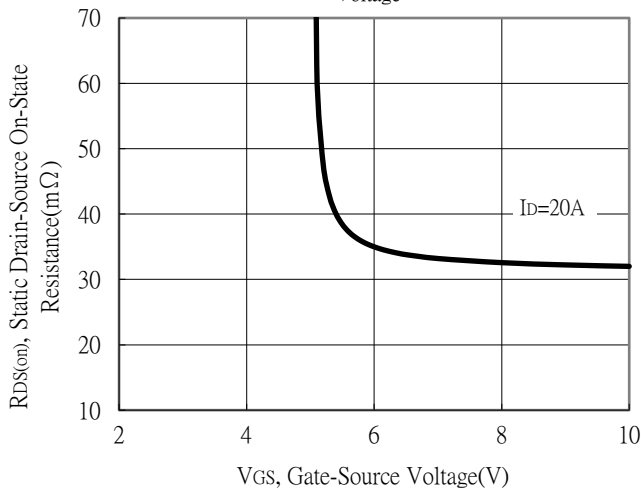

Drain-Source On-State Resistance vs Junction Temperature

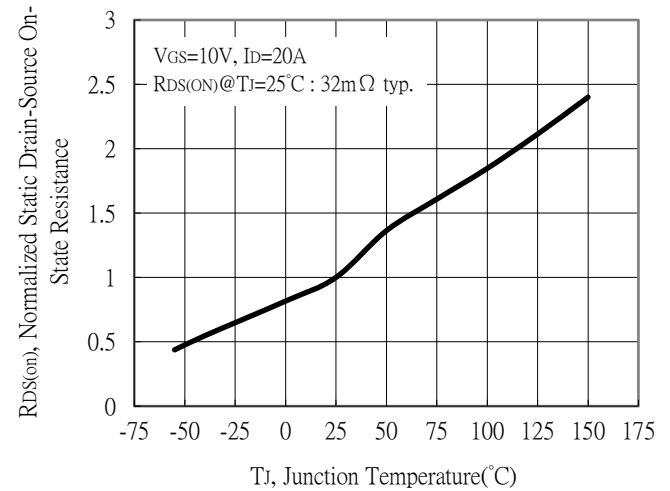

Typical Characteristics (Cont.)

Capacitance vs Drain-to-Source Voltage

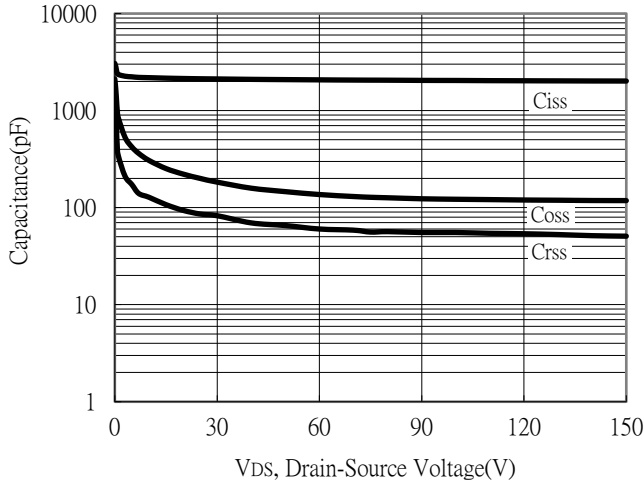

Threshold Voltage vs Junction Temperature

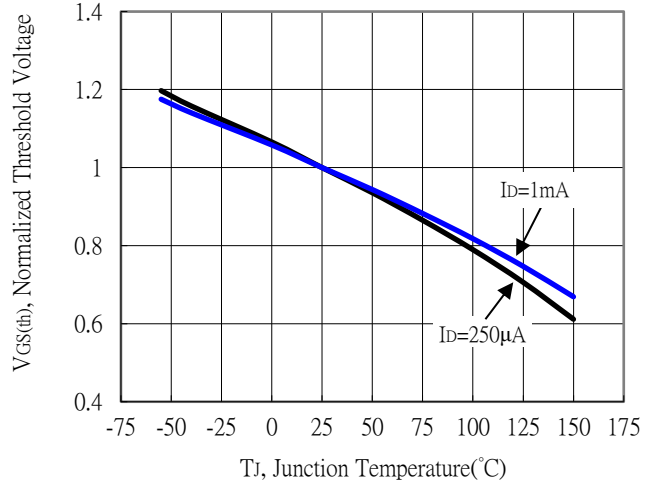

Forward Transfer Admittance vs Drain Current

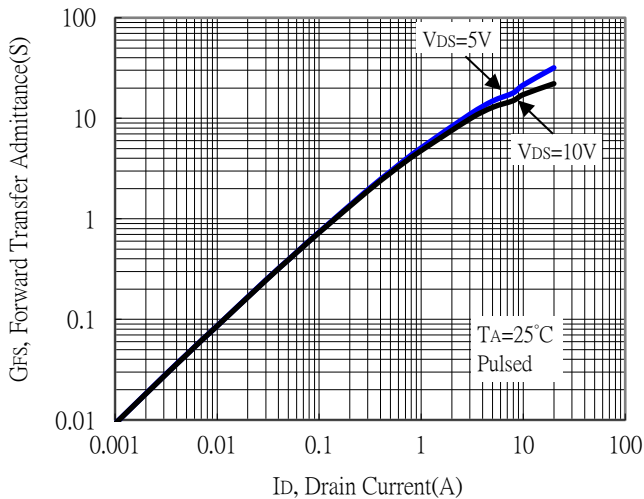

Gate Charge Characteristics

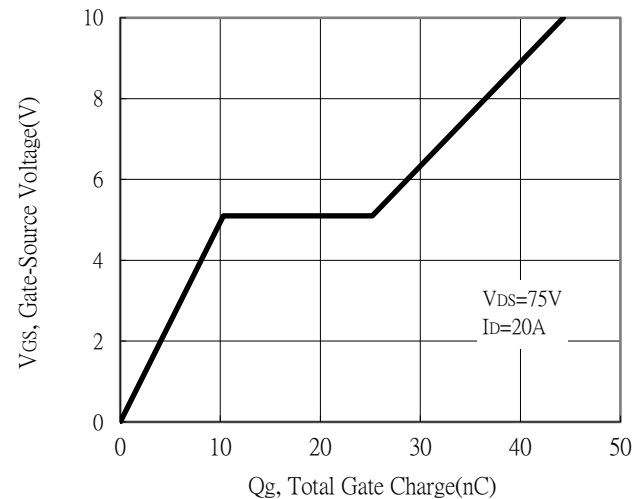

Maximum Safe Operating Area

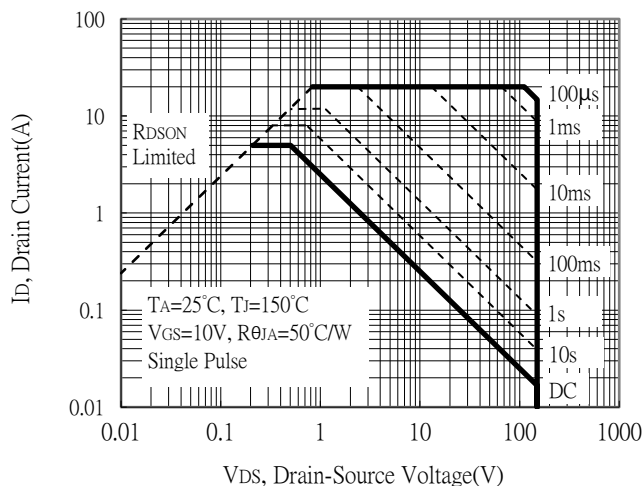

Maximum Drain Current vs Junction Temperature

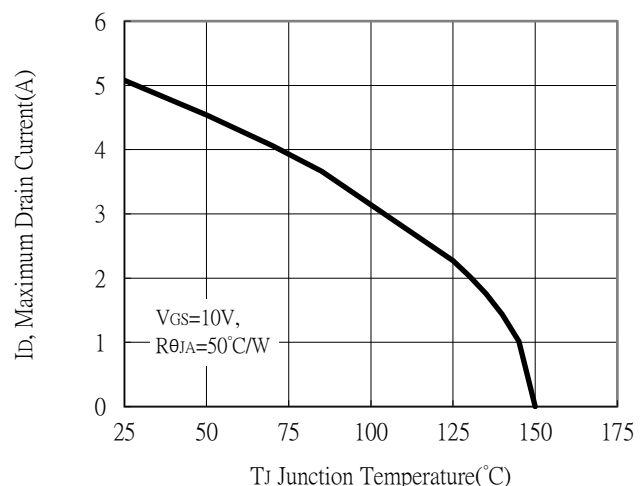

Typical Characteristics (Cont.)

Single Pulse Power Rating, Junction to Ambient

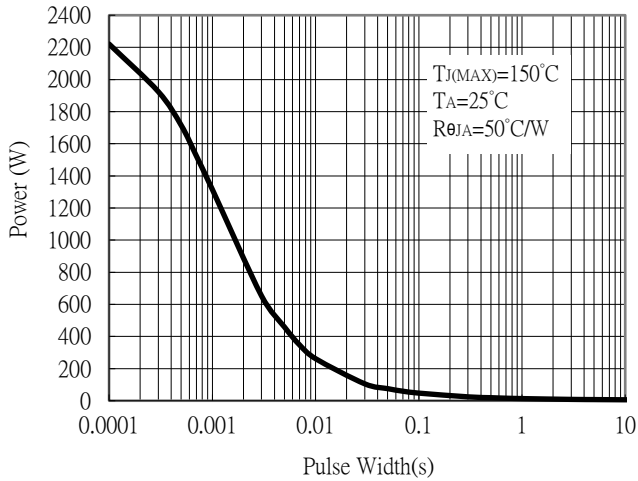

Transient Thermal Response Curves

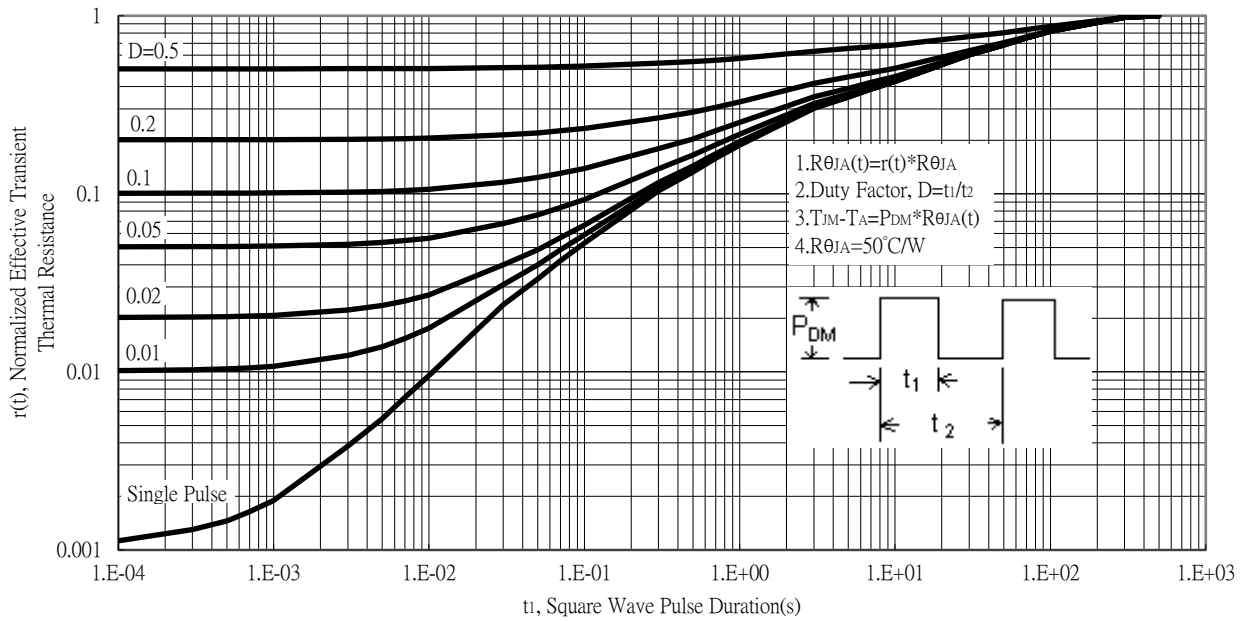

Recommended wave soldering condition

Product	Peak Temperature	Soldering Time
Pb-free devices	260 +0/-5 °C	5 +1/-1 seconds

Recommended temperature profile for IR reflow

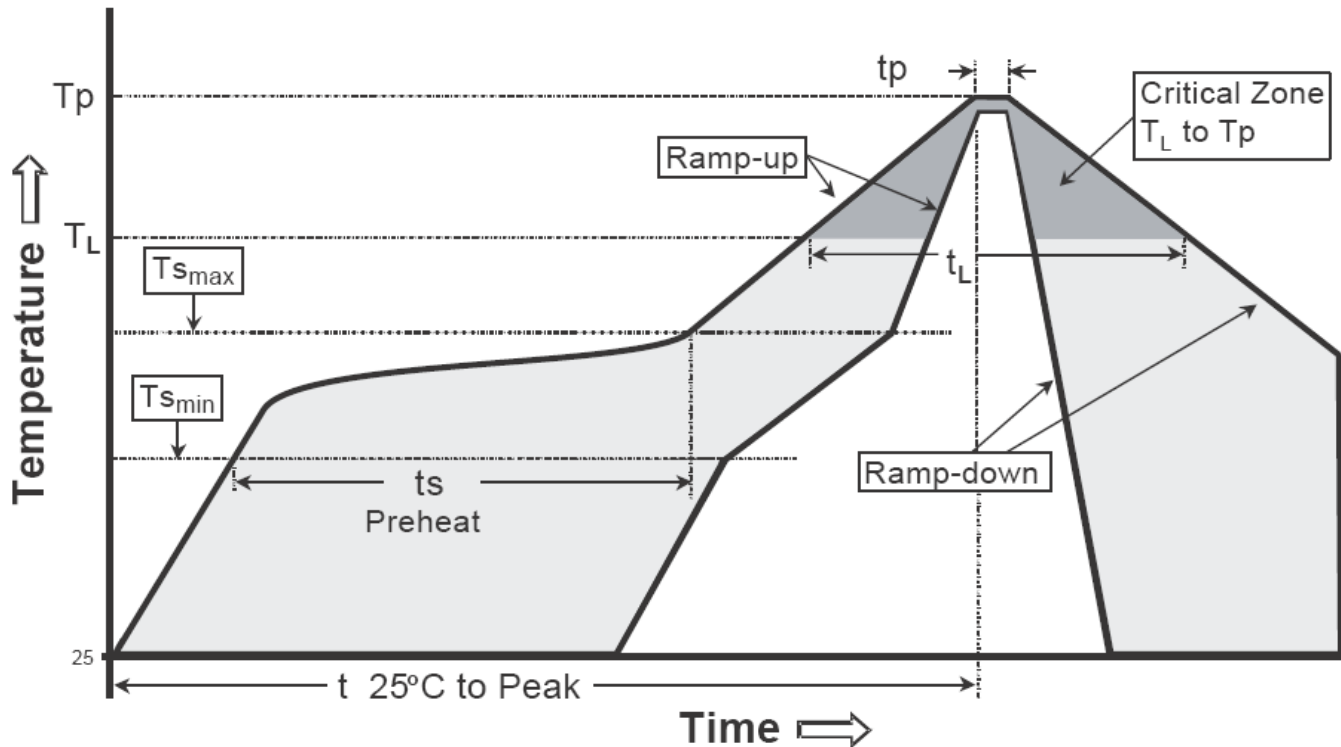

Profile feature	Sn-Pb eutectic Assembly	Pb-free Assembly
Average ramp-up rate (Tsmax to Tp)	3°C/second max.	3°C/second max.
Preheat		
-Temperature Min(Ts min)	100°C	150°C
-Temperature Max(Ts max)	150°C	200°C
-Time(ts min to ts max)	60-120 seconds	60-180 seconds
Time maintained above:		
-Temperature (Tl)	183°C	217°C
- Time (tl)	60-150 seconds	60-150 seconds
Peak Temperature(TP)	240 +0/-5 °C	260 +0/-5 °C
Time within 5°C of actual peak temperature(tp)	10-30 seconds	20-40 seconds
Ramp down rate	6°C/second max.	6°C/second max.
Time 25 °C to peak temperature	6 minutes max.	8 minutes max.

Note : 1. All temperatures refer to topside of the package, measured on the package body surface.
 2. For devices mounted on FR-4 PCB of 1.6mm or equivalent grade PCB. If other grade PCB is used, care should be taken to match the coefficients of thermal expansion between components and PCB. If they are not matched well, the solder joints may crack or the bodies of the parts may crack or shatter as the assembly cools.

DFN5x6 Dimension

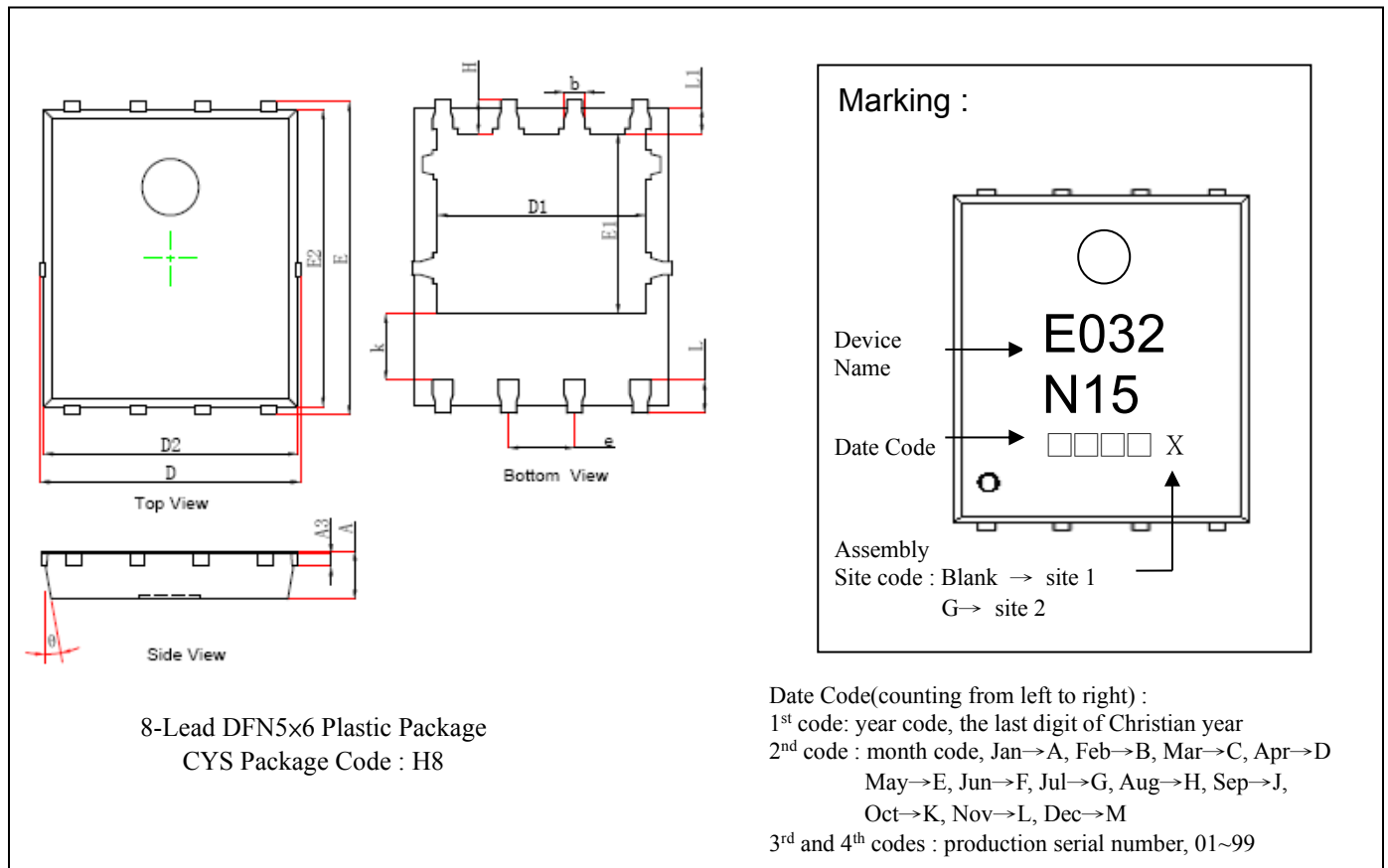

8-Lead DFN5x6 Plastic Package
 CYS Package Code : H8

Marking :

Device Name → E032
 N15
 Date Code → □□□□ X
 Assembly Site code : Blank → site 1
 G → site 2

Date Code(counting from left to right) :
 1st code: year code, the last digit of Christian year
 2nd code : month code, Jan→A, Feb→B, Mar→C, Apr→D
 May→E, Jun→F, Jul→G, Aug→H, Sep→J,
 Oct→K, Nov→L, Dec→M
 3rd and 4th codes : production serial number, 01~99

DIM	Millimeters		Inches		DIM	Millimeters		Inches	
	Min.	Max.	Min.	Max.		Min.	Max.	Min.	Max.
A	0.900	1.100	0.035	0.043	k	1.100	-	0.043	-
A3	0.200	0.300	0.008	0.012	b	0.330	0.510	0.013	0.020
D	4.944	5.096	0.195	0.201	e	1.270	TYP.	0.050	TYP.
E	5.900	6.126	0.232	0.241	L	0.510	0.711	0.020	0.028
D1	3.670	4.110	0.144	0.162	L1	0.310	0.576	0.012	0.023
E1	3.375	3.780	0.133	0.149	H	0.410	0.726	0.016	0.029
D2	4.800	5.000	0.189	0.197	θ	8°	12°	8°	12°
E2	5.674	5.826	0.223	0.229					

Notes: 1.Controlling dimension: millimeters.
 2.Maximum lead thickness includes lead finish thickness, and minimum lead thickness is the minimum thickness of base material.
 3.If there is any question with packing specification or packing method, please contact your local CYStek sales office.

Material:

- Lead: Pure tin plated.
- Mold Compound: Epoxy resin family, flammability solid burning class: UL94V-0.

Important Notice:

- All rights are reserved. Reproduction in whole or in part is prohibited without the prior written approval of CYStek.
- CYStek reserves the right to make changes to its products without notice.
- CYStek **semiconductor products are not warranted to be suitable for use in Life-Support Applications, or systems.**
- CYStek assumes no liability for any consequence of customer product design, infringement of patents, or application assistance.