

**N-Channel Enhancement Mode Power MOSFET**

# MTE013N10BRJ3

**Features**

- Low On Resistance
- Low Gate Charge
- Fast Switching Characteristic

$BV_{DSS}$	100V
$I_D@V_{GS}=10V, T_C=25^\circ C$	37A
$I_D@V_{GS}=10V, T_A=25^\circ C$	10A
$R_{DS(ON)}@V_{GS}=10V, I_D=10A$	12.5mΩ

**Equivalent Circuit**

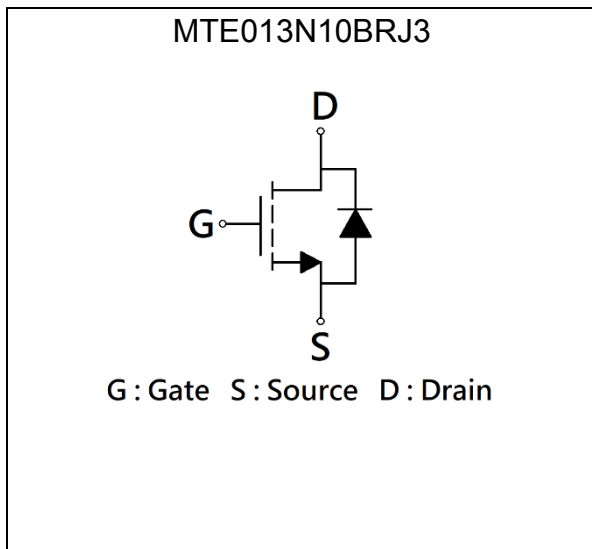

**Outline**

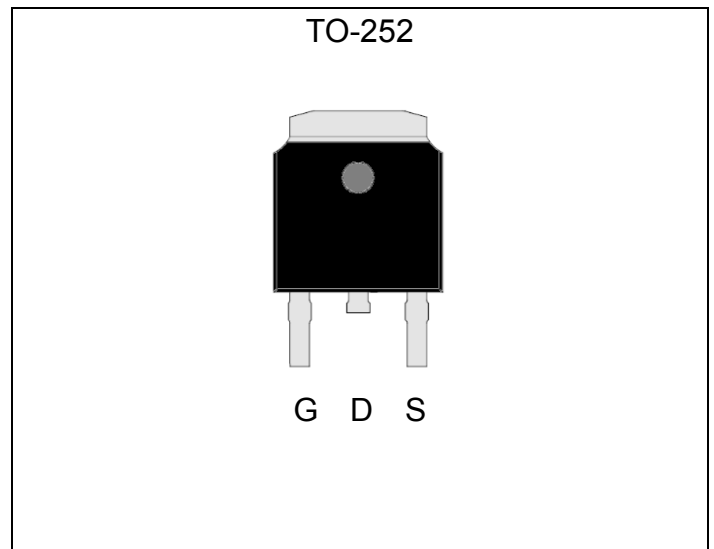

**Ordering Information**

Device	Package	Shipping
MTE013N10BRJ3-0-T3-G	TO-252 (Pb-free lead plating and halogen-free package)	2500 pcs / Tape & Reel

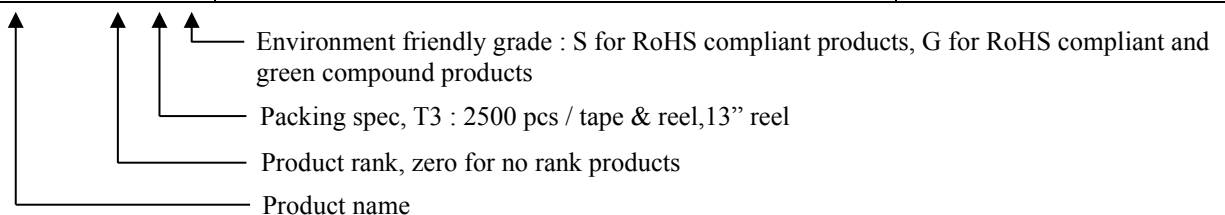

**Absolute Maximum Ratings (TA=25°C)**

Parameter	Symbol	Limits	Unit	
Drain-Source Voltage	V <sub>DS</sub>	100	V	
Gate-Source Voltage	V <sub>GS</sub>	±20		
Continuous Drain Current @ V <sub>GS</sub> =10V, T <sub>C</sub> =25°C	I <sub>D</sub>	37	A	
Continuous Drain Current @ V <sub>GS</sub> =10V, T <sub>C</sub> =100°C		23		
Continuous Drain Current @ V <sub>GS</sub> =10V, T <sub>A</sub> =25°C		10		
Continuous Drain Current @ V <sub>GS</sub> =10V, T <sub>A</sub> =70°C		8		
Pulsed Drain Current	I <sub>DM</sub>	148		
Continuous Body Diode Forward Current @ T <sub>C</sub> =25°C	I <sub>S</sub>	30		
Avalanche Current @ L=0.1mH	I <sub>AS</sub>	15		
Avalanche Energy @ L=0.5mH	E <sub>AS</sub>	36	mJ	
Total Power Dissipation	P <sub>D</sub>	T <sub>C</sub> =25°C	46	W
		T <sub>C</sub> =100°C	18	
		T <sub>A</sub> =25°C	3.6	
		T <sub>A</sub> =70°C	2.3	
Operating Junction and Storage Temperature Range	T <sub>J</sub> , T <sub>stg</sub>	-55~+150	°C	

**Thermal Data**

Parameter	Symbol	Steady State	Unit
Thermal Resistance, Junction-to-case	R <sub>θJC</sub>	2.7	°C/W
Thermal Resistance, Junction-to-ambient	R <sub>θJA</sub>	35	

Note:

- \*a. The power dissipation P<sub>D</sub> is based on T<sub>J(MAX)</sub>=150°C, using junction-to-case thermal resistance, and is more useful in setting the upper dissipation limit for cases where additional heatsinking is used.
- \*b. The value of R<sub>θJA</sub> is measured with the device mounted on 1 in<sup>2</sup> FR-4 board with 2 oz. copper, in a still air environment with T<sub>A</sub>=25°C. The power dissipation P<sub>DSM</sub> is based on R<sub>θJA</sub> and the maximum allowed junction temperature of 150°C. The value in any given application depends on the user's specific board design.
- \*c. Repetitive rating, pulse width limited by junction temperature T<sub>J(MAX)</sub>=150°C. Ratings are based on low frequency and low duty cycles to keep initial T<sub>J</sub>=25°C.



**Electrical Characteristics (T<sub>A</sub>=25°C, unless otherwise specified)**

Symbol	Min.	Typ.	Max.	Unit	Test Conditions
<b>Static</b>					
BV <sub>DSS</sub>	100	-	-	V	V <sub>GS</sub> =0V, I <sub>D</sub> =250μA
V <sub>GS(th)</sub>	2	-	4		V <sub>DS</sub> =V <sub>GS</sub> , I <sub>D</sub> =250μA
G <sub>FS</sub>	-	14	-	S	V <sub>DS</sub> =5V, I <sub>D</sub> =10A
I <sub>GSS</sub>	-	-	±100	nA	V <sub>GS</sub> =±20V, V <sub>DS</sub> =0V
I <sub>DSS</sub>	-	-	1	μA	V <sub>DS</sub> =80V, V <sub>GS</sub> =0V
R <sub>DS(ON)</sub>	-	12.5	16	mΩ	V <sub>GS</sub> =10V, I <sub>D</sub> =10A
<b>Dynamic</b>					
C <sub>iSS</sub>	-	1280	-	pF	V <sub>DS</sub> =50V, V <sub>GS</sub> =0V, f=1MHz
C <sub>oSS</sub>	-	180	-		
C <sub>rSS</sub>	-	30	-		
R <sub>g</sub>	-	0.5	-	Ω	f=1MHz
Q <sub>g</sub> *1, 2	-	20	-	nC	V <sub>DS</sub> =50V, I <sub>D</sub> =10A, V <sub>GS</sub> =10V
Q <sub>gs</sub> *1, 2	-	7.4	-		
Q <sub>gd</sub> *1, 2	-	4.5	-		
t <sub>d(ON)</sub> *1, 2	-	17	-	ns	V <sub>DS</sub> =50V, I <sub>D</sub> =10A, V <sub>GS</sub> =10V, R <sub>GS</sub> =3Ω
t <sub>r</sub> *1, 2	-	16	-		
t <sub>d(OFF)</sub> *1, 2	-	25	-		
t <sub>f</sub> *1, 2	-	6.4	-		
<b>Source-Drain Diode</b>					
V <sub>SD</sub> *1	-	0.86	1.2	V	I <sub>S</sub> =10A, V <sub>GS</sub> =0V
t <sub>rr</sub>	-	34	-	ns	I <sub>F</sub> =10A, dI <sub>F</sub> /dt=100A/μs
Q <sub>rr</sub>	-	50	-	nC	

Note:

\*1. Pulse Test : Pulse Width ≤300μs, Duty Cycle≤2%

\*2. Independent of operating temperature



## Typical Characteristics

Typical Output Characteristics

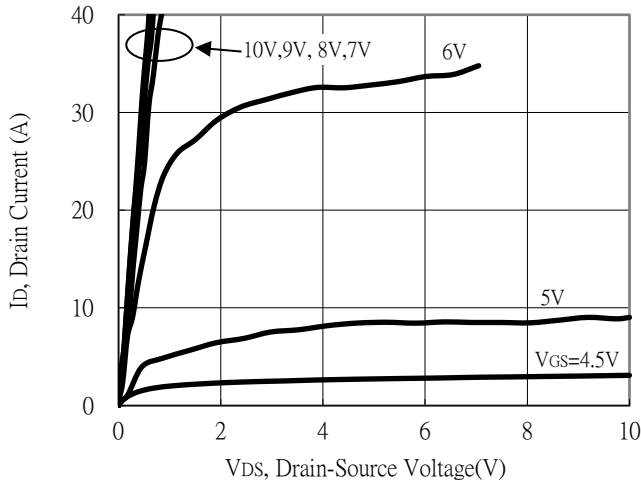

Breakdown Voltage vs Ambient Temperature

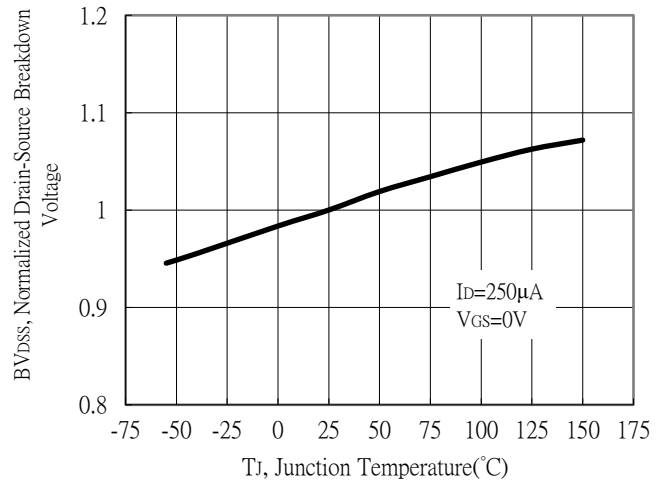

Static Drain-Source On-State resistance vs Drain Current

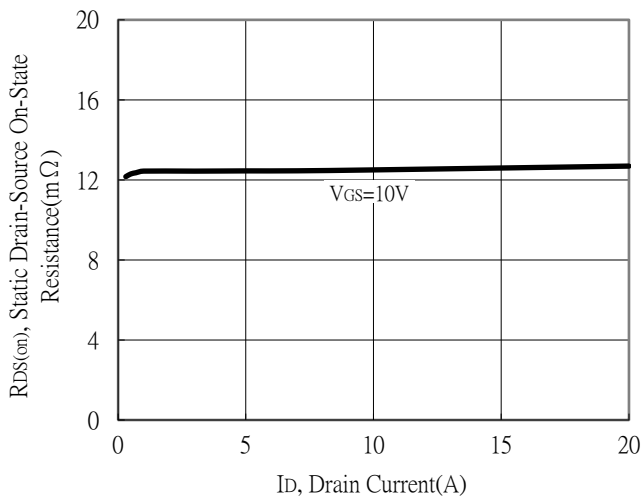

Body Diode Current vs Source-Drain Voltage

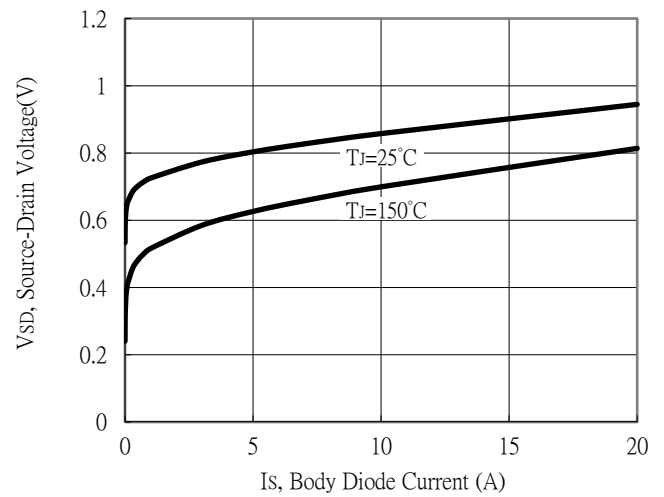

Static Drain-Source On-State Resistance vs Gate-Source Voltage

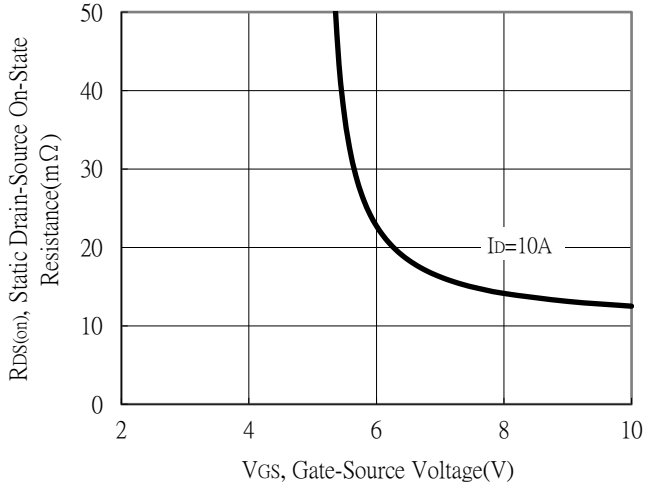

Drain-Source On-State Resistance vs Junction Temperature

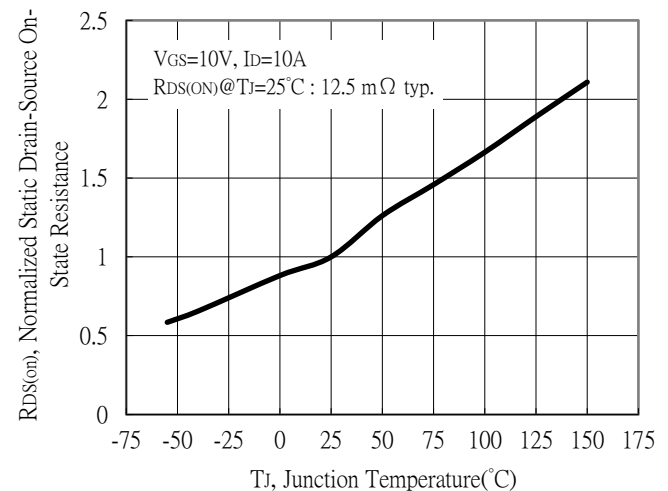



## Typical Characteristics (Cont.)

### Capacitance vs Drain-to-Source Voltage

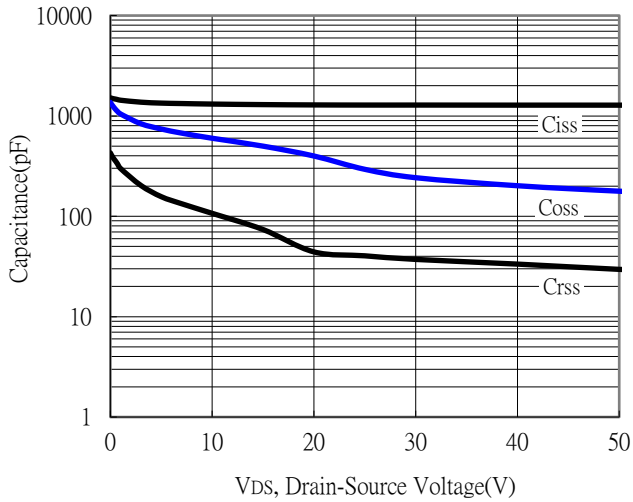

### Threshold Voltage vs Junction Temperature

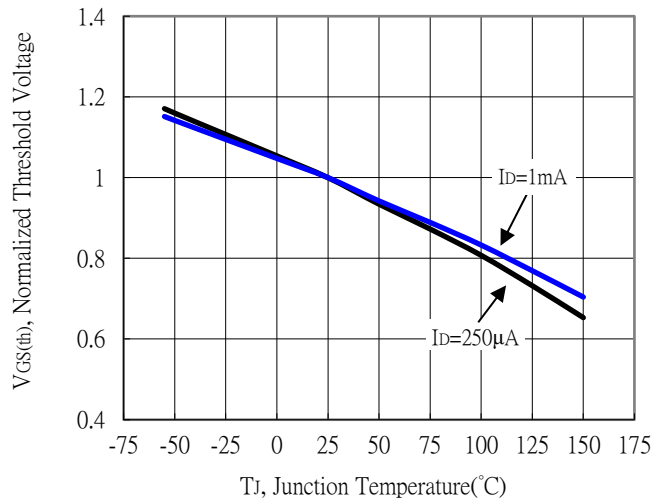

### Forward Transfer Admittance vs Drain Current

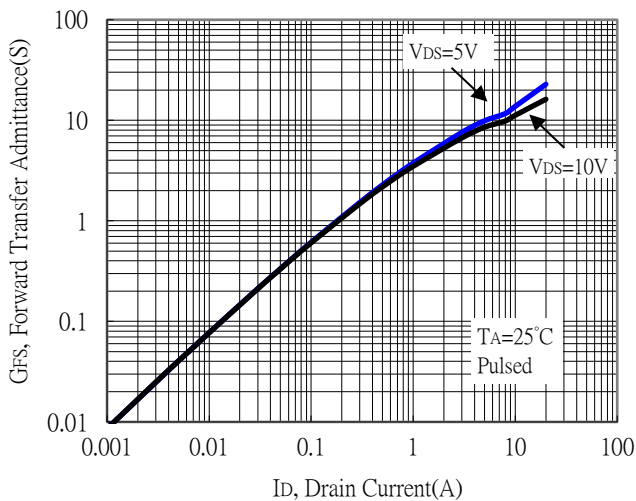

### Gate Charge Characteristics

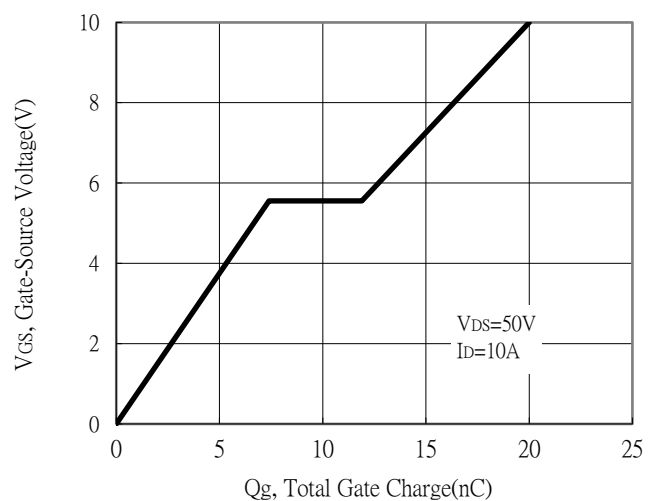

### Maximum Safe Operating Area

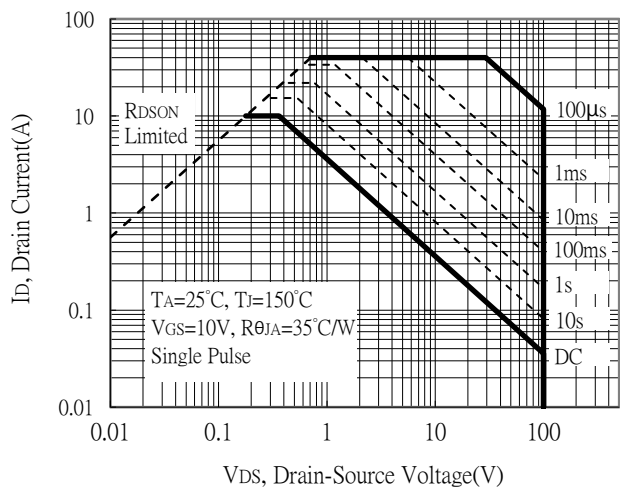

### Maximum Drain Current vs Junction Temperature

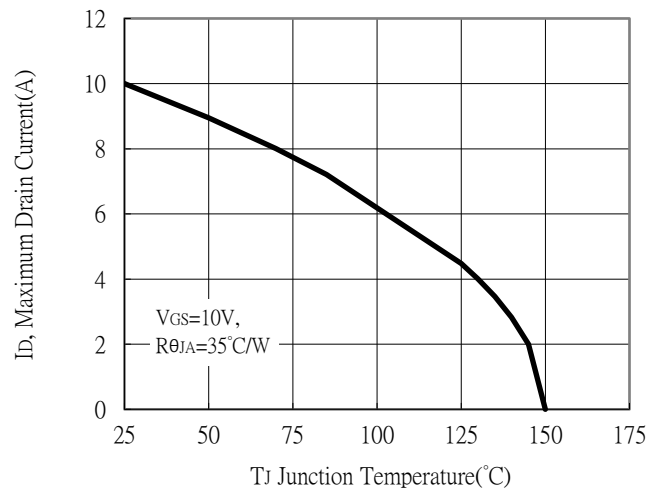

## Typical Characteristics (Cont.)

Single Pulse Power Rating, Junction to Ambient

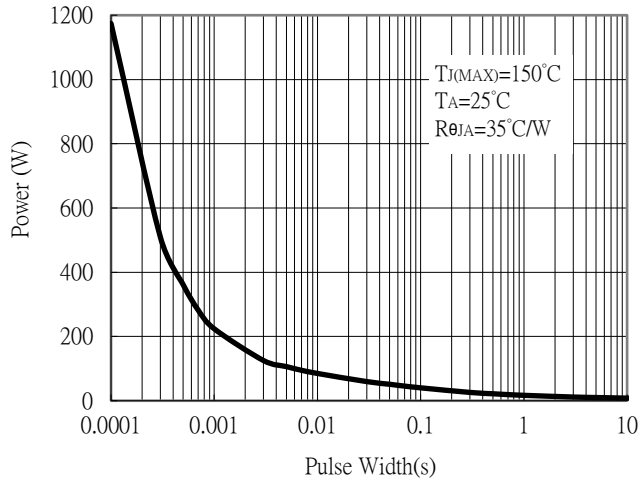

Transient Thermal Response Curves

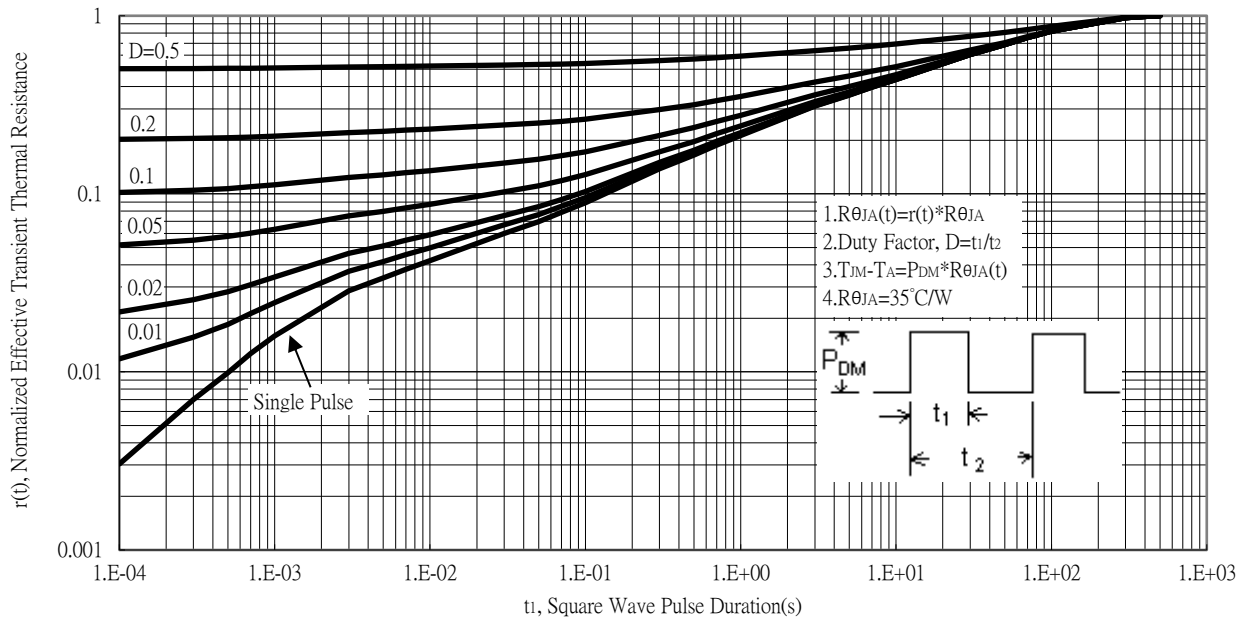

## Recommended soldering footprint

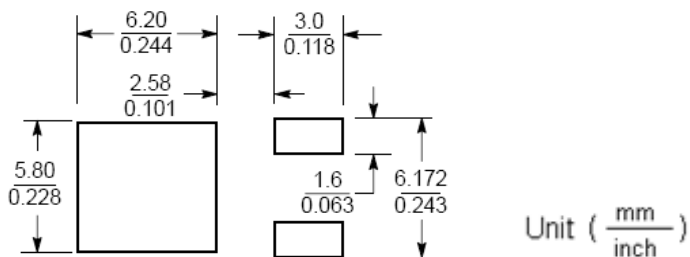

**Reel Dimension**

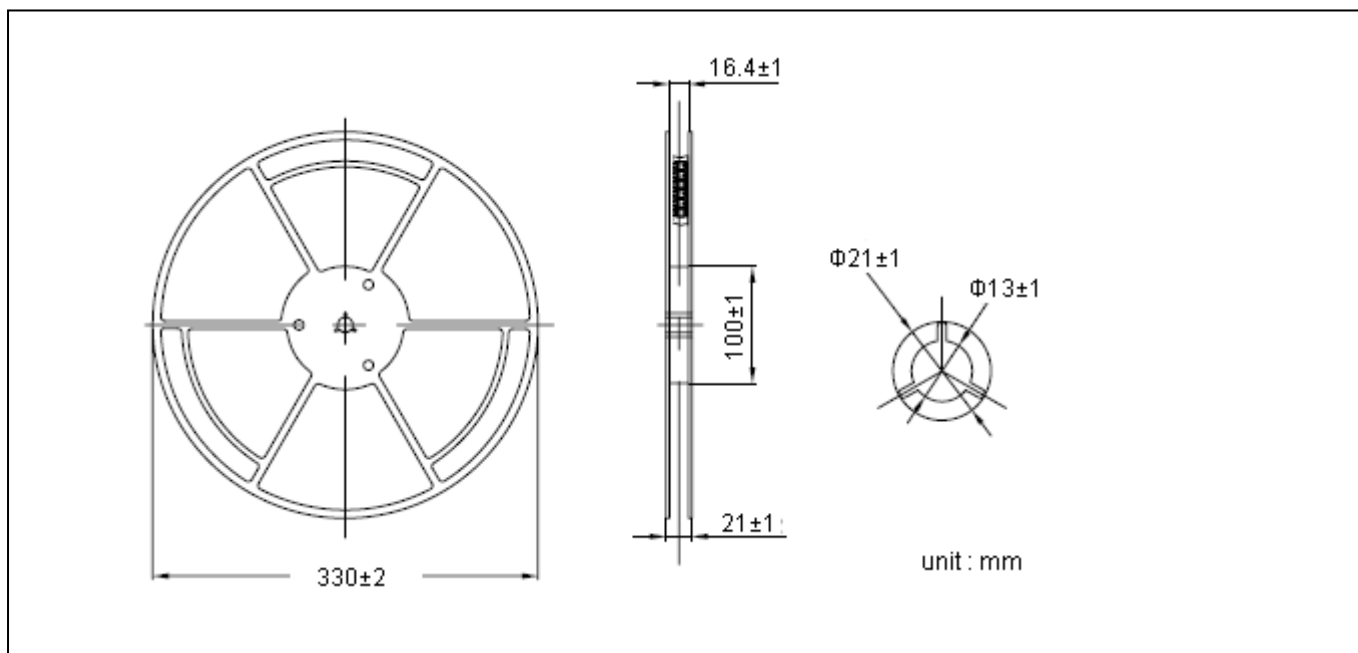

**Carrier Tape Dimension**

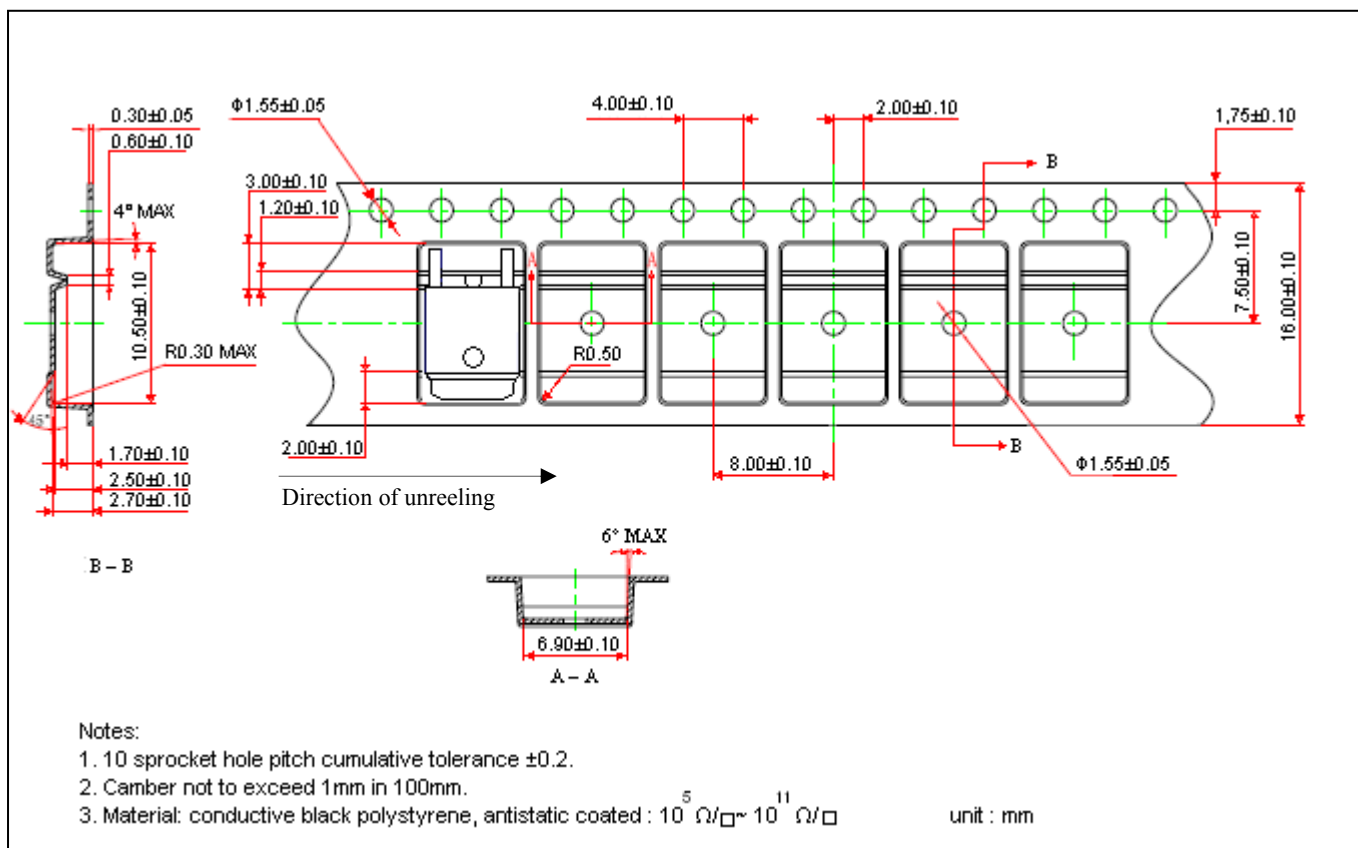

**Recommended wave soldering condition**

Product	Peak Temperature	Soldering Time
Pb-free devices	260 +0/-5 °C	5 +1/-1 seconds

**Recommended temperature profile for IR reflow**

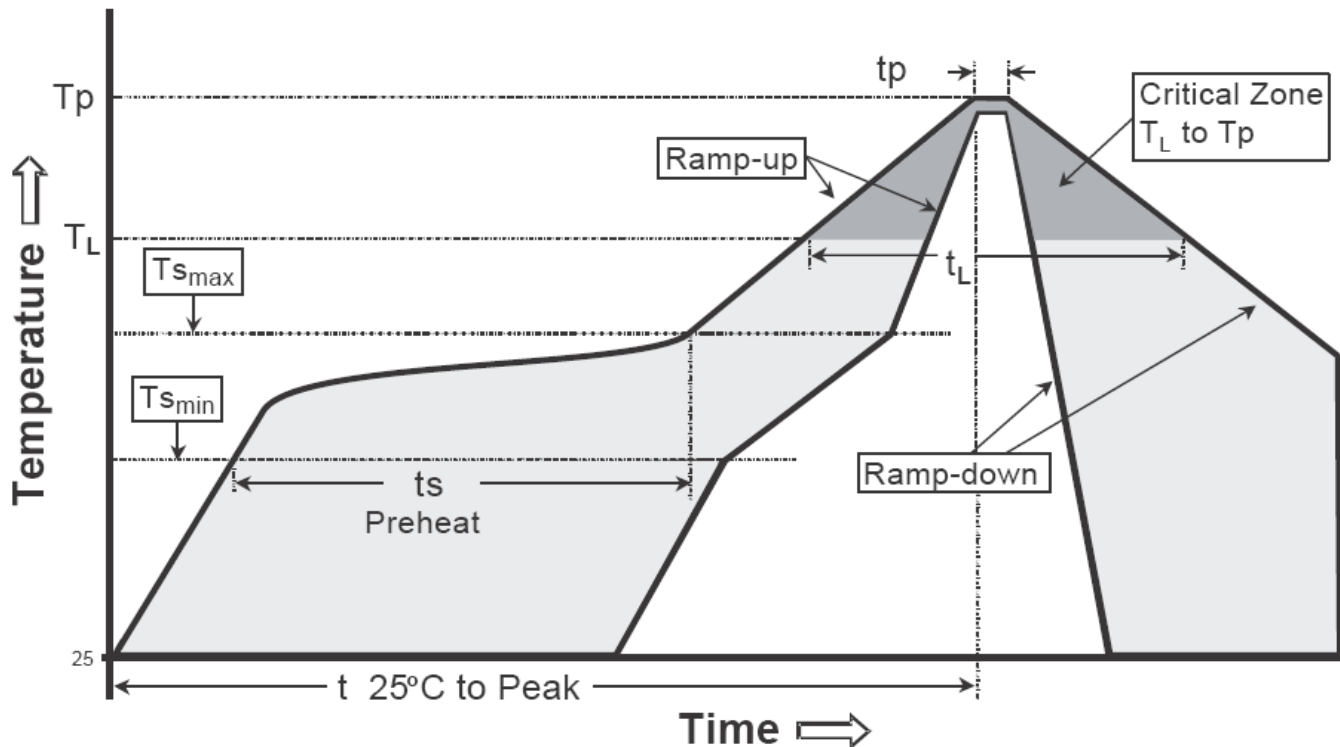

Profile feature	Sn-Pb eutectic Assembly	Pb-free Assembly
Average ramp-up rate (T <sub>smax</sub> to T <sub>p</sub> )	3°C/second max.	3°C/second max.
Preheat		
-Temperature Min(T <sub>s min</sub> )	100°C	150°C
-Temperature Max(T <sub>s max</sub> )	150°C	200°C
-Time(t <sub>s min</sub> to t <sub>s max</sub> )	60-120 seconds	60-180 seconds
Time maintained above:		
-Temperature (T <sub>L</sub> )	183°C	217°C
- Time (t <sub>L</sub> )	60-150 seconds	60-150 seconds
Peak Temperature(T <sub>P</sub> )	240 +0/-5 °C	260 +0/-5 °C
Time within 5°C of actual peak temperature(tp)	10-30 seconds	20-40 seconds
Ramp down rate	6°C/second max.	6°C/second max.
Time 25 °C to peak temperature	6 minutes max.	8 minutes max.

Note : All temperatures refer to topside of the package, measured on the package body surface.



**TO-252 Dimension**

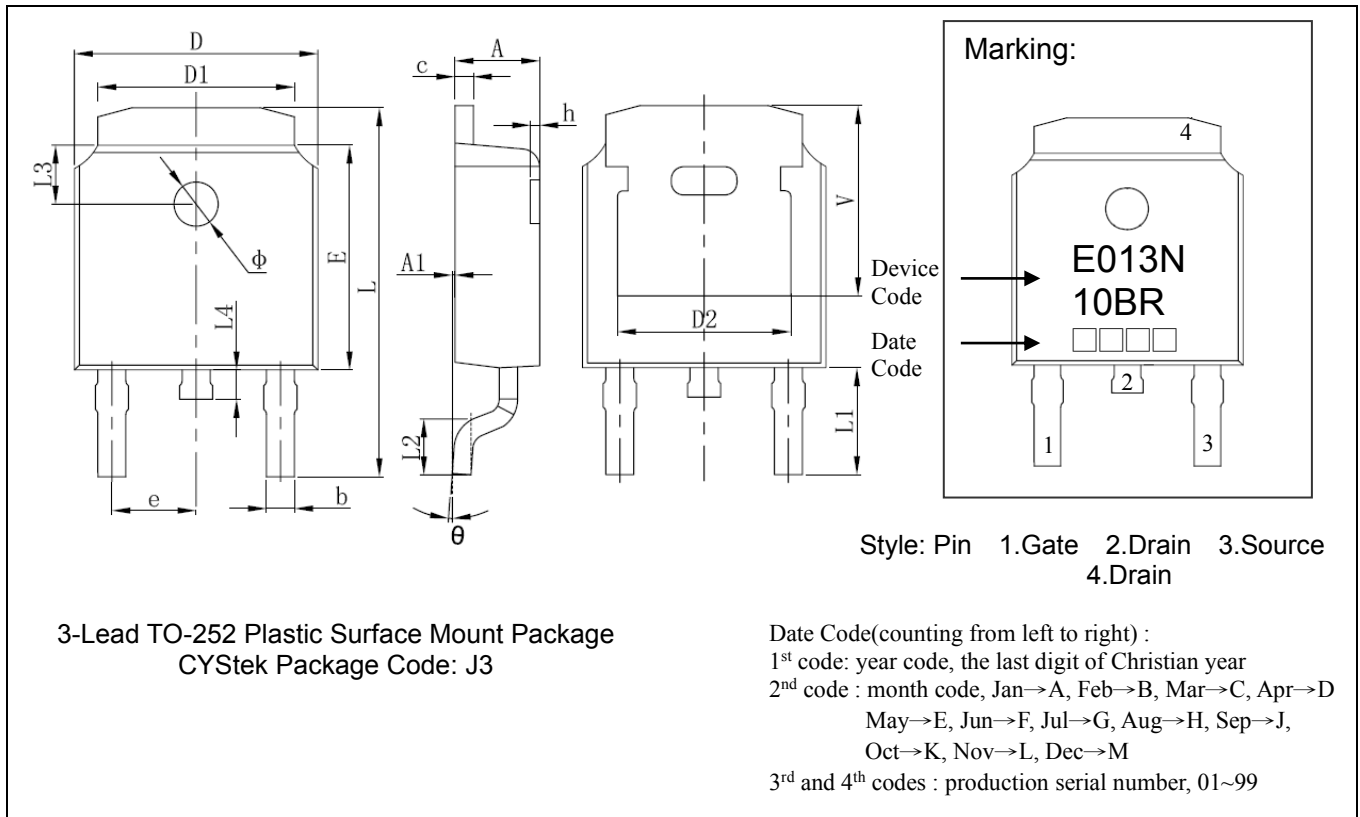

**3-Lead TO-252 Plastic Surface Mount Package**  
 CYStek Package Code: J3

Style: Pin 1.Gate 2.Drain 3.Source 4.Drain

Date Code(counting from left to right) :  
 1<sup>st</sup> code: year code, the last digit of Christian year  
 2<sup>nd</sup> code : month code, Jan→A, Feb→B, Mar→C, Apr→D  
 May→E, Jun→F, Jul→G, Aug→H, Sep→J,  
 Oct→K, Nov→L, Dec→M  
 3<sup>rd</sup> and 4<sup>th</sup> codes : production serial number, 01~99

DIM	Inches		Millimeters		DIM	Inches		Millimeters	
	Min.	Max.	Min.	Max.		Min.	Max.	Min.	Max.
A	0.087	0.094	2.200	2.400	L	0.382	0.406	9.712	10.312
A1	0.000	0.005	0.000	0.127	L1	0.114	REF	2.900	REF
b	0.025	0.030	0.635	0.770	L2	0.055	0.067	1.400	1.700
c	0.018	0.023	0.460	0.580	L3	0.063	REF	1.600	REF
D	0.256	0.264	6.500	6.700	L4	0.024	0.039	0.600	1.000
D1	0.201	0.215	5.100	5.460	Φ	0.043	0.051	1.100	1.300
D2	0.190	REF	4.830	REF	θ	0°	8°	0°	8°
E	0.236	0.244	6.000	6.200	h	0.000	0.012	0.000	0.300
e	0.086	0.094	2.186	2.386	v	0.207	REF	5.250	REF

Notes: 1.Controlling dimension: millimeters.  
 2.Maximum lead thickness includes lead finish thickness, and minimum lead thickness is the minimum thickness of base material.  
 3.If there is any question with packing specification or packing method, please contact your local CYStek sales office.

**Material:**

- Lead : Pure tin plated.
- Mold Compound: Epoxy resin family, flammability solid burning class: UL94V-0.

**Important Notice:**

- All rights are reserved. Reproduction in whole or in part is prohibited without the prior written approval of CYStek.
- CYStek reserves the right to make changes to its products without notice.
- CYStek **semiconductor products are not warranted to be suitable for use in Life-Support Applications, or systems.**
- CYStek assumes no liability for any consequence of customer product design, infringement of patents, or application assistance.