

Dual P-CHANNEL MOSFET

MTDP2004S6R

BV_{DSS}	-20V
$I_D @ V_{GS} = -4.5V, T_A = 25^\circ C$	-500mA
$R_{DSON} @ V_{GS} = -4.5V, I_D = -430mA$	0.64 Ω (typ)
$R_{DSON} @ V_{GS} = 2.5V, I_D = -300mA$	1.1 Ω (typ)
$R_{DSON} @ V_{GS} = -1.8V, I_D = -10mA$	1.7 Ω (typ)

Features

- Low on-resistance
- High ESD capability
- High speed switching
- Low-voltage drive(-1.8V)
- Pb-free package

Equivalent Circuit

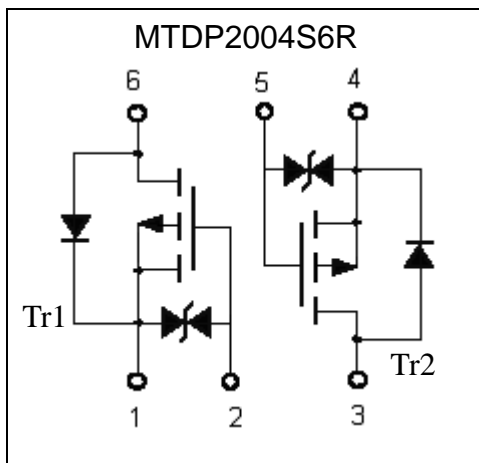

Outline

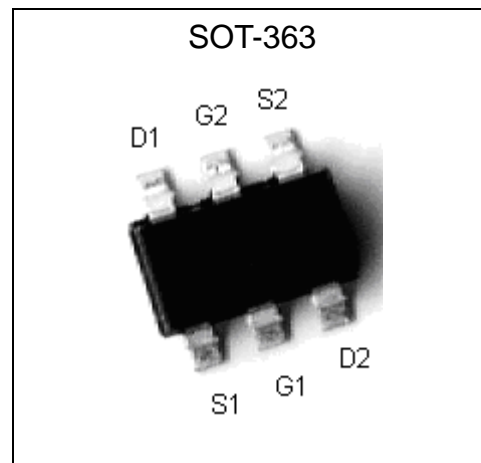

Ordering Information

Device	Package	Shipping
MTDP2004S6R-0-T1-G	SOT-363 (Pb-free lead plating and halogen-free package)	3000 pcs / Tape & Reel

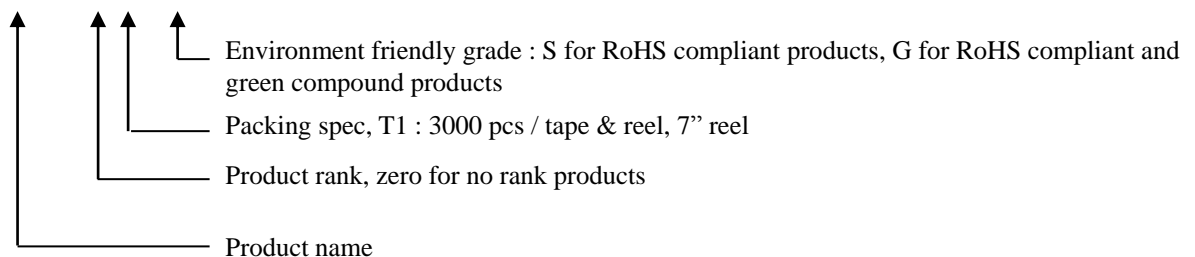



The following characteristics apply to both Tr1 and Tr2

Absolute Maximum Ratings (Ta=25°C)

Parameter		Symbol	Limits	Unit
Drain-Source Voltage		V _{DS}	-20	V
Gate-Source Voltage		V _{GS}	±8	
Continuous Drain Current @ T _A =25°C, V _{GS} =-4.5V (Note 3)		I _D	-500	mA
Continuous Drain Current @ T _A =85°C, V _{GS} =-4.5V (Note 3)			-360	
Pulsed Drain Current (Notes 1, 2)		I _{DM}	-1.5	A
Maximum Power Dissipation (Note 3)	T _A =25°C	P _D	300	mW
	T _A =85°C		160	
Operating Junction and Storage Temperature		T _j , T _{stg}	-55~+150	°C

- Note : 1. Pulse width limited by maximum junction temperature.
 2. Pulse width ≤ 300μs, duty cycle ≤ 2%.
 3. Surface mounted on 1 in² copper pad of FR-4 board, t ≤ 5s.

Thermal Performance

Parameter	Symbol	Limit	Unit
Thermal Resistance, Junction-to-Case	R _{th,jc}	285	°C/W
Thermal Resistance, Junction-to-Ambient(PCB mounted) (Note)	R _{th,ja}	417	

Note : Surface mounted on 1 in² copper pad of FR-4 board, t ≤ 5s.

Electrical Characteristics (Tj=25°C, unless otherwise noted)

Symbol	Min.	Typ.	Max.	Unit	Test Conditions
Static					
BV _{DSS}	-20	-	-	V	V _{GS} =0V, I _D =-250μA
V _{GS(th)}	-0.5	-0.8	-1.2		V _{DS} =V _{GS} , I _D =-250μA
I _{GSS}	-	-	±5	μA	V _{GS} =±8V, V _{DS} =0V
I _{DSS}	-	-	1		V _{DS} =20V, V _{GS} =0V
	-	-	10		V _{DS} =16V, V _{GS} =0V (T _j =70°C)
*R _{DS(ON)}	-	0.64	0.9	Ω	V _{GS} =-4.5V, I _D =-430mA
	-	1.1	1.4		V _{GS} =-2.5V, I _D =-300mA
	-	1.7	2.3		V _{GS} =-1.8V, I _D =-10mA
*G _{FS}	-	0.6	-	S	V _{DS} =-10V, I _D =-200mA
Dynamic					
C _{iss}	-	59	-	pF	V _{DS} =-10V, V _{GS} =0V, f=1MHz
C _{OSS}	-	21	-		
C _{rSS}	-	15	-		



$t_{d(ON)}$	-	5	-	ns	$V_{DS}=-6V, I_D=-500mA, V_{GS}=-4.5V, R_G=50\Omega$
t_r	-	6	-		
$t_{d(OFF)}$	-	42	-		
t_f	-	14	-		
Q_g	-	1.2	-	nC	$V_{DS}=-5V, I_D=-250mA, V_{GS}=-4.5V$
Q_{gs}	-	0.38	-		
Q_{gd}	-	0.23	-		
Source-Drain Diode					
$*V_{SD}$	-	-0.78	-1.2	V	$V_{GS}=0V, I_S=-115mA$

*Pulse Test : Pulse Width $\leq 300\mu s$, Duty Cycle $\leq 2\%$

Recommended Soldering Footprint

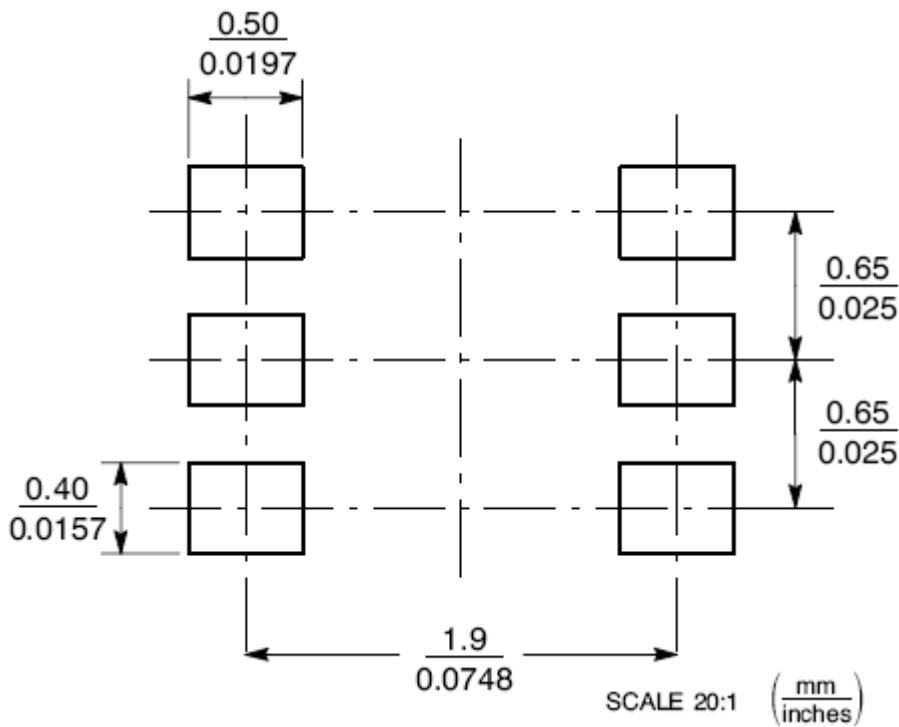

Typical Characteristics

Typical Output Characteristics

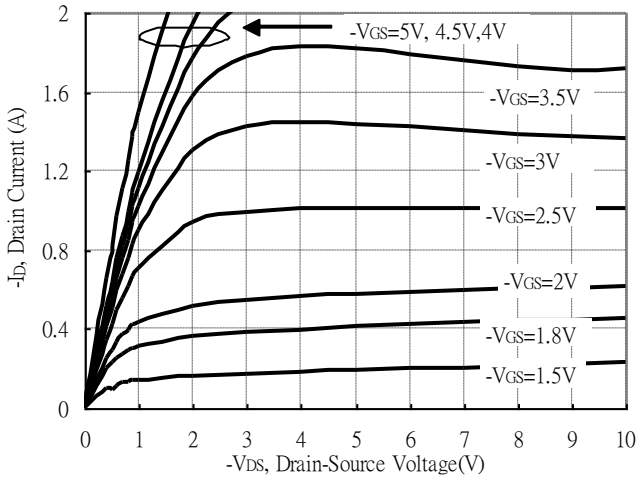

Brekdown Voltage vs Ambient Temperature

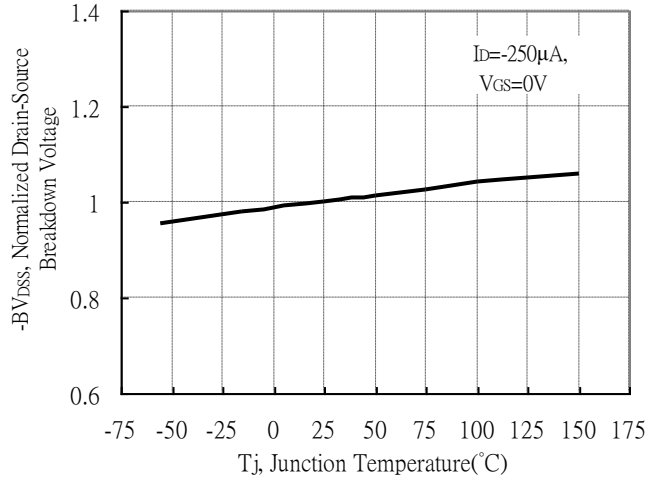

Static Drain-Source On-State resistance vs Drain Current

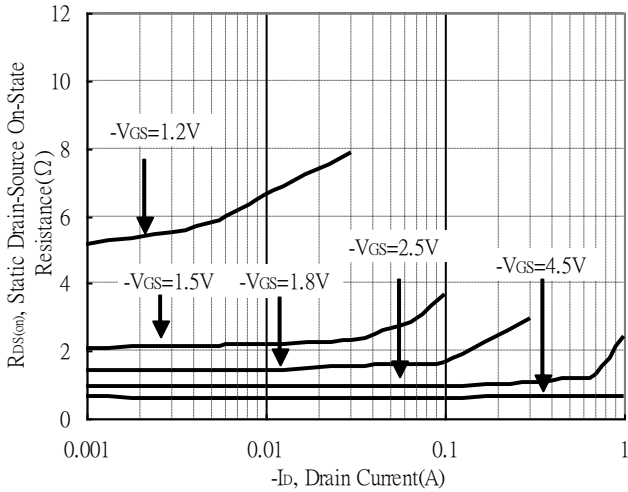

Reverse Drain Current vs Source-Drain Voltage

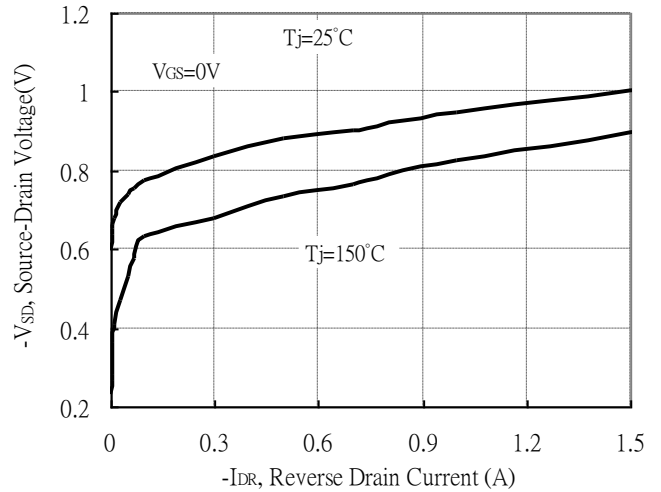

Static Drain-Source On-State Resistance vs Gate-Source Voltage

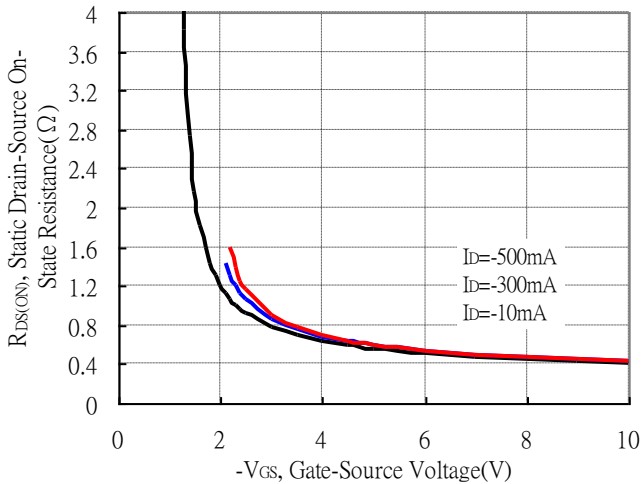

Drain-Source On-State Resistance vs Junction Temperature

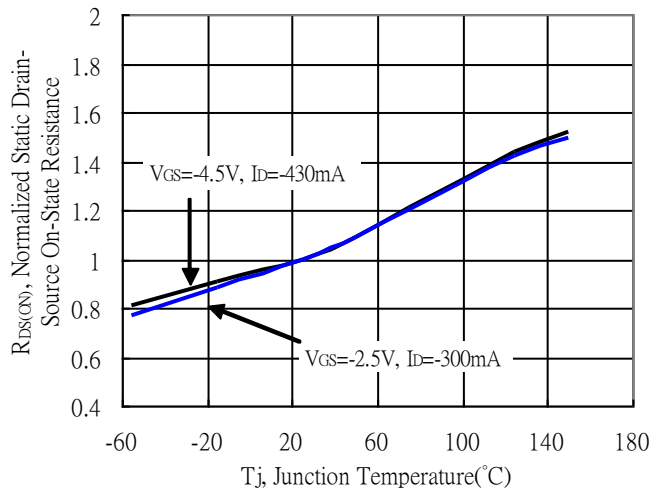

Typical Characteristics(Cont.)

Capacitance vs Drain-to-Source Voltage

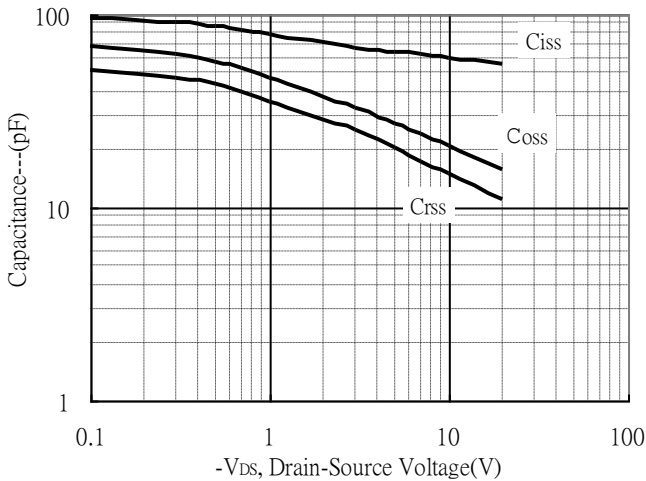

Threshold Voltage vs Junction Temperature

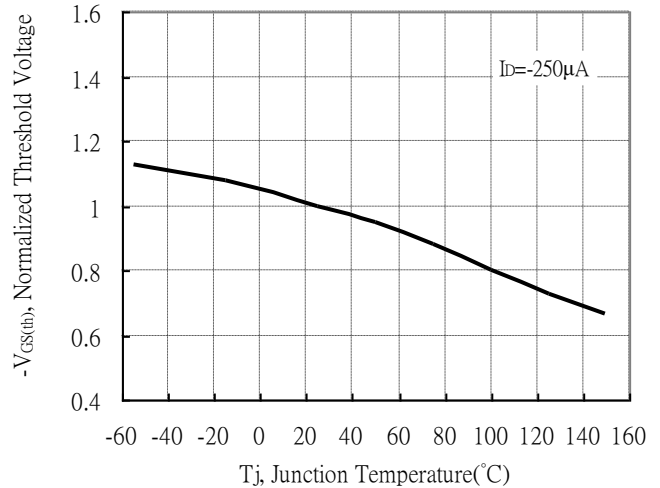

Single Pulse Power Rating, Junction to Ambient
 (Note on page 2)

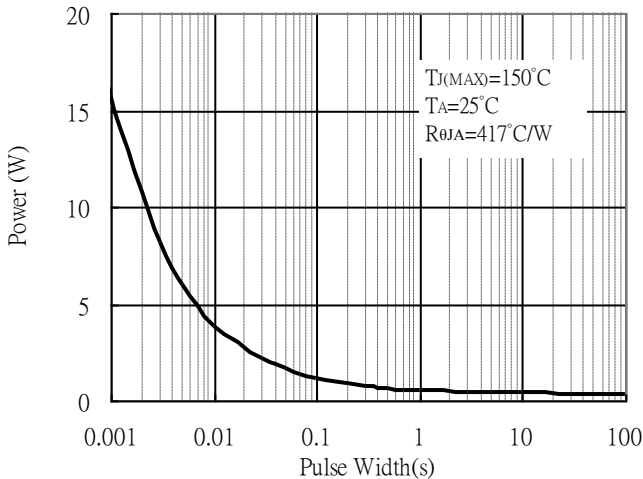

Gate Charge Characteristics

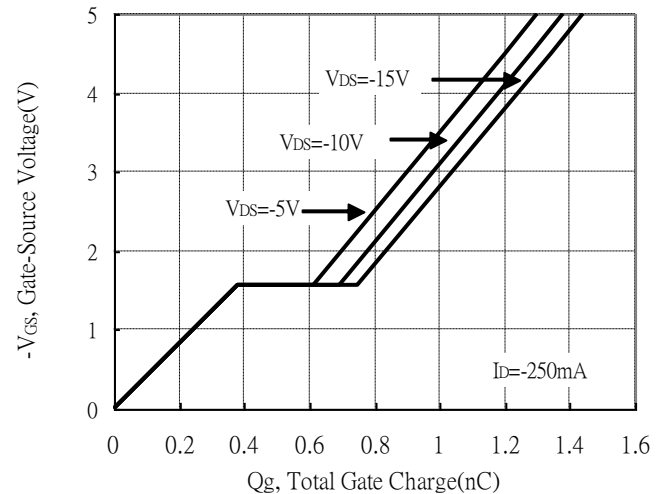

Maximum Safe Operating Area

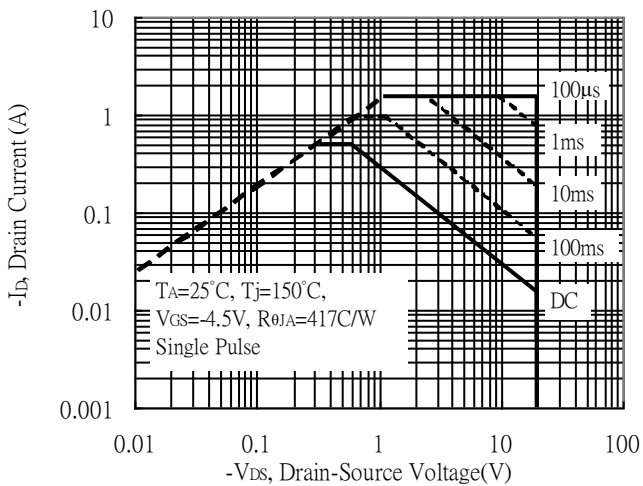

Maximum Drain Current vs Junction Temperature

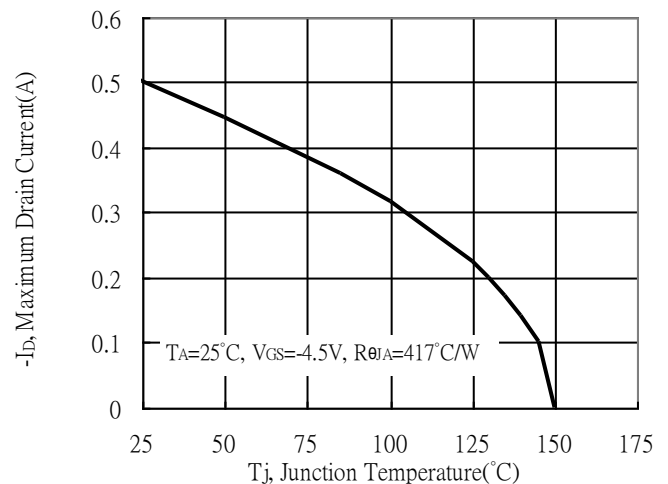

Typical Characteristics(Cont.)

Typical Transfer Characteristics

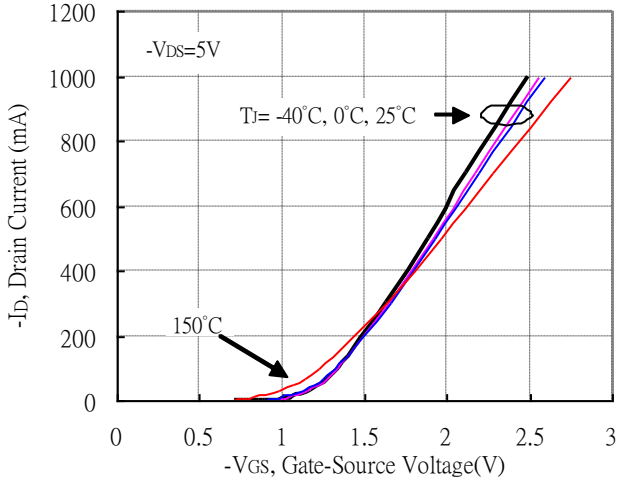

Power Derating Curve

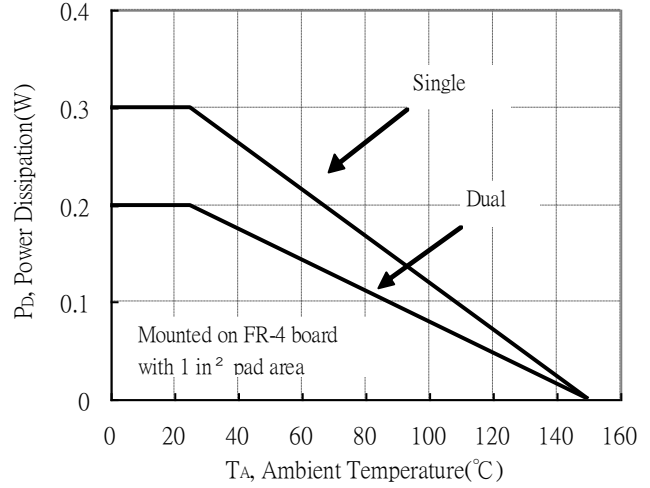

Forward Transfer Admittance vs Drain Current

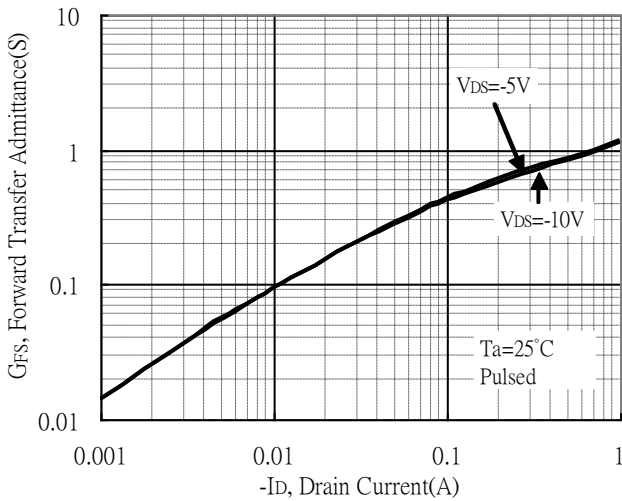

Transient Thermal Response Curves

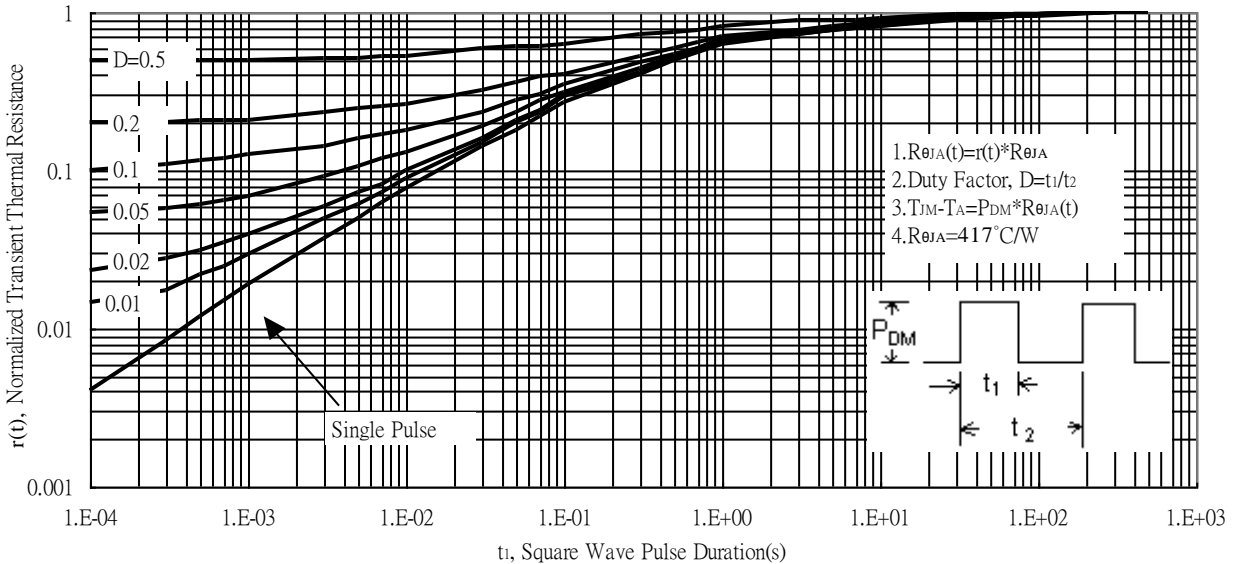

Reel Dimension

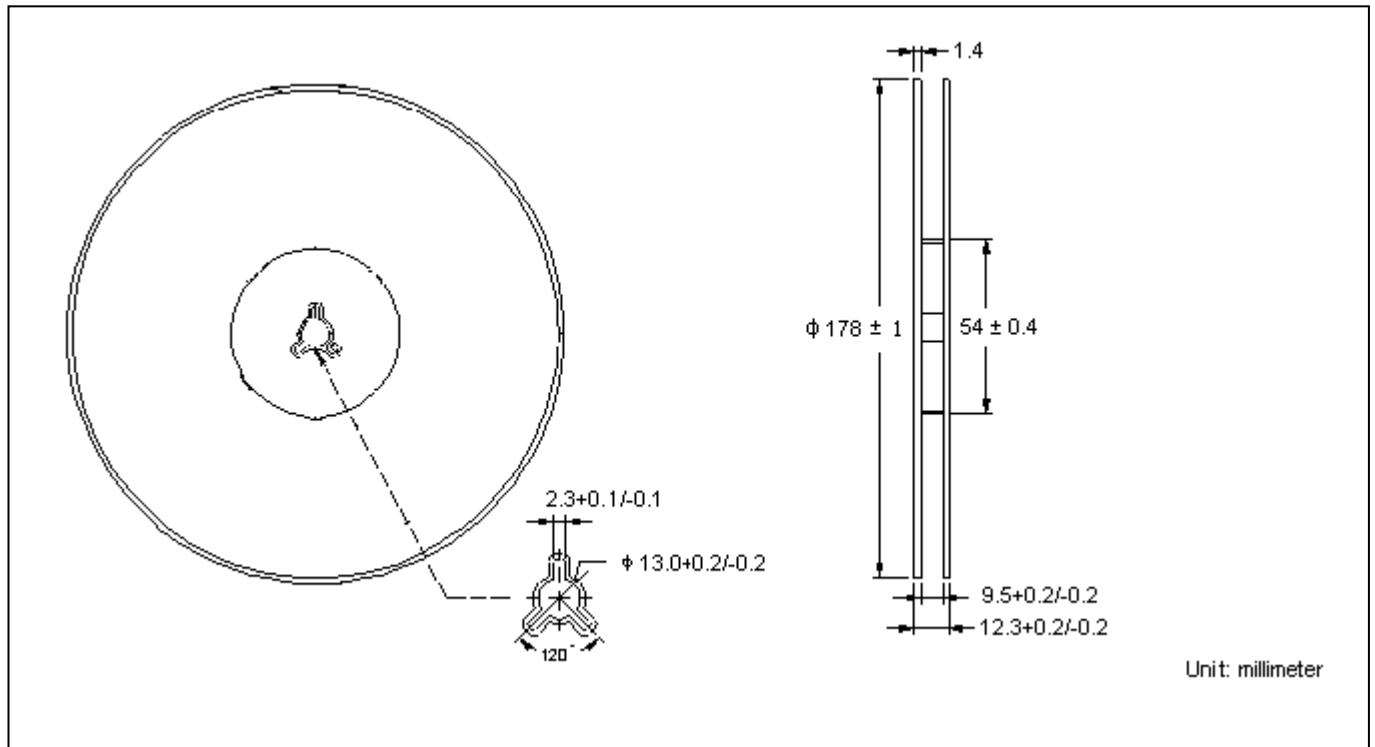

Carrier Tape Dimension

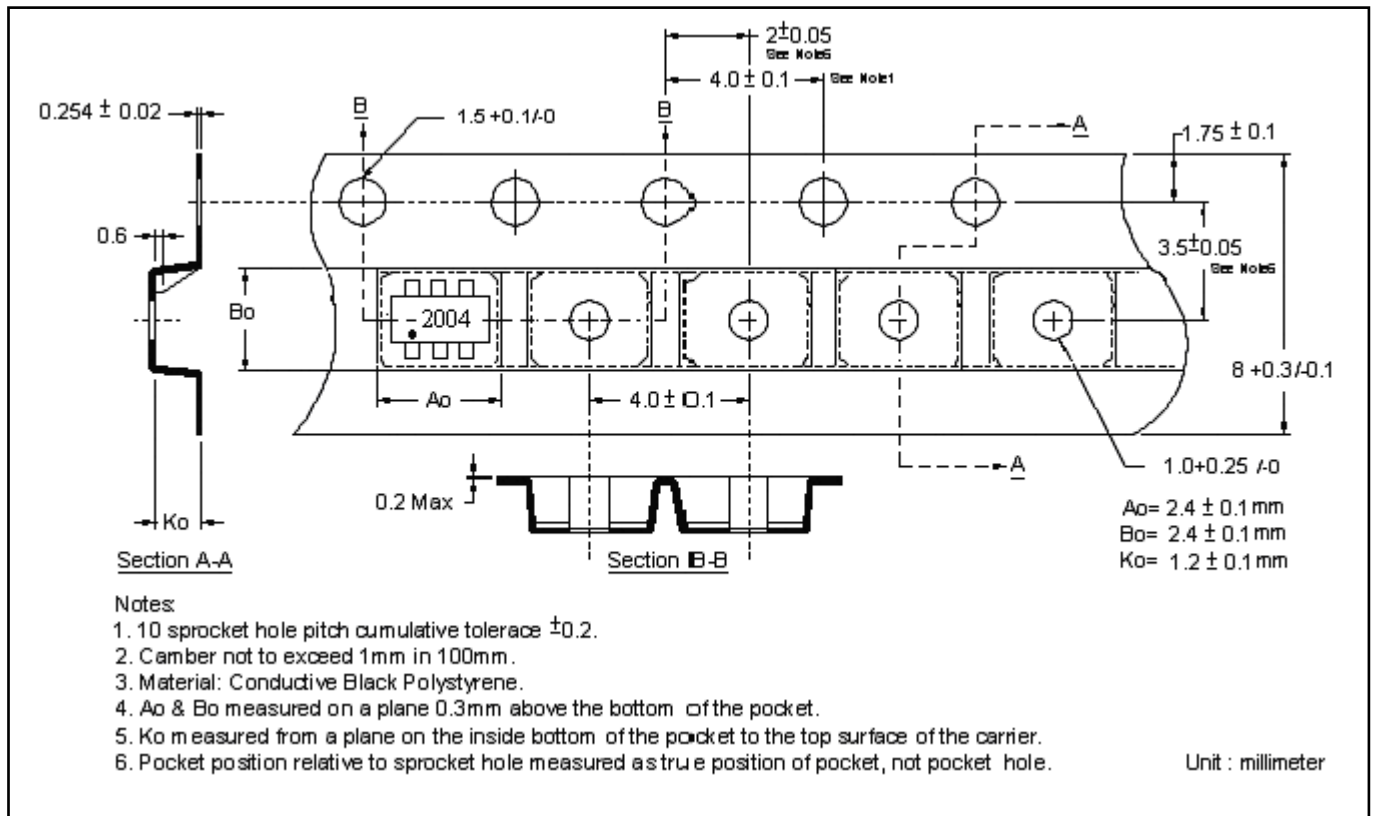

Recommended wave soldering condition

Product	Peak Temperature	Soldering Time
Pb-free devices	260 +0/-5 °C	5 +1/-1 seconds

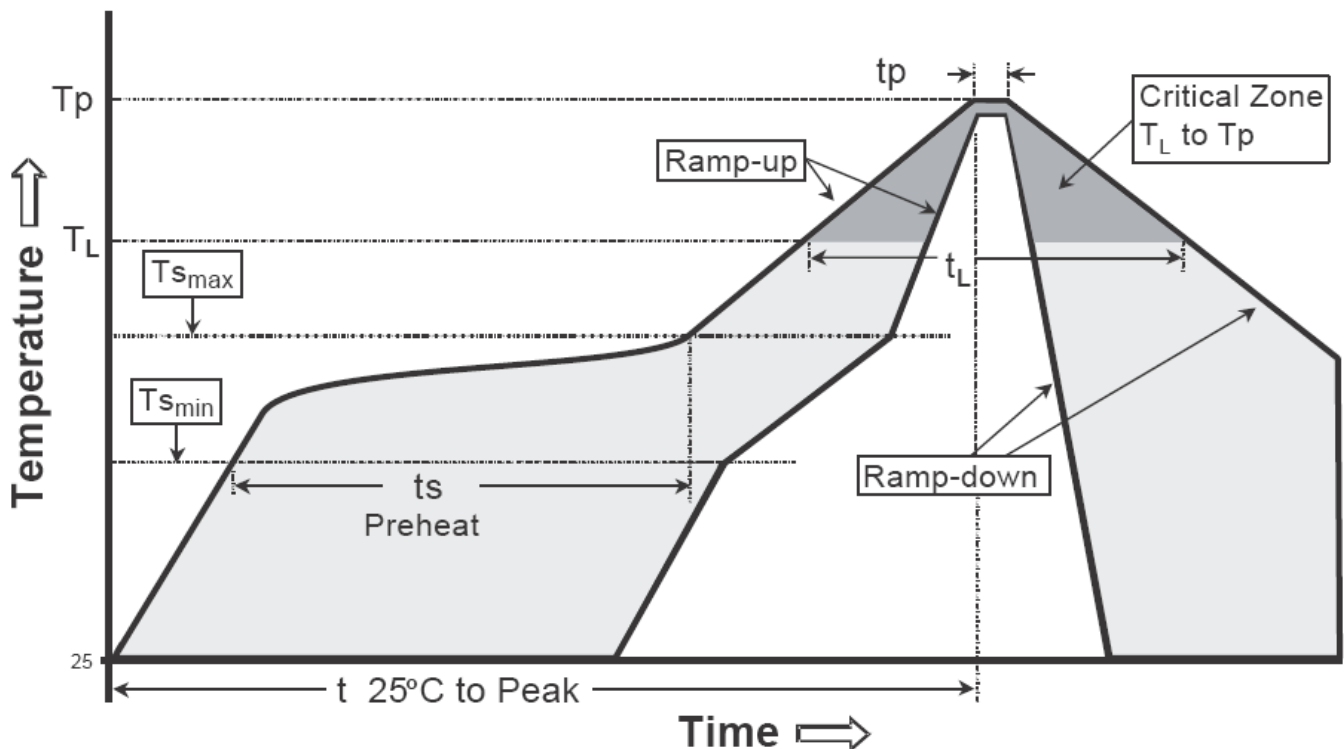
Recommended temperature profile for IR reflow

Profile feature	Sn-Pb eutectic Assembly	Pb-free Assembly
Average ramp-up rate (T _{smax} to T _p)	3°C/second max.	3°C/second max.
Preheat		
-Temperature Min(T _{s min})	100°C	150°C
-Temperature Max(T _{s max})	150°C	200°C
-Time(t _{s min} to t _{s max})	60-120 seconds	60-180 seconds
Time maintained above:		
-Temperature (T _L)	183°C	217°C
- Time (t _L)	60-150 seconds	60-150 seconds
Peak Temperature(T _p)	240 +0/-5 °C	260 +0/-5 °C
Time within 5°C of actual peak temperature(tp)	10-30 seconds	20-40 seconds
Ramp down rate	6°C/second max.	6°C/second max.
Time 25 °C to peak temperature	6 minutes max.	8 minutes max.

Note : All temperatures refer to topside of the package, measured on the package body surface.

SOT-363 Dimension

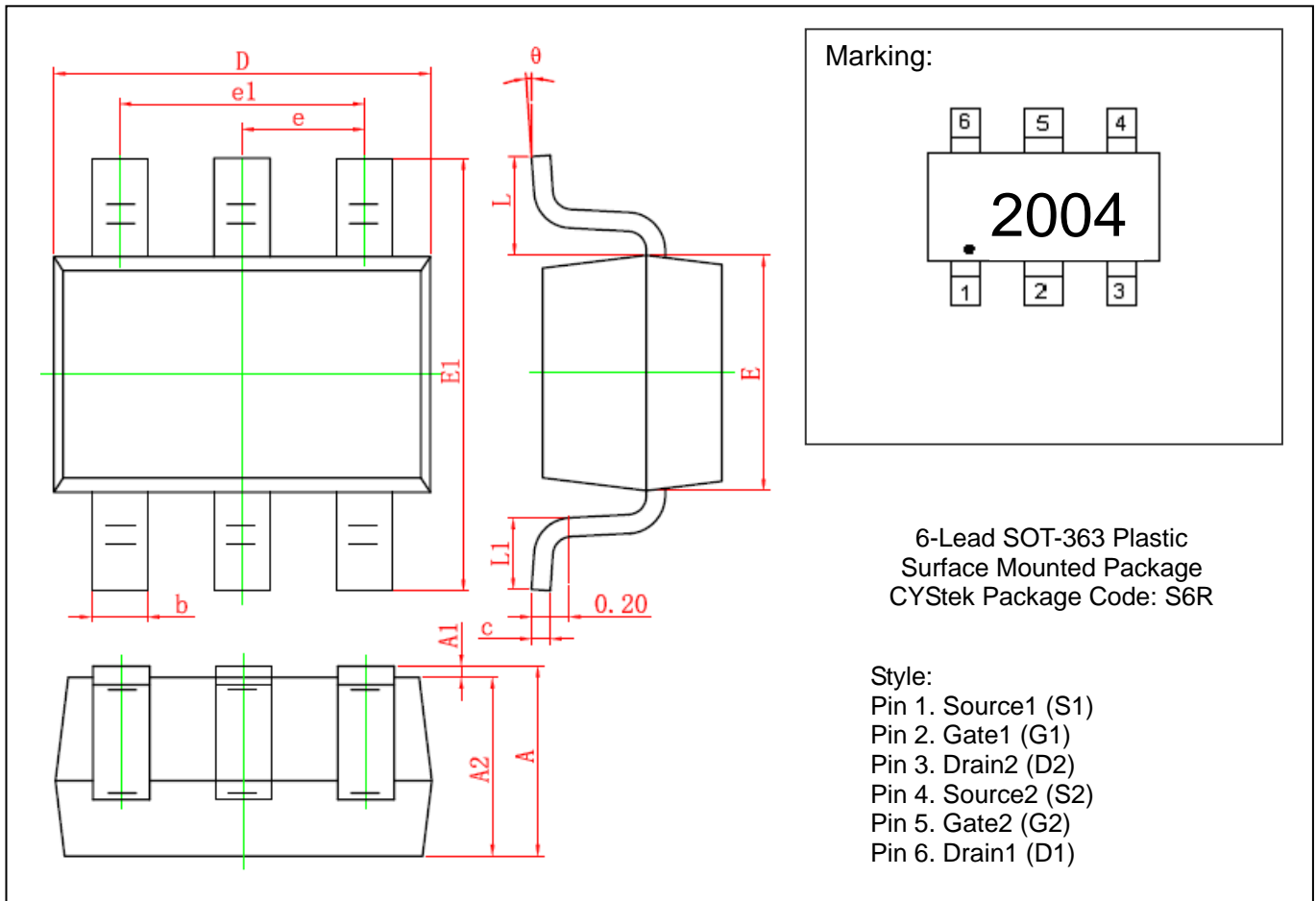

DIM	Millimeters		Inches		DIM	Millimeters		Inches	
	Min.	Max.	Min.	Max.		Min.	Max.	Min.	Max.
A	0.900	1.100	0.035	0.043	E1	2.150	2.450	0.085	0.096
A1	0.000	0.100	0.000	0.004	e	0.650	TYP	0.026	TYP
A2	0.900	1.000	0.035	0.039	e1	1.200	1.400	0.047	0.055
b	0.150	0.350	0.006	0.014	L	0.525	REF	0.021	REF
c	0.080	0.150	0.003	0.006	L1	0.260	0.460	0.010	0.018
D	2.000	2.200	0.079	0.087	θ	0°	8°	0°	8°
E	1.150	1.350	0.045	0.053					

Notes : 1.Controlling dimension : millimeters.
 2.Maximum lead thickness includes lead finish thickness, and minimum lead thickness is the minimum thickness of base material.
 3.If there is any question with packing specification or packing method, please contact your local CYStek sales office.

Material :

- Lead : Pure tin plated.
- Mold Compound : Epoxy resin family, flammability solid burning class:UL94V-0.

Important Notice:

- All rights are reserved. Reproduction in whole or in part is prohibited without the prior written approval of CYStek.
- CYStek reserves the right to make changes to its products without notice.
- CYStek **semiconductor products are not warranted to be suitable for use in Life-Support Applications, or systems.**
- CYStek assumes no liability for any consequence of customer product design, infringement of patents, or application assistance.