

N & P-Channel Enhancement Mode Power MOSFET

MTD120C10J4

	N-CH	P-CH
BV_{DSS}	100V	-100V
$I_D @ V_{GS}=10V(-10V), T_C=25^\circ C$	9.3A	-12A
$I_D @ V_{GS}=10V(-10V), T_A=25^\circ C$	2.0A	-2.5A
$R_{DS(on)(TYP)} @ V_{GS}=10V(-10V)$	122m Ω	91m Ω
$R_{DS(on)(TYP)} @ V_{GS}=4.5V(-4.5V)$	132m Ω	106m Ω

Features

- Low gate charge
- Simple drive requirement
- Pb-free lead plating and halogen-free package

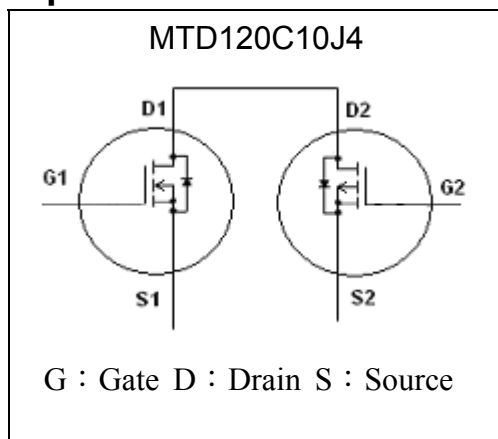
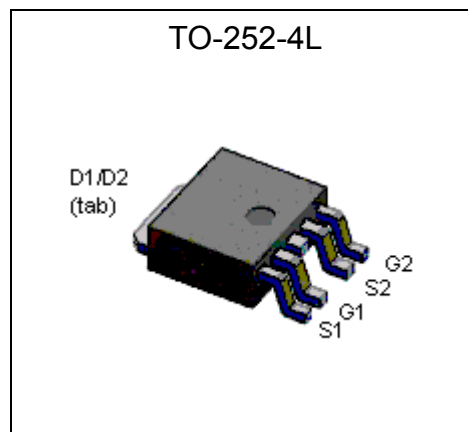
Equivalent Circuit

Outline

Absolute Maximum Ratings ($T_A=25^\circ C$, unless otherwise noted)

Parameter	Symbol	Limits		Unit
		N-channel	P-channel	
Drain-Source Voltage	V_{DS}	100	-100	V
Gate-Source Voltage	V_{GS}	± 20	± 20	
Continuous Drain Current @ $T_C=25^\circ C, V_{GS}=10V(-10V)$ (Note1)	I_D	9.3	-12.0	A
Continuous Drain Current @ $T_C=100^\circ C, V_{GS}=10V(-10V)$ (Note1)		6.6	-8.5	
Continuous Drain Current @ $T_A=25^\circ C, V_{GS}=10V(-10V)$ (Note2)	I_{DSM}	2.0	-2.5	
Continuous Drain Current @ $T_A=70^\circ C, V_{GS}=10V(-10V)$ (Note2)		1.7	-2.1	
Pulsed Drain Current *1 (Note3)	I_{DM}	20	-20	
Single Pulse Avalanche Current	I_{AS}	9	-30	
Avalanche Energy @ $L=0.1mH, I_D=I_{AS}, V_{DD}=50V(-50V)$	E_{AS}	4	58	mJ
Total Power Dissipation ($T_C=25^\circ C$) (Note1)	P_D	37.5		W
Total Power Dissipation ($T_C=100^\circ C$) (Note1)		18.7		
Total Power Dissipation ($T_A=25^\circ C$) (Note2)	P_{DSM}	2.4		
Total Power Dissipation ($T_A=70^\circ C$) (Note2)		1.7		
Operating Junction and Storage Temperature Range	T_j, T_{stg}	-55~+175		$^\circ C$

Note : *1. Pulse width limited by maximum junction temperature

 *2. Duty cycle $\leq 1\%$



Thermal Data

Parameter	Symbol	Value	Unit
Thermal Resistance, Junction-to-case, max	$R_{th,j-c}$	4	°C/W
Thermal Resistance, Junction-to-ambient, max (Note2)	$R_{th,j-a}$	62.5	
Thermal Resistance, Junction-to-ambient, max (Note4)		90	

- Note :
1. The power dissipation P_D is based on $T_{J(MAX)}=175^{\circ}C$, using junction-to-case thermal resistance, and is more useful in setting the upper dissipation limit for cases where additional heatsinking is used.
 2. The value of $R_{\theta JA}$ is measured with the device mounted on 1 in² FR-4 board with 2 oz. copper, in a still air environment with $T_A=25^{\circ}C$. The power dissipation P_{DSM} is based on $R_{\theta JA}$ and the maximum allowed junction temperature of $150^{\circ}C$. The value in any given application depends on the user's specific board design.
 3. Repetitive rating, pulse width limited by junction temperature $T_{J(MAX)}=175^{\circ}C$. Ratings are based on low frequency and low duty cycles to keep initial $T_J=25^{\circ}C$.
 4. When mounted on the minimum pad size recommended (PCB mount), $t_{\leq 10s}$.

N-CH Characteristics (Tc=25°C, unless otherwise specified)

Symbol	Min.	Typ.	Max.	Unit	Test Conditions
Static					
BV_{DSS}	100	-	-	V	$V_{GS}=0V, I_D=250\mu A$
$V_{GS(th)}$	1.2	-	2.4		$V_{DS}=V_{GS}, I_D=250\mu A$
$G_{FS} *1$	-	5.4	-	S	$V_{DS}=10V, I_D=2A$
I_{GSS}	-	-	± 100	nA	$V_{GS}=\pm 20V, V_{DS}=0V$
I_{DSS}	-	-	1	μA	$V_{DS}=90V, V_{GS}=0V$
	-	-	25		$V_{DS}=90V, V_{GS}=0V, T_J=125^{\circ}C$
$R_{DS(ON)} *1$	-	122	160	mΩ	$V_{GS}=10V, I_D=2A$
	-	132	175		$V_{GS}=4.5V, I_D=1.5A$
Dynamic					
$Q_g *1$	-	8.0	-	nC	$I_D=2A, V_{DS}=80V, V_{GS}=10V$
$Q_{gs} *1$	-	1.0	-		
$Q_{gd} *1$	-	2.3	-		
$t_{d(ON)} *1$	-	5.6	-	ns	$V_{DS}=50V, I_D=1A, V_{GS}=10V, R_G=6\Omega$
$t_r *1$	-	16.6	-		
$t_{d(OFF)} *1$	-	21.2	-		
$t_f *1$	-	16.4	-		
C_{iss}	-	281	-	pF	$V_{GS}=0V, V_{DS}=25V, f=1MHz$
C_{oss}	-	42	-		
C_{rss}	-	21	-		
Source-Drain Diode					
$I_S *1$	-	-	2.0	A	
$I_{SM} *2$	-	-	8.0		
$V_{SD} *1$	-	0.80	1.3	V	$I_S=2A, V_{GS}=0V$
$t_{rr} *1$	-	19.5	-	ns	$I_F=2A, V_{GS}=0V, dI_F/dt=100A/\mu s$
$Q_{rr} *1$	-	17.9	-	nC	

- Note :
- *1. Pulse Test : Pulse Width $\leq 300\mu s$, Duty Cycle $\leq 2\%$
 - *2. Pulse width limited by maximum junction temperature.



P-CH Characteristics (Tc=25°C, unless otherwise specified)

Symbol	Min.	Typ.	Max.	Unit	Test Conditions
Static					
BV _{DSS}	-100	-	-	V	V _{GS} =0V, I _D =-250μA
V _{GS(th)}	-1.2	-	-2.4		V _{DS} =V _{GS} , I _D =-250μA
G _{FS} *1	-	7.1	-	S	V _{DS} =-10V, I _D =-2A
I _{GSS}	-	-	±100	nA	V _{GS} =±20V, V _{DS} =0V
I _{DSS}	-	-	-1	μA	V _{DS} =-80V, V _{GS} =0V
	-	-	-25		V _{DS} =-80V, V _{GS} =0V, T _j =125°C
R _{DS(ON)} *1	-	91	120	mΩ	V _{GS} =-10V, I _D =-2A
	-	106	140		V _{GS} =-4.5V, I _D =-1.5A
Dynamic					
Q _g *1	-	27	-	nC	I _D =-2A, V _{DS} =-80V, V _{GS} =-10V
Q _{gs} *1	-	3.8	-		
Q _{gd} *1	-	6.3	-		
t _{d(ON)} *1	-	10.6	-	ns	V _{DS} =-50V, I _D =-1A, V _{GS} =-10V, R _G =6Ω
t _r *1	-	18.4	-		
t _{d(OFF)} *1	-	75.6	-		
t _f *1	-	65.2	-		
C _{iss}	-	1323	-	pF	V _{GS} =0V, V _{DS} =-25V, f=1MHz
C _{oss}	-	116	-		
C _{rss}	-	58	-		
Source-Drain Diode					
I _s *1	-	-	-2.3	A	
I _{SM} *2	-	-	-9.2		
V _{SD} *1	-	-0.75	-1.3	V	I _S =-2.0A, V _{GS} =0V
t _{rr} *1	-	22.6	-	ns	I _F =-2.0A, V _{GS} =0V, dI _F /dt=100A/μs
Q _{rr} *1	-	24.8	-	nC	

Note : *1.Pulse Test : Pulse Width ≤300μs, Duty Cycle≤2%
 *2.Pulse width limited by maximum junction temperature.

Ordering Information

Device	Package	Shipping
MTD120C10J4-0-T6-G	TO-252-4L (Pb-free lead plating and halogen-free package)	3000 pcs / Tape & Reel

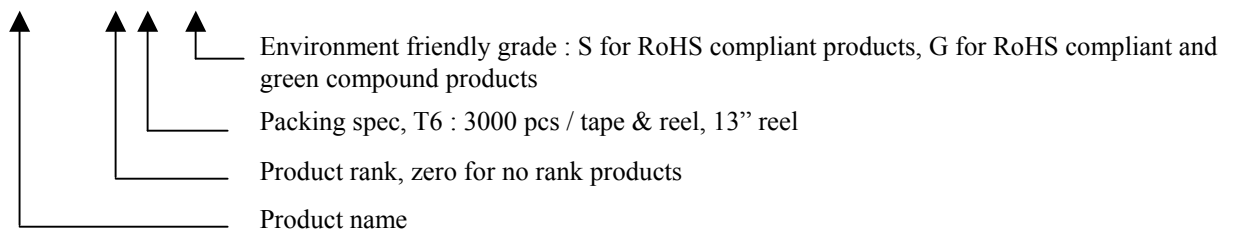



Q1, N-CH Typical Characteristics

Typical Output Characteristics

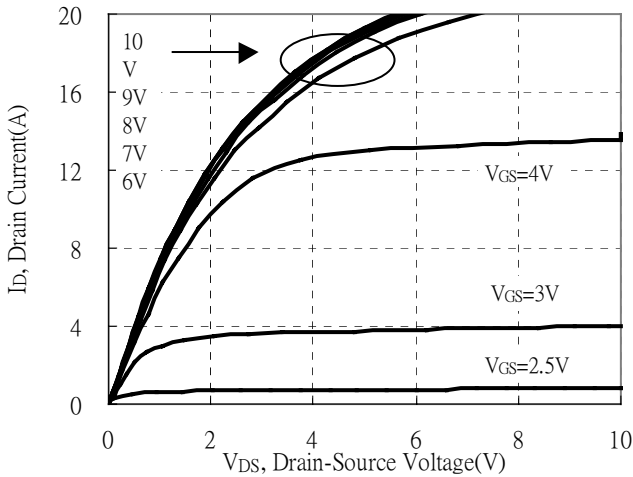

Brekdown Voltage vs Ambient Temperature

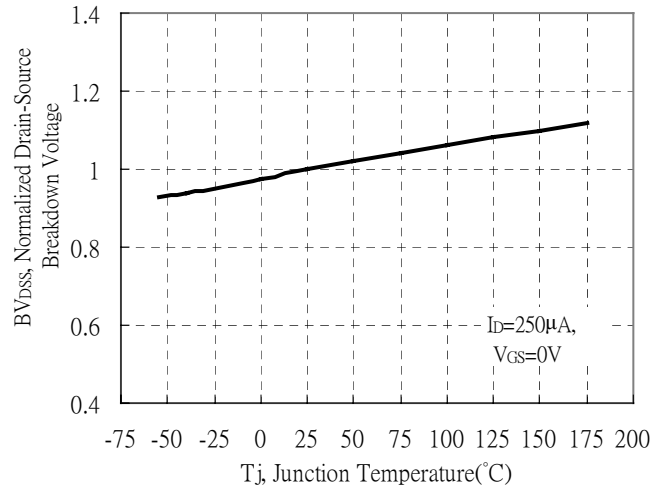

Static Drain-Source On-State resistance vs Drain Current

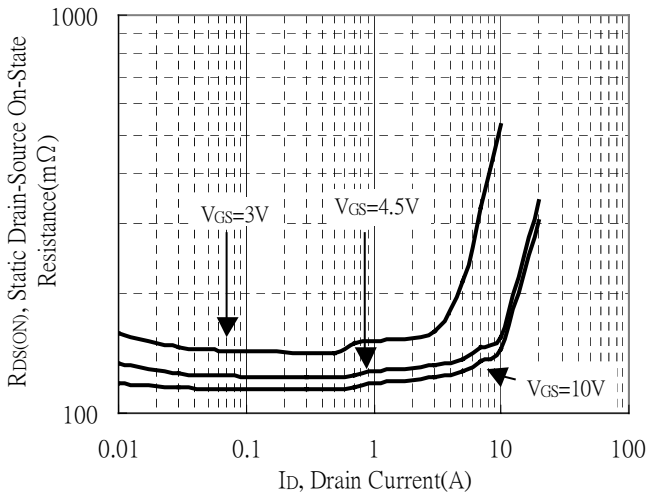

Reverse Drain Current vs Source-Drain Voltage

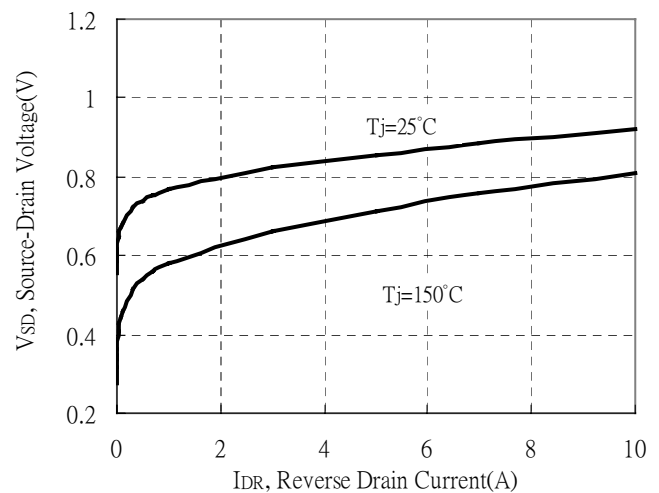

Static Drain-Source On-State Resistance vs Gate-Source Voltage

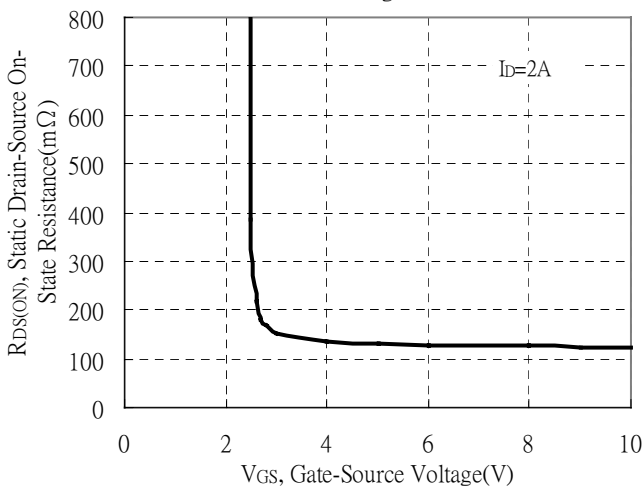

Drain-Source On-State Resistance vs Junction Temperature

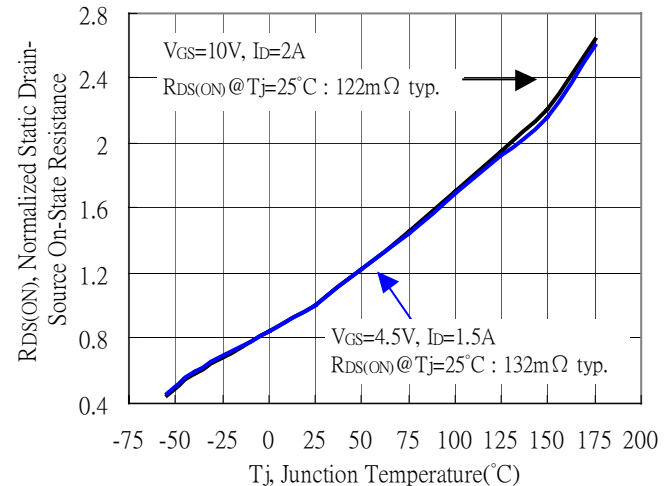



Q1, N-CH Typical Characteristics(Cont.)

Capacitance vs Drain-to-Source Voltage

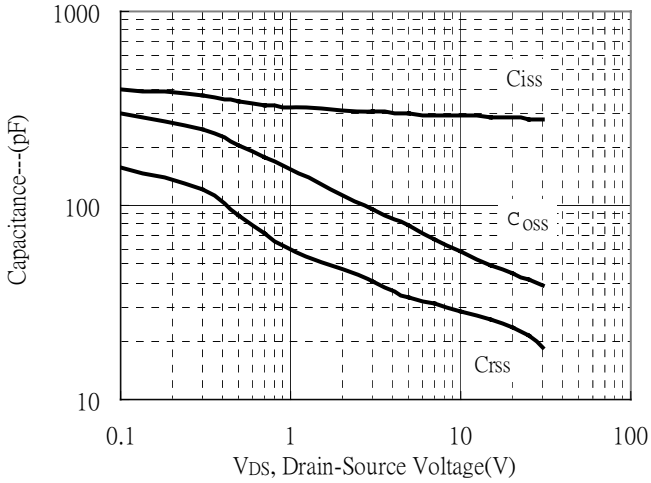

Threshold Voltage vs Junction Temperature

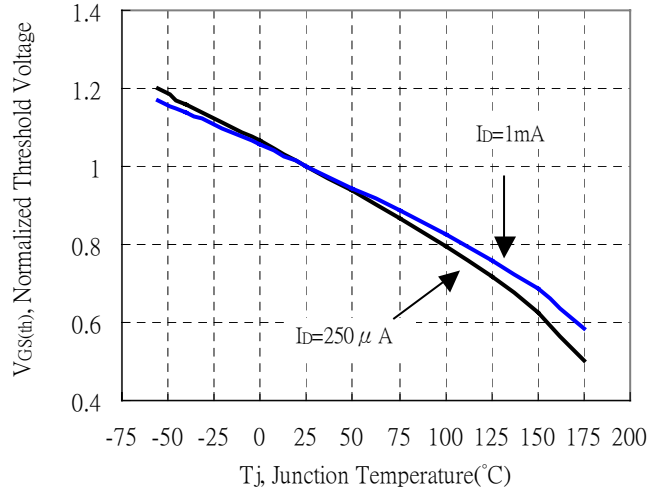

Forward Transfer Admittance vs Drain Current

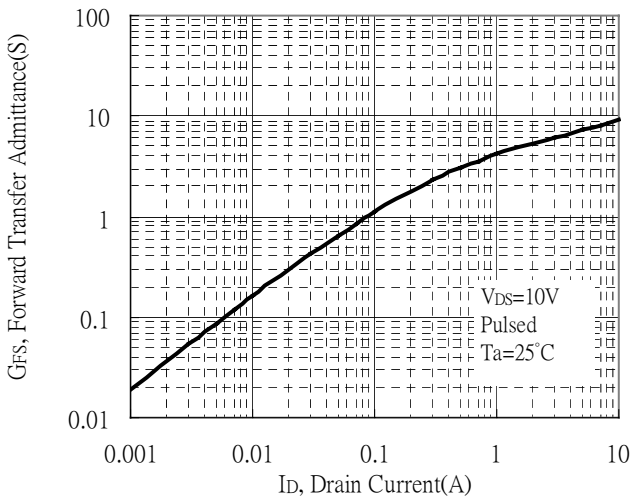

Gate Charge Characteristics

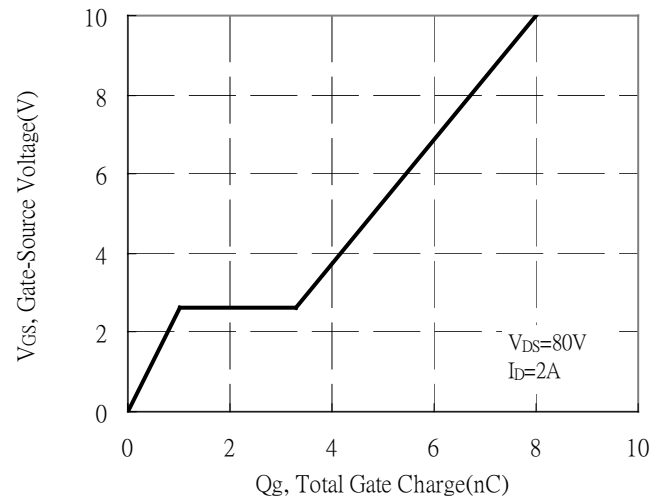

Maximum Safe Operating Area

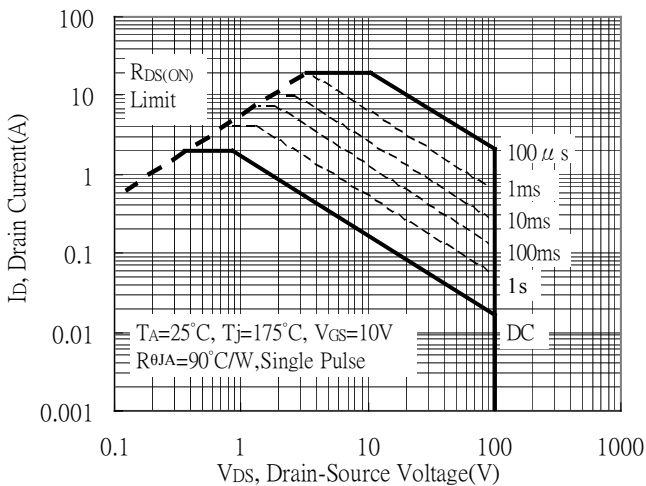

Maximum Drain Current vs Junction Temperature

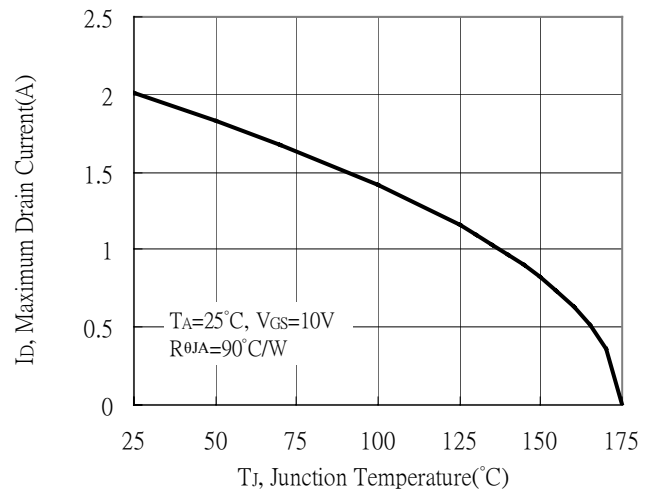



Q1, N-CH Typical Characteristics(Cont.)

Typical Transfer Characteristics

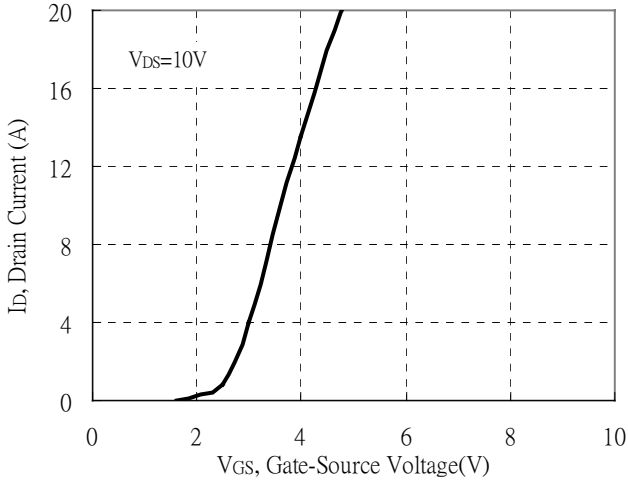

Single Pulse Power Rating, Junction to Ambient
 (Note on page 2)

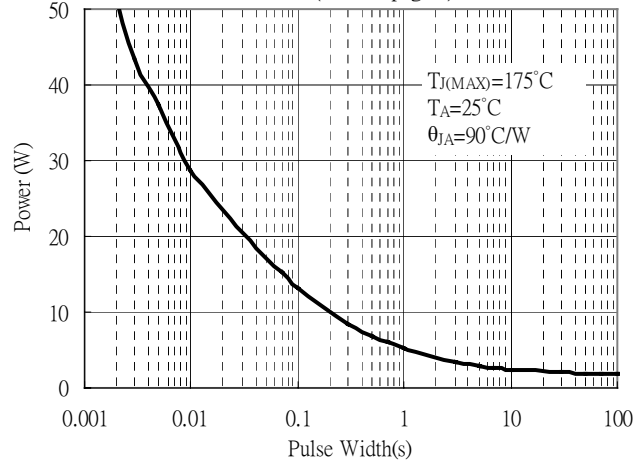

Transient Thermal Response Curves

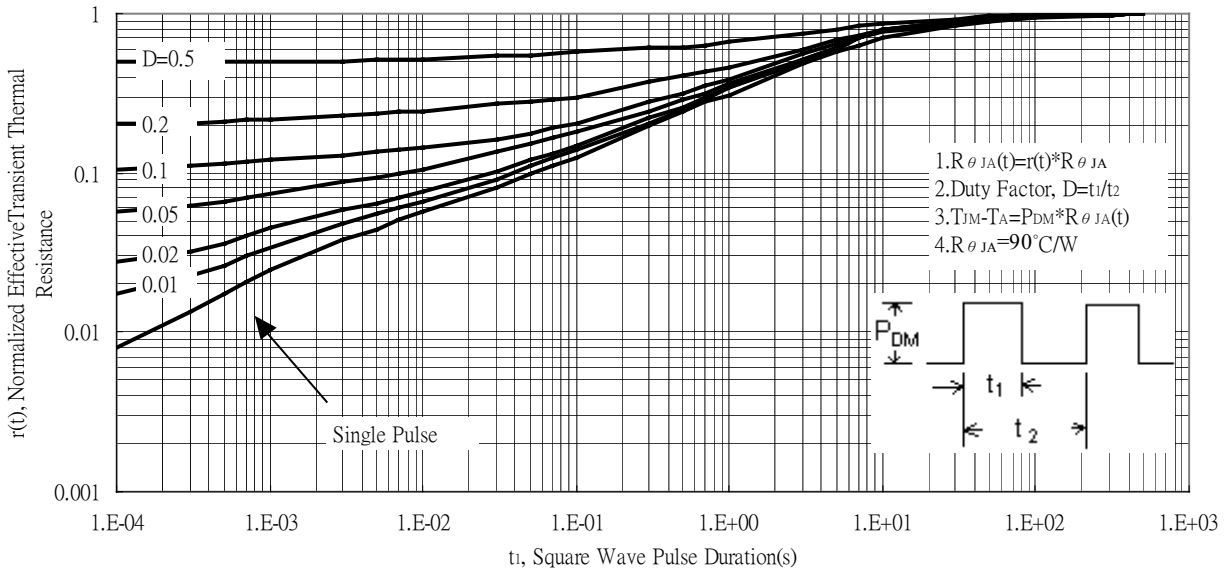

Maximum Drain Current vs Case Temperature

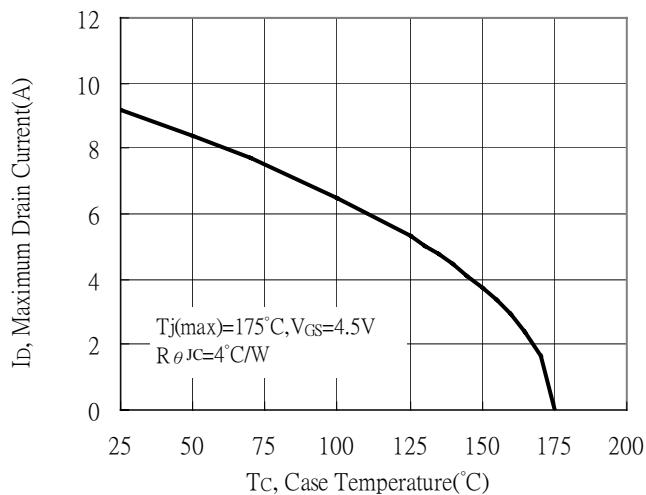

Q2, P-CH Typical Characteristics

Typical Output Characteristics

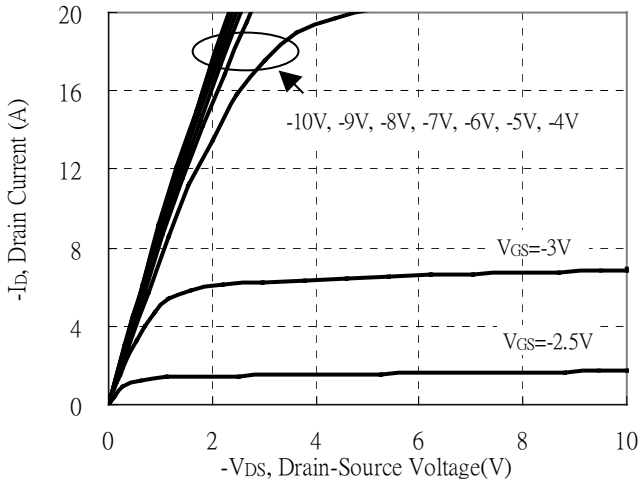

Brekdown Voltage vs Ambient Temperature

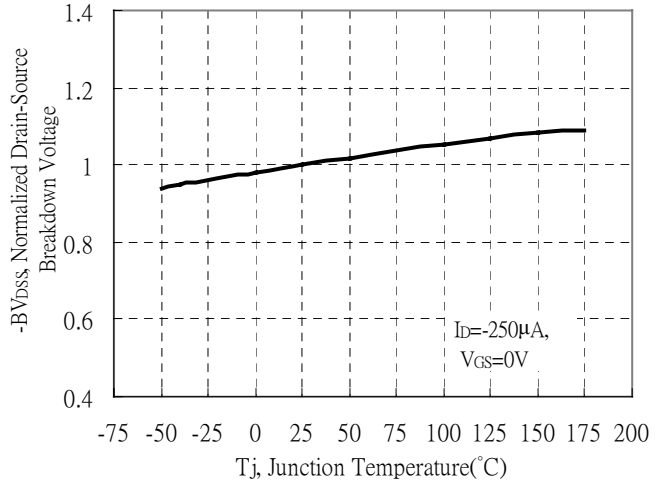

Static Drain-Source On-State resistance vs Drain Current

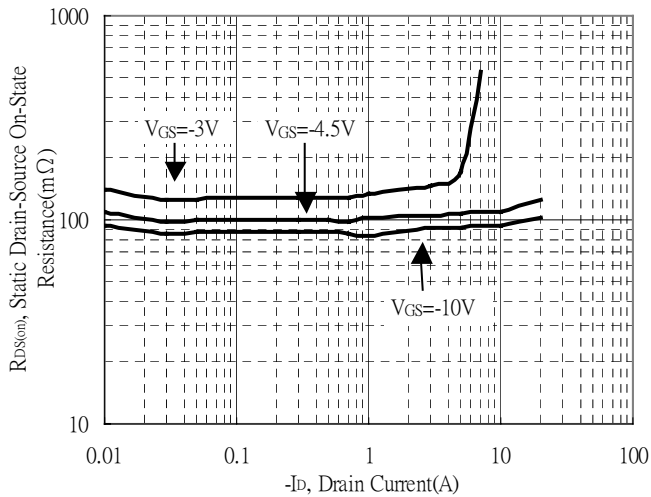

Source Drain Current vs Source-Drain Voltage

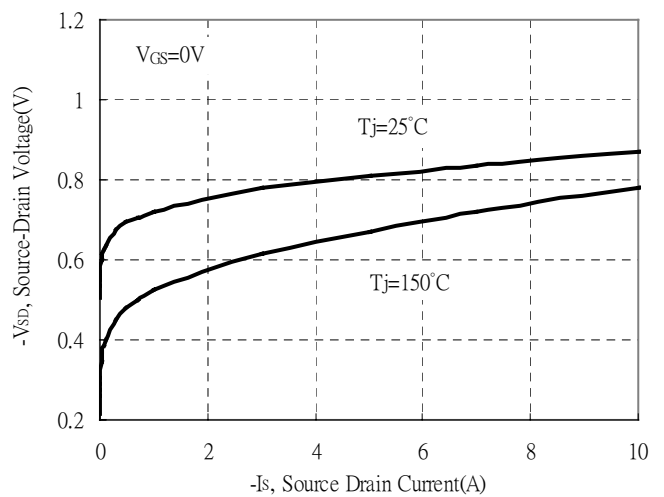

Static Drain-Source On-State Resistance vs Gate-Source Voltage

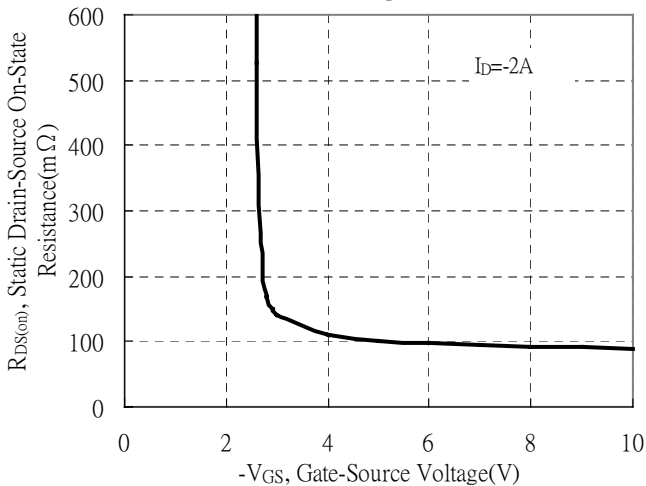

Drain-Source On-State Resistance vs Junction Temperature

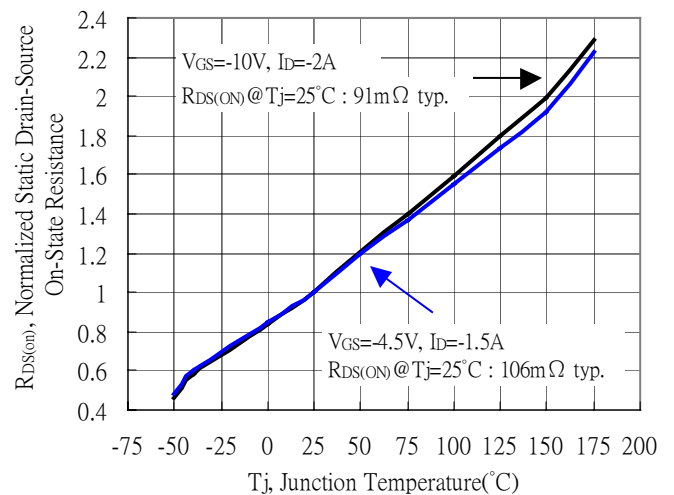



Q2, P-CH Typical Characteristics(Cont.)

Capacitance vs Drain-to-Source Voltage

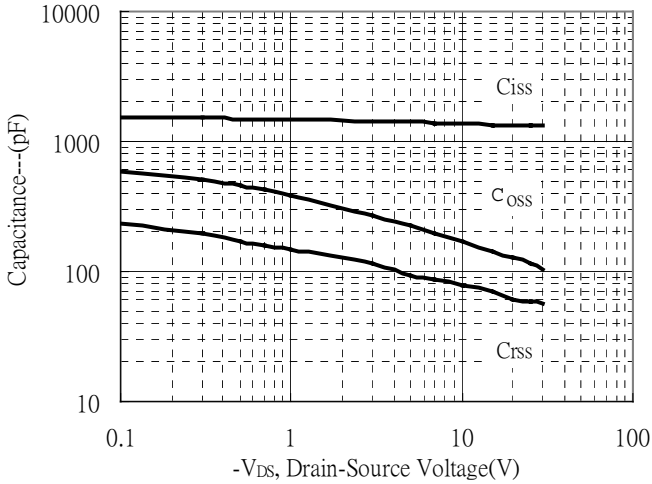

Threshold Voltage vs Junction Temperature

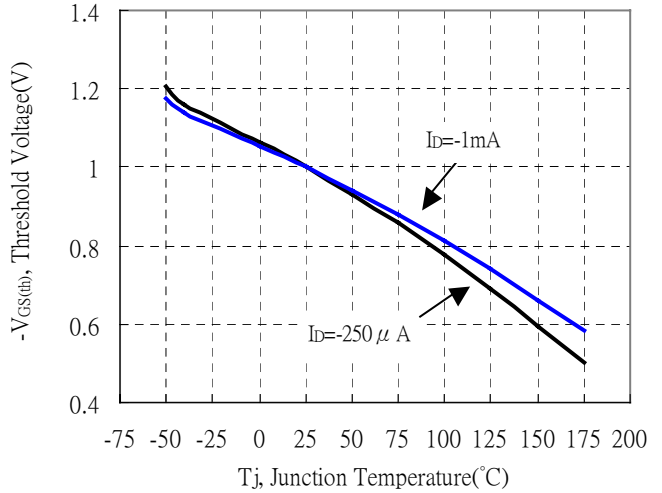

Forward Transfer Admittance vs Drain Current

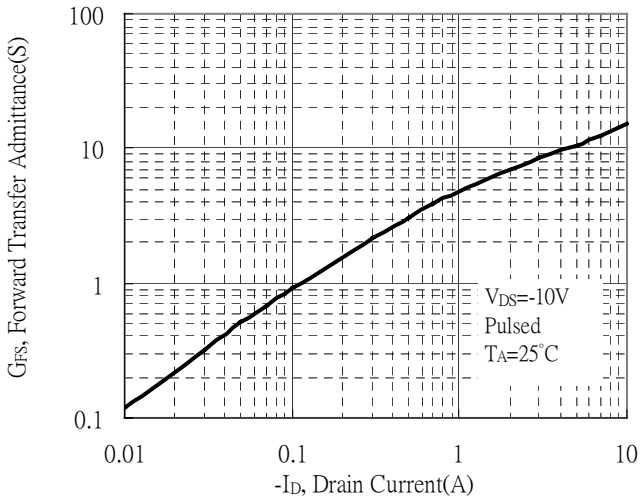

Gate Charge Characteristics

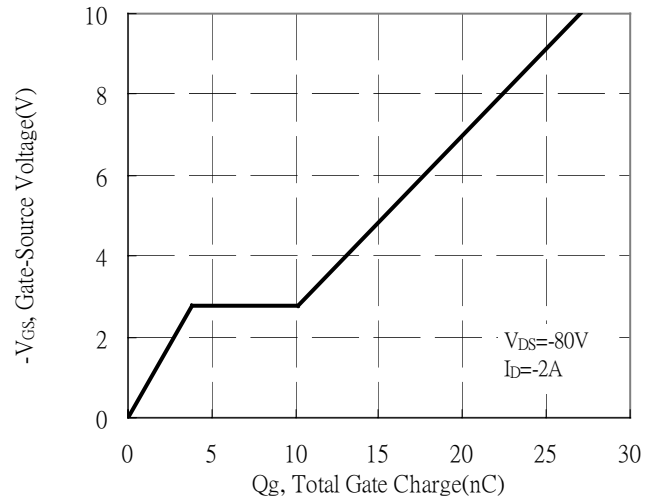

Maximum Safe Operating Area

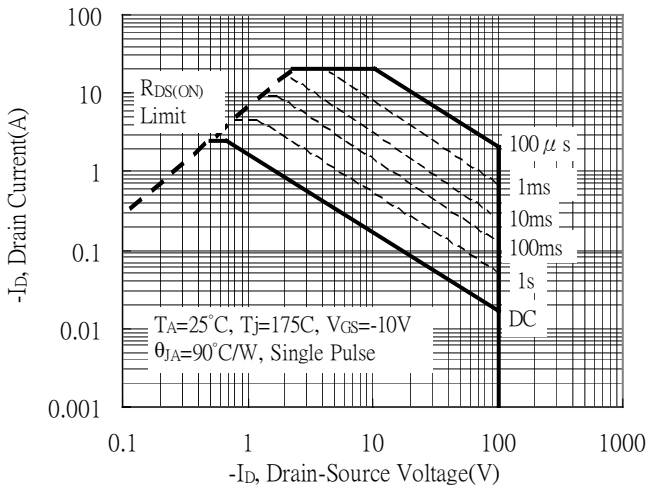

Maximum Drain Current vs Junction Temperature

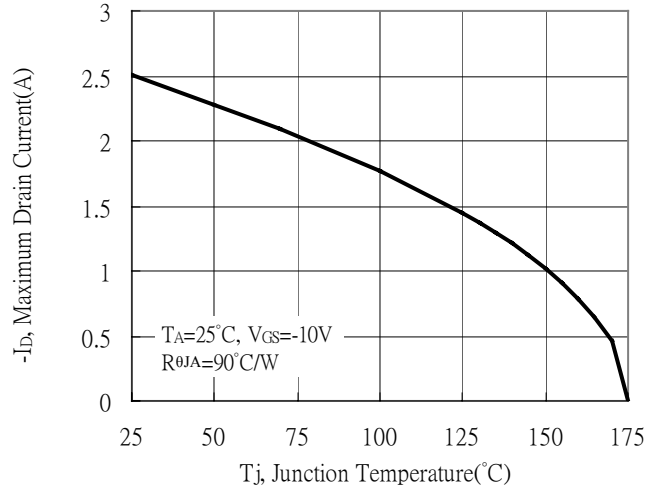



Q2, P-CH Typical Characteristics(Cont.)

Typical Transfer Characteristics

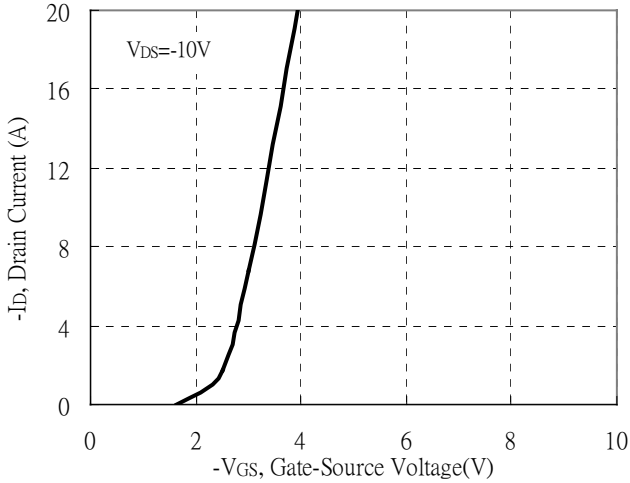

Single Pulse Power Rating, Junction to Ambient
 (Note on page 2)

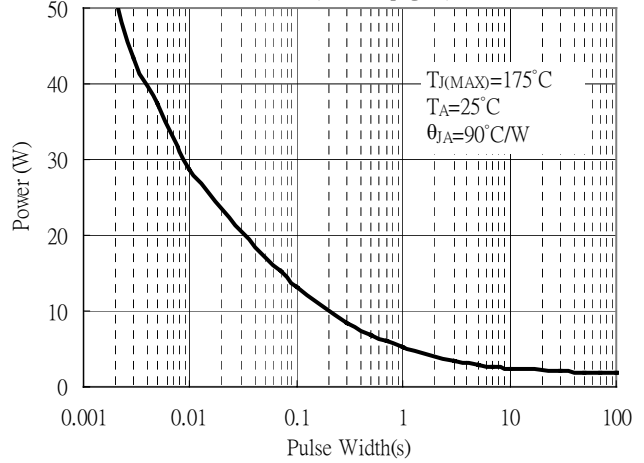

Transient Thermal Response Curves

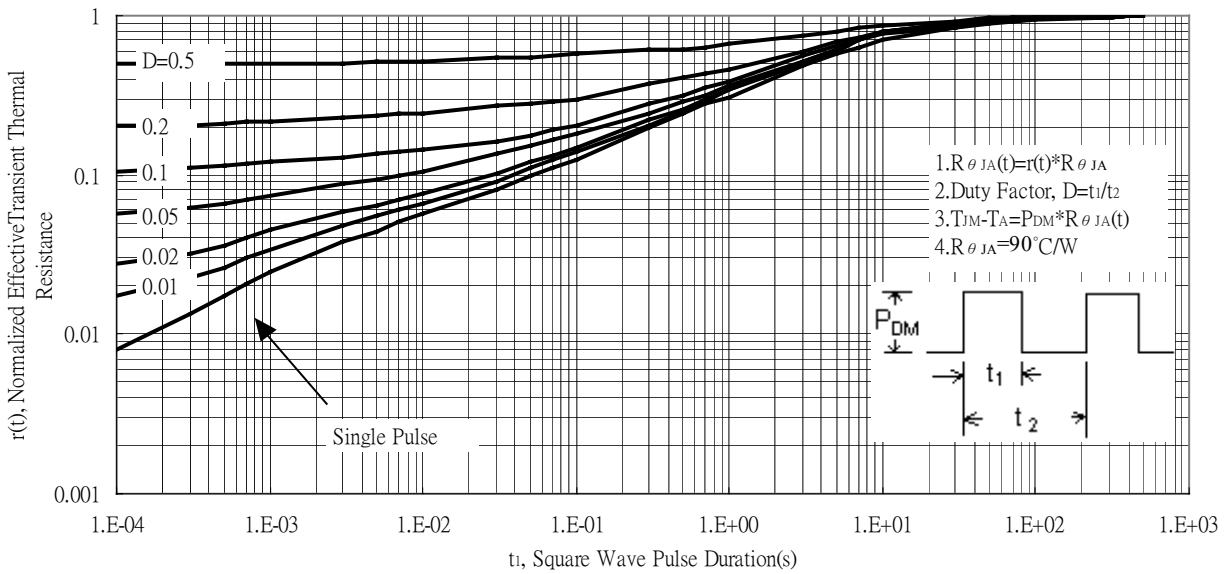

Maximum Drain Current vs Case Temperature

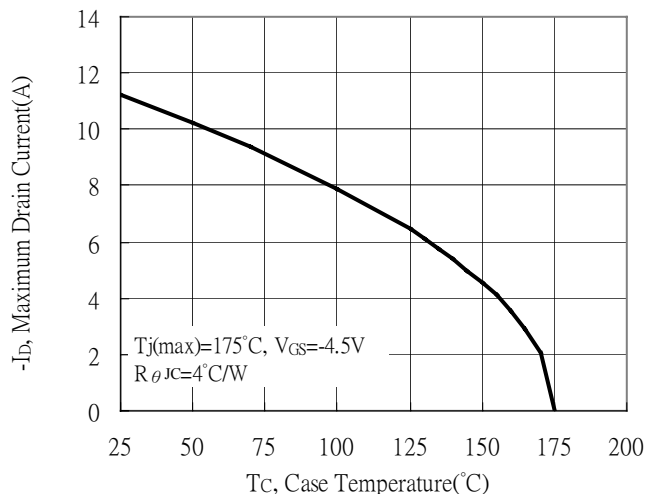

Reel Dimension

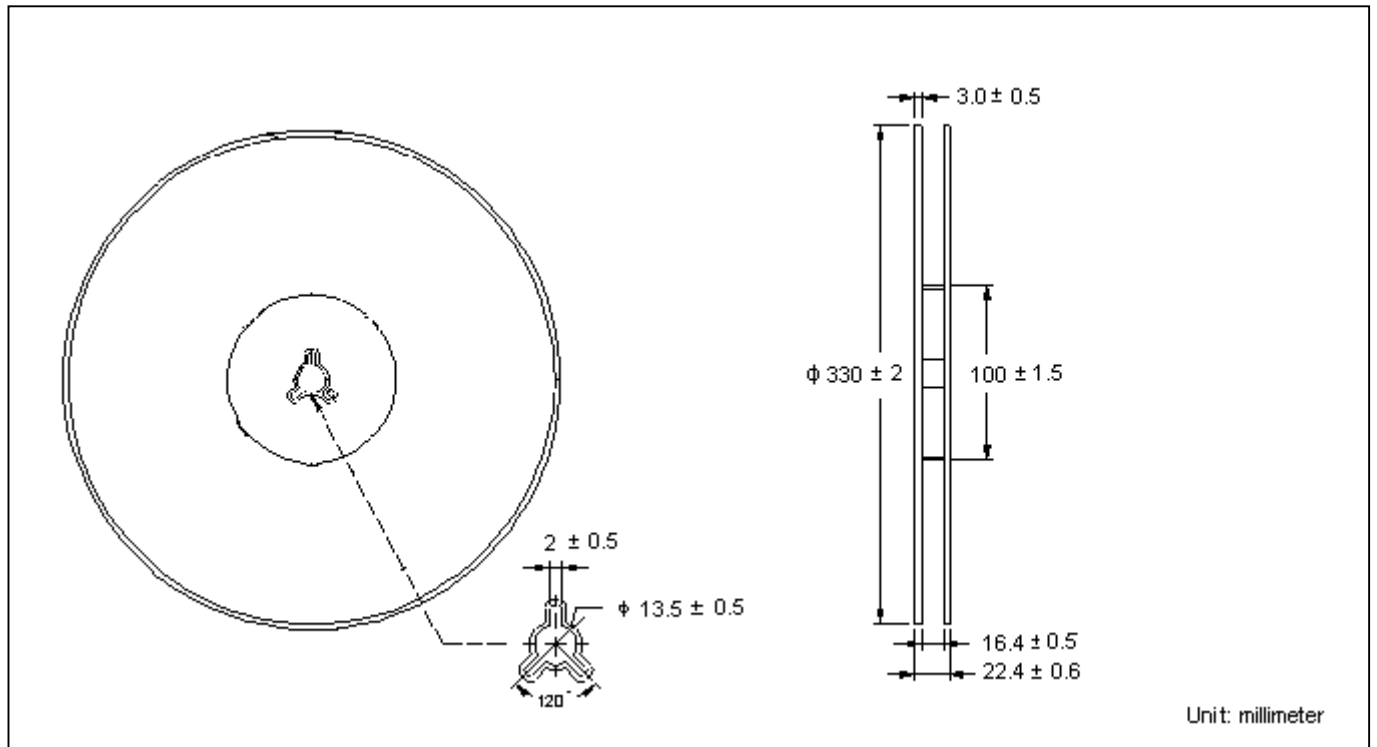

Carrier Tape Dimension

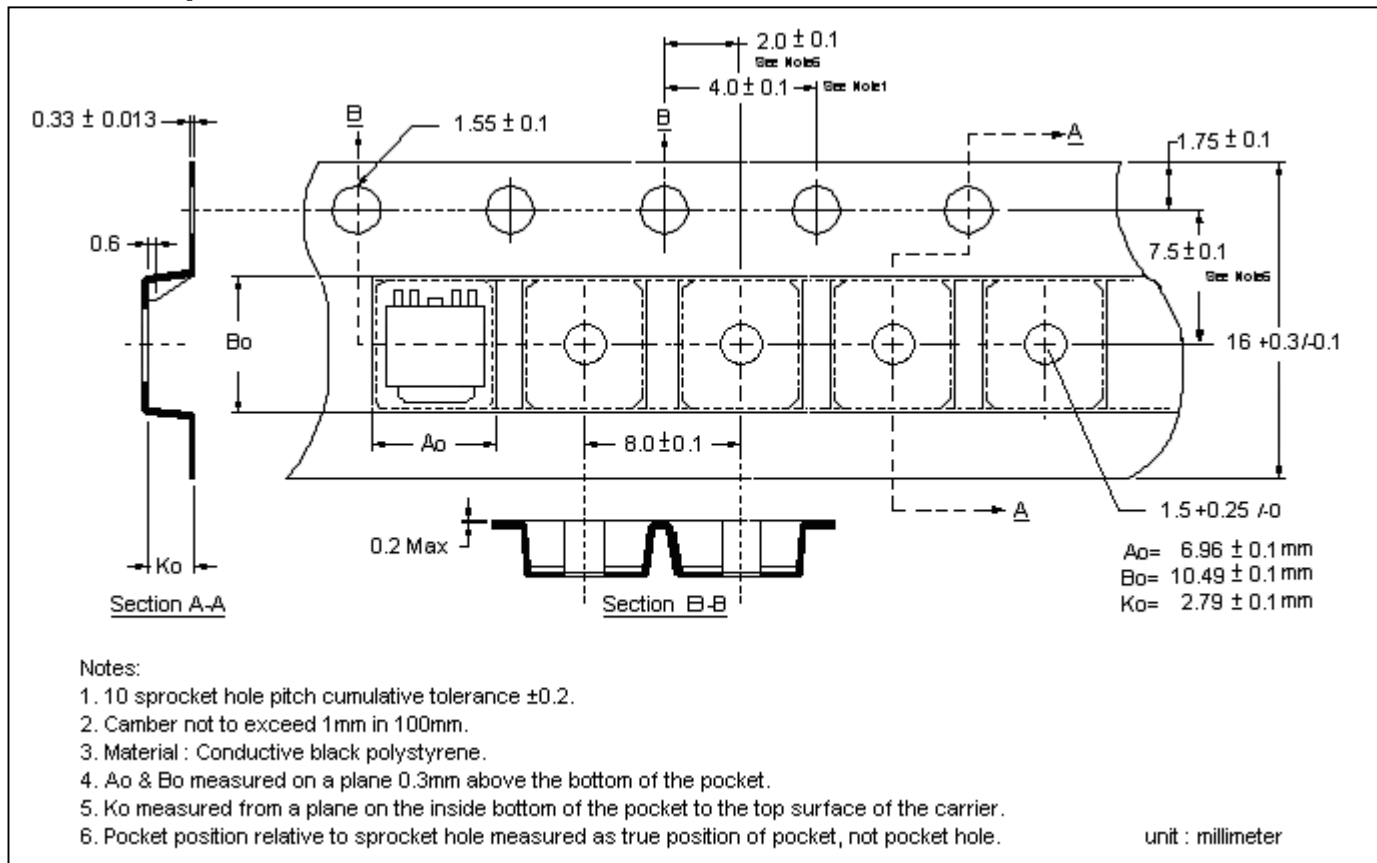

Recommended soldering footprint

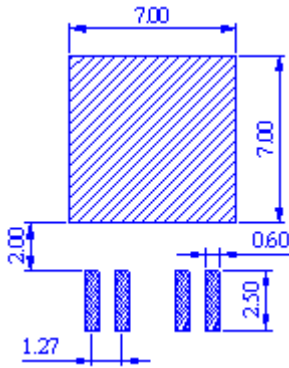

Unit : mm

Recommended wave soldering condition

Product	Peak Temperature	Soldering Time
Pb-free devices	260 +0/-5 °C	5 +1/-1 seconds

Recommended temperature profile for IR reflow

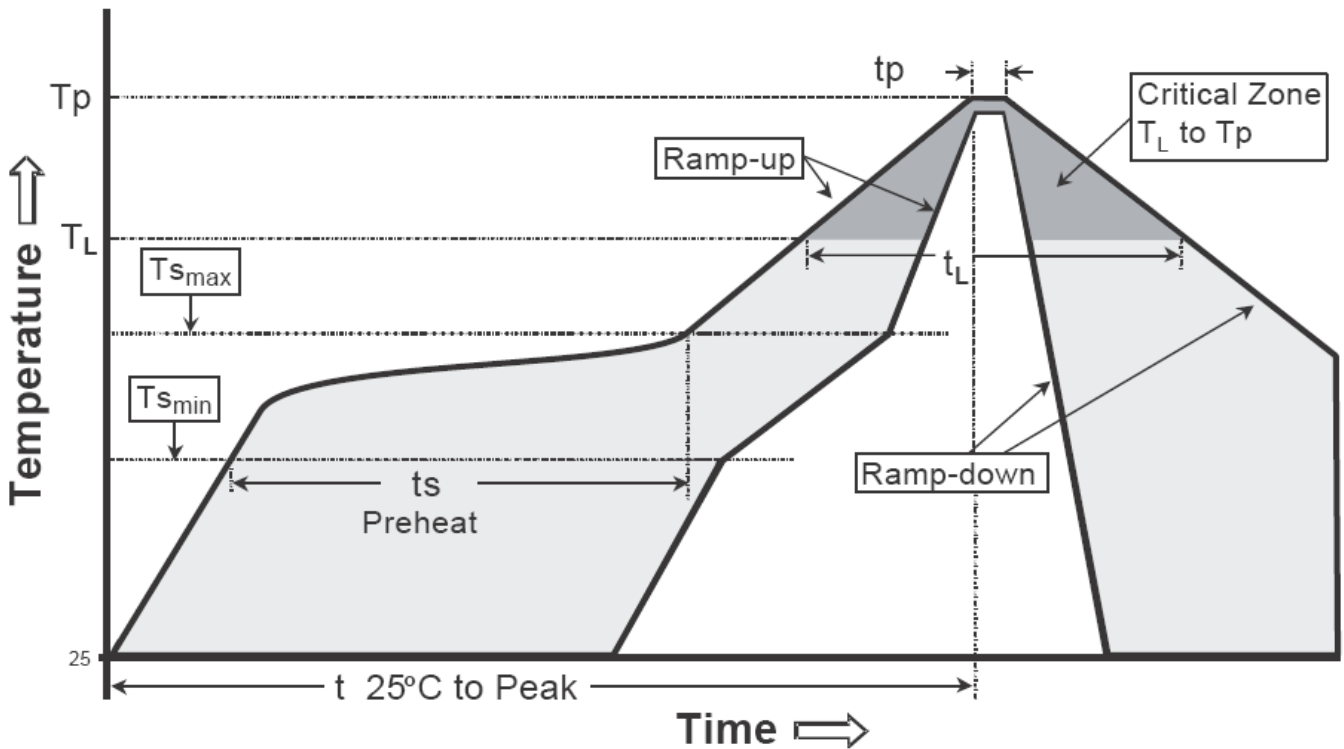

Profile feature	Sn-Pb eutectic Assembly	Pb-free Assembly
Average ramp-up rate (T _{smax} to T _p)	3°C/second max.	3°C/second max.
Preheat		
-Temperature Min(T _{s min})	100°C	150°C
-Temperature Max(T _{s max})	150°C	200°C
-Time(t _{s min} to t _{s max})	60-120 seconds	60-180 seconds
Time maintained above:		
-Temperature (T _L)	183°C	217°C
- Time (t _L)	60-150 seconds	60-150 seconds
Peak Temperature(T _P)	240 +0/-5 °C	260 +0/-5 °C
Time within 5°C of actual peak temperature(tp)	10-30 seconds	20-40 seconds
Ramp down rate	6°C/second max.	6°C/second max.
Time 25 °C to peak temperature	6 minutes max.	8 minutes max.

Note : All temperatures refer to topside of the package, measured on the package body surface.

TO-252-4L Dimension

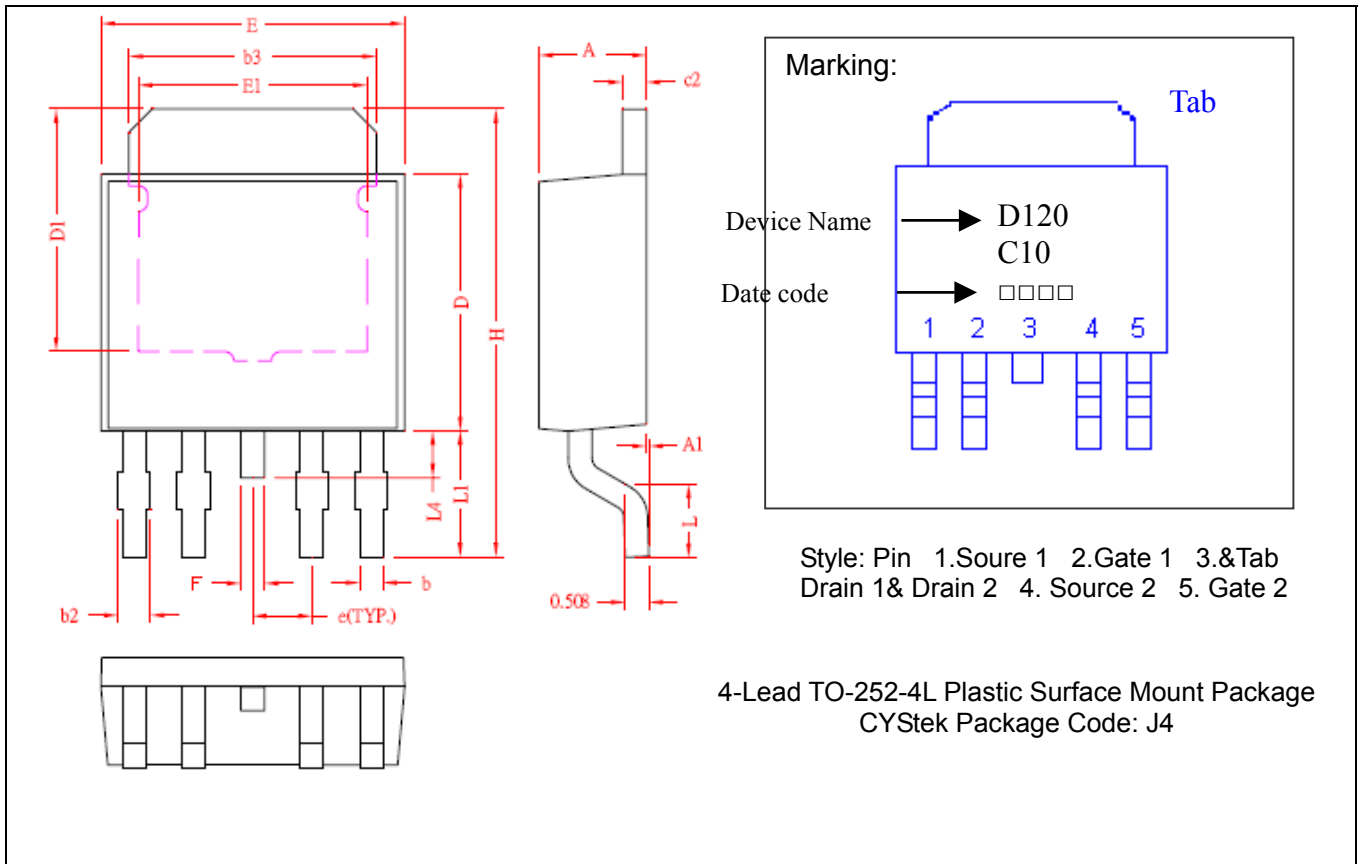

DIM	Inches		Millimeters		DIM	Inches		Millimeters	
	Min.	Max.	Min.	Max.		Min.	Max.	Min.	Max.
A	0.0866	0.0945	2.20	2.40	E	0.2520	0.2677	6.40	6.80
A1	0.0000	0.0059	0.00	0.15	E1	0.1500	-	3.81	-
b	0.0157	0.0236	0.40	0.60	e	0.0500	REF	1.27	REF
b2	0.0199	0.0315	0.50	0.80	F	0.0157	0.0236	0.40	0.60
b3	0.2047	0.2165	5.20	5.50	H	0.3701	0.4016	9.40	10.20
c2	0.0177	0.0217	0.45	0.55	L	0.0551	0.0697	1.40	1.77
D	0.2126	0.2283	5.40	5.80	L1	0.0945	0.1181	2.40	3.00
D1	0.1799	-	4.57	-	L4	0.0315	0.0472	0.80	1.20

Notes: 1.Controlling dimension: millimeters.
 2.Maximum lead thickness includes lead finish thickness, and minimum lead thickness is the minimum thickness of base material.
 3.If there is any question with packing specification or packing method, please contact your local CYStek sales office.

Material:

- Lead : Pure tin plated.
- Mold Compound: Epoxy resin family, flammability solid burning class: UL94V-0.

Important Notice:

- All rights are reserved. Reproduction in whole or in part is prohibited without the prior written approval of CYStek.
- CYStek reserves the right to make changes to its products without notice.
- CYStek **semiconductor products are not warranted to be suitable for use in Life-Support Applications, or systems.**
- CYStek assumes no liability for any consequence of customer product design, infringement of patents, or application assistance.