

N- AND P-Channel Logic Level Enhancement Mode MOSFET

MTC8402S6R

	N-CH	P-CH
BV_{DSS}	60V	-50V
I_D	0.3A	-0.18A
$R_{DSON}(typ.) @V_{GS}=(-)10V$	1.6 Ω	5 Ω
$R_{DSON}(typ.) @V_{GS}=(-)5V$	1.8 Ω	6 Ω

Features

- ESD protected
- High speed switching
- Low-voltage drive
- Pb-free package

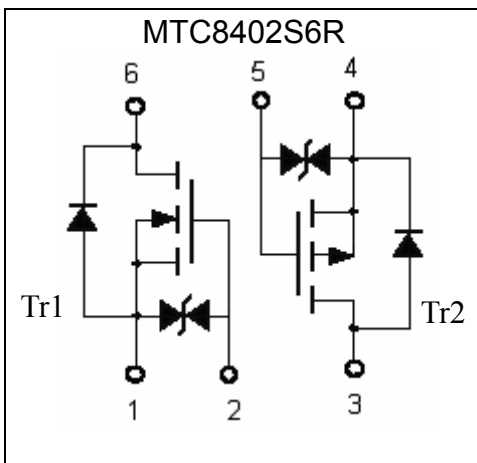
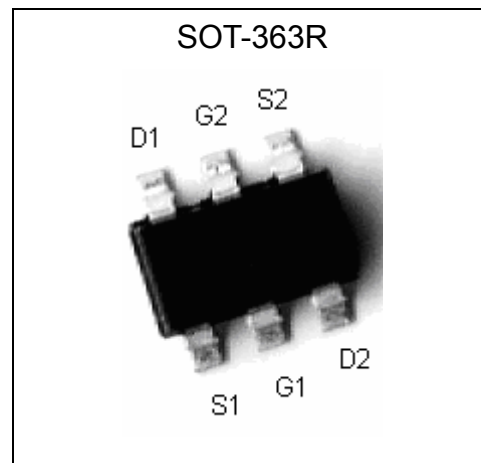
Equivalent Circuit

Outline

The following characteristics apply to both Tr1 and Tr2

Absolute Maximum Ratings ($T_A=25^\circ\text{C}$, unless otherwise noted)

Parameter	Symbol	Limits		Unit
		N-channel	P-channel	
Drain-Source Breakdown Voltage	BV_{DSS}	60	-55	V
Gate-Source Voltage	V_{GS}	± 20	± 20	V
Continuous Drain Current @ $T_A=25^\circ\text{C}$, $V_{GS}=10V(-10V)$	I_D	0.3	-0.18	A
Continuous Drain Current @ $T_A=70^\circ\text{C}$, $V_{GS}=10V(-10V)$	I_D	0.24	-0.14	A
Pulsed Drain Current (Note 1)	I_{DM}	1.2	-0.8	A
Power Dissipation @ $T_A=25^\circ\text{C}$	PD	0.30		W
Power Dissipation @ $T_A=70^\circ\text{C}$		0.18		
Operating Junction and Storage Temperature Range	T_j ; T_{stg}	-55~+150		$^\circ\text{C}$

- Note : 1. Pulse width limited by maximum junction temperature.
 2. Pulse width $\leq 300\mu\text{s}$, duty cycle $\leq 2\%$.
 3. Surface mounted on minimum pad of FR-4 board, $t \leq 5\text{s}$.



Thermal Performance

Parameter	Symbol	Limit	Unit
Thermal Resistance, Junction-to-Ambient(PCB mounted) (Note)	Rth,ja	415	°C/W

Note : Surface mounted on minimum pad of FR-4 board, t≤5s.

Q1, N-Channel Electrical Characteristics (Tj=25°C, unless otherwise noted)

Symbol	Min.	Typ.	Max.	Unit	Test Conditions
Static					
BV _{DSS}	60	-	-	V	V _{GS} =0, I _D =250μA
V _{GS(th)}	1.0	1.6	2.5		V _{DS} =V _{GS} , I _D =250μA
I _{GSS}	-	-	±10	μA	V _{GS} =±20V, V _{DS} =0
I _{DSS}	-	-	1		V _{DS} =48V, V _{GS} =0
	-	-	10		V _{DS} =48V, V _{GS} =0 (Tj=70°C)
*R _{DSON}	-	1.6	2.2	Ω	V _{GS} =10V, I _D =500mA
	-	1.8	2.4		V _{GS} =5V, I _D =100mA
	-	1.9	2.5		V _{GS} =4.5V, I _D =100mA
*G _{FS}	-	100	-	mS	V _{DS} =10V, I _D =100mA
Dynamic					
C _{iss}	-	29.3	-	pF	V _{DS} =25V, V _{GS} =0, f=1MHz
C _{oss}	-	4.2	-		
C _{rss}	-	2.8	-		
t _{d(ON)}	-	8	-	ns	V _{DS} =30V, I _D =100mA, V _{GS} =10V, R _G =25 Ω
t _r	-	6	-		
t _{d(OFF)}	-	11	-		
t _f	-	8	-		
Q _g	-	0.77	-	nC	V _{DS} =30V, I _D =300mA, V _{GS} =10V
Q _{gs}	-	0.1	-		
Q _{gd}	-	0.25	-		
Source-Drain Diode					
*I _S	-	-	0.3	A	
*I _{SM}	-	-	1.2		
*V _{SD}	-	0.8	1.2	V	V _{GS} =0V, I _S =100mA

*Pulse Test : Pulse Width ≤300μs, Duty Cycle ≤2%



Q2, P-Channel Electrical Characteristics (Tj=25°C, unless otherwise noted)

Symbol	Min.	Typ.	Max.	Unit	Test Conditions
Static					
BV _{DSS}	-50	-	-	V	V _{GS} =0, I _D =-250μA
V _{GS(th)}	-1	-1.4	-2		V _{DS} =V _{GS} , I _D =-250μA
I _{GSS}	-	-	±20	μA	V _{GS} =±20V, V _{DS} =0
I _{DSS}	-	-	-1		V _{DS} =-40V, V _{GS} =0
	-	-	-10		V _{DS} =-40V, V _{GS} =0 (Tj=70°C)
*R _{DS(ON)}	-	5	6.5	Ω	V _{GS} =-10V, I _D =-100mA
	-	6	8		V _{GS} =-5V, I _D =-100mA
*G _{FS}	80	-	-	mS	V _{DS} =-10V, I _D =-100mA
Dynamic					
C _{iss}	-	24.1	-	pF	V _{DS} =-25V, V _{GS} =0, f=1MHz
C _{oss}	-	4.6	-		
C _{rss}	-	1.5	-		
t _{d(ON)}	-	6	-	ns	V _{DS} =-25V, I _D =-100mA, V _{GS} =-10V, R _G =25Ω
t _r	-	3	-		
t _{d(OFF)}	-	10	-		
t _f	-	4	-		
Q _g	-	0.53	-	nC	V _{DS} =-25V, I _D =-180mA, V _{GS} =-10V
Q _{gs}	-	0.07	-		
Q _{gd}	-	0.17	-		
Source-Drain Diode					
*I _S	-	-	-0.18	A	
*I _{SM}	-	-	-0.8		
*V _{SD}	-	-0.85	-1.2	V	V _{GS} =0V, I _S =-130mA

Ordering Information

Device	Package	Shipping
MTC8402S6R-0-T1-G	SOT-363 (Pb-free lead plating and Halogen-free package)	3000 pcs / Tape & Reel

Q1, N-Channel Typical Characteristics

Typical Output Characteristics

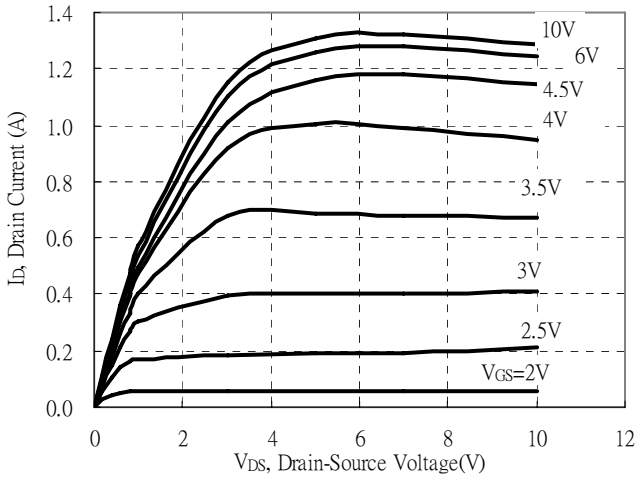

Breakdown Voltage vs Ambient Temperature

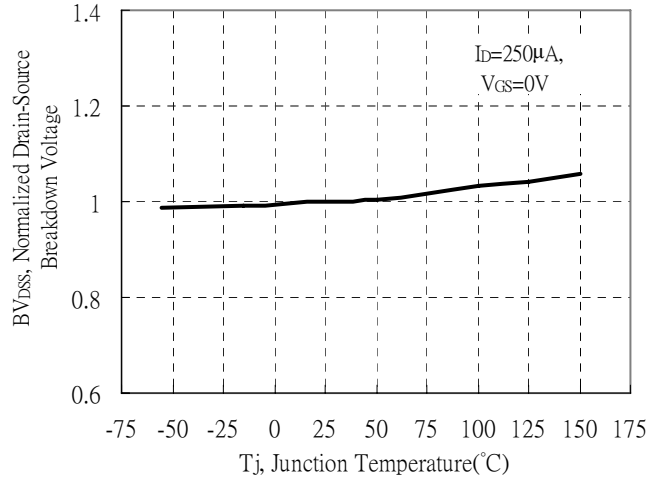

Static Drain-Source On-State resistance vs Drain Current

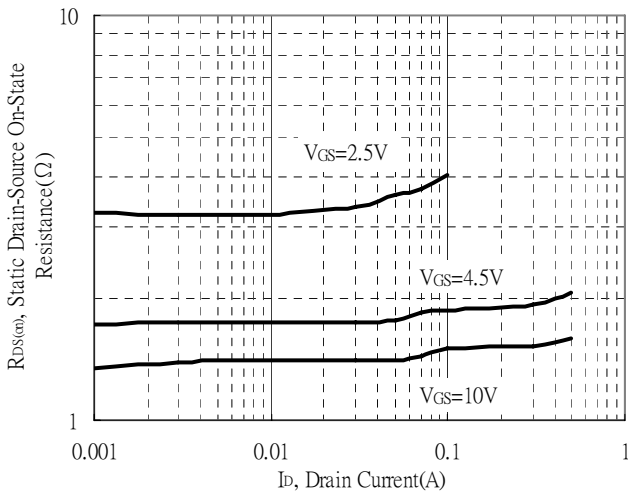

Reverse Drain Current vs Source-Drain Voltage

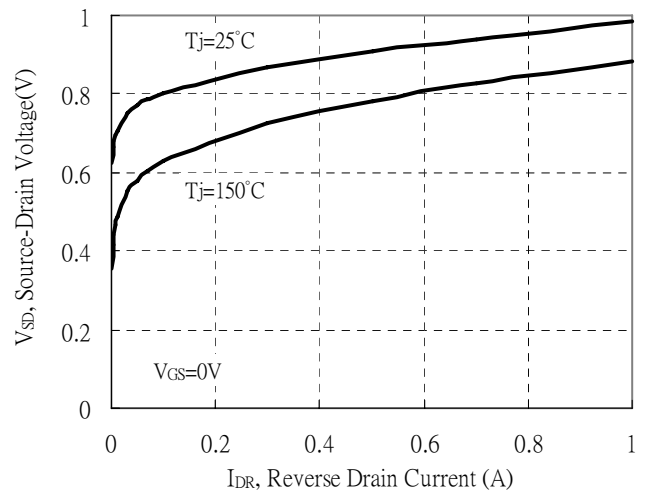

Static Drain-Source On-State Resistance vs Gate-Source Voltage

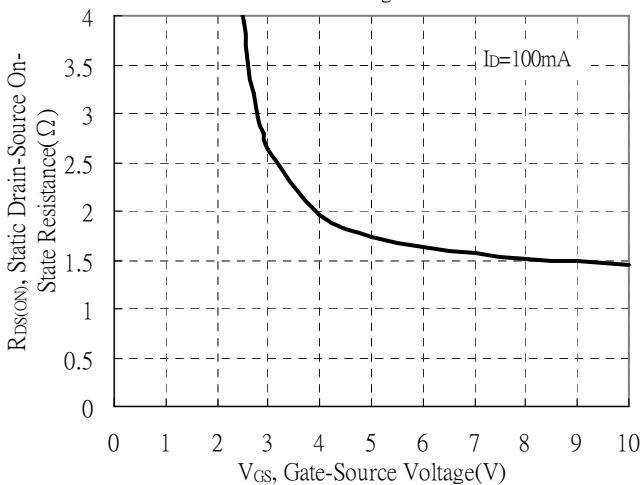

Drain-Source On-State Resistance vs Junction Temperature

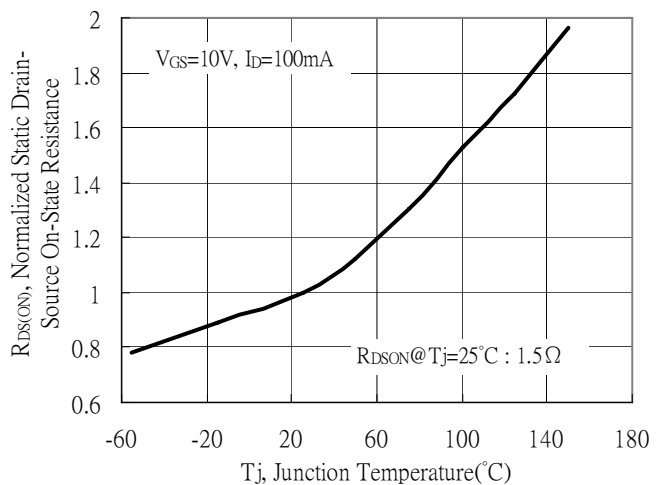

Q1, N-Channel Typical Characteristics(Cont.)

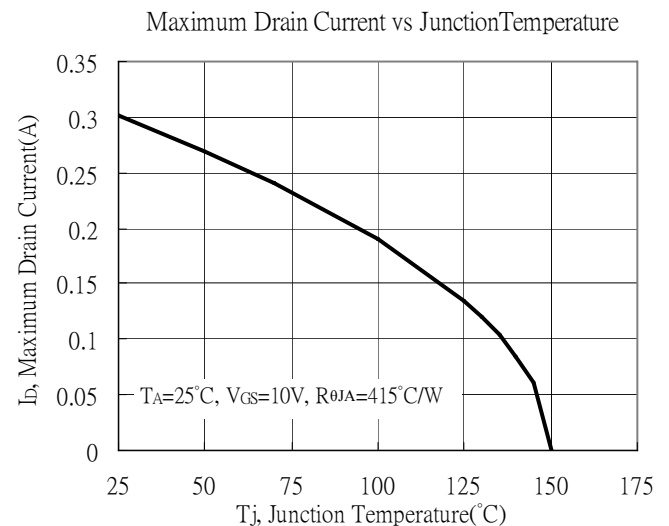
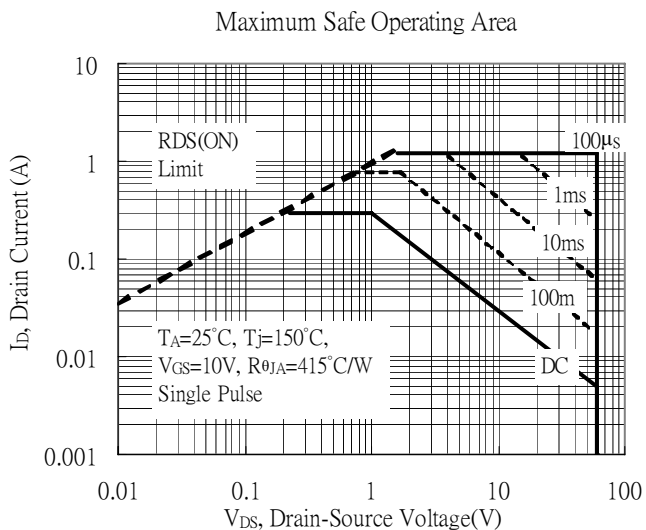
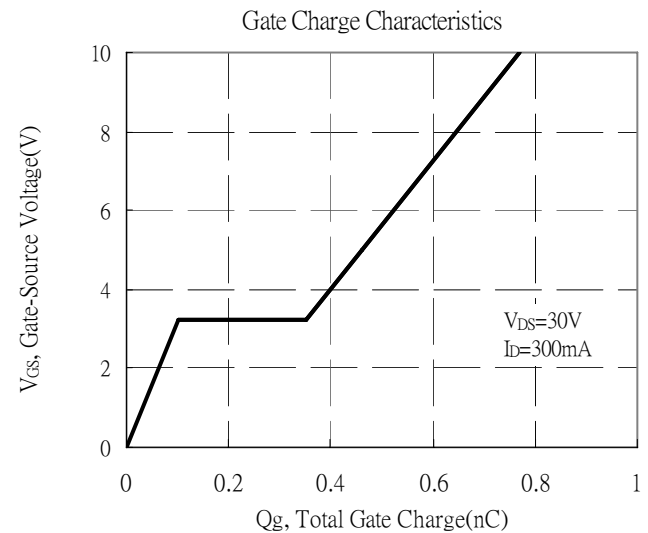
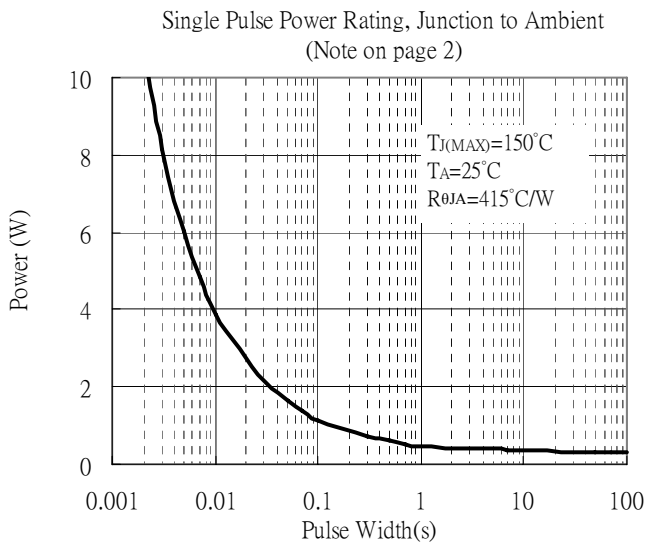
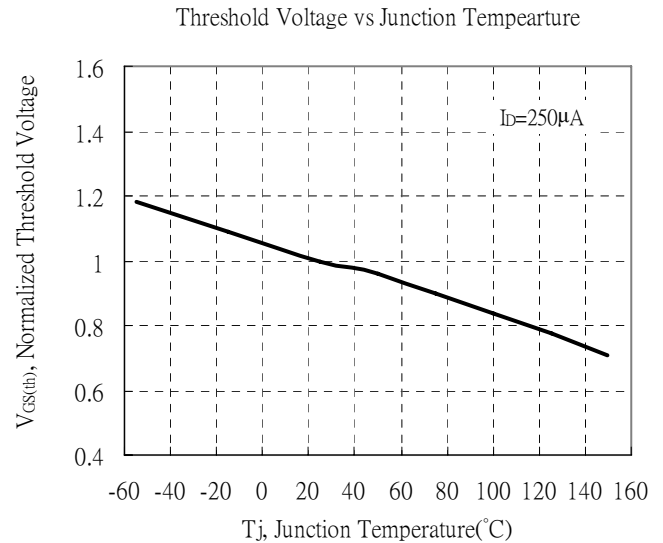
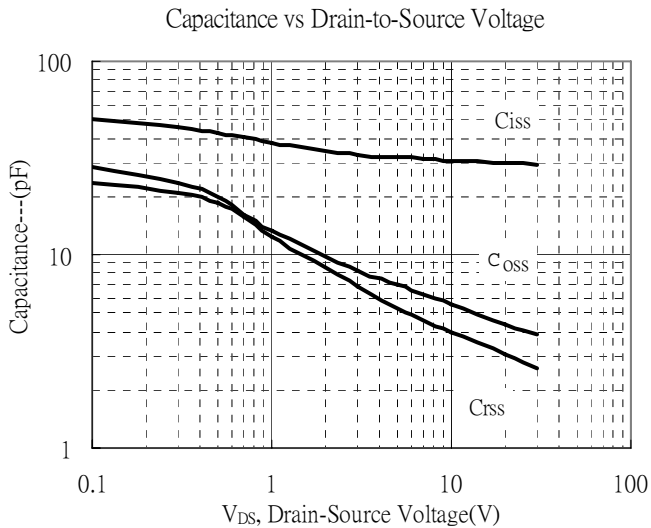

Q1, N-Channel Typical Characteristics(Cont.)

Typical Transfer Characteristics

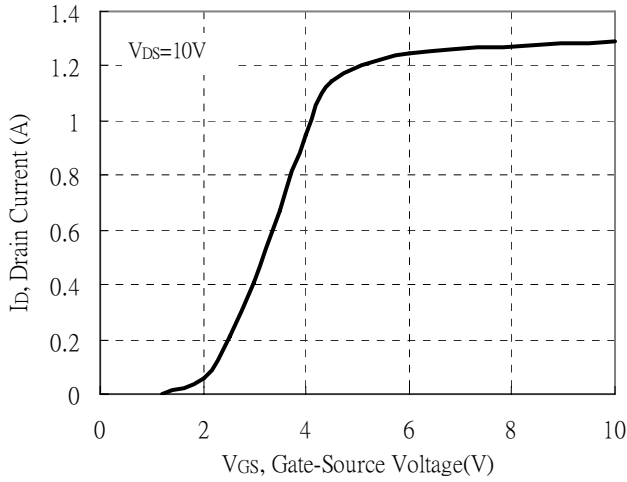

Power Derating Curve

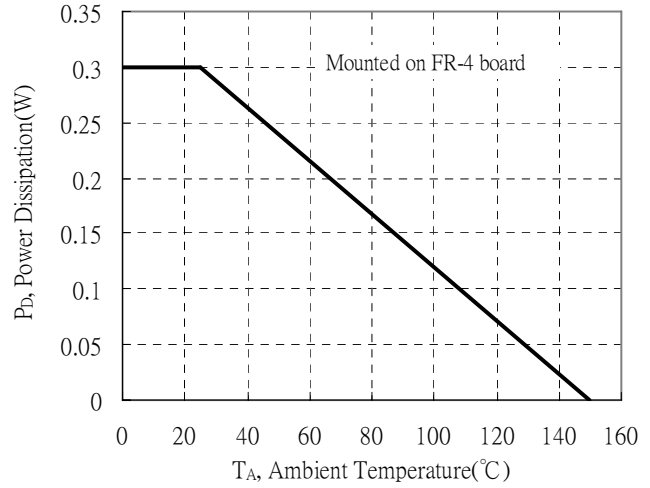

Transient Thermal Response Curves

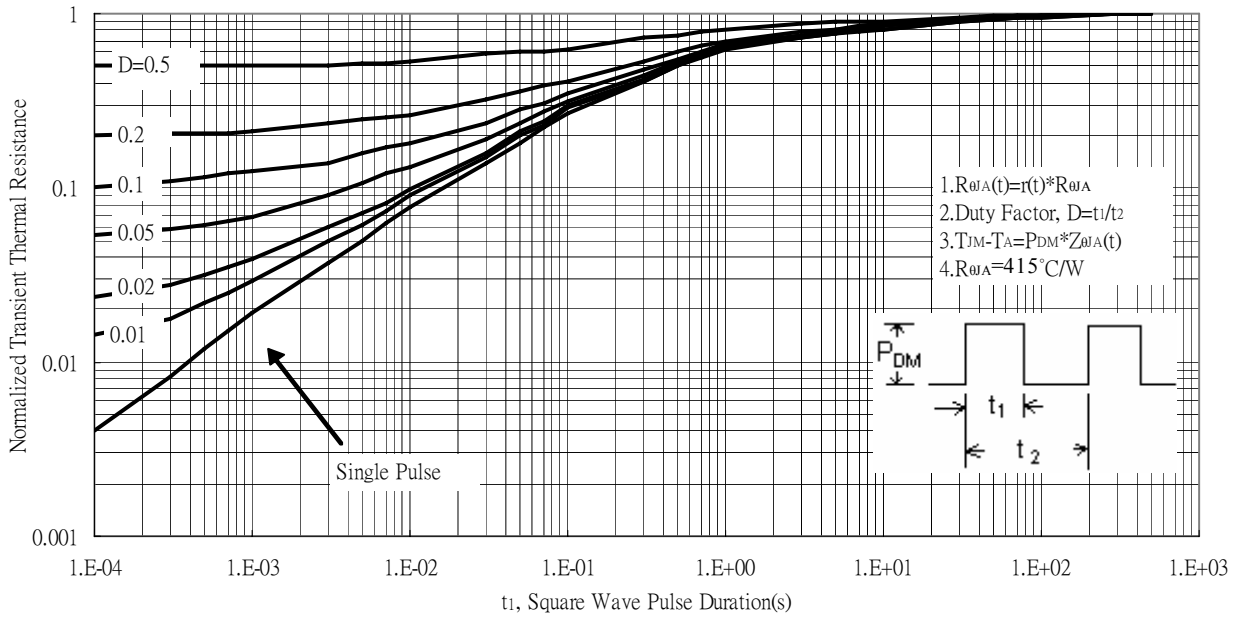

Q2, P-Channel Typical Characteristics

Typical Output Characteristics

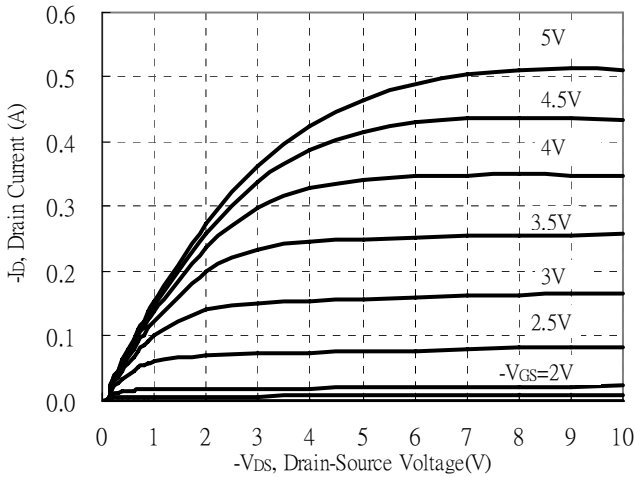

Brekdown Voltage vs Ambient Temperature

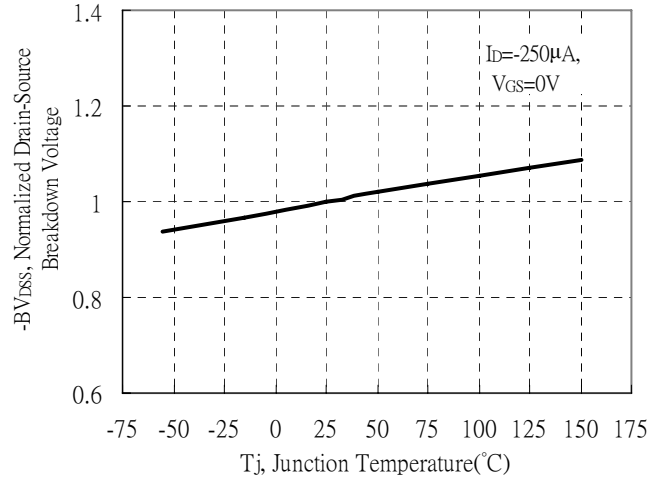

Static Drain-Source On-State resistance vs Drain Current

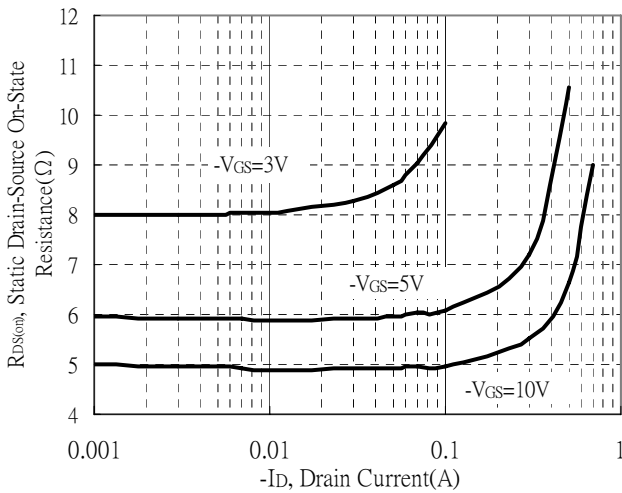

Reverse Drain Current vs Source-Drain Voltage

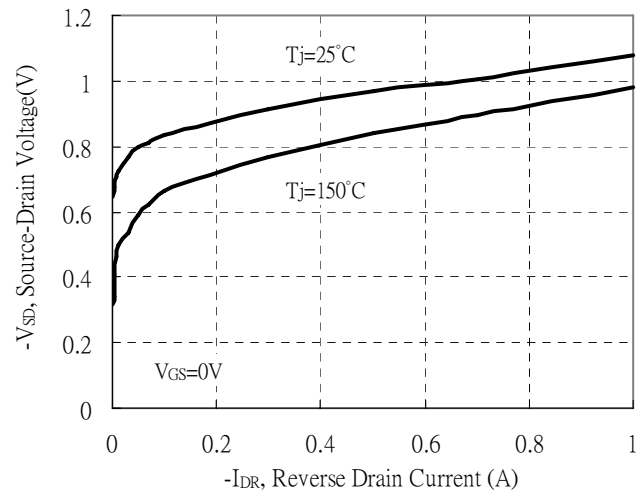

Static Drain-Source On-State Resistance vs Gate-Source Voltage

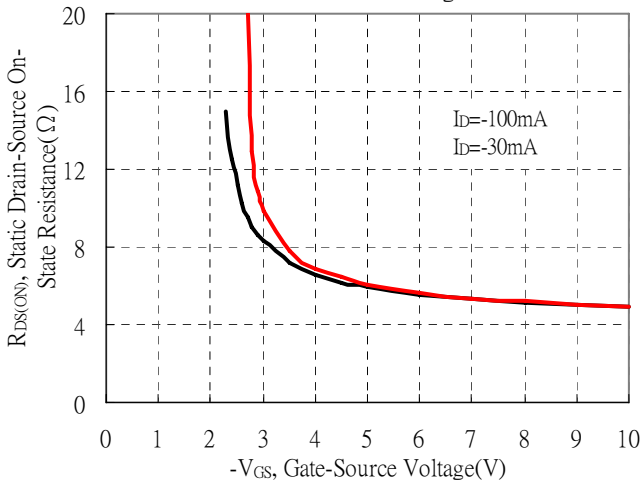

Drain-Source On-State Resistance vs Junction Temperature

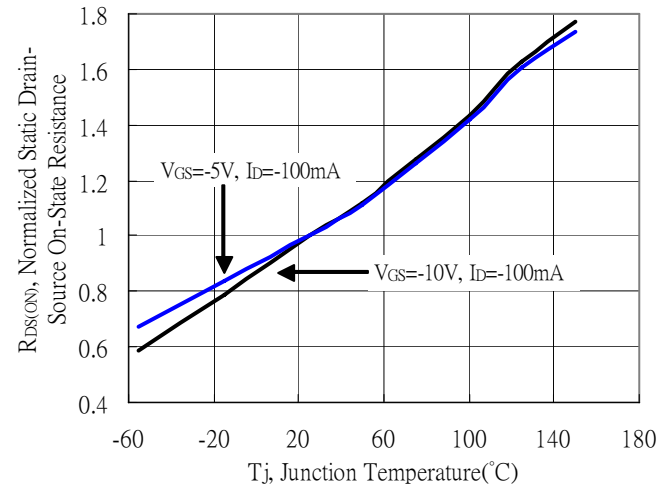



Q2, P-Channel Typical Characteristics(Cont.)

Capacitance vs Drain-to-Source Voltage

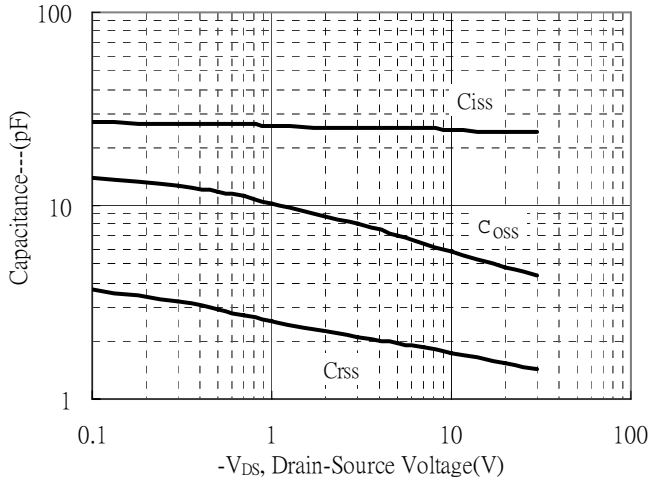

Threshold Voltage vs Junction Temperature

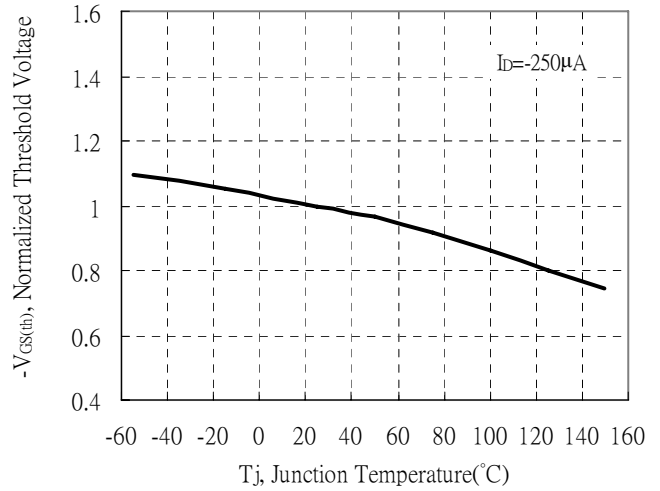

Single Pulse Power Rating, Junction to Ambient
(Note on page 2)

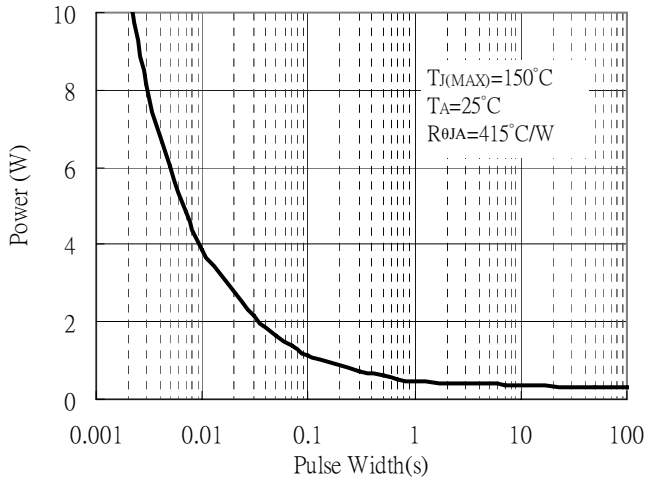

Gate Charge Characteristics

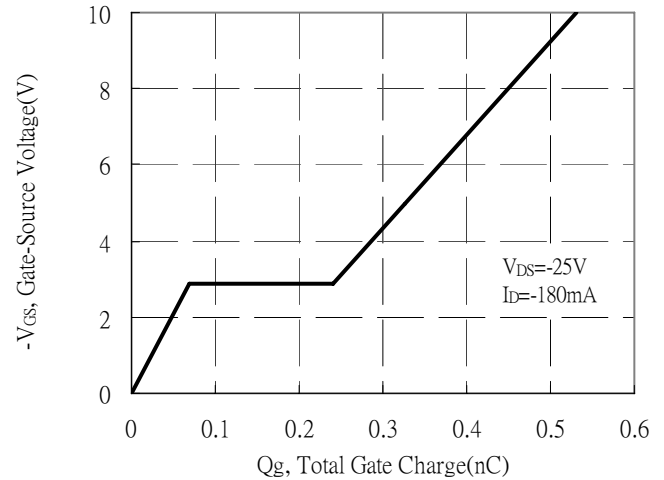

Maximum Safe Operating Area

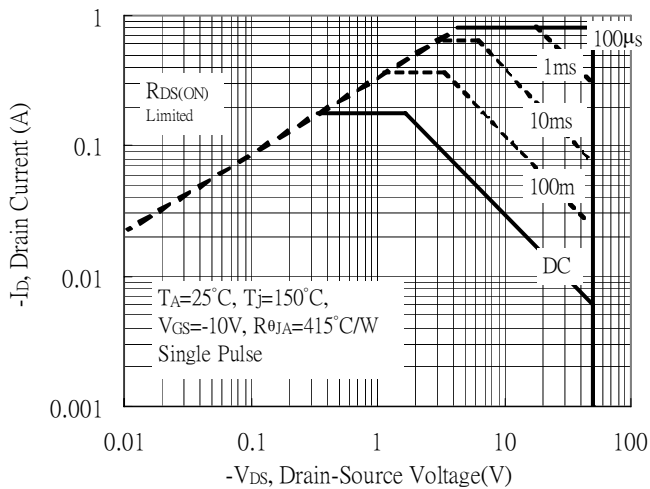

Maximum Drain Current vs Junction Temperature

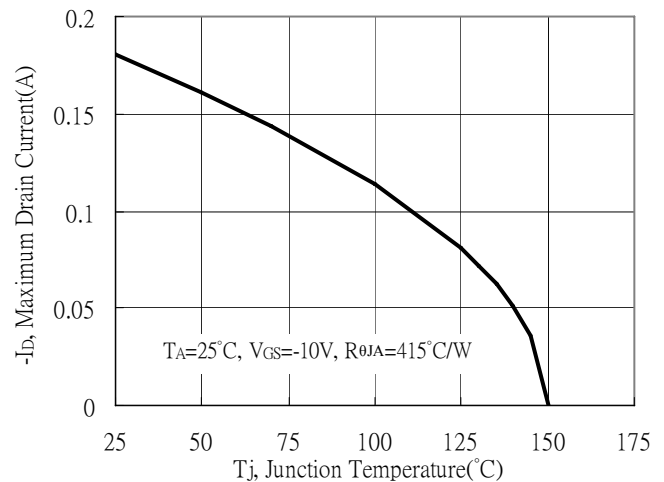

Q2, P-Channel Typical Characteristics(Cont.)

Typical Transfer Characteristics

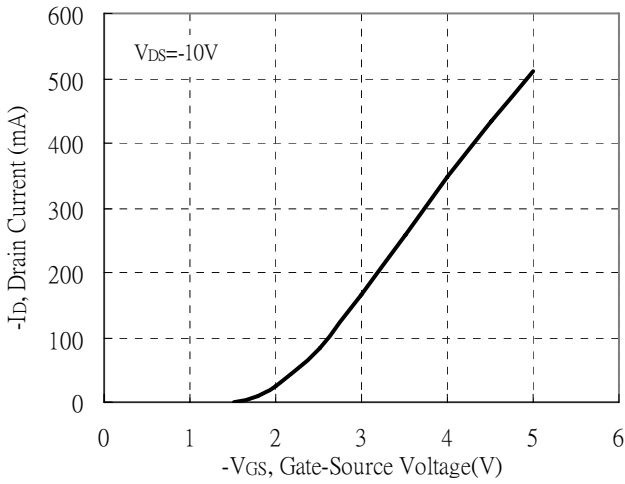

Power Derating Curve

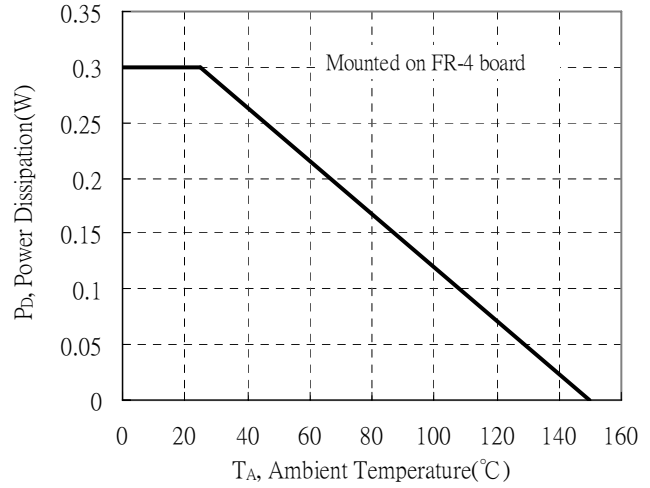

Transient Thermal Response Curves

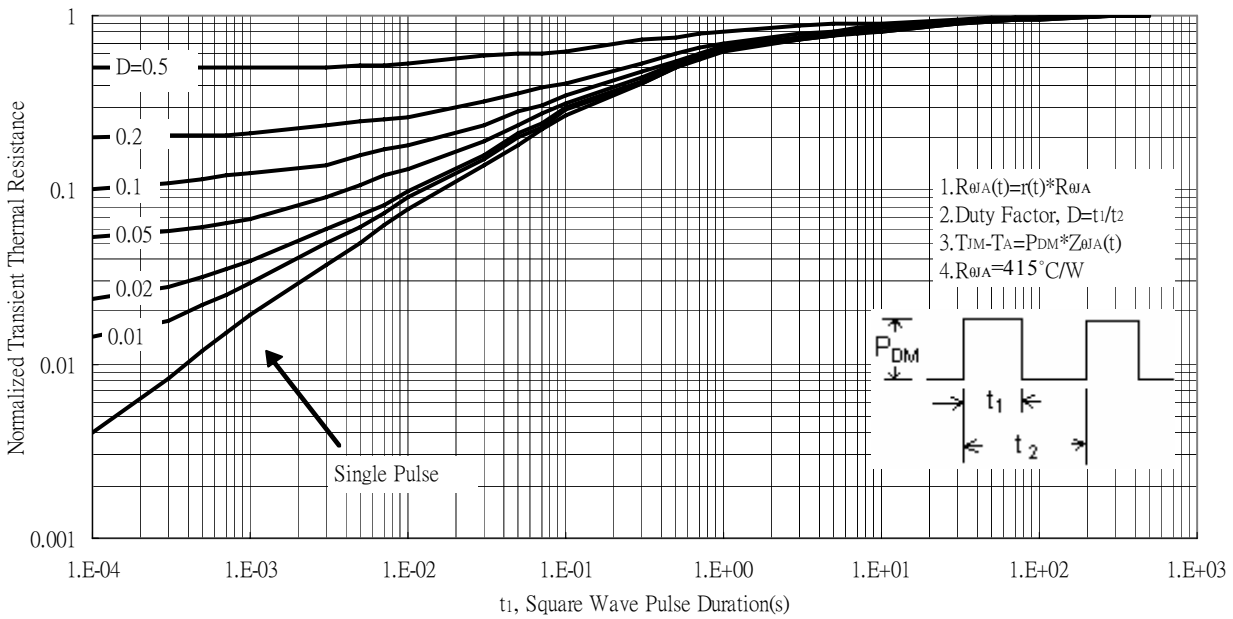

Reel Dimension

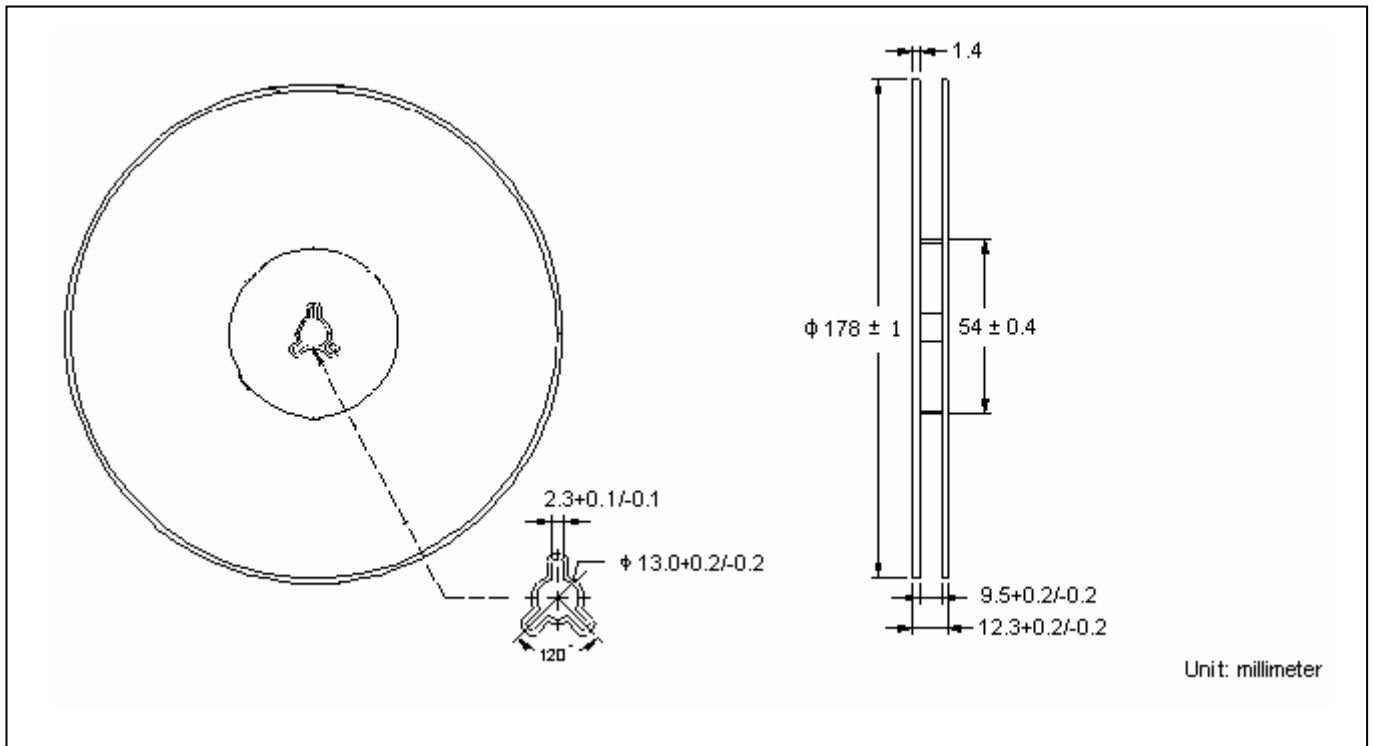

Carrier Tape Dimension

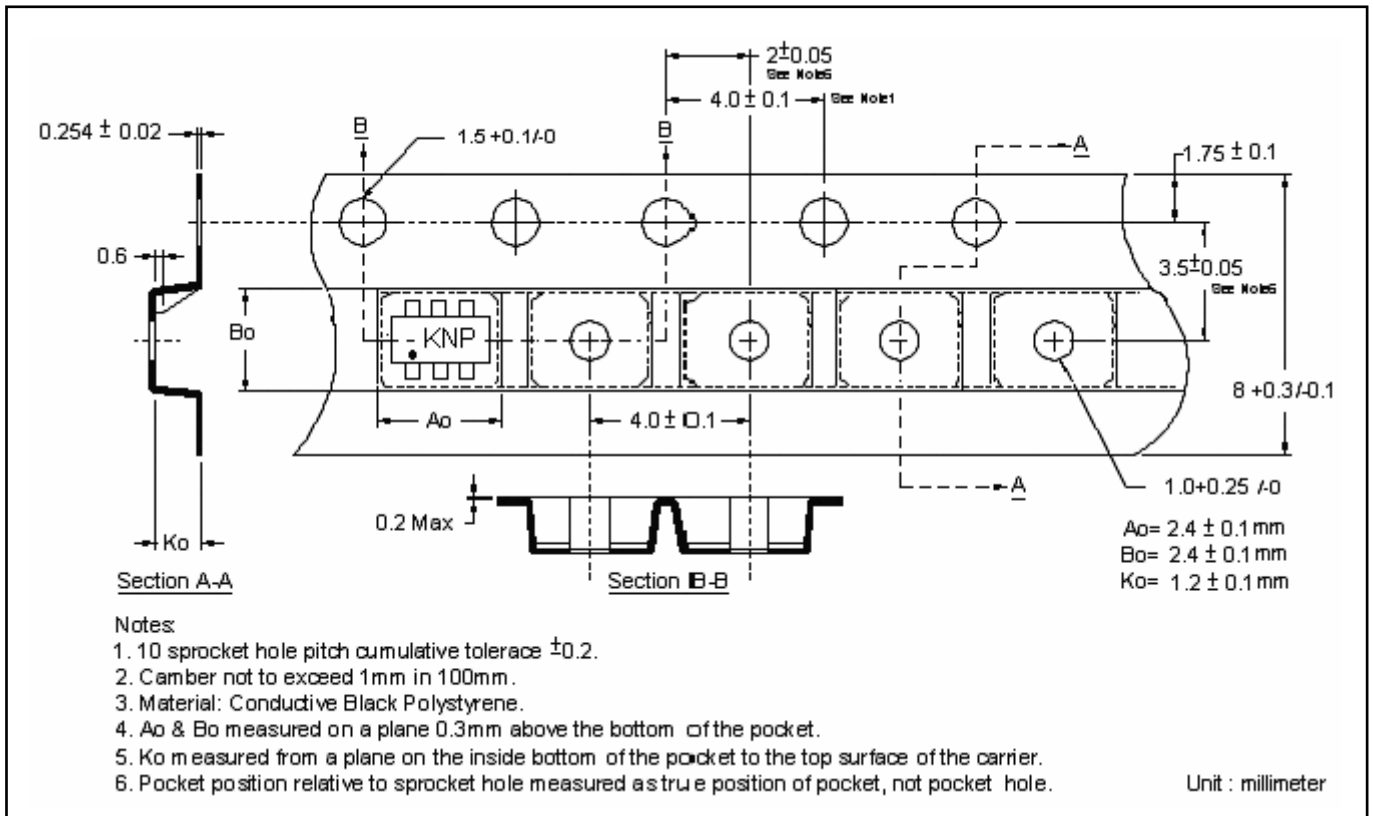

Recommended wave soldering condition

Product	Peak Temperature	Soldering Time
Pb-free devices	260 +0/-5 °C	5 +1/-1 seconds

Recommended temperature profile for IR reflow

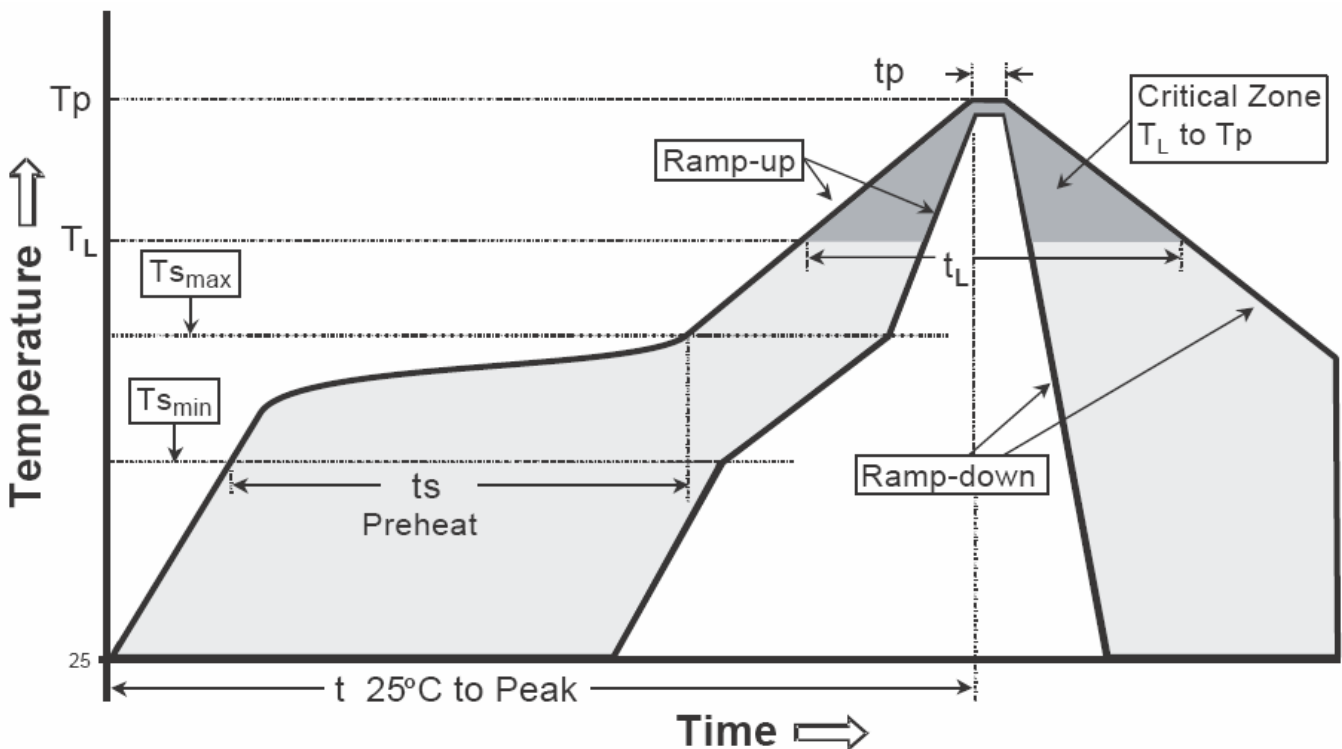

Profile feature	Sn-Pb eutectic Assembly	Pb-free Assembly
Average ramp-up rate (T _{smax} to T _p)	3°C/second max.	3°C/second max.
Preheat		
-Temperature Min(T _{s min})	100°C	150°C
-Temperature Max(T _{s max})	150°C	200°C
-Time(t _{s min} to t _{s max})	60-120 seconds	60-180 seconds
Time maintained above:		
-Temperature (T _L)	183°C	217°C
- Time (t _L)	60-150 seconds	60-150 seconds
Peak Temperature(T _P)	240 +0/-5 °C	260 +0/-5 °C
Time within 5°C of actual peak temperature(tp)	10-30 seconds	20-40 seconds
Ramp down rate	6°C/second max.	6°C/second max.
Time 25 °C to peak temperature	6 minutes max.	8 minutes max.

Note : All temperatures refer to topside of the package, measured on the package body surface.

SOT-363 Dimension

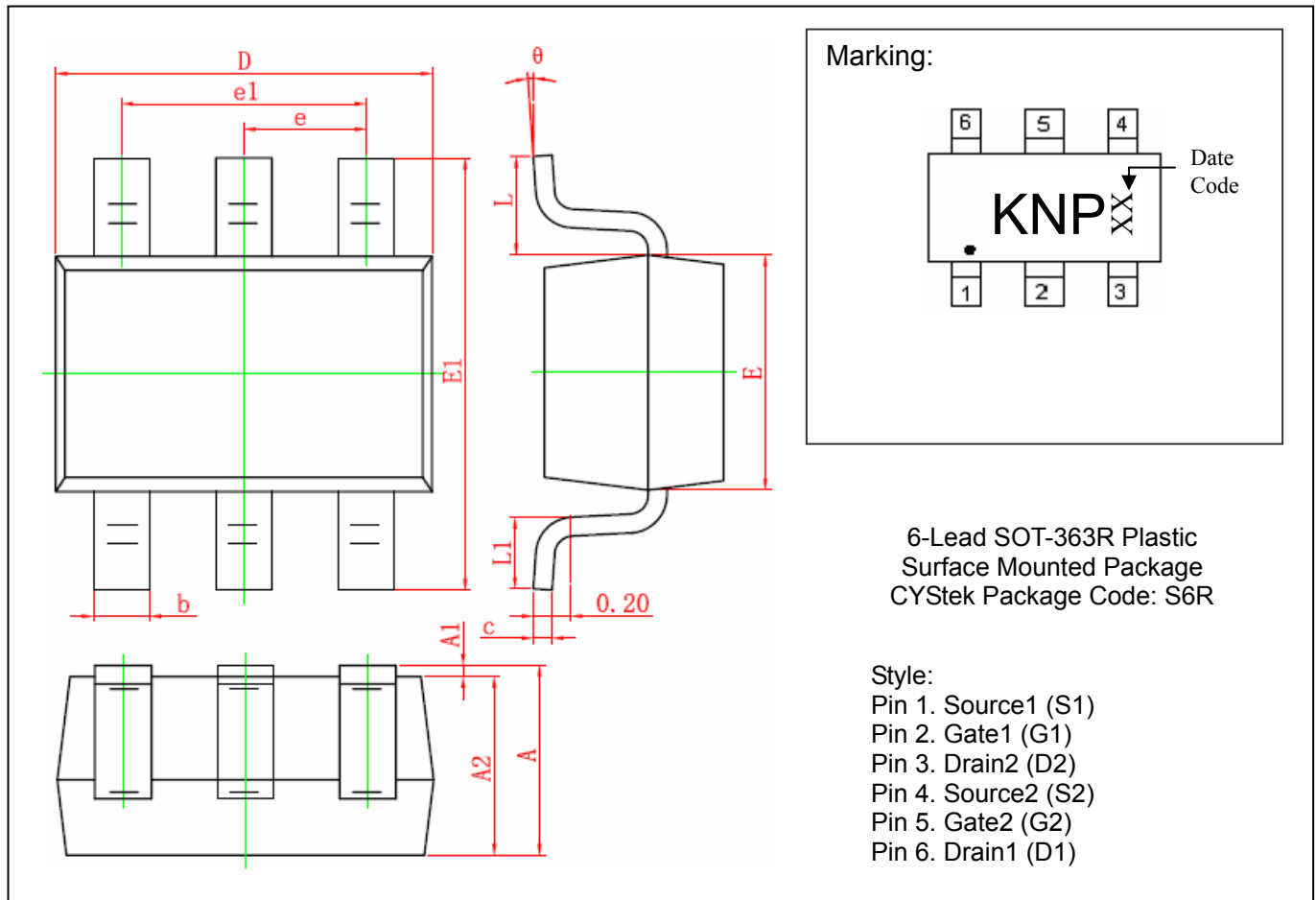

DIM	Millimeters		Inches		DIM	Millimeters		Inches	
	Min.	Max.	Min.	Max.		Min.	Max.	Min.	Max.
A	0.900	1.100	0.035	0.043	E1	2.150	2.450	0.085	0.096
A1	0.000	0.100	0.000	0.004	e	0.650	TYP	0.026	TYP
A2	0.900	1.000	0.035	0.039	e1	1.200	1.400	0.047	0.055
b	0.150	0.350	0.006	0.014	L	0.525	REF	0.021	REF
c	0.080	0.150	0.003	0.006	L1	0.260	0.460	0.010	0.018
D	2.000	2.200	0.079	0.087	θ	0°	8°	0°	8°
E	1.150	1.350	0.045	0.053					

Notes : 1.Controlling dimension : millimeters.
 2.Maximum lead thickness includes lead finish thickness, and minimum lead thickness is the minimum thickness of base material.
 3.If there is any question with packing specification or packing method, please contact your local CYStek sales office.

Material :

- Lead : Pure tin plated.
- Mold Compound : Epoxy resin family, flammability solid burning class:UL94V-0.

Important Notice:

- All rights are reserved. Reproduction in whole or in part is prohibited without the prior written approval of CYStek.
- CYStek reserves the right to make changes to its products without notice.
- CYStek **semiconductor products are not warranted to be suitable for use in Life-Support Applications, or systems.**
- CYStek assumes no liability for any consequence of customer product design, infringement of patents, or application assistance.