

**N- AND P-Channel Enhancement Mode Power MOSFET**

# MTC5806AQ8

**Features**

- Low On Resistance
- Low Gate Charge
- Fast Switching Characteristic

|                                     | N-CH | P-CH |
|-------------------------------------|------|------|
| $BV_{DSS}$                          | 60V  | -60V |
| $I_D@V_{GS}=(-)10V, T_C=25^\circ C$ | 8.8A | -6A  |
| $I_D@V_{GS}=(-)10V, T_A=25^\circ C$ | 4.3A | -3A  |
| $R_{DS(ON) typ. @V_{GS}=(-)10V}$    | 36mΩ | 88mΩ |
| $R_{DS(ON) typ. @V_{GS}=(-)4.5V}$   | 41mΩ | 98mΩ |

**Equivalent Circuit**

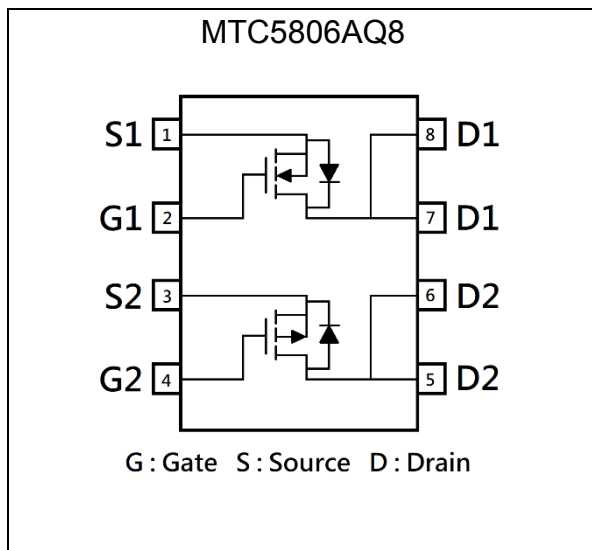

**Outline**

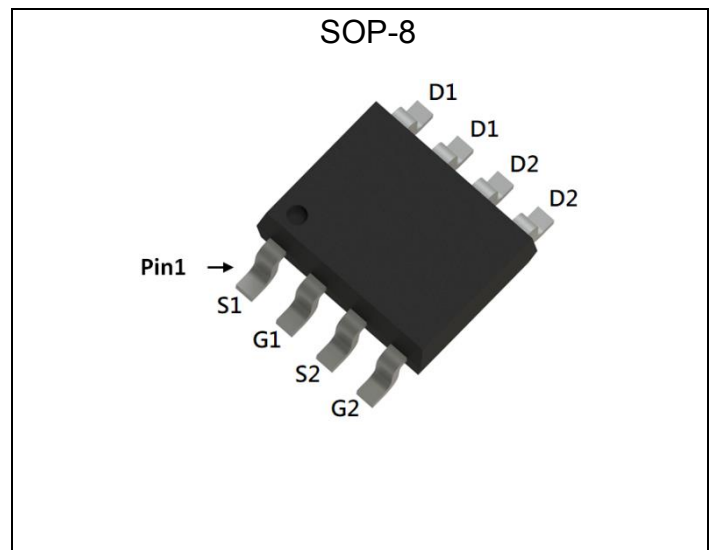

**Ordering Information**

| Device            | Package  | Shipping               |
|-------------------|--|------------------------|
| MTC5806AQ8-0-TF-G | SOP-8<br>(RoHS compliant & Halogen-free package) | 4000 pcs / Tape & Reel |

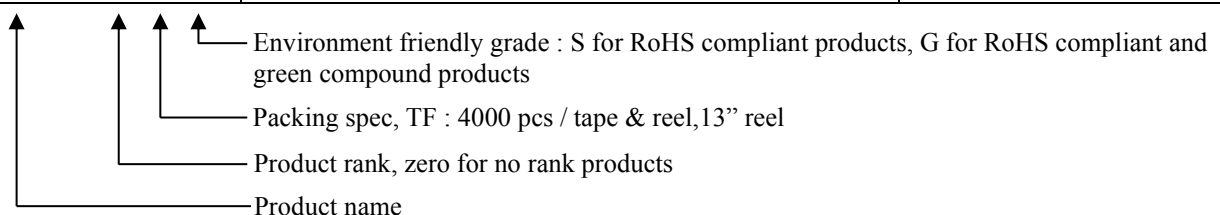



**Absolute Maximum Ratings (TA=25°C)**

| Parameter   | Symbol                | Limits                            |          | Unit |    |
|---|-----------------------|-----------------------------------|----------|------|----|
|   |                       | N-CH                              | P-CH     |      |    |
| Drain-Source Voltage  | V <sub>DS</sub>       | 60                                | -60      | V    |    |
| Gate-Source Voltage   | V <sub>GS</sub>       | ±20                               | ±20      |      |    |
| Continuous Drain Current @ V <sub>GS</sub> =(-)10V, T <sub>C</sub> =25°C  | *a                    | I <sub>D</sub>                    | 8.8      | -6   | A  |
| Continuous Drain Current @ V <sub>GS</sub> =(-)10V, T <sub>C</sub> =100°C | *a                    |                                   | 5.5      | -3.8 |    |
| Continuous Drain Current @ V <sub>GS</sub> =(-)10V, T <sub>A</sub> =25°C  | *b                    |                                   | 4.3      | -3   |    |
| Continuous Drain Current @ V <sub>GS</sub> =(-)10V, T <sub>A</sub> =70°C  | *b                    |                                   | 3.4      | -2.4 |    |
| Pulsed Drain Current  | *c                    | I <sub>DM</sub>                   | 35       | -24  |    |
| Continuous Body Diode Forward Current @ T <sub>C</sub> =25°C              | *a                    | I <sub>S</sub>                    | 6        | -6   |    |
| Avalanche Current @ L=0.1mH   |                       | I <sub>AS</sub>                   | 10       | -13  |    |
| Avalanche Energy @ L=0.5mH  |                       | E <sub>AS</sub>                   | 9        | 25   | mJ |
| Total Power Dissipation   | T <sub>C</sub> =25°C  | P <sub>D</sub>                    | 7.3      |      | W  |
|   | T <sub>C</sub> =100°C |                                   | 2.9      |      |    |
|   | T <sub>A</sub> =25°C  |                                   | 1.8      |      |    |
|   | T <sub>A</sub> =70°C  |                                   | 1.1      |      |    |
| Operating Junction and Storage Temperature Range                          |                       | T <sub>J</sub> , T <sub>stg</sub> | -55~+150 |      | °C |

**Thermal Data**

| Parameter                               | Symbol              | Steady State | Unit |
|---|---------------------|--------------|------|
| Thermal Resistance, Junction-to-case    | R <sub>θJC</sub>    | 17           | °C/W |
| Thermal Resistance, Junction-to-ambient | *b R <sub>θJA</sub> | 71           |      |

Note:

- \*a. The power dissipation P<sub>D</sub> is based on T<sub>J(MAX)</sub>=150°C, using junction-to-case thermal resistance, and is more useful in setting the upper dissipation limit for cases where additional heatsinking is used.
- \*b. The value of R<sub>θJA</sub> is measured with the device mounted on 1 in<sup>2</sup> FR-4 board with 2 oz. copper, in a still air environment with T<sub>A</sub>=25°C. The power dissipation P<sub>D</sub> is based on R<sub>θJA</sub> and the maximum allowed junction temperature of 150°C. The value in any given application depends on the user's specific board design.
- \*c. Repetitive rating, pulse width limited by junction temperature T<sub>J(MAX)</sub>=150°C. Ratings are based on low frequency and low duty cycles to keep initial T<sub>J</sub>=25°C.



**N-Channel Electrical Characteristics (T<sub>A</sub>=25°C, unless otherwise specified)**

| Symbol                    | Min. | Typ. | Max. | Unit | Test Conditions   |
|---------------------------|------|------|------|------|---|
| <b>Static</b>             |      |      |      |      |   |
| BV <sub>DSS</sub>         | 60   | -    | -    | V    | V <sub>GS</sub> =0V, I <sub>D</sub> =250μA  |
| V <sub>GS(th)</sub>       | 1    | -    | 2.5  |      | V <sub>DS</sub> =V <sub>GS</sub> , I <sub>D</sub> =250μA                            |
| G <sub>FS</sub>           | -    | 6    | -    | S    | V <sub>DS</sub> =10V, I <sub>D</sub> =4A  |
| I <sub>GSS</sub>          | -    | -    | ±100 | nA   | V <sub>GS</sub> =±20V, V <sub>DS</sub> =0V  |
| I <sub>DSS</sub>          | -    | -    | 1    | μA   | V <sub>DS</sub> =48V, V <sub>GS</sub> =0V   |
| R <sub>DS(ON)</sub>       | -    | 36   | 47   | mΩ   | V <sub>GS</sub> =10V, I <sub>D</sub> =4A  |
|                           | -    | 41   | 57   |      | V <sub>GS</sub> =4.5V, I <sub>D</sub> =3A   |
| <b>Dynamic</b>            |      |      |      |      |   |
| C <sub>iss</sub>          | -    | 730  | -    | pF   | V <sub>DS</sub> =30V, V <sub>GS</sub> =0V, f=1MHz                                   |
| C <sub>oss</sub>          | -    | 45   | -    |      |   |
| C <sub>rss</sub>          | -    | 37   | -    |      |   |
| R <sub>g</sub>            | -    | 2.8  | -    | Ω    | f=1MHz  |
| Q <sub>g</sub> *1, 2      | -    | 18   | -    | nC   | V <sub>DS</sub> =30V, I <sub>D</sub> =5A, V <sub>GS</sub> =10V                      |
| Q <sub>gs</sub> *1, 2     | -    | 2.1  | -    |      |   |
| Q <sub>gd</sub> *1, 2     | -    | 3.8  | -    |      |   |
| t <sub>d(ON)</sub> *1, 2  | -    | 6.5  | -    | ns   | V <sub>DS</sub> =30V, I <sub>D</sub> =2A, V <sub>GS</sub> =10V, R <sub>GS</sub> =6Ω |
| t <sub>r</sub> *1, 2      | -    | 7.4  | -    |      |   |
| t <sub>d(OFF)</sub> *1, 2 | -    | 41   | -    |      |   |
| t <sub>f</sub> *1, 2      | -    | 6.3  | -    |      |   |
| <b>Source-Drain Diode</b> |      |      |      |      |   |
| V <sub>SD</sub> *1        | -    | 0.85 | 1.2  | V    | I <sub>S</sub> =5A, V <sub>GS</sub> =0V   |
| t <sub>rr</sub>           | -    | 12   | -    | ns   | I <sub>F</sub> =5A, dI <sub>F</sub> /dt=100A/μs                                     |
| Q <sub>rr</sub>           | -    | 7.5  | -    | nC   |   |

Note:

\*1. Pulse Test : Pulse Width ≤300μs, Duty Cycle≤2%

\*2. Independent of operating temperature



**P-Channel Electrical Characteristics (T<sub>A</sub>=25°C, unless otherwise specified)**

| Symbol                    | Min. | Typ. | Max. | Unit | Test Conditions  |
|---------------------------|------|------|------|------|--|
| <b>Static</b>             |      |      |      |      |  |
| BV <sub>DSS</sub>         | -60  | -    | -    | V    | V <sub>GS</sub> =0V, I <sub>D</sub> =-250μA  |
| V <sub>GS(th)</sub>       | -1   | -    | -2.5 |      | V <sub>DS</sub> =V <sub>GS</sub> , I <sub>D</sub> =-250μA                              |
| G <sub>FS</sub>           | -    | 5    | -    | S    | V <sub>DS</sub> =-10V, I <sub>D</sub> =-3A   |
| I <sub>GSS</sub>          | -    | -    | ±100 | nA   | V <sub>GS</sub> =±20V, V <sub>DS</sub> =0V   |
| I <sub>DSS</sub>          | -    | -    | -1   | μA   | V <sub>DS</sub> =-48V, V <sub>GS</sub> =0V   |
| R <sub>DS(ON)</sub>       | -    | 88   | 110  | mΩ   | V <sub>GS</sub> =-10V, I <sub>D</sub> =-3A   |
|                           | -    | 98   | 135  |      | V <sub>GS</sub> =-4.5V, I <sub>D</sub> =-2A  |
| <b>Dynamic</b>            |      |      |      |      |  |
| C <sub>iss</sub>          | -    | 1000 | -    | pF   | V <sub>DS</sub> =-30V, V <sub>GS</sub> =0V, f=1MHz                                     |
| C <sub>oss</sub>          | -    | 50   | -    |      |  |
| C <sub>rss</sub>          | -    | 42   | -    |      |  |
| R <sub>g</sub>            | -    | 15   | -    | Ω    | f=1MHz   |
| Q <sub>g</sub> *1, 2      | -    | 20   | -    | nC   | V <sub>DS</sub> =-30V, I <sub>D</sub> =-2A, V <sub>GS</sub> =-10V                      |
| Q <sub>gs</sub> *1, 2     | -    | 3.3  | -    |      |  |
| Q <sub>gd</sub> *1, 2     | -    | 3.8  | -    |      |  |
| t <sub>d(ON)</sub> *1, 2  | -    | 8    | -    | ns   | V <sub>DS</sub> =-30V, I <sub>D</sub> =-2A, V <sub>GS</sub> =-10V, R <sub>GS</sub> =3Ω |
| t <sub>r</sub> *1, 2      | -    | 17   | -    |      |  |
| t <sub>d(OFF)</sub> *1, 2 | -    | 50   | -    |      |  |
| t <sub>f</sub> *1, 2      | -    | 12   | -    |      |  |
| <b>Source-Drain Diode</b> |      |      |      |      |  |
| V <sub>SD</sub> *1        | -    | -0.8 | -1.2 | V    | I <sub>S</sub> =-2A, V <sub>GS</sub> =0V   |
| t <sub>rr</sub>           | -    | 14   | -    | ns   | I <sub>F</sub> =-2A, dI <sub>F</sub> /dt=100A/μs                                       |
| Q <sub>rr</sub>           | -    | 10   | -    | nC   |  |

Note:

\*1. Pulse Test : Pulse Width ≤300μs, Duty Cycle≤2%

\*2. Independent of operating temperature



**Typical Characteristics : Q1( N-channel )**

Typical Output Characteristics

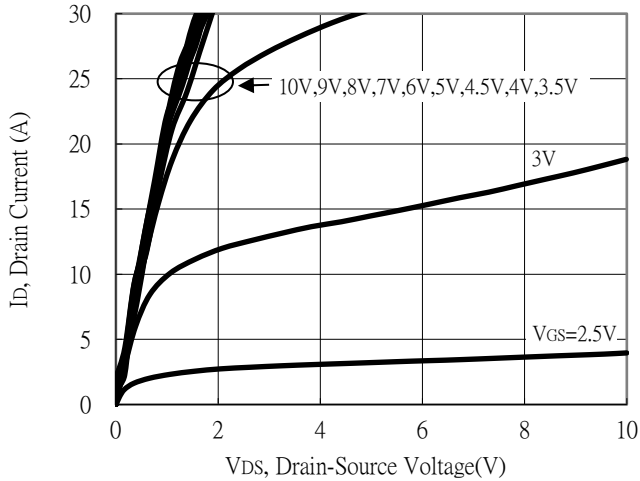

Breakdown Voltage vs Ambient Temperature

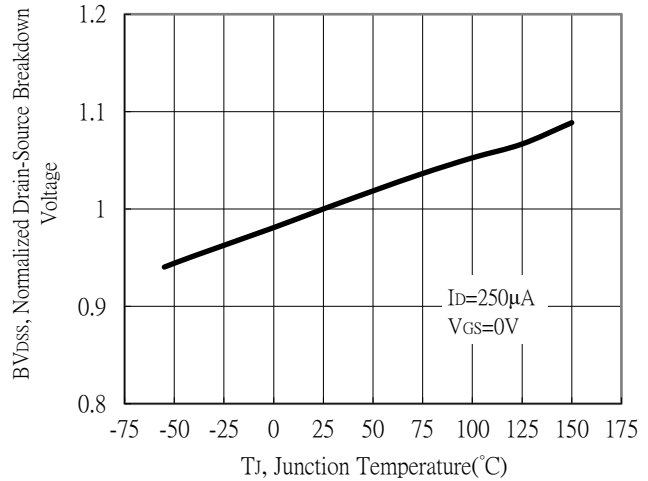

Static Drain-Source On-State resistance vs Drain Current

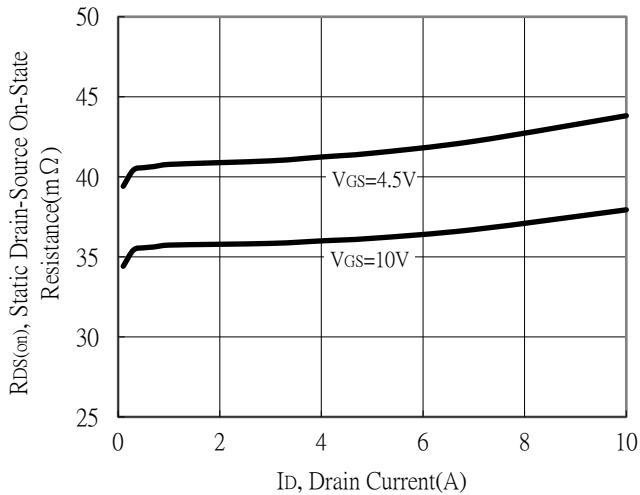

Body Diode Current vs Source-Drain Voltage

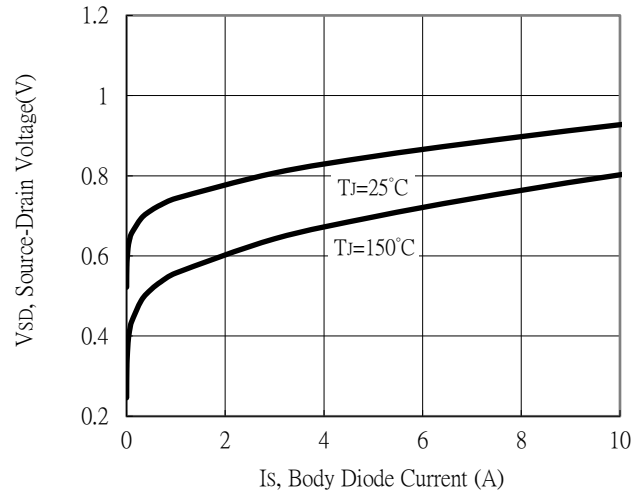

Static Drain-Source On-State Resistance vs Gate-Source Voltage

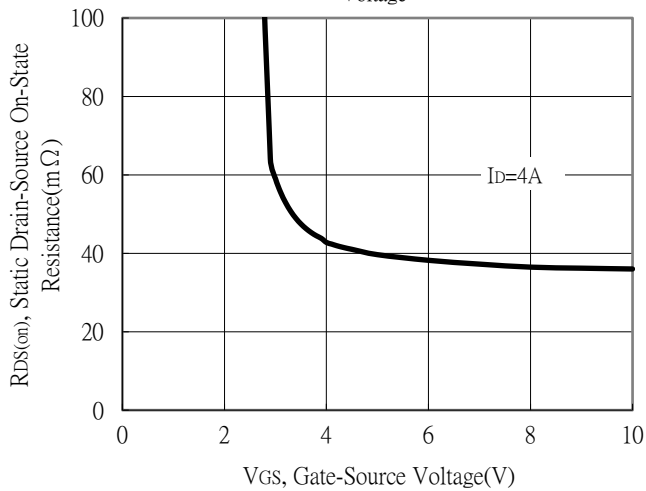

Drain-Source On-State Resistance vs Junction Temperature

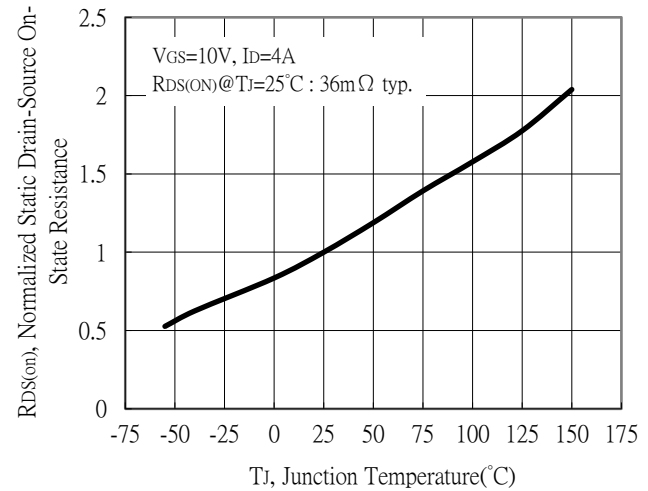



**Typical Characteristics (Cont.) : Q1( N-channel)**

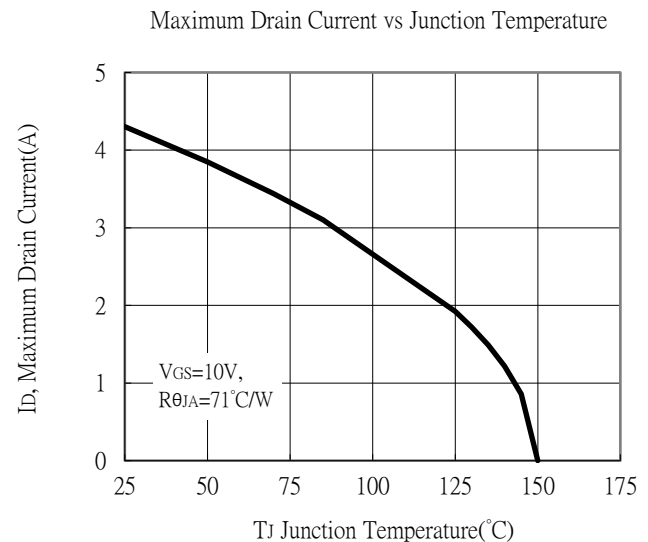
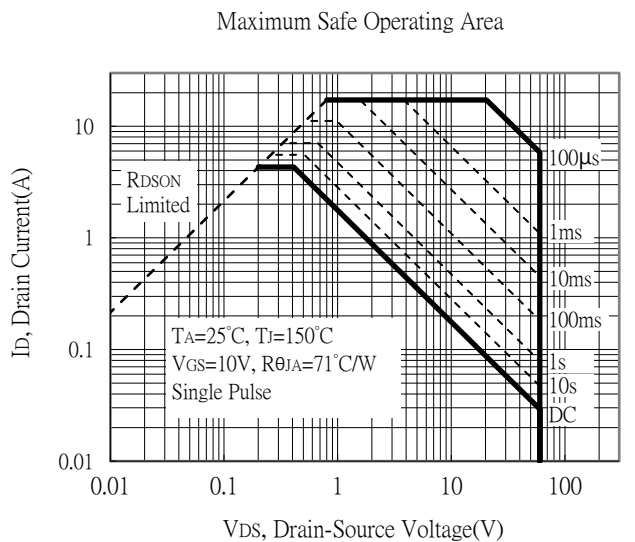
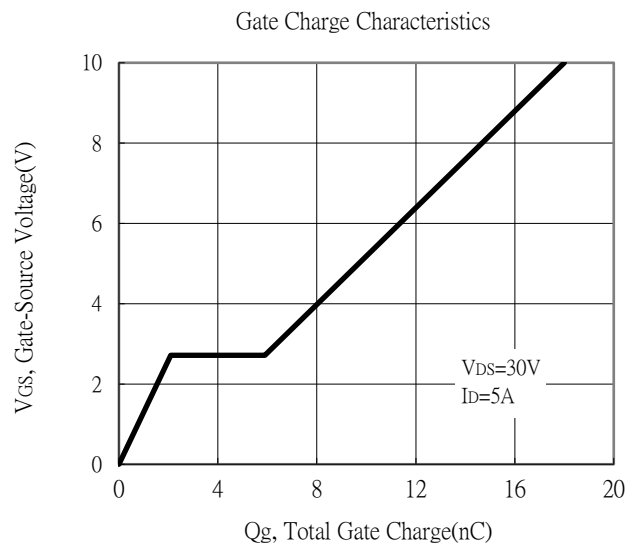
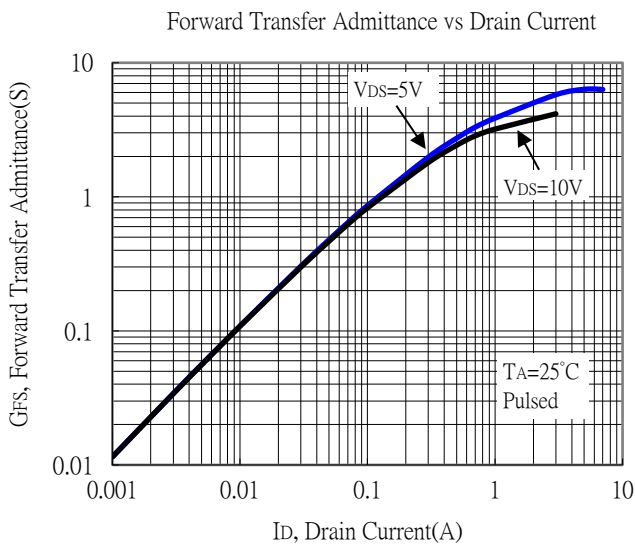
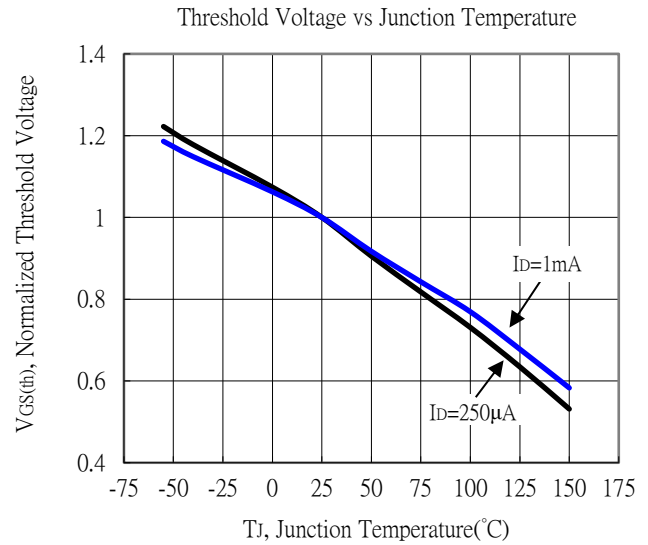
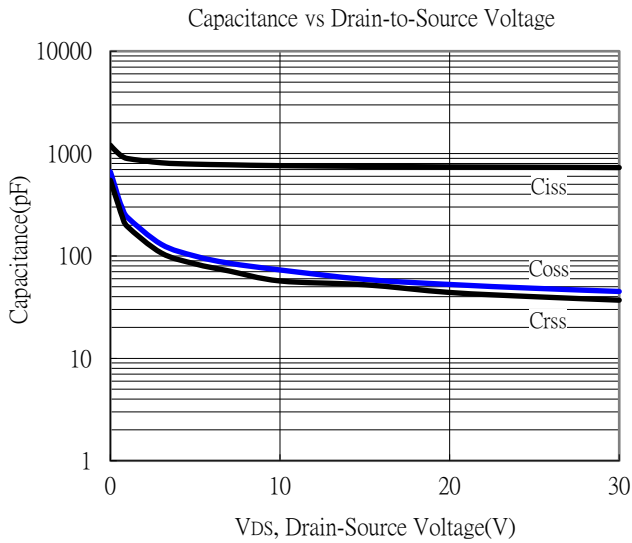



**Typical Characteristics (Cont.) : Q1( N-channel)**

Single Pulse Power Rating, Junction to Ambient

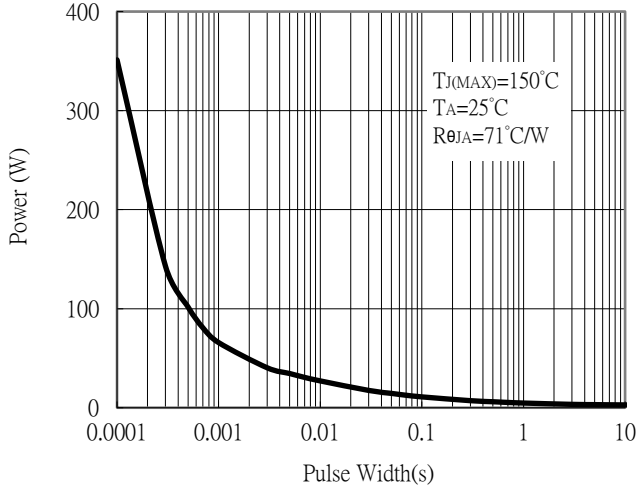

Transient Thermal Response Curves

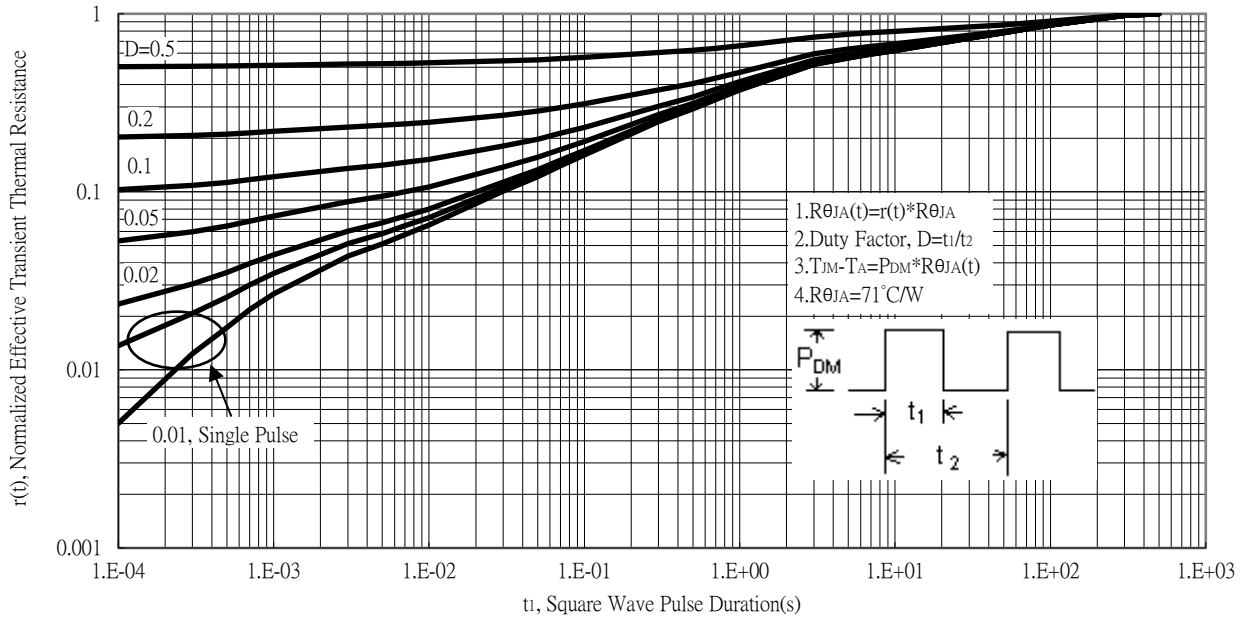

## Typical Characteristics : Q2( P-channel)

Typical Output Characteristics

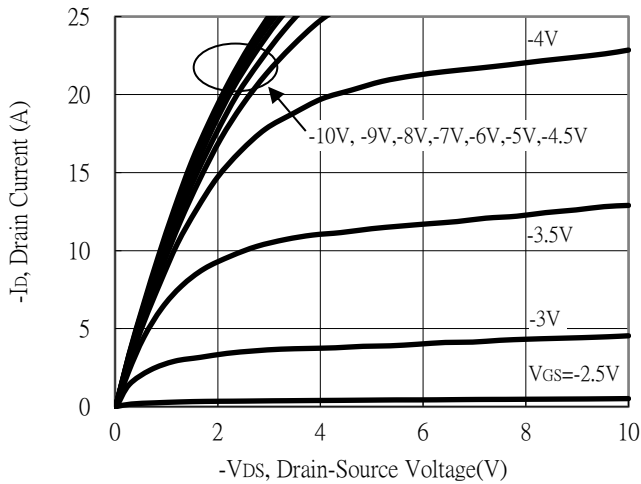

Breakdown Voltage vs Ambient Temperature

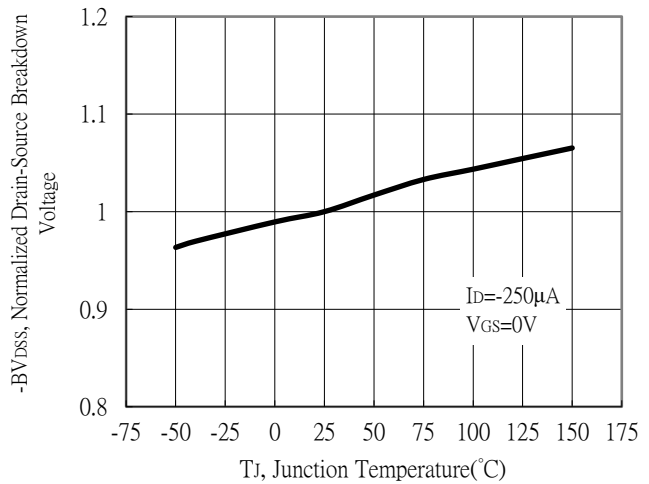

Static Drain-Source On-State resistance vs Drain Current

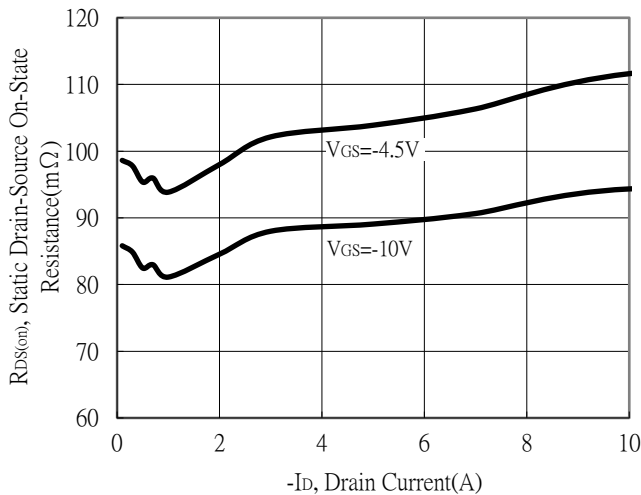

Body Diode Current vs Source-Drain Voltage

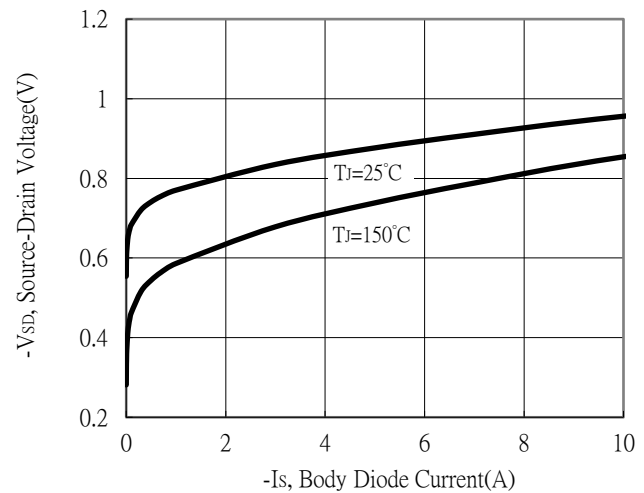

Static Drain-Source On-State Resistance vs Gate-Source Voltage

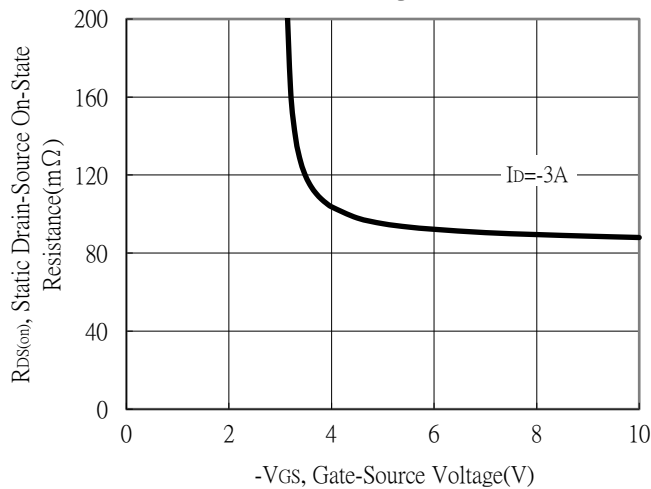

Drain-Source On-State Resistance vs Junction Temperature

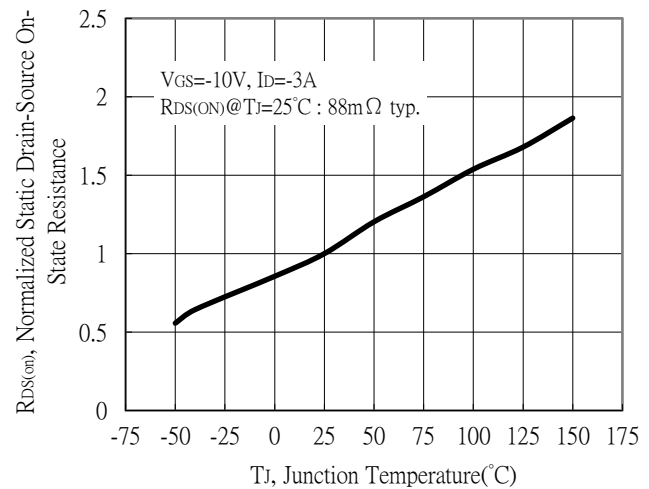



**Typical Characteristics (Cont.) : Q2(P-channel)**

Capacitance vs Drain-to-Source Voltage

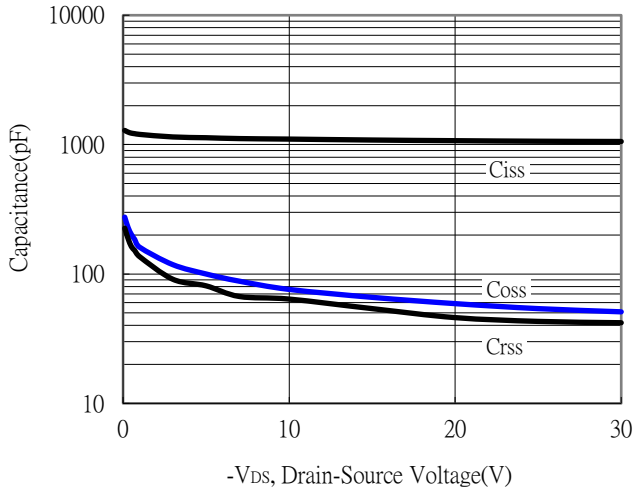

Threshold Voltage vs Junction Temperature

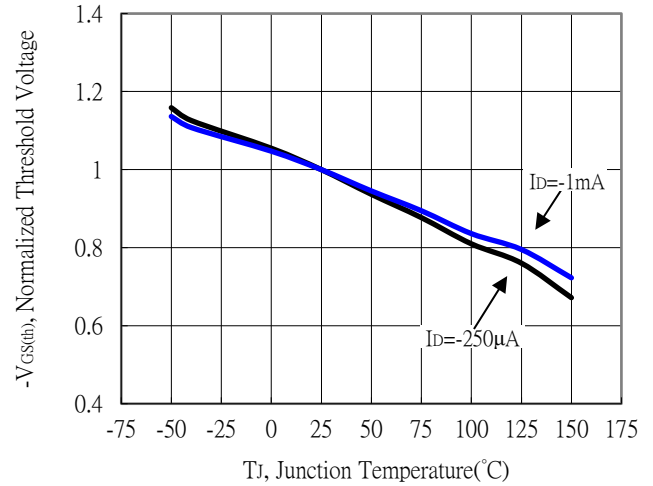

Forward Transfer Admittance vs Drain Current

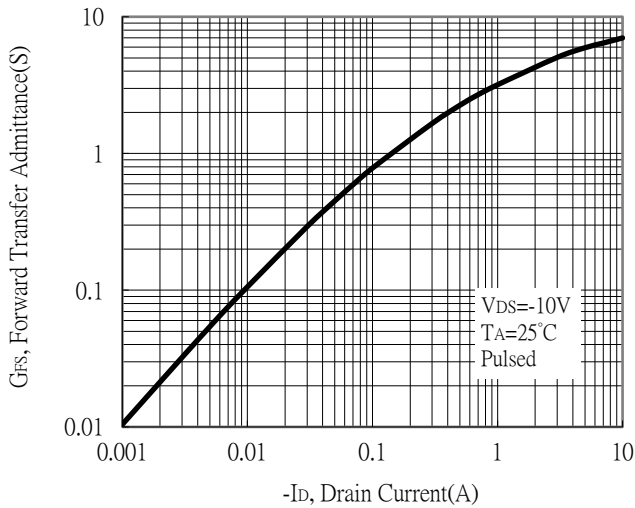

Gate Charge Characteristics

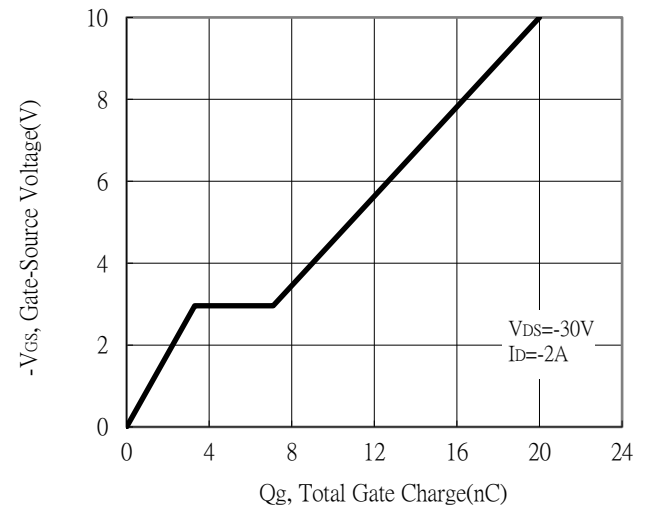

Maximum Safe Operating Area

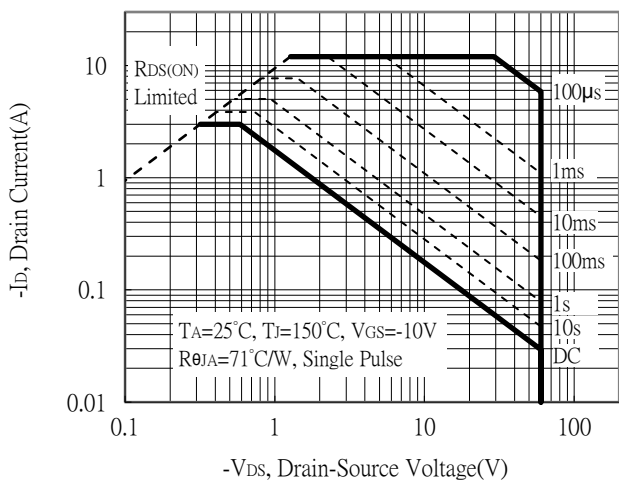

Maximum Drain Current vs Junction Temperature

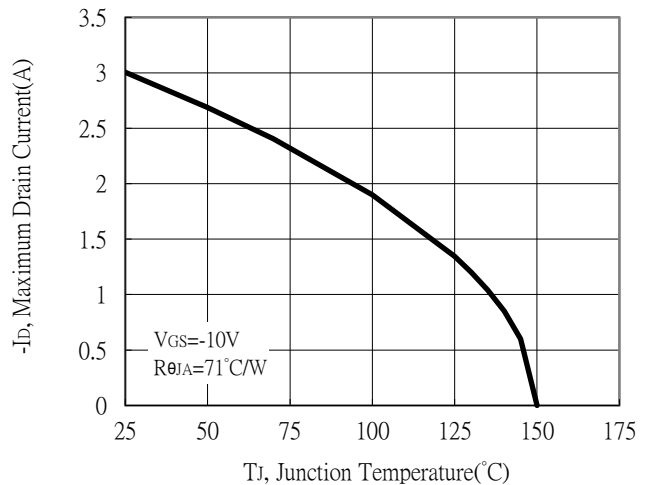

**Typical Characteristics (Cont.) : Q2(P-channel)**

Single Pulse Power Rating, Junction to Ambient

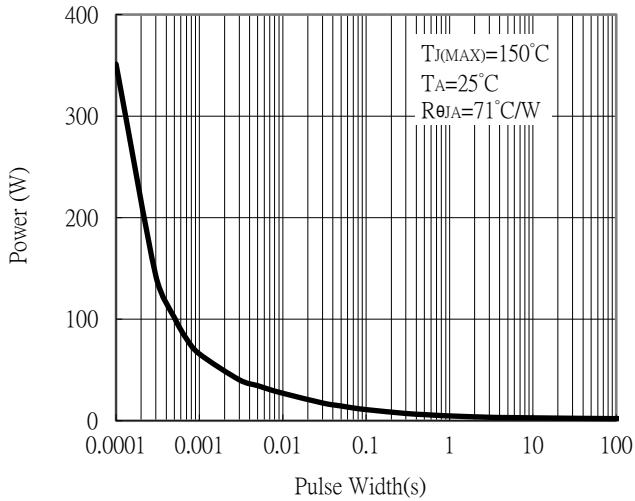

Transient Thermal Response Curves

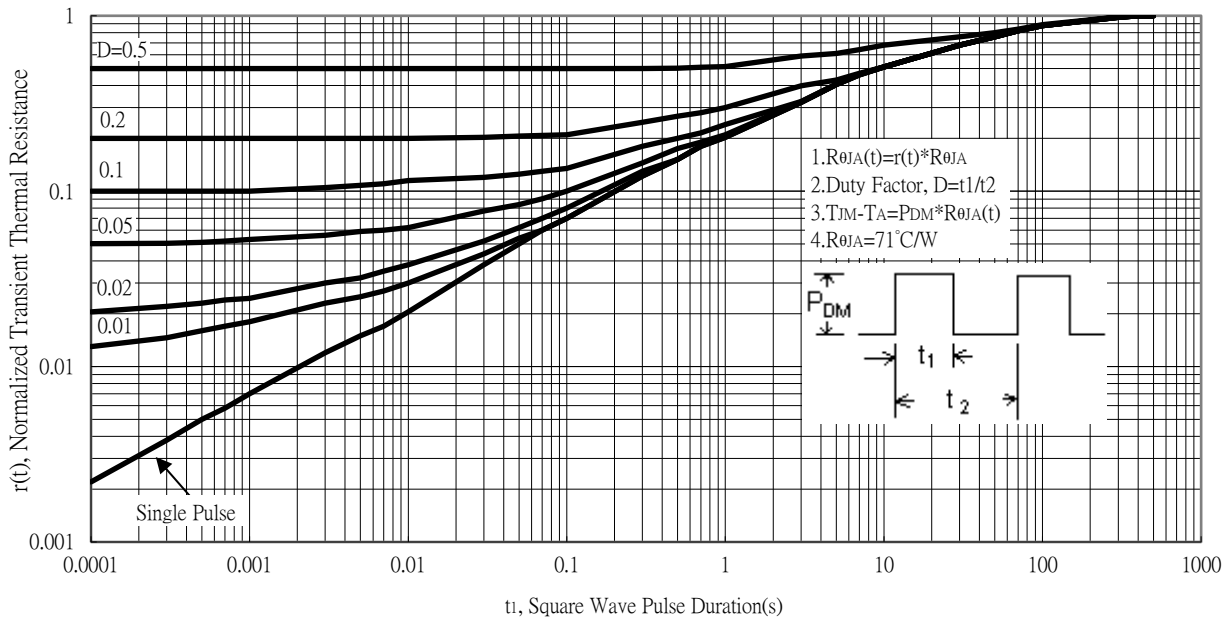

**Recommended Soldering Footprint**

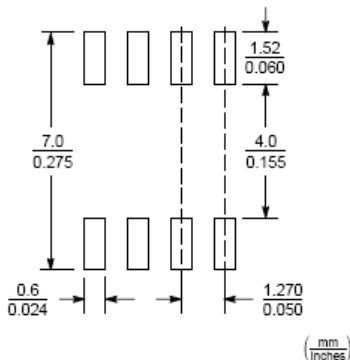

### Reel Dimension

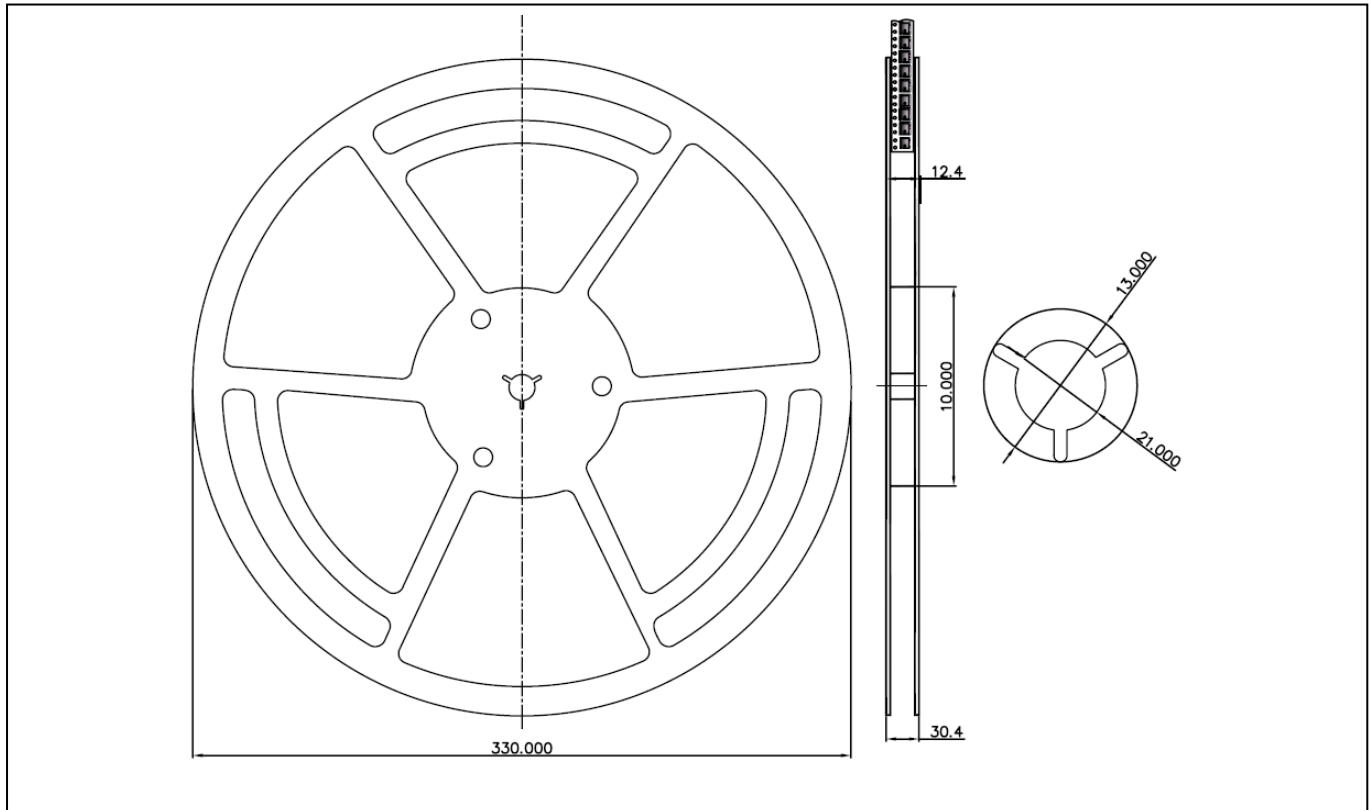

### Carrier Tape Dimension

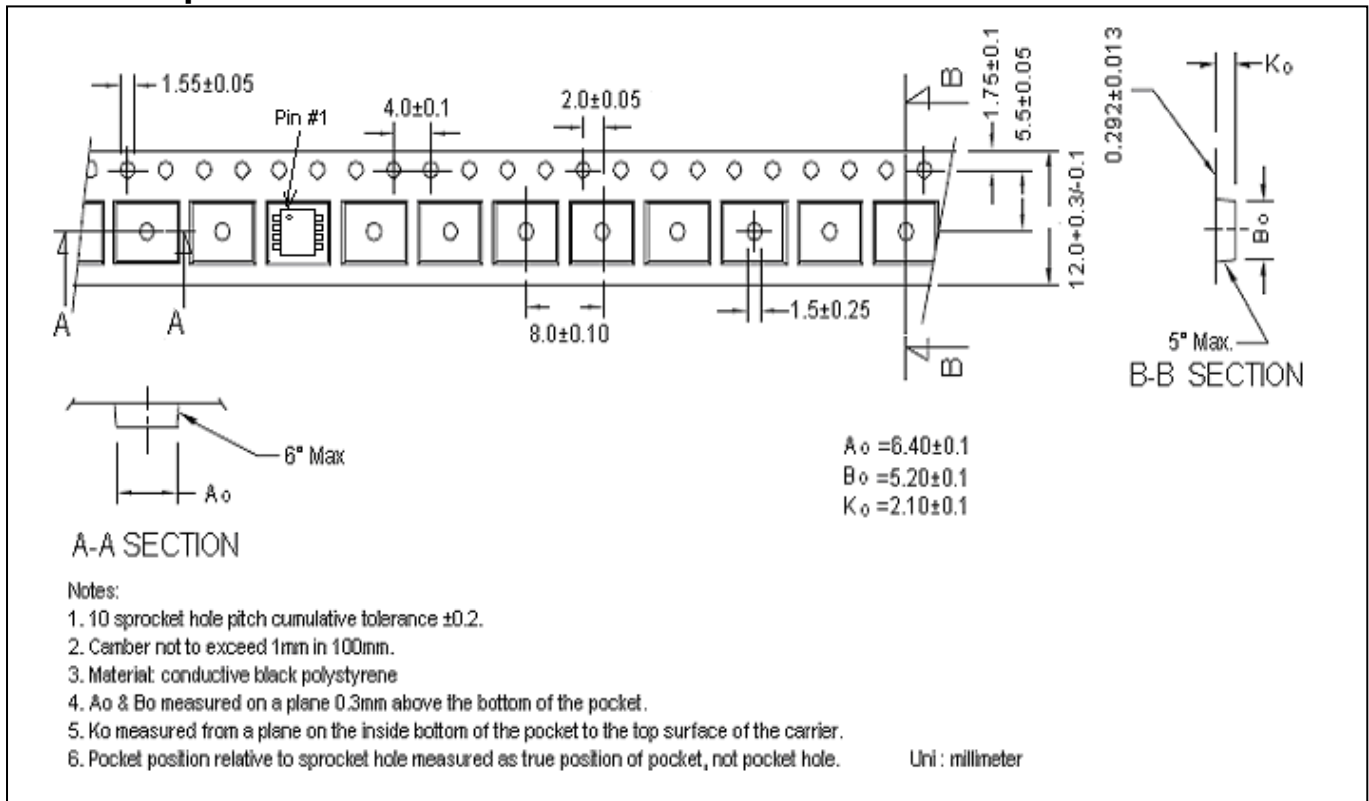

**Recommended wave soldering condition**

|                 |                  |                 |
|-----------------|------------------|-----------------|
| Product         | Peak Temperature | Soldering Time  |
| Pb-free devices | 260 +0/-5 °C     | 5 +1/-1 seconds |

**Recommended temperature profile for IR reflow**

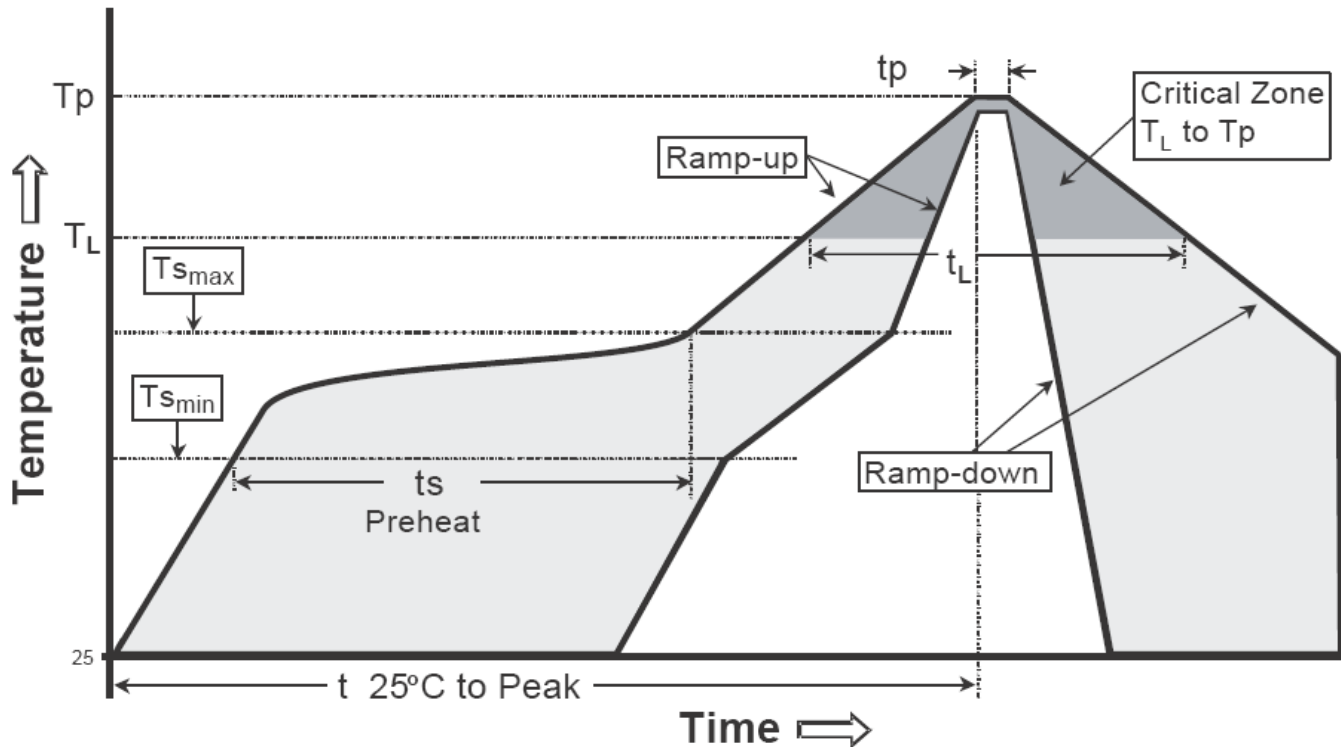

| Profile feature   | Sn-Pb eutectic Assembly | Pb-free Assembly |
|---|-------------------------|------------------|
| Average ramp-up rate (T <sub>smax</sub> to T <sub>p</sub> ) | 3°C/second max.         | 3°C/second max.  |
| Preheat   |                         |                  |
| -Temperature Min(T <sub>s min</sub> )                       | 100°C                   | 150°C            |
| -Temperature Max(T <sub>s max</sub> )                       | 150°C                   | 200°C            |
| -Time(t <sub>s min</sub> to t <sub>s max</sub> )            | 60-120 seconds          | 60-180 seconds   |
| Time maintained above:                                      |                         |                  |
| -Temperature (T <sub>L</sub> )                              | 183°C                   | 217°C            |
| - Time (t <sub>L</sub> )                                    | 60-150 seconds          | 60-150 seconds   |
| Peak Temperature(T <sub>P</sub> )                           | 240 +0/-5 °C            | 260 +0/-5 °C     |
| Time within 5°C of actual peak temperature(tp)              | 10-30 seconds           | 20-40 seconds    |
| Ramp down rate  | 6°C/second max.         | 6°C/second max.  |
| Time 25 °C to peak temperature                              | 6 minutes max.          | 8 minutes max.   |

Note : All temperatures refer to topside of the package, measured on the package body surface.

**SOP-8 Dimension**

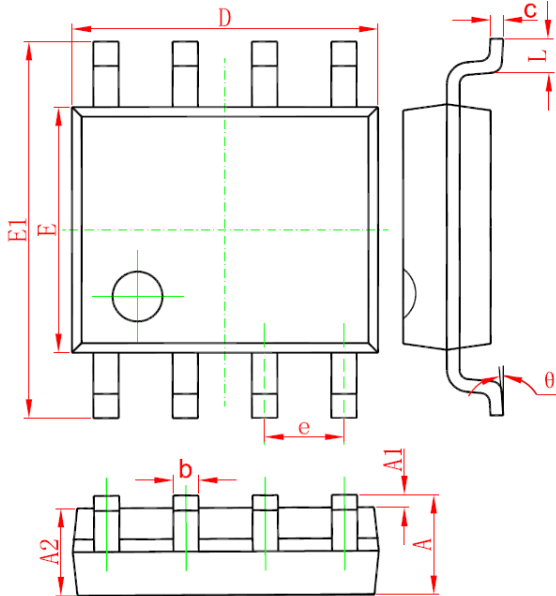

8-Lead SOP-8 Plastic Package  
 CYStek Package Code: Q8

**Marking:**

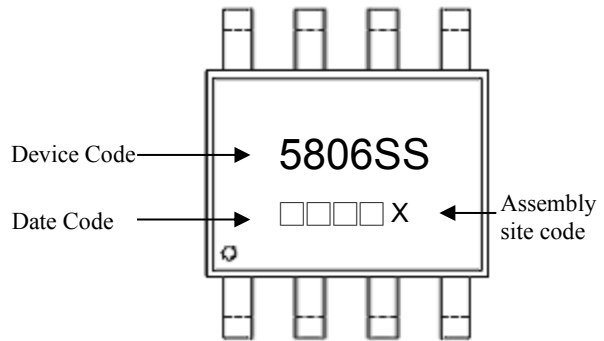

Date Code(counting from left to right) :  
 1<sup>st</sup> code: year code, the last digit of Christian year  
 2<sup>nd</sup> code : month code, Jan→A, Feb→B, Mar→C, Apr→D  
 May→E, Jun→F, Jul→G, Aug→H, Sep→J,  
 Oct→K, Nov→L, Dec→M  
 3<sup>rd</sup> and 4<sup>th</sup> codes : production serial number, 01~99

Assembly site code : blank→ site 1, G →site 2

\*: Typical

| DIM | Millimeters |       | Inches |       | DIM | Millimeters |       | Inches |       |
|-----|-------------|-------|--------|-------|-----|-------------|-------|--------|-------|
|     | Min.        | Max.  | Min.   | Max.  |     | Min.        | Max.  | Min.   | Max.  |
| A   | 1.350       | 1.750 | 0.053  | 0.069 | E   | 3.800       | 4.000 | 0.150  | 0.157 |
| A1  | 0.100       | 0.250 | 0.004  | 0.010 | E1  | 5.800       | 6.200 | 0.228  | 0.244 |
| A2  | 1.350       | 1.550 | 0.053  | 0.061 | e   | *1.270      |       | *0.050 |       |
| b   | 0.330       | 0.510 | 0.013  | 0.020 | L   | 0.400       | 1.270 | 0.016  | 0.050 |
| c   | 0.170       | 0.250 | 0.006  | 0.010 | θ   | 0°          | 8°    | 0°     | 8°    |
| D   | 4.700       | 5.100 | 0.185  | 0.200 |     |             |       |        |       |

- Notes:** 1.Controlling dimension: millimeters.  
 2.Maximum lead thickness includes lead finish thickness, and minimum lead thickness is the minimum thickness of base material.  
 3.If there is any question with packing specification or packing method, please contact your local CYStek sales office.

**Material:**

- Lead: Pure tin plated.
- Mold Compound: Epoxy resin family, flammability solid burning class: UL94V-0.

**Important Notice:**

- All rights are reserved. Reproduction in whole or in part is prohibited without the prior written approval of CYStek.
- CYStek reserves the right to make changes to its products without notice.
- CYStek **semiconductor products are not warranted to be suitable for use in Life-Support Applications, or systems.**
- CYStek assumes no liability for any consequence of customer product design, infringement of patents, or application assistance.