

**N- AND P-Channel Enhancement Mode MOSFET**

# MTC2605G6

	N-CH	P-CH
$BV_{DSS}$	20V	-20V
$I_D$	5A( $V_{GS}=4.5V$ )	-2.9A( $V_{GS}=-4.5V$ )
$R_{DSON(TYP.)}$	23m $\Omega$ ( $V_{GS}=4.5V$ )	79m $\Omega$ ( $V_{GS}=-4.5V$ )
	30m $\Omega$ ( $V_{GS}=2.5V$ )	117m $\Omega$ ( $V_{GS}=-2.5V$ )
	46m $\Omega$ ( $V_{GS}=1.8V$ )	160m $\Omega$ ( $V_{GS}=-1.8V$ )

## Description

The MTC2605G6 consists of a N-channel and a P-channel enhancement-mode MOSFET in a single TSOP-6 package, providing the designer with the best combination of fast switching, ruggedized device design, low on-resistance and cost-effectiveness.

The TSOP-6 package is universally preferred for all commercial-industrial surface mount applications.

## Features

- Simple drive requirement
- Low gate charge
- Low on-resistance
- Fast switching speed
- Pb-free lead plating and halogen-free package

## Equivalent Circuit

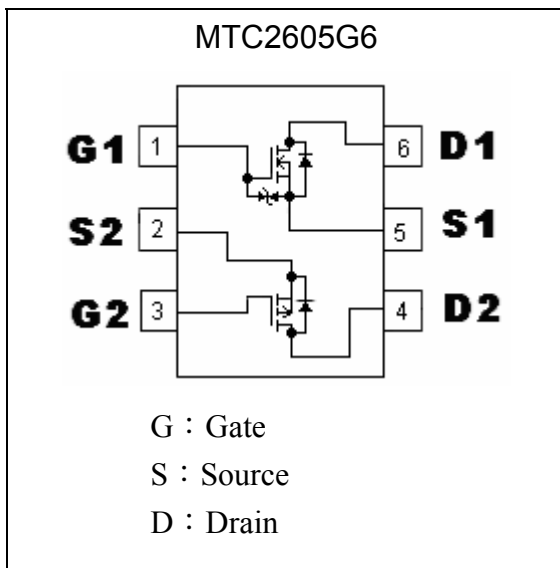

## Outline

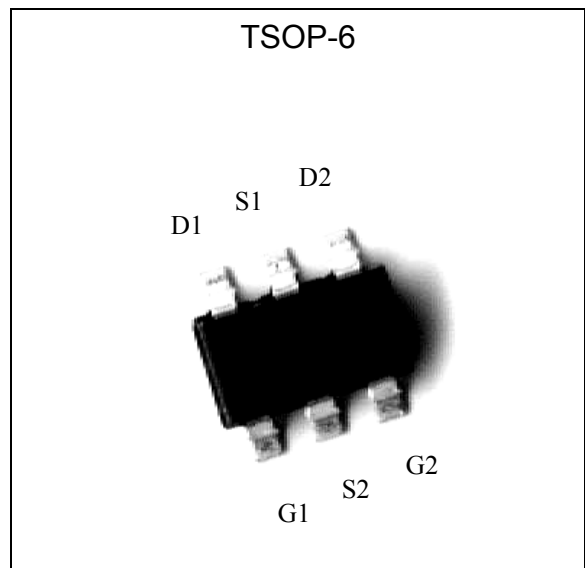



**Absolute Maximum Ratings (Ta=25°C)**

Parameter		Symbol	Limits		Unit
			N-channel	P-channel	
Drain-Source Breakdown Voltage		BV <sub>DSS</sub>	20	-20	V
Gate-Source Voltage		V <sub>GS</sub>	±8	±8	V
Continuous Drain Current (Note 1)	T <sub>A</sub> =25°C, V <sub>GS</sub> =4.5V(N-CH), V <sub>GS</sub> =-4.5V(P-CH)	I <sub>D</sub>	5	-2.9	A
	T <sub>A</sub> =70°C, V <sub>GS</sub> =4.5V(N-CH), V <sub>GS</sub> =-4.5V(P-CH)	I <sub>D</sub>	4	-2.3	A
Pulsed Drain Current (Note 2)		I <sub>DM</sub>	20	-11.6	A
Total Power Dissipation (Note 1)		P <sub>d</sub>	1.25		W
Linear Derating Factor			0.01		W / °C
Operating Junction and Storage Temperature		T <sub>j</sub> , T <sub>stg</sub>	-55~+150		°C
Thermal Resistance, Junction-to-Ambient (Note 1)		R <sub>th,ja</sub>	110		°C/W

Note : 1.Surface mounted on 1 in<sup>2</sup> copper pad of FR-4 board, t≤5 sec; 180°C/W when mounted on minimum copper pad.  
 2.Pulse width limited by maximum junction temperature.

**N-Channel Electrical Characteristics (Tj=25°C, unless otherwise specified)**

Symbol	Min.	Typ.	Max.	Unit	Test Conditions
<b>Static</b>					
BV <sub>DSS</sub>	20	-	-	V	V <sub>GS</sub> =0, I <sub>D</sub> =250μA
V <sub>GS(th)</sub>	0.4	0.6	1.2		V <sub>DS</sub> =V <sub>GS</sub> , I <sub>D</sub> =250μA
I <sub>GSS</sub>	-	-	±20	μA	V <sub>GS</sub> =±8V, V <sub>DS</sub> =0
I <sub>DSS</sub>	-	-	1		V <sub>DS</sub> =20V, V <sub>GS</sub> =0
I <sub>DSS</sub>	-	-	25		V <sub>DS</sub> =16V, V <sub>GS</sub> =0, T <sub>j</sub> =70°C
*R <sub>DSON</sub>	-	23	30	mΩ	V <sub>GS</sub> =4.5V, I <sub>D</sub> =5A
	-	30	40		V <sub>GS</sub> =2.5V, I <sub>D</sub> =2.6A
	-	46	60		V <sub>GS</sub> =1.8V, I <sub>D</sub> =2A
*G <sub>FS</sub>	-	13	-	S	V <sub>DS</sub> =5V, I <sub>D</sub> =5A
<b>Dynamic</b>					
C <sub>iss</sub>	-	509	-	pF	V <sub>DS</sub> =10V, V <sub>GS</sub> =0, f=1MHz
C <sub>oss</sub>	-	100	-		
C <sub>rss</sub>	-	81	-		
*t <sub>d(ON)</sub>	-	6	-	ns	V <sub>DS</sub> =10V, I <sub>D</sub> =1A, V <sub>GS</sub> =4.5V, R <sub>G</sub> =3.3Ω
*t <sub>r</sub>	-	19	-		
*t <sub>d(OFF)</sub>	-	12	-		
*t <sub>f</sub>	-	10	-		
*Q <sub>g</sub>	-	7	-	nC	V <sub>DS</sub> =10V, I <sub>D</sub> =5A, V <sub>GS</sub> =4.5V
*Q <sub>gs</sub>	-	0.9	-		
*Q <sub>gd</sub>	-	2.4	-		
<b>Source-Drain Diode</b>					
*V <sub>SD</sub>	-	0.77	1.2	V	V <sub>GS</sub> =0V, I <sub>S</sub> =1.2A
*t <sub>rr</sub>	-	14	-	ns	I <sub>S</sub> =5A, V <sub>GS</sub> =0V, dI/dt=100A/μs
*Q <sub>rr</sub>	-	7	-	nC	

\*Pulse Test : Pulse Width ≤300μs, Duty Cycle ≤2%



**P-Channel Electrical Characteristics** (Tj=25°C, unless otherwise specified)

Symbol	Min.	Typ.	Max.	Unit	Test Conditions
<b>Static</b>					
BV <sub>DSS</sub>	-20	-	-	V	V <sub>GS</sub> =0, I <sub>D</sub> =-250μA
V <sub>GS(th)</sub>	-0.4	-0.8	-1.2		V <sub>DS</sub> =V <sub>GS</sub> , I <sub>D</sub> =-250μA
I <sub>GSS</sub>	-	-	±100	nA	V <sub>GS</sub> =±8V, V <sub>DS</sub> =0
I <sub>DSS</sub>	-	-	-1	μA	V <sub>DS</sub> =-20V, V <sub>GS</sub> =0
I <sub>DSS</sub>	-	-	-10		V <sub>DS</sub> =-16V, V <sub>GS</sub> =0, Tj=70°C
*R <sub>DS(ON)</sub>	-	79	105	mΩ	V <sub>GS</sub> =-4.5V, I <sub>D</sub> =-2.8A
	-	117	155		V <sub>GS</sub> =-2.5V, I <sub>D</sub> =-2A
	-	160	210		V <sub>GS</sub> =-1.8V, I <sub>D</sub> =-1A
*G <sub>FS</sub>	-	6	-	S	V <sub>DS</sub> =-5V, I <sub>D</sub> =-2.8A
<b>Dynamic</b>					
C <sub>iss</sub>	-	446	-	pF	V <sub>DS</sub> =-10V, V <sub>GS</sub> =0, f=1MHz
C <sub>oss</sub>	-	57	-		
C <sub>rss</sub>	-	52	-		
*t <sub>d(ON)</sub>	-	9.2	-	ns	V <sub>DD</sub> =-10V, I <sub>D</sub> =-1A, V <sub>GS</sub> =-4.5V, R <sub>G</sub> =6Ω
*t <sub>r</sub>	-	7.3	-		
*t <sub>d(OFF)</sub>	-	38	-		
*t <sub>f</sub>	-	12	-		
*Q <sub>g</sub>	-	5	-	nC	V <sub>DS</sub> =-10V, I <sub>D</sub> =-2A, V <sub>GS</sub> =-4.5V
*Q <sub>gs</sub>	-	0.6	-		
*Q <sub>gd</sub>	-	2.5	-		
<b>Source-Drain Diode</b>					
*V <sub>SD</sub>	-	-0.86	-1.2	V	V <sub>GS</sub> =0V, I <sub>S</sub> =-1.6A
*t <sub>rr</sub>	-	26	-	ns	I <sub>S</sub> =-2.9A, V <sub>GS</sub> =0V, dI/dt=100A/μs
*Q <sub>rr</sub>	-	5	-	nC	

\*Pulse Test : Pulse Width ≤300μs, Duty Cycle ≤2%

**Ordering Information**

Device	Package	Shipping
MTC2605G6-0-T1-G	TSOP-6 (Pb-free lead plating and halogen-free package)	3000 pcs / Tape & Reel

## N-channel Typical Characteristics

Typical Output Characteristics

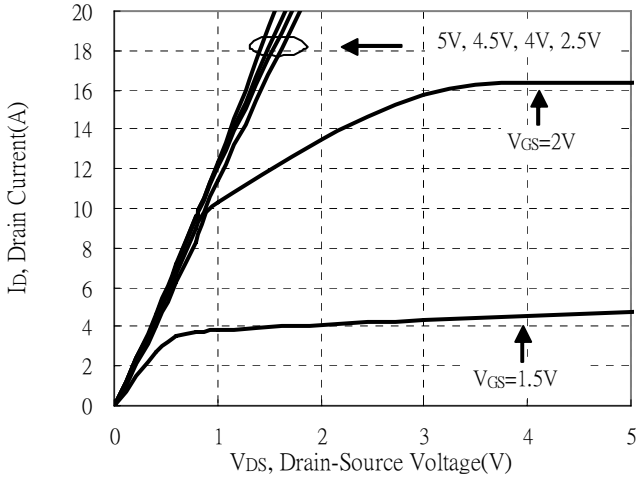

Brekdown Voltage vs Ambient Temperature

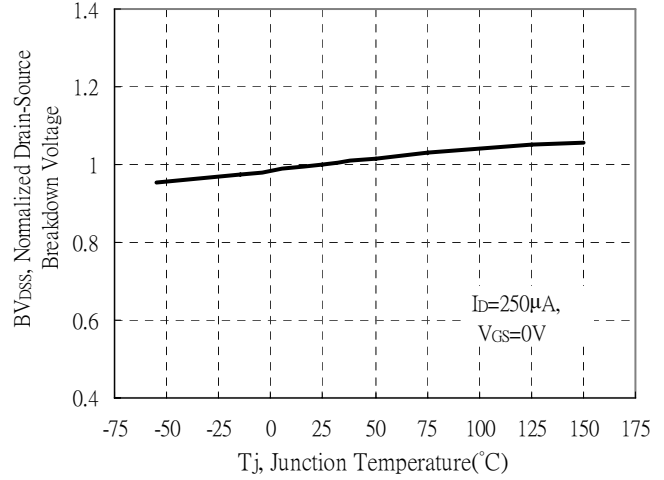

Static Drain-Source On-State resistance vs Drain Current

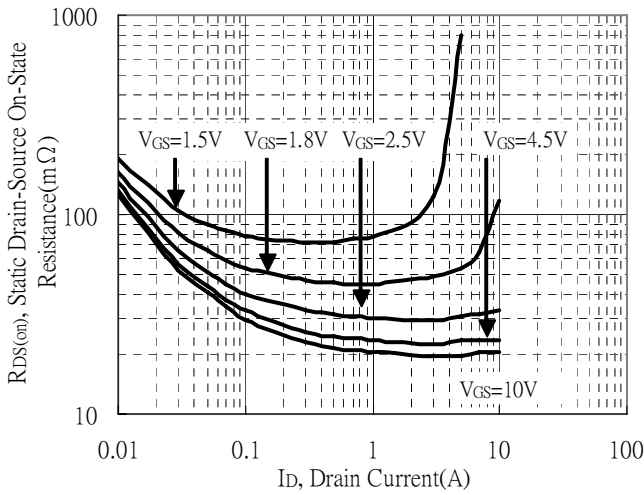

Reverse Drain Current vs Source-Drain Voltage

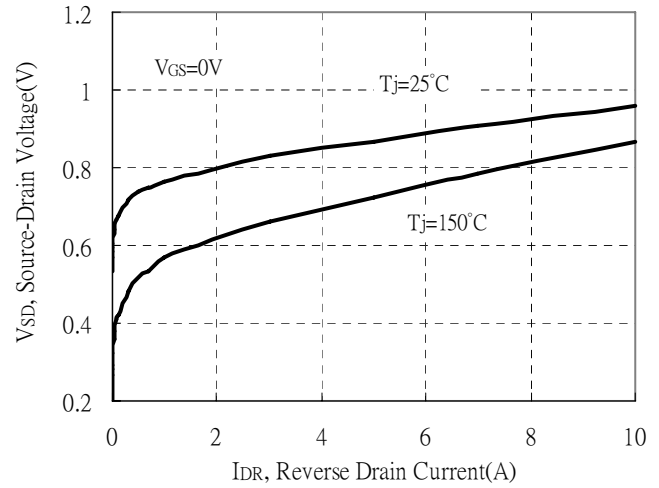

Static Drain-Source On-State Resistance vs Gate-Source Voltage

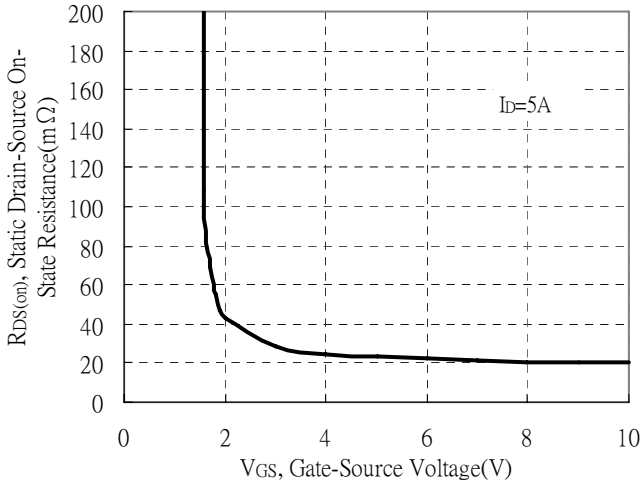

Drain-Source On-State Resistance vs Junction Temperature

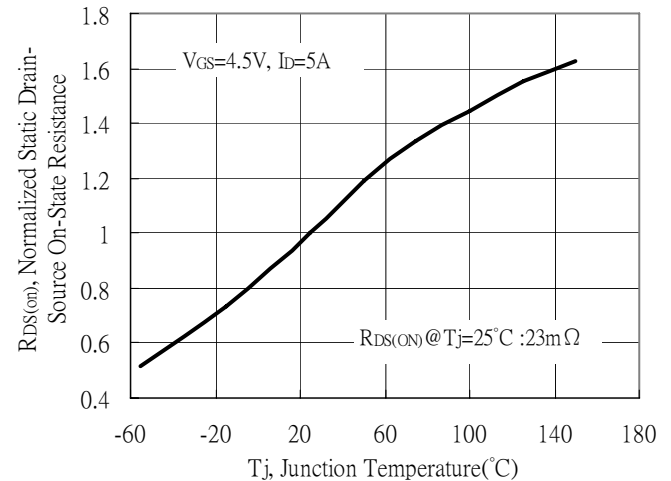

**N-channel Typical Characteristics(Cont.)**

Capacitance vs Drain-to-Source Voltage

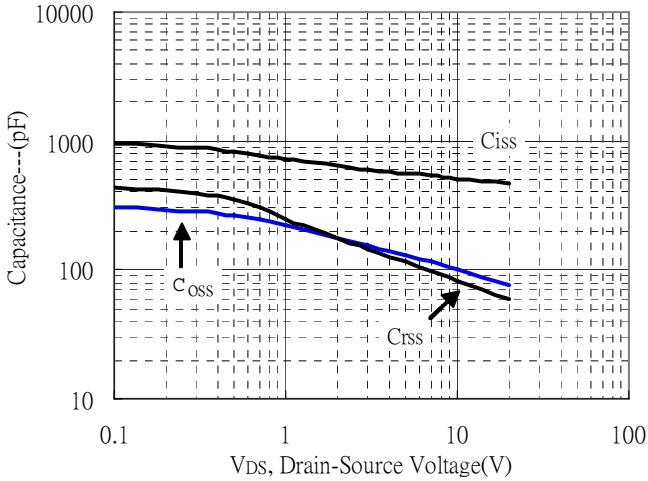

Threshold Voltage vs Junction Temperature

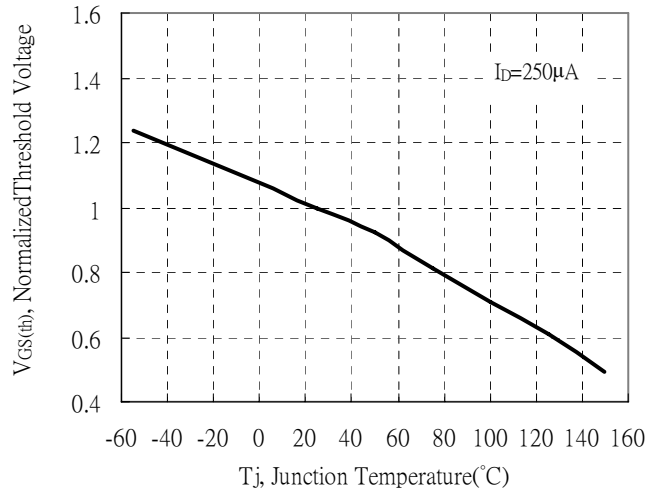

Single Pulse Power Rating, Junction to Ambient

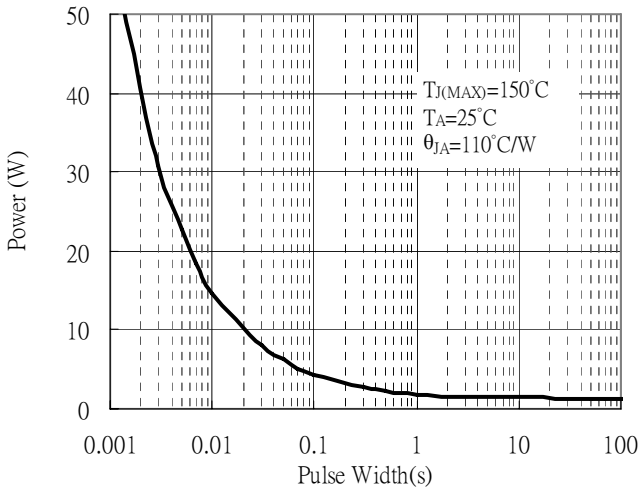

Gate Charge Characteristics

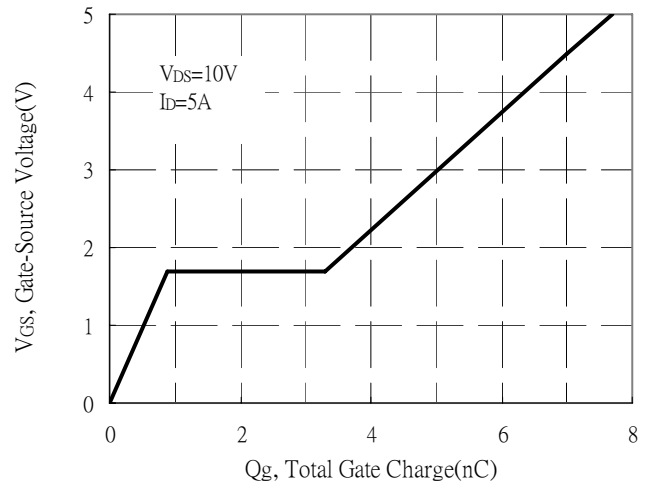

Maximum Safe Operating Area

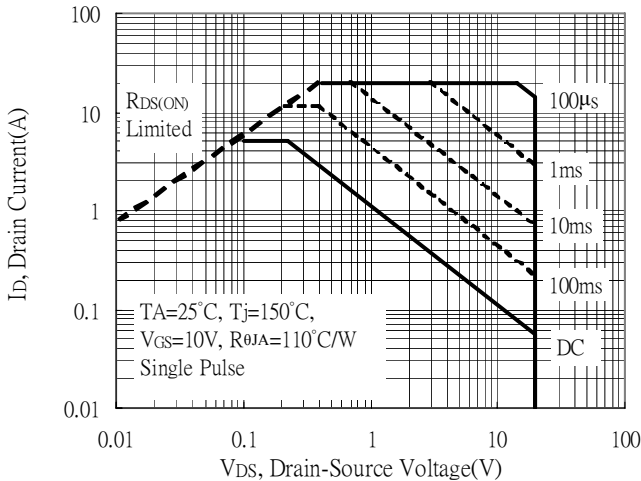

Maximum Drain Current vs Junction Temperature

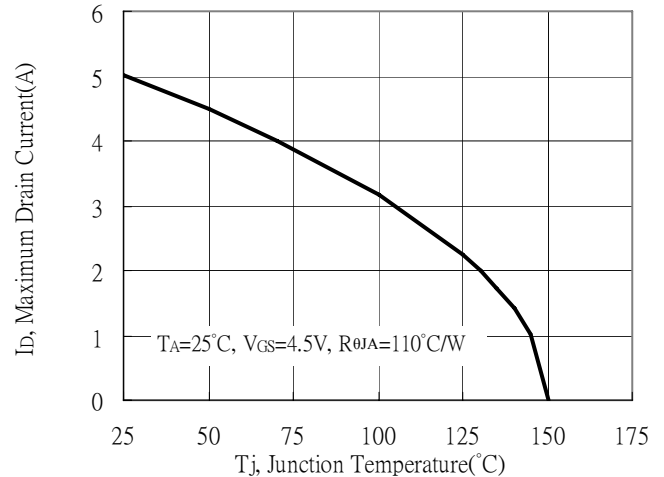



### N-channel Typical Characteristics(Cont.)

Transient Thermal Response Curves

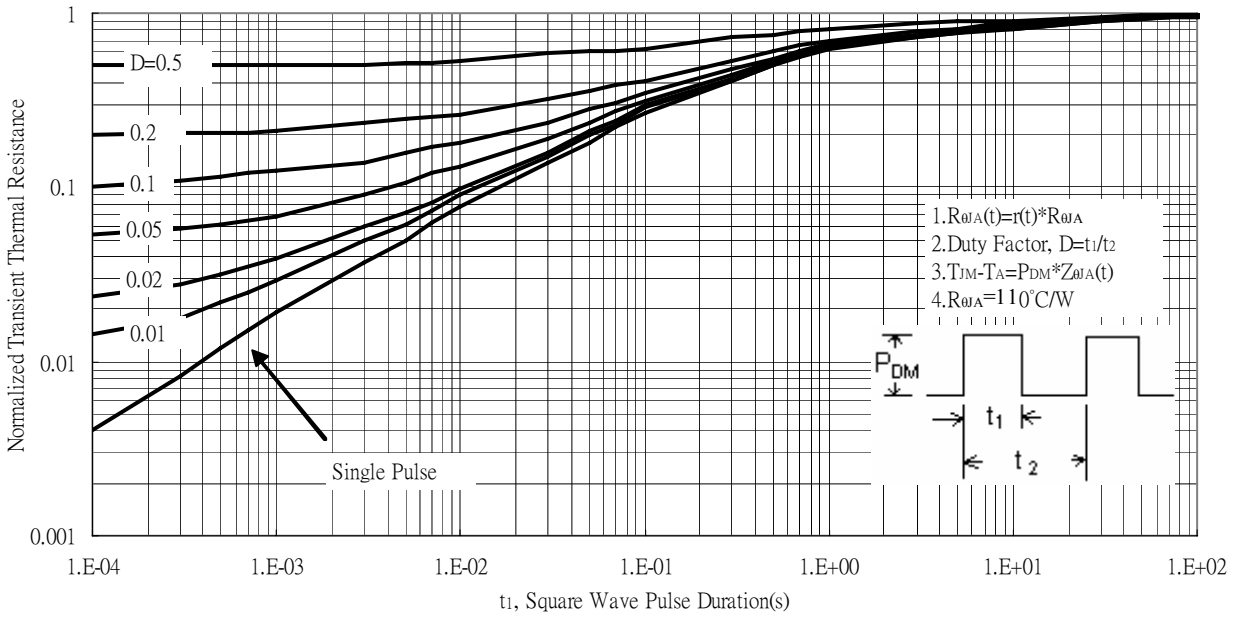

## P-channel Typical Characteristics

Typical Output Characteristics

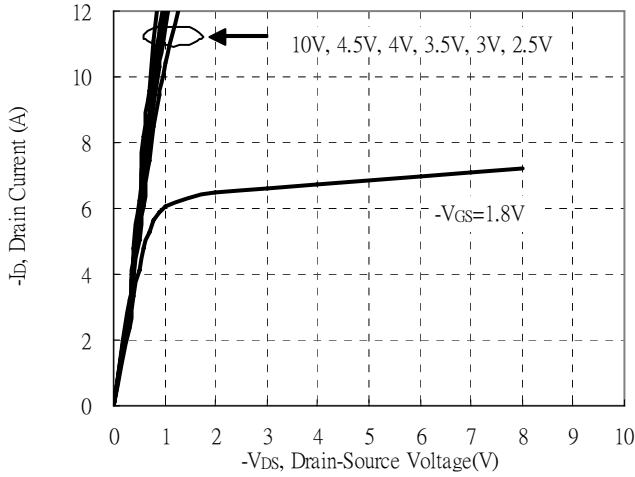

Brekdown Voltage vs Ambient Temperature

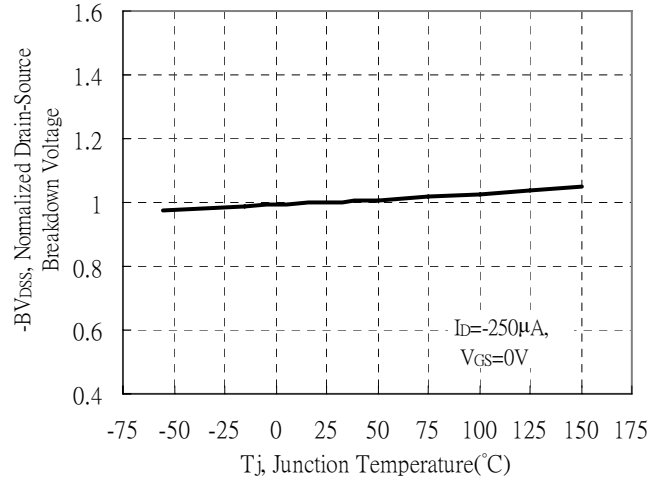

Static Drain-Source On-State resistance vs Drain Current

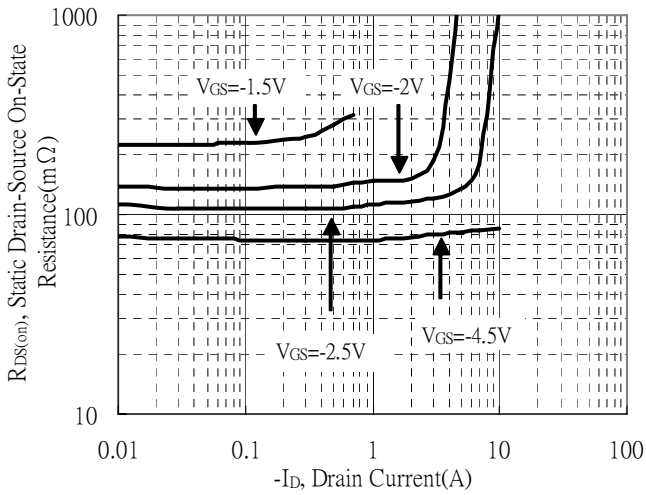

Reverse Drain Current vs Source-Drain Voltage

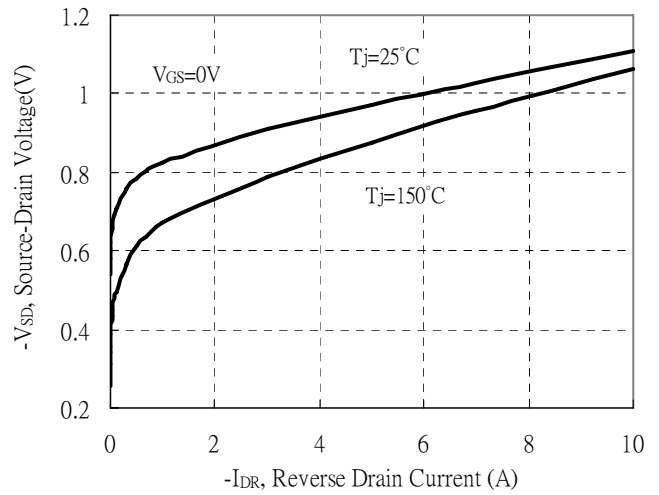

Static Drain-Source On-State Resistance vs Gate-Source Voltage

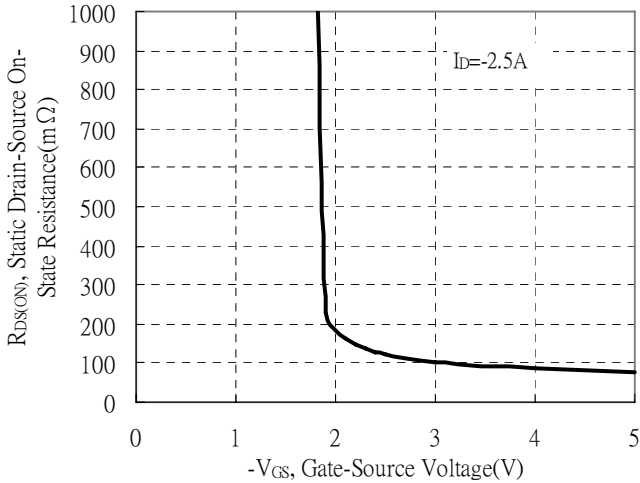

Drain-Source On-State Resistance vs Junction Temperature

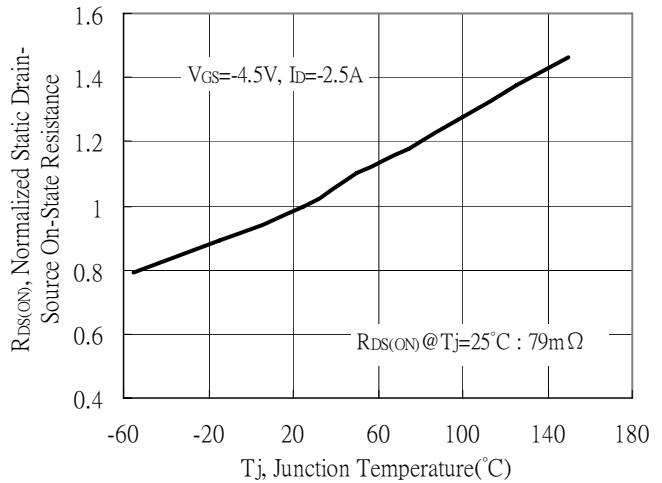

**P-channel Typical Characteristics(Cont.)**

Capacitance vs Drain-to-Source Voltage

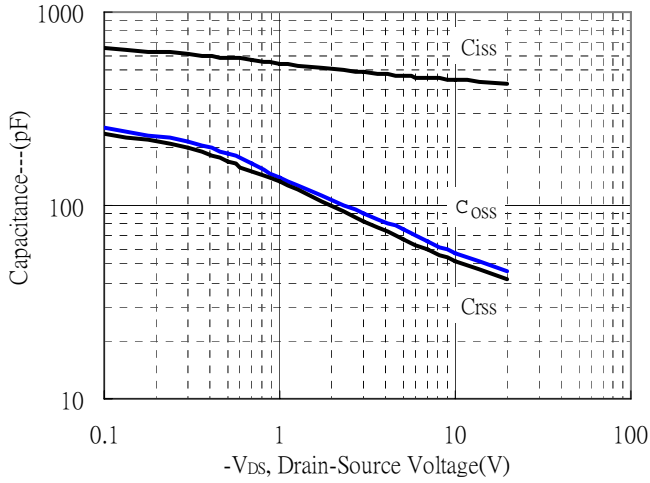

Threshold Voltage vs Junction Temperature

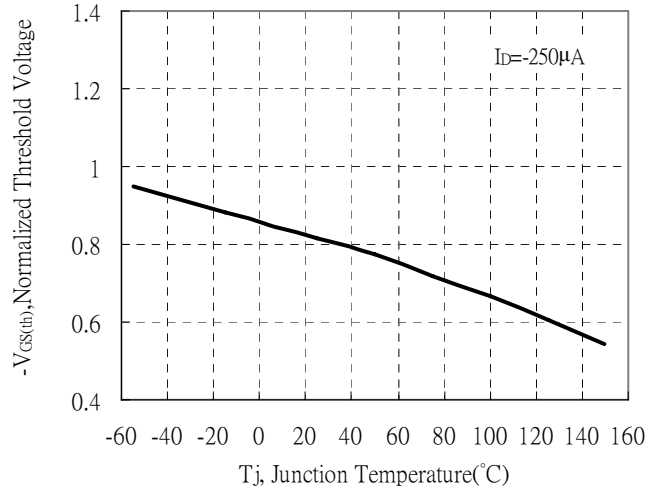

Single Pulse Power Rating, Junction to Ambient

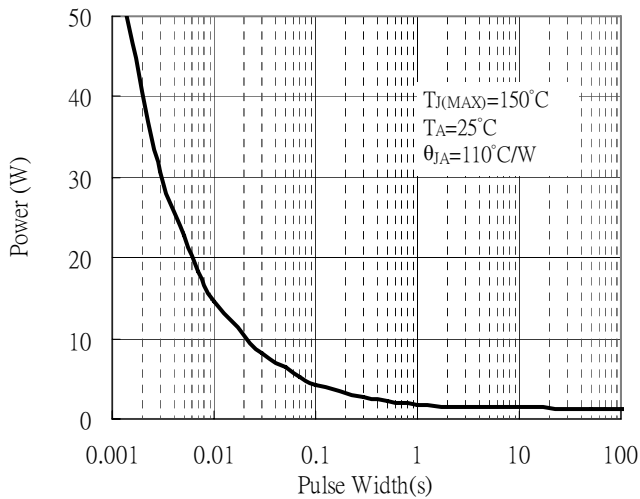

Gate Charge Characteristics

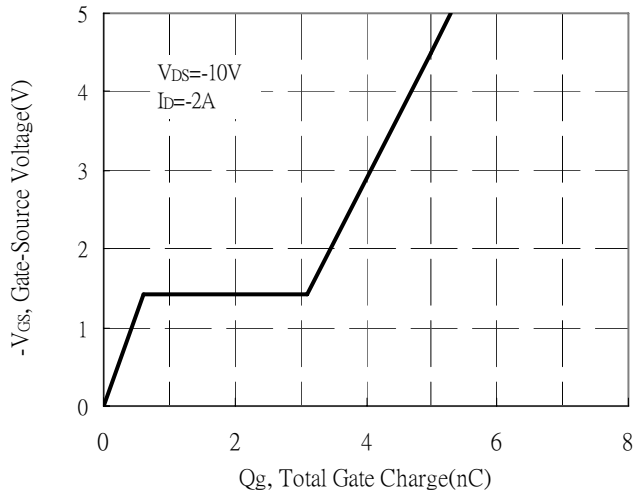

Maximum Safe Operating Area

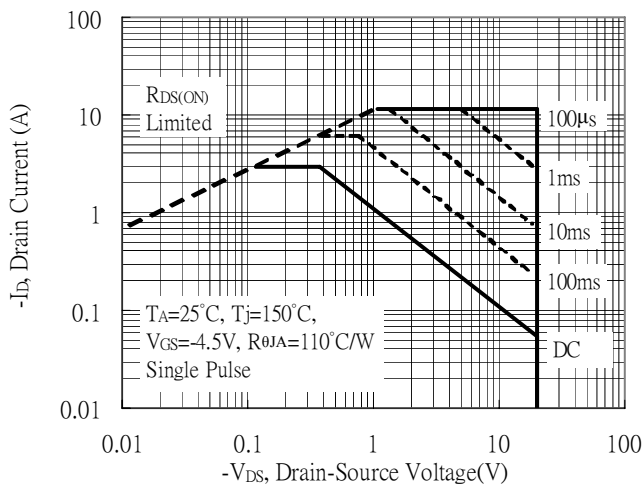

Maximum Drain Current vs Junction Temperature

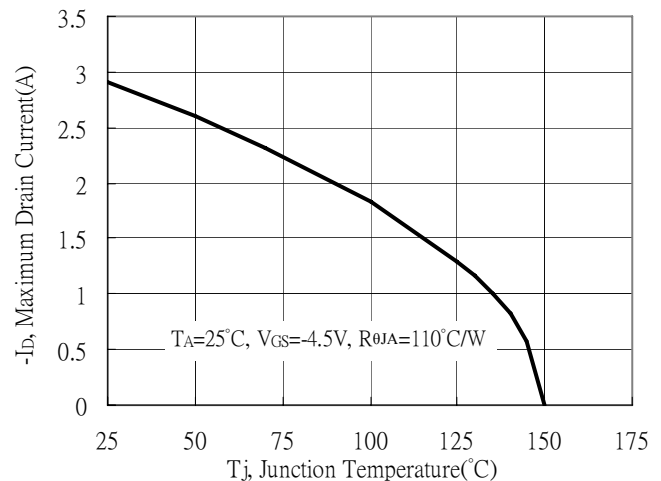



**P-channel Typical Characteristics(Cont.)**

Transient Thermal Response Curves

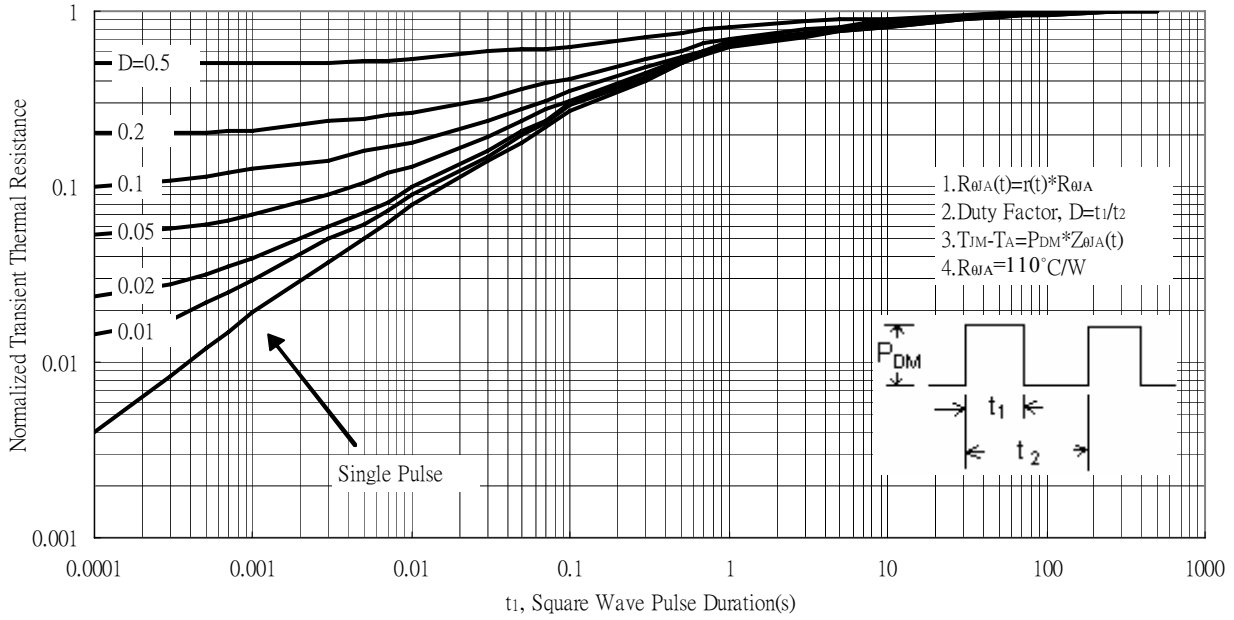

**Reel Dimension**

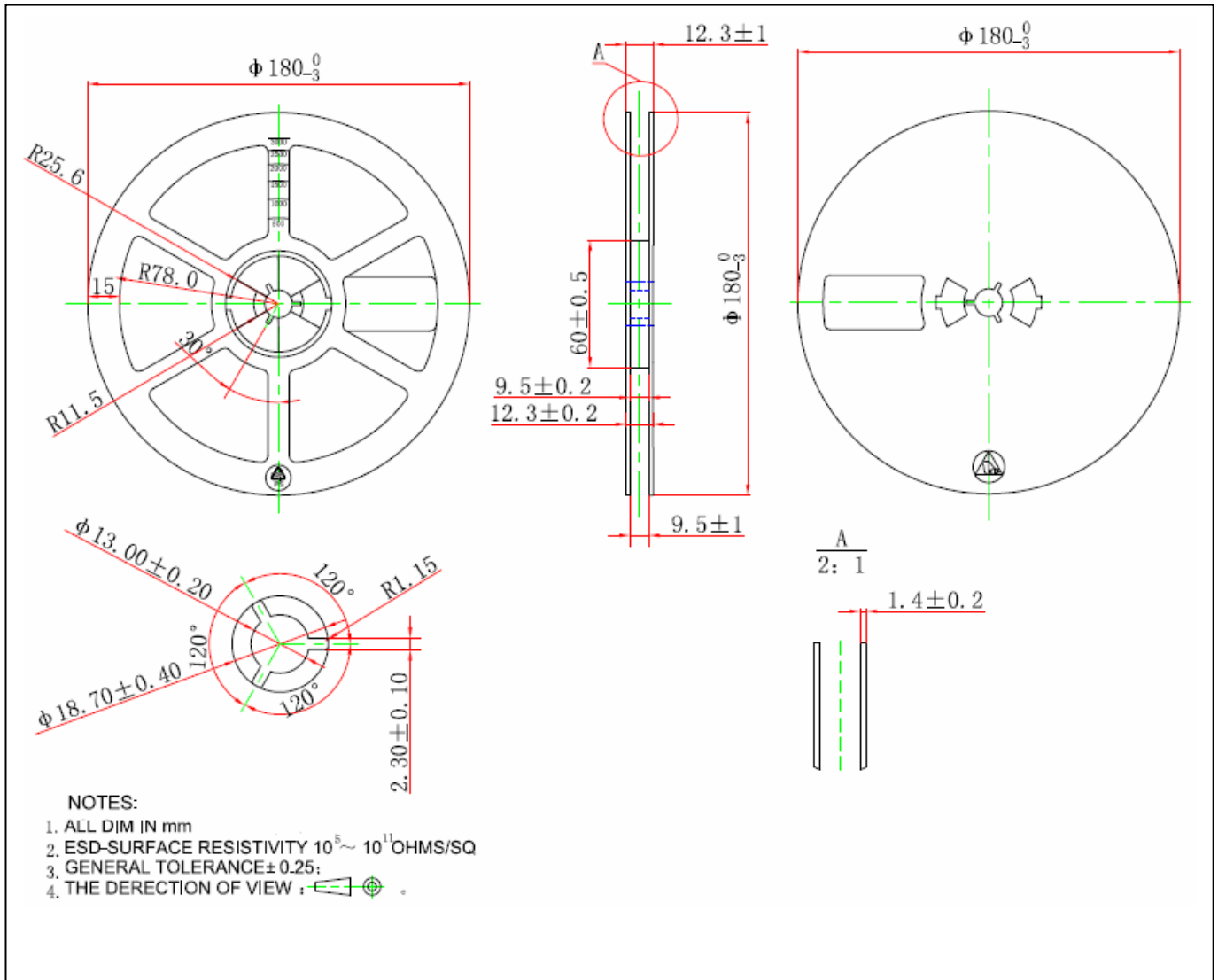

**Carrier Tape Dimension**

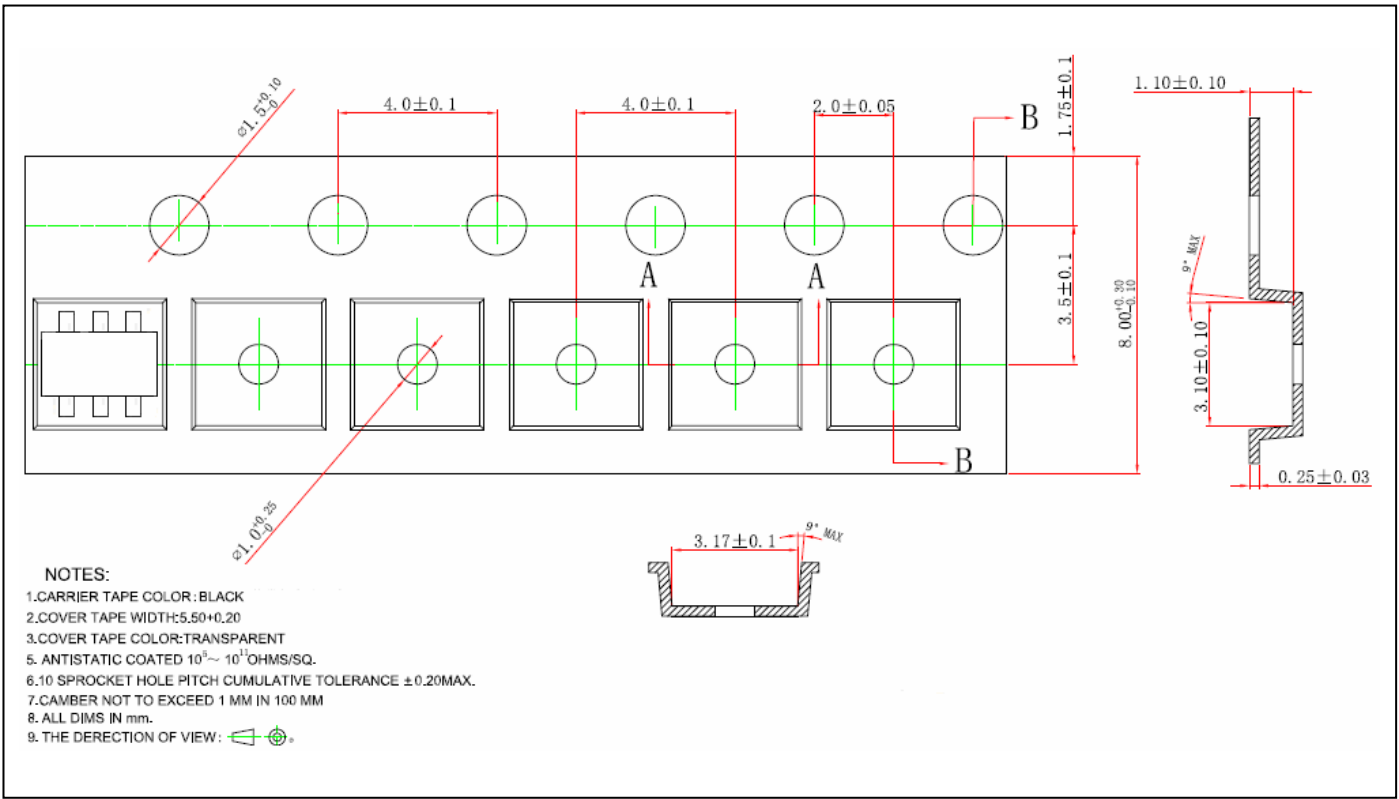

**Recommended wave soldering condition**

Product	Peak Temperature	Soldering Time
Pb-free devices	260 +0/-5 °C	5 +1/-1 seconds

**Recommended temperature profile for IR reflow**

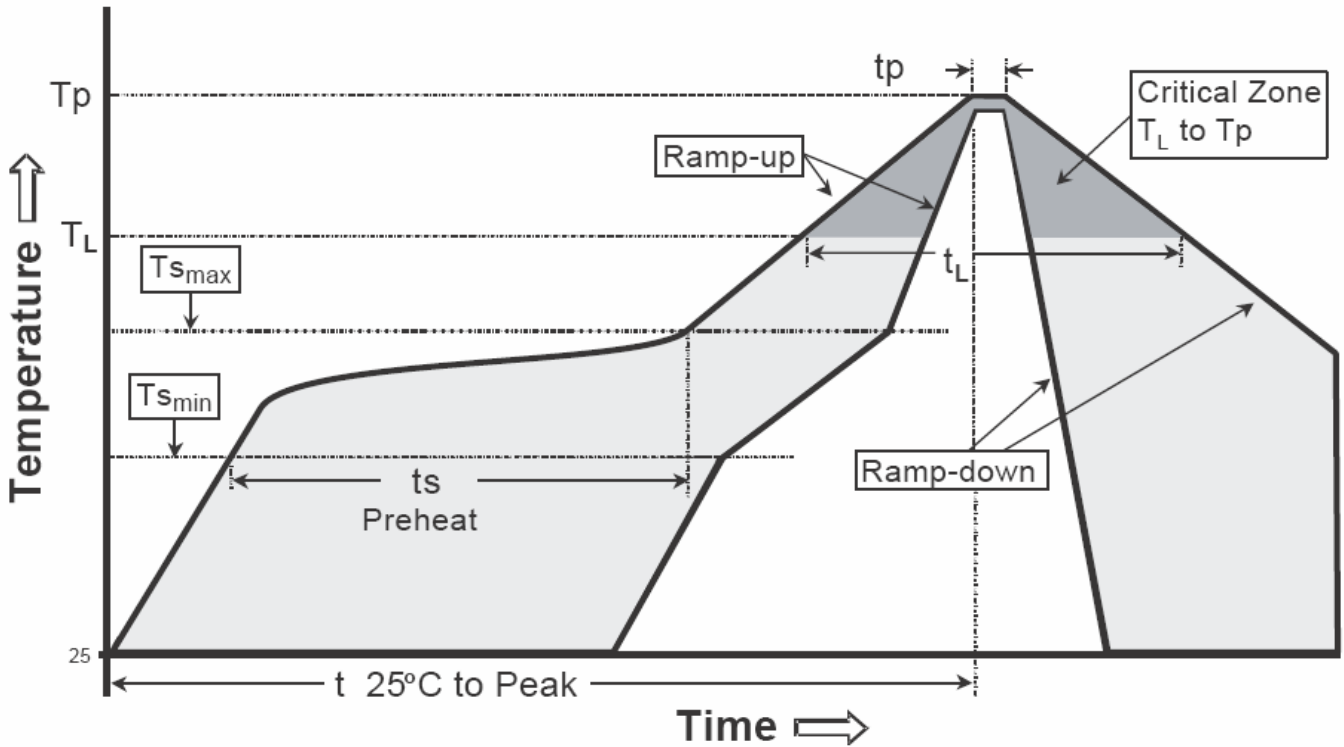

Profile feature	Sn-Pb eutectic Assembly	Pb-free Assembly
Average ramp-up rate (Tsmmax to Tp)	3°C/second max.	3°C/second max.
Preheat		
-Temperature Min(Ts min)	100°C	150°C
-Temperature Max(Ts max)	150°C	200°C
-Time(ts min to ts max)	60-120 seconds	60-180 seconds
Time maintained above:		
-Temperature (Tl)	183°C	217°C
- Time (tl)	60-150 seconds	60-150 seconds
Peak Temperature(Tp)	240 +0/-5 °C	260 +0/-5 °C
Time within 5°C of actual peak temperature(tp)	10-30 seconds	20-40 seconds
Ramp down rate	6°C/second max.	6°C/second max.
Time 25 °C to peak temperature	6 minutes max.	8 minutes max.

Note : All temperatures refer to topside of the package, measured on the package body surface.

**TSOP-6 Dimension**

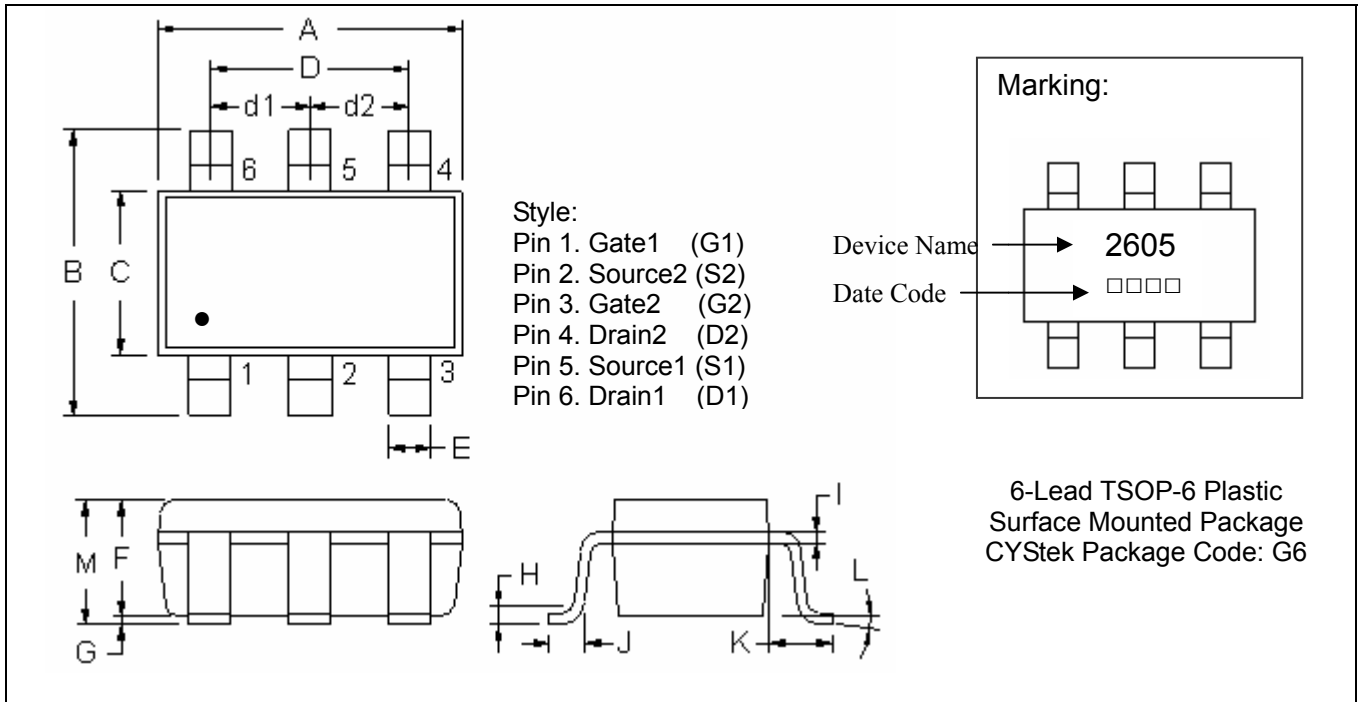

DIM	Inches		Millimeters		DIM	Inches		Millimeters	
	Min.	Max.	Min.	Max.		Min.	Max.	Min.	Max.
A	0.1063	0.1220	2.70	3.10	G	0	0.0039	0	0.10
B	0.1024	0.1181	2.60	3.00	H	-	0.0098	-	0.25
C	0.0551	0.0709	1.40	1.80	I	0.0047 REF		0.12 REF	
D	0.0748 REF		1.90 REF		J	0.0177 REF		0.45 REF	
d1	0.0374 REF		0.95 REF		K	0.0236 REF		0.60 REF	
d2	0.0374 REF		0.95 REF		L	0°	10°	0°	10°
E	0.0118	0.0197	0.30	0.50	M	-	0.0433	-	1.10
F	0.0276	0.0394	0.70	1.00					

**Notes :** 1.Controlling dimension : millimeters.  
 2.Maximum lead thickness includes lead finish thickness, and minimum lead thickness is the minimum thickness of base material.  
 3.If there is any question with packing specification or packing method, please contact your local CYStek sales office.

**Material :**

- Lead :Pure tin plated.
- Mold Compound : Epoxy resin family, flammability solid burning class:UL94V-0.

**Important Notice:**

- All rights are reserved. Reproduction in whole or in part is prohibited without the prior written approval of CYStek.
- CYStek reserves the right to make changes to its products without notice.
- CYStek **semiconductor products are not warranted to be suitable for use in Life-Support Applications, or systems.**
- CYStek assumes no liability for any consequence of customer product design, infringement of patents, or application assistance.