

**N-Channel Enhancement Mode Power MOSFET**

# MTB5D8N03RJ3

**Features**

- Low On Resistance
- Simple Drive Requirement
- Low Gate Charge
- Fast Switching Characteristic
- RoHS compliant package

|  |       |
|--|-------|
| BVDSS  | 30V   |
| $I_D @ V_{GS}=10V, T_C=25^\circ C$ (silicon limit) | 51A   |
| $I_D @ V_{GS}=10V, T_C=25^\circ C$ (package limit) | 28A   |
| $I_D @ V_{GS}=10V, T_A=25^\circ C$                 | 16A   |
| $R_{DS(on)}(typ) @ V_{GS}=10V, I_D=20A$            | 5.6mΩ |
| $R_{DS(on)}(typ) @ V_{GS}=4.5V, I_D=15A$           | 8.5mΩ |

**Symbol**

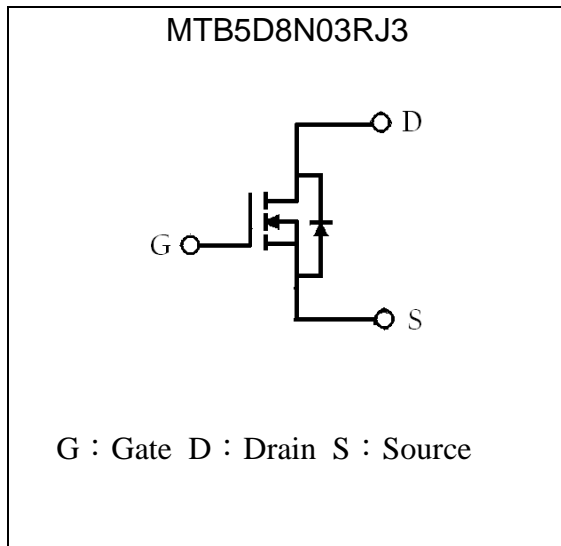

**Outline**

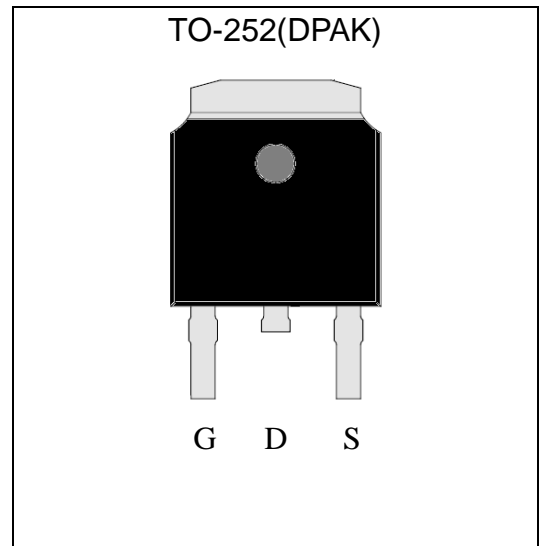

**Ordering Information**

| Device              | Package   | Shipping               |
|---------------------|---|------------------------|
| MTB5D8N03RJ3-0-T3-G | TO-252<br>(Pb-free lead plating and halogen-free package) | 2500 pcs / Tape & Reel |

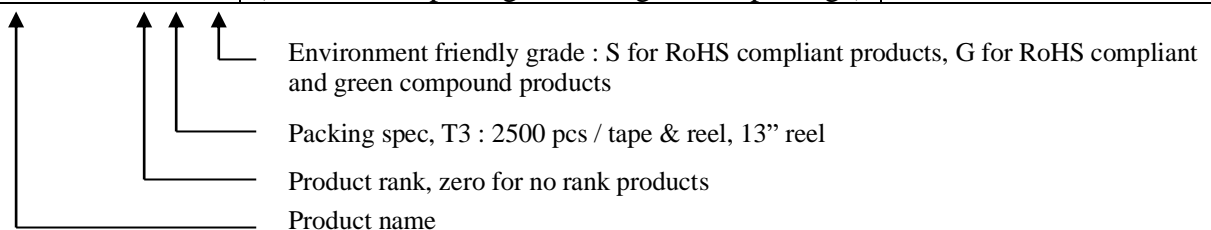

**Absolute Maximum Ratings (T<sub>C</sub>=25°C)**

| Parameter   | Symbol                            | Limits   | Unit |
|---|-----------------------------------|----------|------|
| Drain-Source Voltage (Note 1)   | V <sub>DS</sub>                   | 30       | V    |
| Gate-Source Voltage   | V <sub>GS</sub>                   | ±20      |      |
| Continuous Drain Current @ T <sub>C</sub> =25°C, V <sub>GS</sub> =10V (silicon limit) (Note 1)  | I <sub>D</sub>                    | 51       | A    |
| Continuous Drain Current @ T <sub>C</sub> =100°C, V <sub>GS</sub> =10V (silicon limit) (Note 1) |                                   | 32.2     |      |
| Continuous Drain Current @ T <sub>C</sub> =25°C, V <sub>GS</sub> =10V (package limit)           |                                   | 28       |      |
| Continuous Drain Current @ T <sub>A</sub> =25°C, V <sub>GS</sub> =10V (Note 2)                  |                                   | 16       |      |
| Continuous Drain Current @ T <sub>A</sub> =70°C, V <sub>GS</sub> =10V (Note 2)                  |                                   | 12.8     |      |
| Pulsed Drain Current (Note 3)   | I <sub>DM</sub>                   | 112      |      |
| Avalanche Current @ L=0.1mH   | I <sub>AS</sub>                   | 15       |      |
| Avalanche Energy @ L=0.5mH  | E <sub>AS</sub>                   | 16       | mJ   |
| Power Dissipation   | T <sub>C</sub> =25°C (Note 1)     | 32       | W    |
|   | T <sub>C</sub> =100°C (Note 1)    | 12.8     |      |
|   | T <sub>A</sub> =25°C (Note 2)     | 3.2      |      |
|   | T <sub>A</sub> =70°C (Note 2)     | 2        |      |
| Operating Junction and Storage Temperature  | T <sub>J</sub> , T <sub>stg</sub> | -55~+150 |      |

**Thermal Data**

| Parameter   | Symbol           | Value | Unit |
|---|------------------|-------|------|
| Thermal Resistance, Junction-to-case, max             | R <sub>θJC</sub> | 3.9   | °C/W |
| Thermal Resistance, Junction-to-ambient, max (Note 2) | R <sub>θJA</sub> | 39    |      |

- Note : 1. The power dissipation P<sub>D</sub> is based on T<sub>J(MAX)</sub>=150°C, using junction-to-case thermal resistance, and is more useful in setting the upper dissipation limit for cases where additional heatsinking is used.
2. The value of R<sub>θJA</sub> is measured with the device mounted on 1 in<sup>2</sup>FR-4 board with 2 oz. copper, in a still air environment with T<sub>A</sub>=25°C. The power dissipation P<sub>DSM</sub> is based on R<sub>θJA</sub> and the maximum allowed junction temperature of 150°C. The value in any given application depends on the user's specific board design.
3. Pulse width limited by junction temperature T<sub>J(MAX)</sub>=150°C. Ratings are based on low frequency and low duty cycles to keep initial T<sub>J</sub>=25°C.

**Characteristics (T<sub>j</sub>=25°C, unless otherwise specified)**

| Symbol                              | Min. | Typ. | Max. | Unit  | Test Conditions   |
|-------------------------------------|------|------|------|-------|---|
| <b>Static</b>                       |      |      |      |       |   |
| BV <sub>DSS</sub>                   | 30   | -    | -    | V     | V <sub>GS</sub> =0V, I <sub>D</sub> =250μA  |
| ΔBV <sub>DSS</sub> /ΔT <sub>j</sub> | -    | 0.04 | -    | mV/°C | Reference to 25°C, I <sub>D</sub> =250μA  |
| V <sub>GS(th)</sub>                 | 1    | -    | 2.5  | V     | V <sub>DS</sub> =10V, I <sub>D</sub> =250μA   |
| *G <sub>FS</sub>                    | -    | 15.4 | -    | S     | V <sub>DS</sub> =5V, I <sub>D</sub> =7A   |
| I <sub>GSS</sub>                    | -    | -    | ±100 | nA    | V <sub>GS</sub> =±20V, V <sub>DS</sub> =0V  |
| I <sub>DSS</sub>                    | -    | -    | 1    | μA    | V <sub>DS</sub> =24V, V <sub>GS</sub> =0V   |
|                                     | -    | -    | 10   |       | V <sub>DS</sub> =24V, V <sub>GS</sub> =0V, T <sub>J</sub> =85°C                       |
| *R <sub>DS(ON)</sub>                | -    | 5.6  | 7.3  | mΩ    | V <sub>GS</sub> =10V, I <sub>D</sub> =20A   |
|                                     | -    | 8.5  | 12.5 |       | V <sub>GS</sub> =4.5V, I <sub>D</sub> =15A  |
| <b>Dynamic</b>                      |      |      |      |       |   |
| *Q <sub>g</sub>                     | -    | 14   | -    | nC    | V <sub>DS</sub> =15V, I <sub>D</sub> =20A, V <sub>GS</sub> =10V                       |
| *Q <sub>gs</sub>                    | -    | 2.9  | -    |       |   |
| *Q <sub>gd</sub>                    | -    | 2.5  | -    |       |   |
| *t <sub>d(ON)</sub>                 | -    | 3.5  | -    | ns    | V <sub>DS</sub> =15V, I <sub>D</sub> =20A, V <sub>GS</sub> =10V, R <sub>G</sub> =1.6Ω |
| *t <sub>r</sub>                     | -    | 5    | -    |       |   |
| *t <sub>d(OFF)</sub>                | -    | 11   | -    |       |   |
| *t <sub>f</sub>                     | -    | 3    | -    |       |   |
| C <sub>iss</sub>                    | -    | 755  | -    | pF    | V <sub>GS</sub> =0V, V <sub>DS</sub> =15V, f=1MHz                                     |
| C <sub>oss</sub>                    | -    | 507  | -    |       |   |
| C <sub>rss</sub>                    | -    | 59   | -    |       |   |
| R <sub>g</sub>                      | -    | 0.8  | -    | Ω     | f=1MHz  |
| <b>Source-Drain Diode</b>           |      |      |      |       |   |
| *I <sub>S</sub>                     | -    | -    | 28   | A     |   |
| *I <sub>SM</sub>                    | -    | -    | 112  |       |   |
| *V <sub>SD</sub>                    | -    | 0.89 | 1.2  | V     | I <sub>S</sub> =20A, V <sub>GS</sub> =0V  |
| *t <sub>rr</sub>                    | -    | 14.3 | -    | ns    | V <sub>GS</sub> =0V, I <sub>F</sub> =20A, dI <sub>F</sub> /dt=100A/μs                 |
| *Q <sub>rr</sub>                    | -    | 5.1  | -    | nC    |   |

\*Pulse Test : Pulse Width ≤300μs, Duty Cycle≤2%

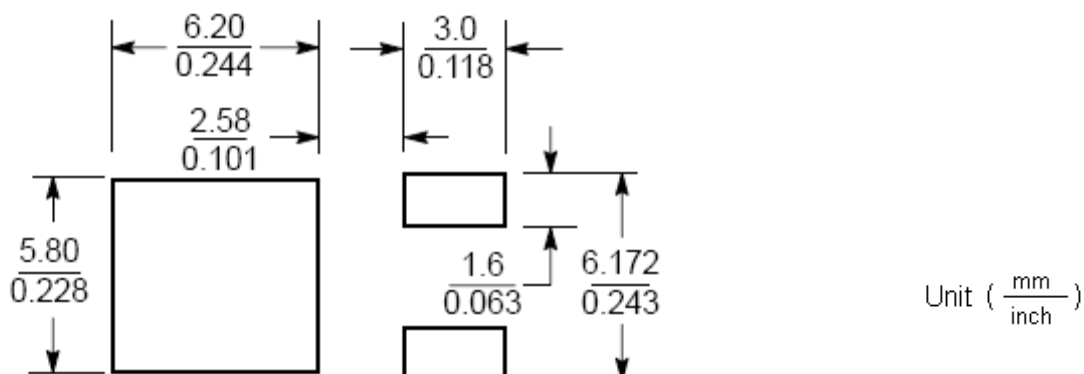
**Recommended soldering footprint**

## Typical Characteristics

Typical Output Characteristics

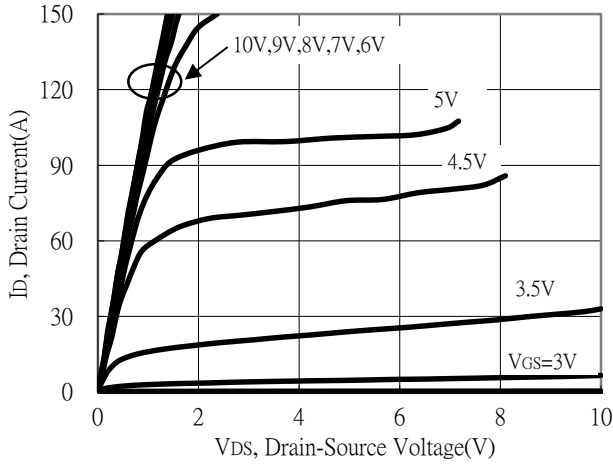

Breakdown Voltage vs Ambient Temperature

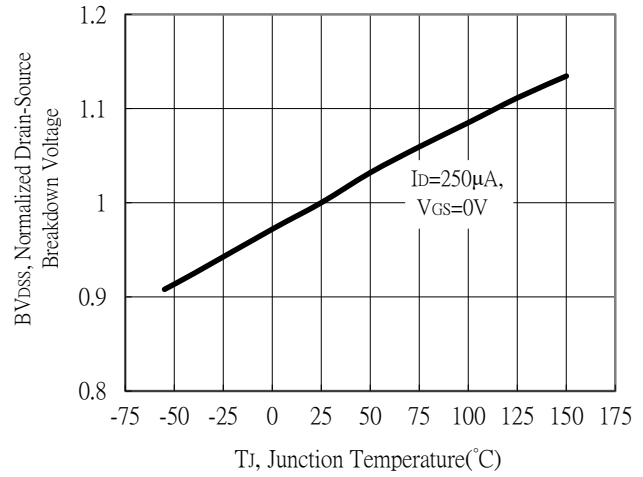

Static Drain-Source On-State resistance vs Drain Current

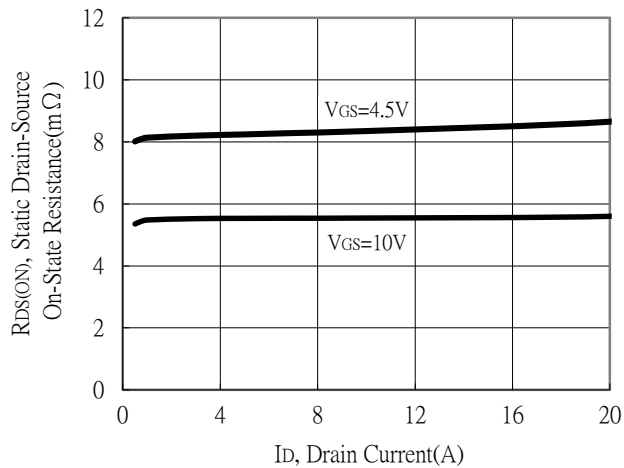

Reverse Drain Current vs Source-Drain Voltage

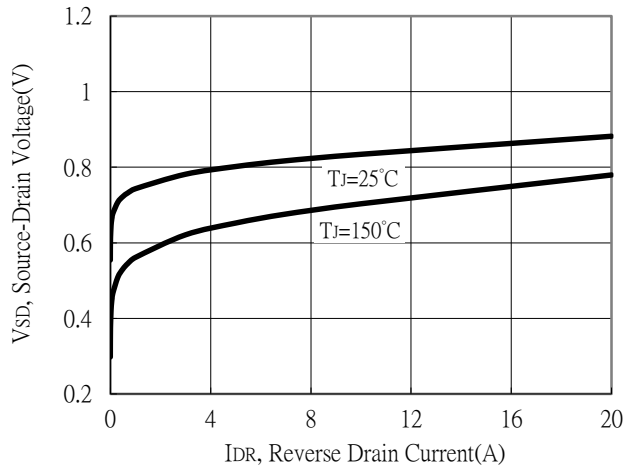

Static Drain-Source On-State Resistance vs Gate-Source Voltage

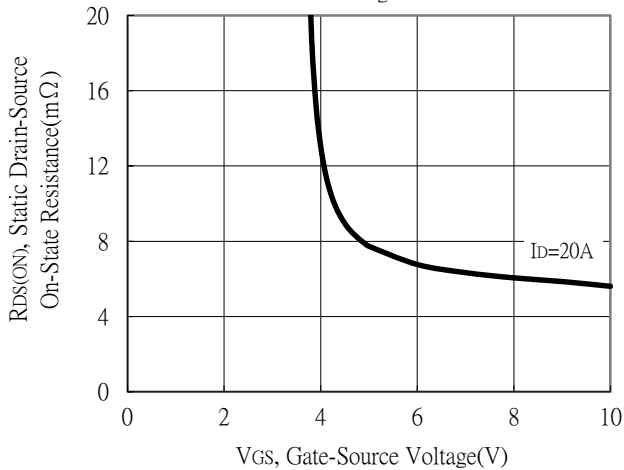

Drain-Source On-State Resistance vs Junction Temperature

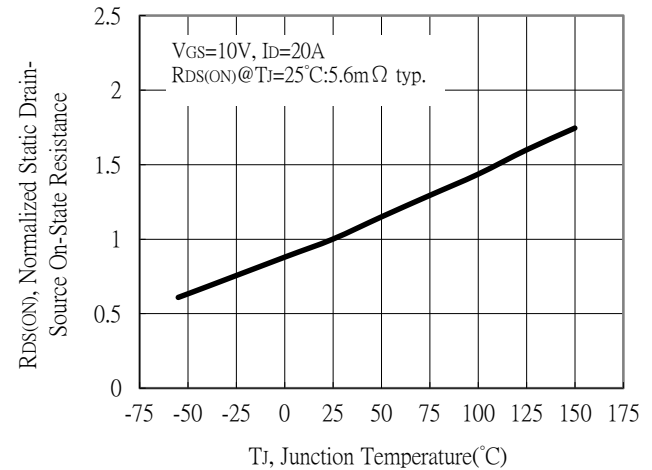

## Typical Characteristics(Cont.)

Capacitance vs Drain-to-Source Voltage

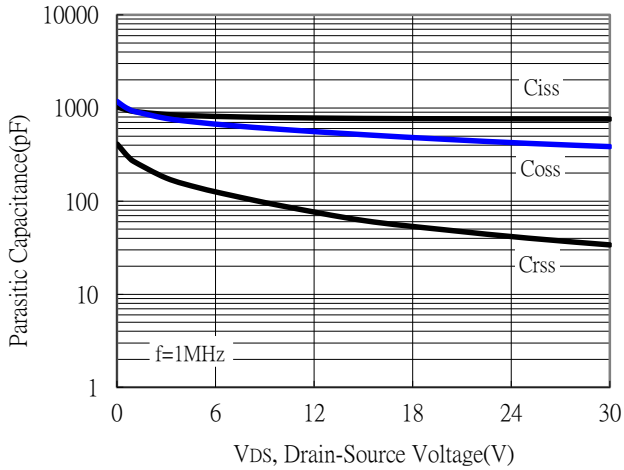

Threshold Voltage vs Junction Temperature

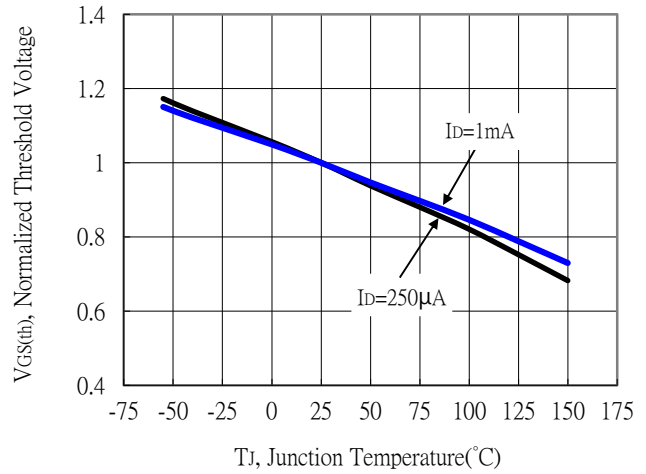

Forward Transfer Admittance vs Drain Current

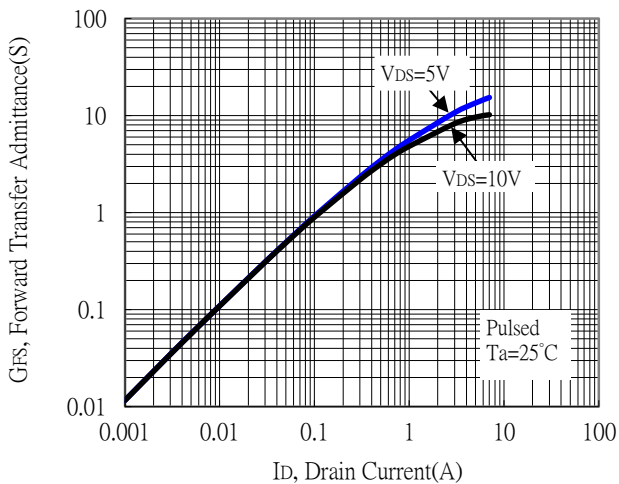

Gate Charge Characteristics

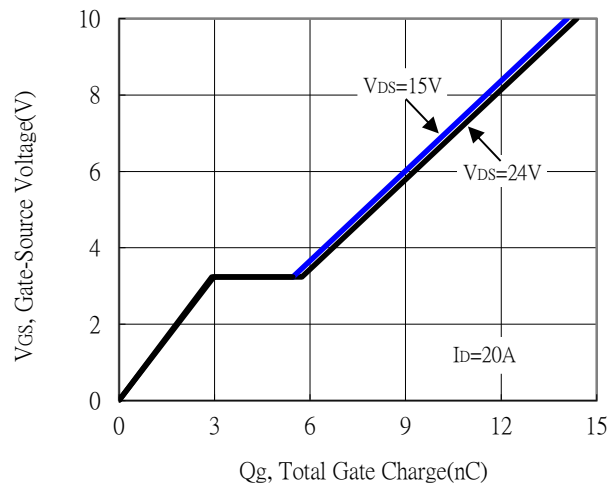

Maximum Safe Operating Area

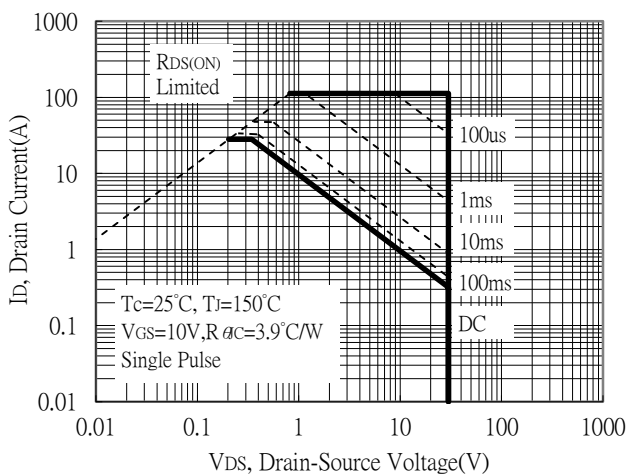

Maximum Drain Current vs Case Temperature

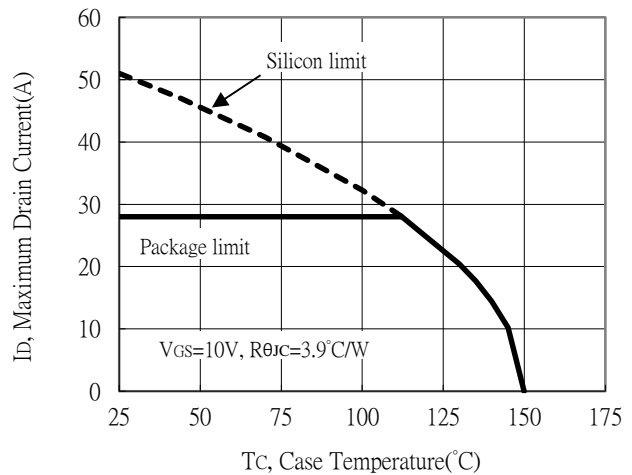

**Typical Characteristics(Cont.)**

Power Derating Curve

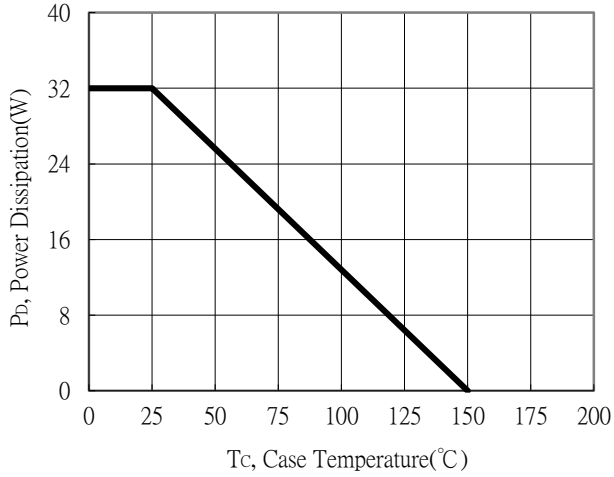

Single Pulse Maximum Power Dissipation

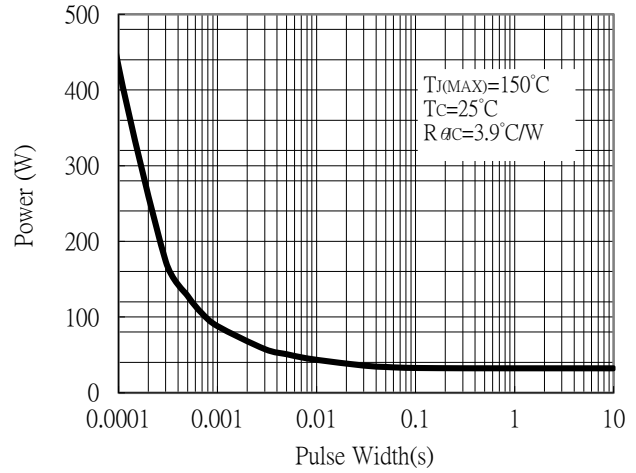

Transient Thermal Response Curves

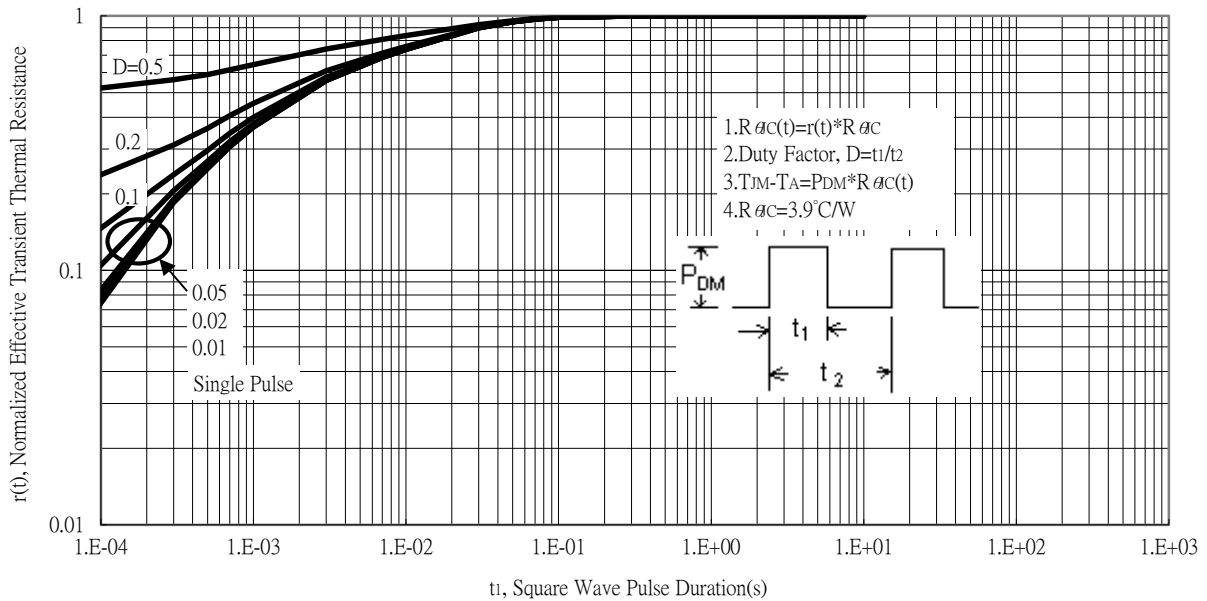



**Recommended wave soldering condition**

|                 |                  |                 |
|-----------------|------------------|-----------------|
| Product         | Peak Temperature | Soldering Time  |
| Pb-free devices | 260 +0/-5 °C     | 5 +1/-1 seconds |

**Recommended temperature profile for IR reflow**

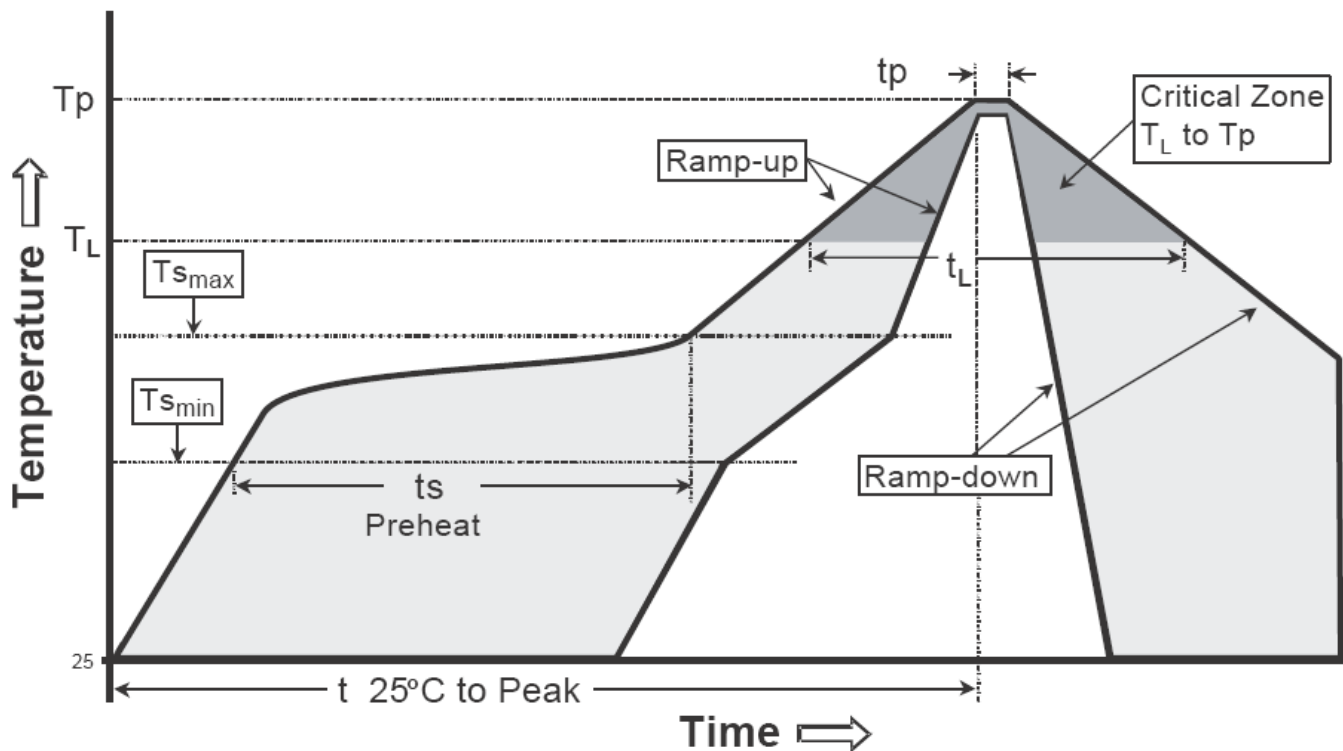

| Profile feature                                | Sn-Pb eutectic Assembly | Pb-free Assembly |
|--|-------------------------|------------------|
| Average ramp-up rate (Tsmmax to Tp)            | 3°C/second max.         | 3°C/second max.  |
| Preheat  |                         |                  |
| -Temperature Min(Ts min)                       | 100°C                   | 150°C            |
| -Temperature Max(Ts max)                       | 150°C                   | 200°C            |
| -Time(ts min to ts max)                        | 60-120 seconds          | 60-180 seconds   |
| Time maintained above:                         |                         |                  |
| -Temperature (Tl)                              | 183°C                   | 217°C            |
| - Time (tL)                                    | 60-150 seconds          | 60-150 seconds   |
| Peak Temperature(Tp)                           | 240 +0/-5 °C            | 260 +0/-5 °C     |
| Time within 5°C of actual peak temperature(tp) | 10-30 seconds           | 20-40 seconds    |
| Ramp down rate                                 | 6°C/second max.         | 6°C/second max.  |
| Time 25 °C to peak temperature                 | 6 minutes max.          | 8 minutes max.   |

Note : All temperatures refer to topside of the package, measured on the package body surface.



**TO-252 Dimension**

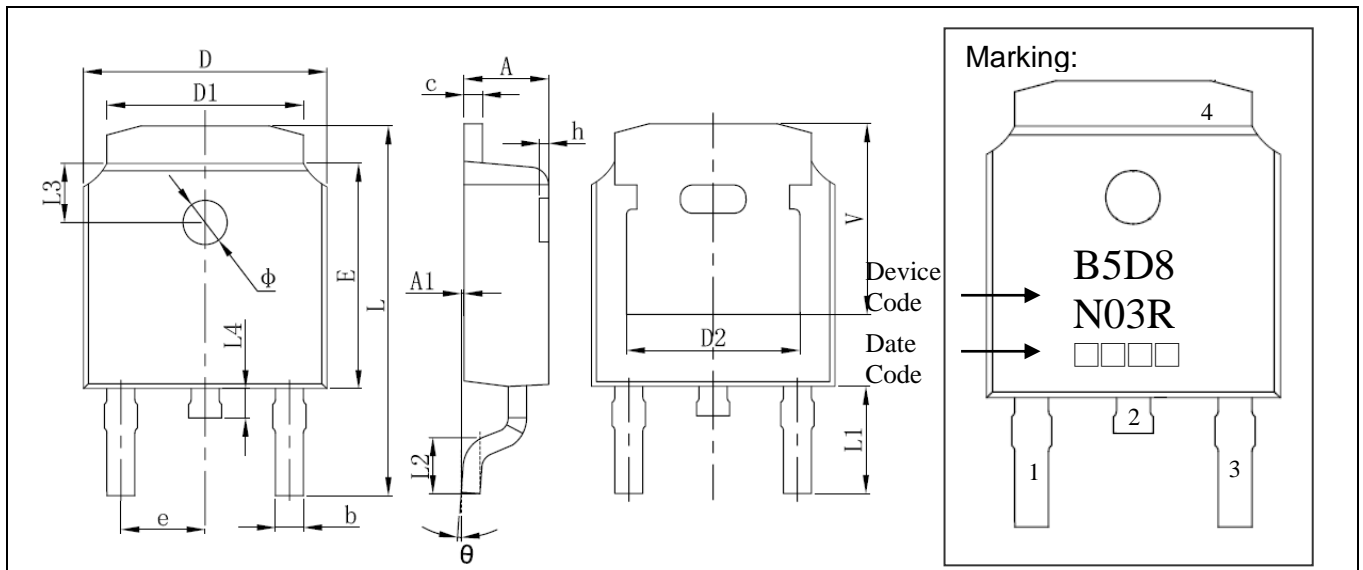

**3-Lead TO-252 Plastic Surface Mount Package**  
 CYStek Package Code: J3

Style: Pin 1.Gate 2.Drain 3.Source 4.Drain

Date Code :

First Code : Last digit of Christian Year  
 Second Code : Month Code : Jan→A, Feb→B, Mar→C, Apr→D, May→E, Jun→F, Jul→G,  
 Aug→H, Sep→J, Oct→K, Nov→L, Dec→M  
 Last Two Codes : Production Serial Code, 01~99

| DIM | Inches |       | Millimeters |       | DIM | Inches |       | Millimeters |        |
|-----|--------|-------|-------------|-------|-----|--------|-------|-------------|--------|
|     | Min.   | Max.  | Min.        | Max.  |     | Min.   | Max.  | Min.        | Max.   |
| A   | 0.087  | 0.094 | 2.200       | 2.400 | L   | 0.382  | 0.406 | 9.712       | 10.312 |
| A1  | 0.000  | 0.005 | 0.000       | 0.127 | L1  | 0.114  | REF   | 2.900       | REF    |
| b   | 0.025  | 0.030 | 0.635       | 0.770 | L2  | 0.055  | 0.067 | 1.400       | 1.700  |
| c   | 0.018  | 0.023 | 0.460       | 0.580 | L3  | 0.063  | REF   | 1.600       | REF    |
| D   | 0.256  | 0.264 | 6.500       | 6.700 | L4  | 0.024  | 0.039 | 0.600       | 1.000  |
| D1  | 0.201  | 0.215 | 5.100       | 5.460 | Φ   | 0.043  | 0.051 | 1.100       | 1.300  |
| D2  | 0.190  | REF   | 4.830       | REF   | θ   | 0°     | 8°    | 0°          | 8°     |
| E   | 0.236  | 0.244 | 6.000       | 6.200 | h   | 0.000  | 0.012 | 0.000       | 0.300  |
| e   | 0.086  | 0.094 | 2.186       | 2.386 | v   | 0.207  | REF   | 5.250       | REF    |

Notes: 1.Controlling dimension: millimeters.  
 2.Maximum lead thickness includes lead finish thickness, and minimum lead thickness is the minimum thickness of base material.  
 3.If there is any question with packing specification or packing method, please contact your local CYStek sales office.

**Material:**

- Lead : Pure tin plated.
- Mold Compound: Epoxy resin family, flammability solid burning class: UL94V-0.

**Important Notice:**

- All rights are reserved. Reproduction in whole or in part is prohibited without the prior written approval of CYStek.
- CYStek reserves the right to make changes to its products without notice.
- CYStek **semiconductor products are not warranted to be suitable for use in Life-Support Applications, or systems.**
- CYStek assumes no liability for any consequence of customer product design, infringement of patents, or application assistance.