

N-Channel Logic Level Enhancement Mode Power MOSFET

MTB2D5N03BH8

BV_{DSS}	30V
I_D@V_{GS}=10V, T_C=25°C	60A
I_D@V_{GS}=10V, T_A=25°C	20A
R_{DS(ON)}@V_{GS}=10V, I_D=30A	2.1 mΩ (typ)
R_{DS(ON)}@V_{GS}=4.5V, I_D=24A	2.9 mΩ (typ)

Features

- Single Drive Requirement
- Low On-resistance
- Fast Switching Characteristic
- Dynamic dv/dt rating
- Repetitive Avalanche Rated
- Pb-free lead plating and Halogen-free package

Symbol

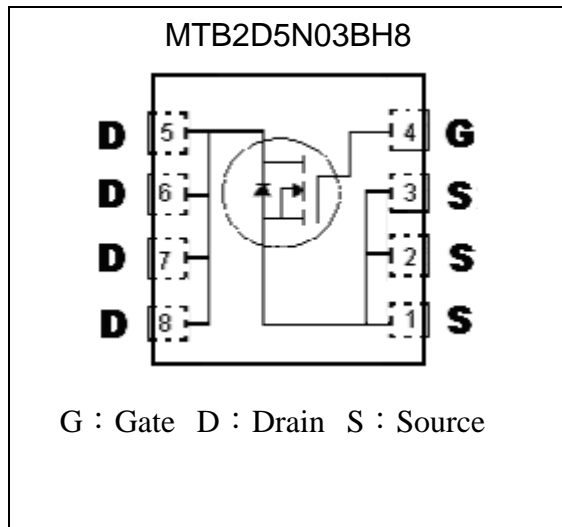

Outline

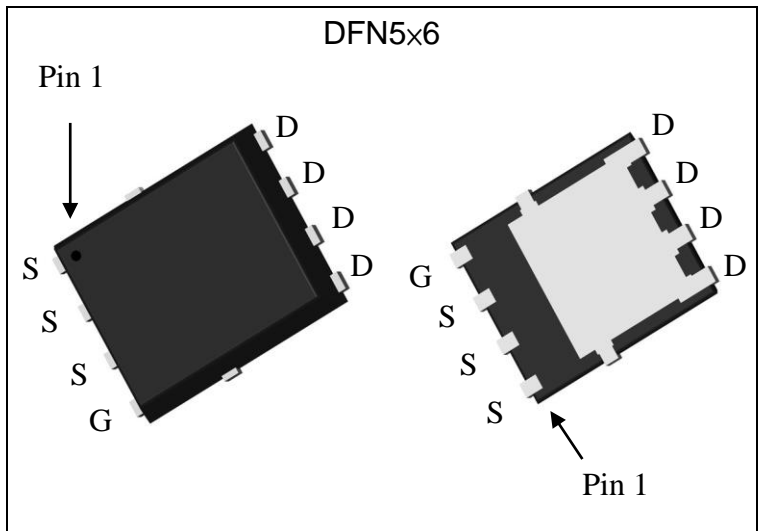

Ordering Information

Device	Package	Shipping
MTB2D5N03BH8-0-T6-G	DFN 5 x6 (Pb-free lead plating and halogen-free package)	3000 pcs / tape & reel

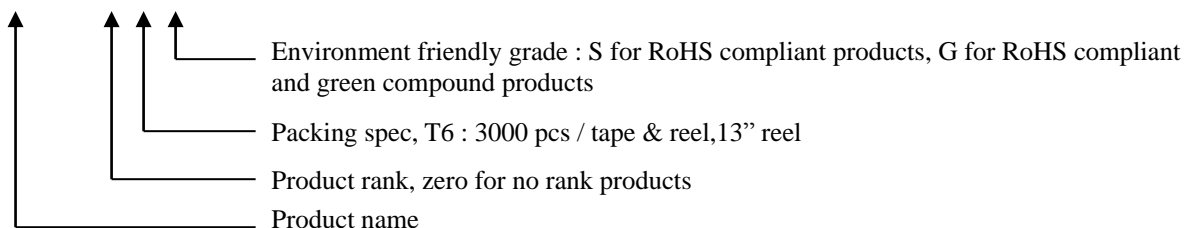



Absolute Maximum Ratings (Ta=25°C)

Parameter	Symbol	Limits	Unit	
Drain-Source Voltage	V _{DS}	30	V	
Gate-Source Voltage	V _{GS}	±20		
Continuous Drain Current @ T _C =25°C, V _{GS} =10V(Silicon limit)	I _D	90	A	
Continuous Drain Current @ T _C =100°C, V _{GS} =10V(Silicon limit)		57		
Continuous Drain Current @ T _C =25°C, V _{GS} =10V(Package limit)		60		
Continuous Drain Current @ T _A =25°C, V _{GS} =10V	I _{DSM}	20 *3		
Continuous Drain Current @ T _A =70°C, V _{GS} =10V		16 *3		
Pulsed Drain Current	I _{DM}	200 *1		
Avalanche Current	I _{AS}	30		
Avalanche Energy @ L=0.1mH, I _D =30A, R _G =25Ω	E _{AS}	45	mJ	
Total Power Dissipation	P _D	T _C =25°C	50	W
		T _C =100°C	20	
	P _D SM	T _A =25°C	2.5 *3	
		T _A =70°C	1.6 *3	
Operating Junction and Storage Temperature Range	T _j , T _{stg}	-55~+150	°C	

Thermal Data

Parameter	Symbol	Value	Unit
Thermal Resistance, Junction-to-case, max	R _{th,j-c}	2.5	°C/W
Thermal Resistance, Junction-to-ambient, max	R _{th,j-a}	50 *3	

- Note : 1. Pulse width limited by maximum junction temperature
 2. Duty cycle ≤ 1%
 3. Surface mounted on 1 in² copper pad of FR-4 board, t ≤ 10s; 125°C/W when mounted on minimum copper pad.

Characteristics (Tc=25°C, unless otherwise specified)

Symbol	Min.	Typ.	Max.	Unit	Test Conditions
Static					
BV _{DSS}	30	-	-	V	V _{GS} =0V, I _D =250μA
V _{GS(th)}	1.0	-	2.5		V _{DS} = V _{GS} , I _D =250μA
G _{FS} *1	-	50	-	S	V _{DS} =5V, I _D =20A
I _{GSS}	-	-	±100	nA	V _{GS} =±20V, V _{DS} =0V
I _{DSS}	-	-	1	μA	V _{DS} =24V, V _{GS} =0V
	-	-	25		V _{DS} =20V, V _{GS} =0V, T _j =125°C
R _{DS(ON)} *1	-	2.1	2.9	mΩ	V _{GS} =10V, I _D =30A
	-	2.9	4.0		V _{GS} =4.5V, I _D =24A
Dynamic					
C _{iss}	-	2743	-	pF	V _{GS} =0V, V _{DS} =15V, f=1MHz
C _{oss}	-	495	-		
C _{rss}	-	293	-		







Characteristics (Tc=25°C, unless otherwise specified)

Symbol	Min.	Typ.	Max.	Unit	Test Conditions
Qg (VGS=10V) *1, 2	-	55.5	-	nC	VDS=15V, VGS=10V, ID=30A
Qg (VGS=4.5V) *1, 2	-	27.6	-		
Qgs *1, 2	-	9.7	-		
Qgd *1, 2	-	11.5	-		
td(ON) *1, 2	-	17.6	-	ns	VDS=15V, ID=24A, VGS=10V, RGS=2.7Ω
tr *1, 2	-	20.2	-		
td(OFF) *1, 2	-	59	-		
tf *1, 2	-	13.6	-		
Rg	-	1.2	-	Ω	f=1MHz
Source-Drain Diode					
IS *1	-	-	60	A	
ISM *3	-	-	200		
VSD *1	-	0.8	1.2	V	IS=20A, VGS=0V
trr	-	19	-	ns	IF=24A, dIF/dt=100A/μs
Qrr	-	10.5	-	nC	

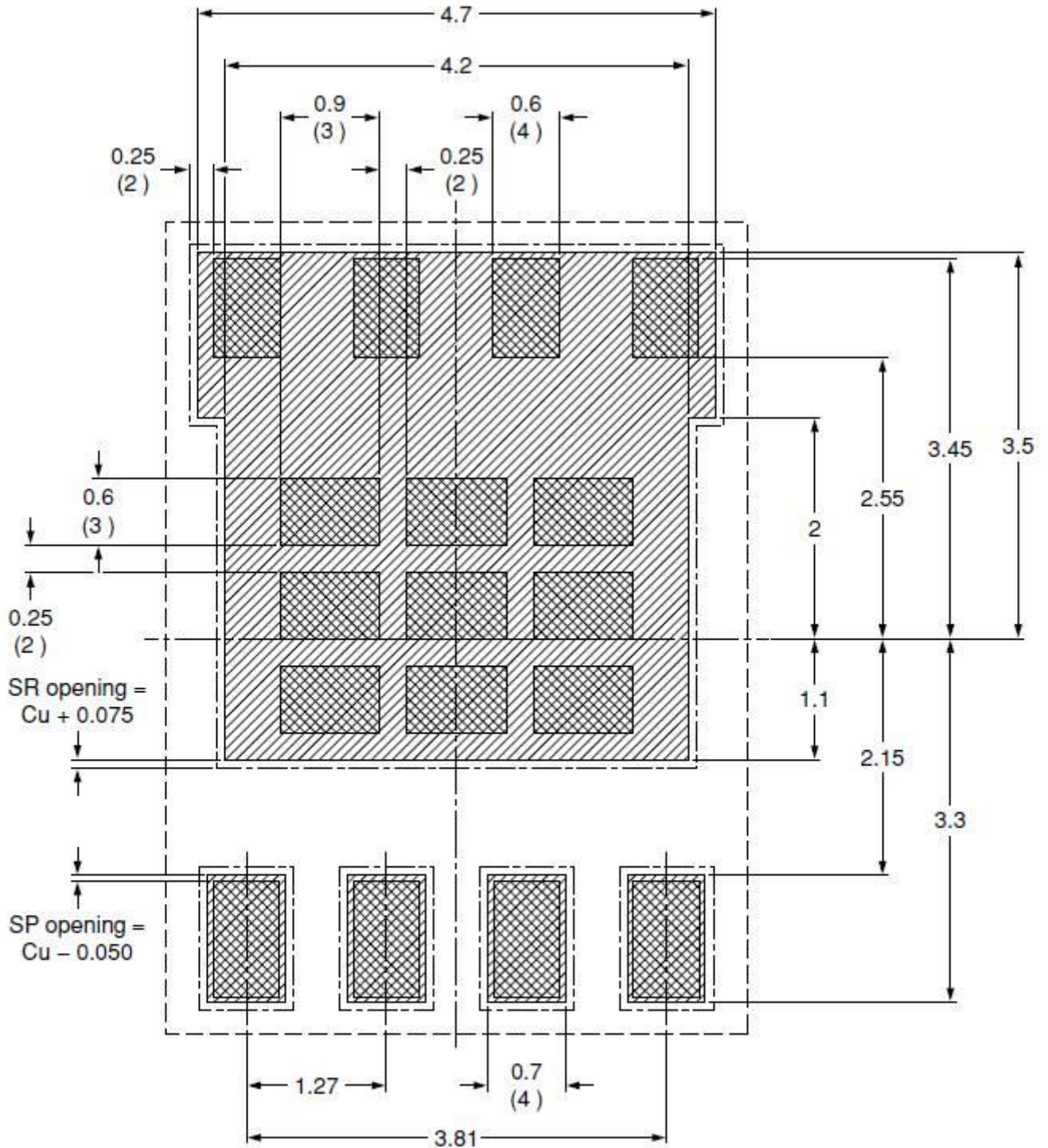
Note : *1.Pulse Test : Pulse Width ≤300μs, Duty Cycle≤2%
*2.Independent of operating temperature
*3.Pulse width limited by maximum junction temperature.

Recommended Soldering Footprint & Stencil Design

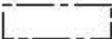

- | | |
|---|--|
|  solder lands |  solder paste
125 μm stencil |
|  solder resist |  occupied area |

unit : mm

Typical Characteristics

Typical Output Characteristics

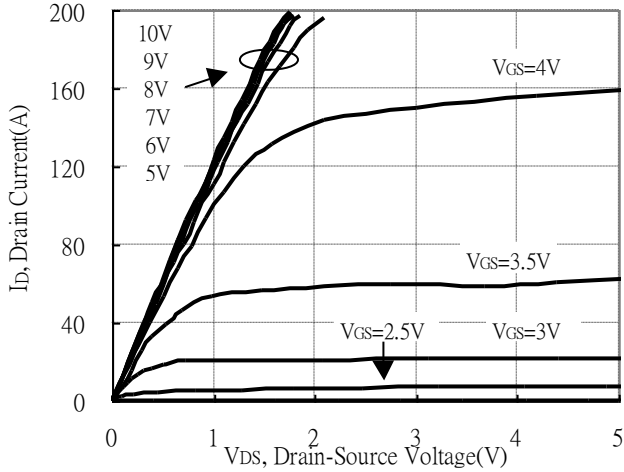

Brekdown Voltage vs Ambient Temperature

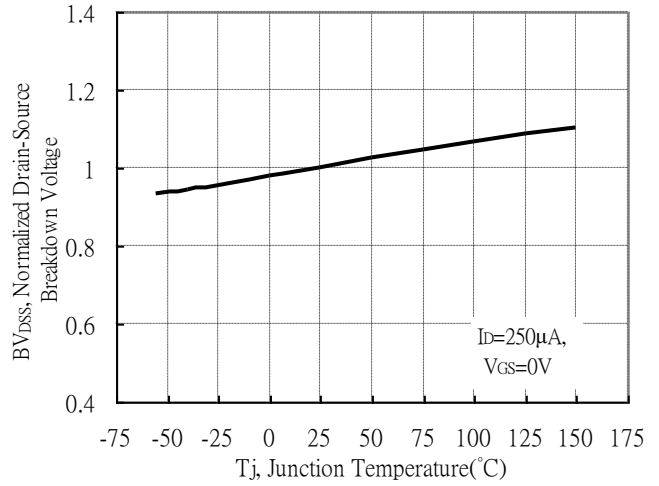

Static Drain-Source On-State resistance vs Drain Current

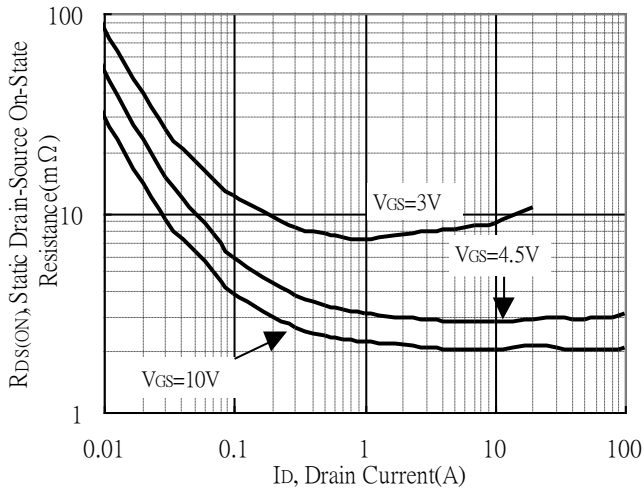

Reverse Drain Current vs Source-Drain Voltage

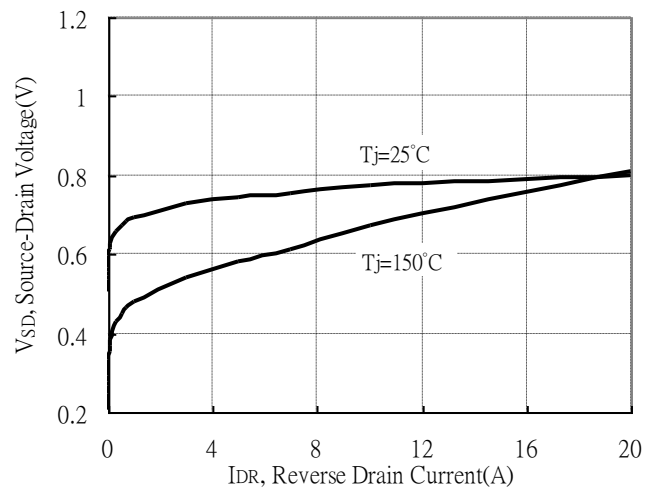

Static Drain-Source On-State Resistance vs Gate-Source Voltage

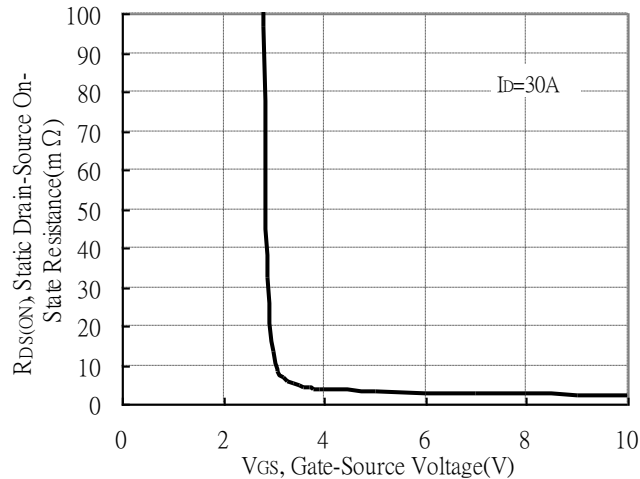

Drain-Source On-State Resistance vs Junction Temperature

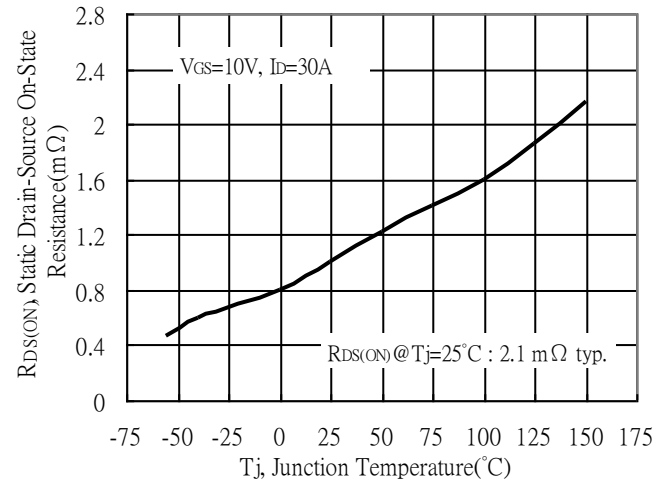

Typical Characteristics(Cont.)

Capacitance vs Drain-to-Source Voltage

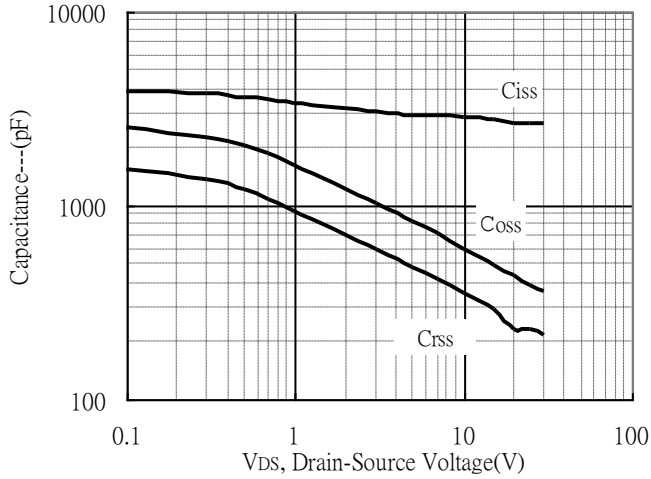

Threshold Voltage vs Junction Temperature

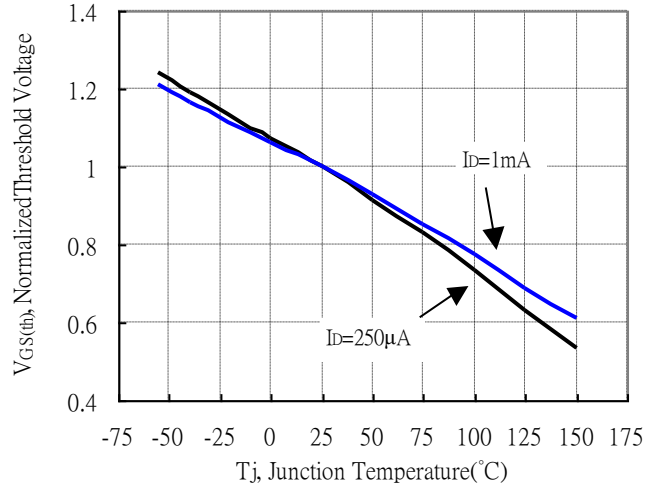

Forward Transfer Admittance vs Drain Current

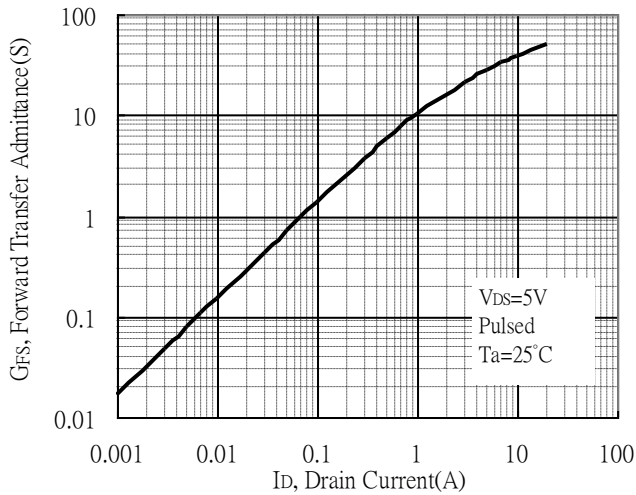

Gate Charge Characteristics

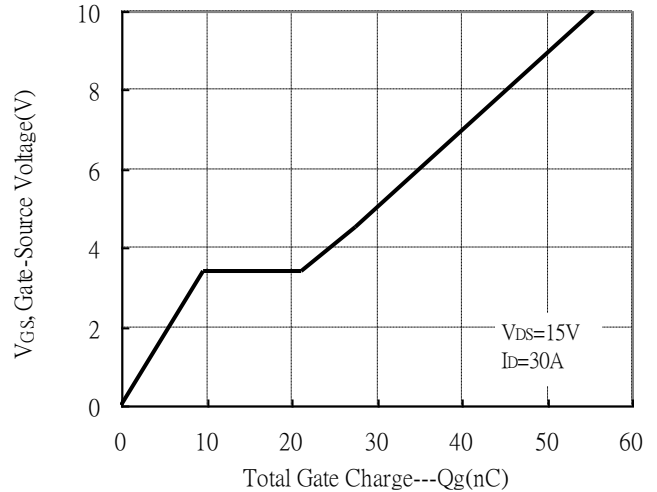

Maximum Safe Operating Area

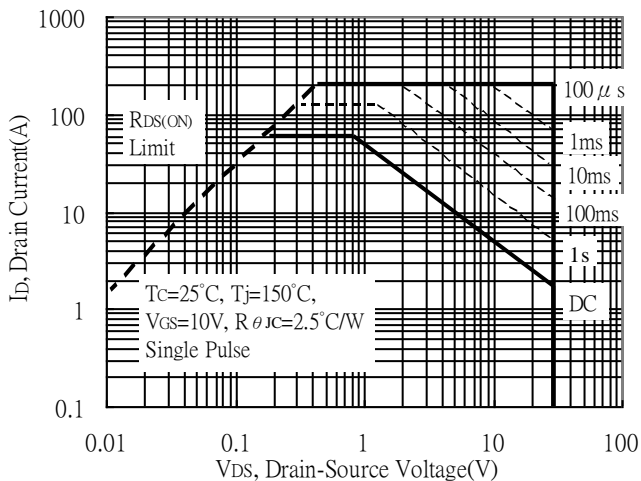

Maximum Drain Current vs Case Temperature

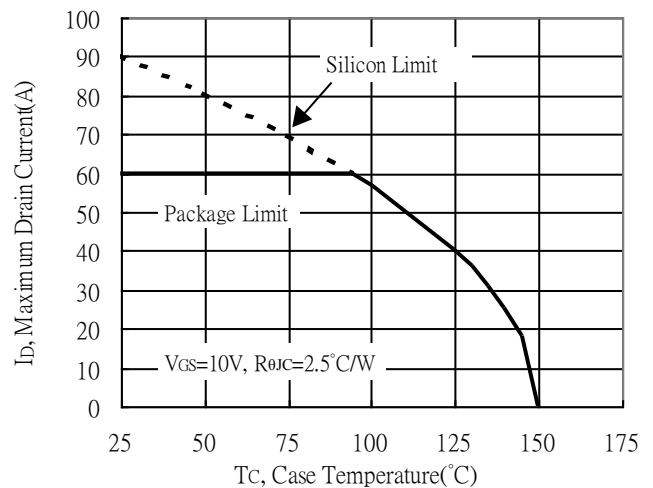

Typical Characteristics(Cont.)

Typical Transfer Characteristics

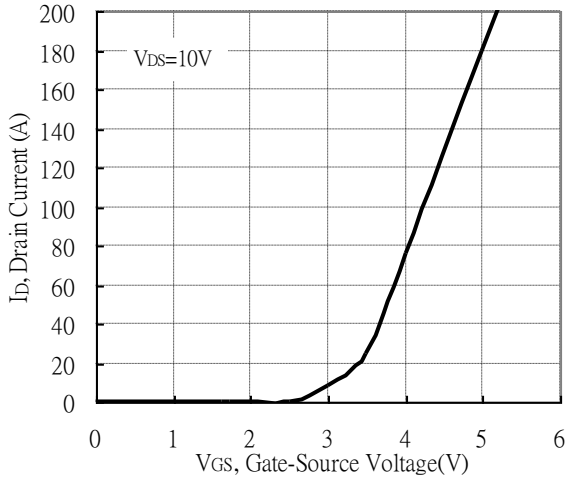

Single Pulse Maximum Power Dissipation

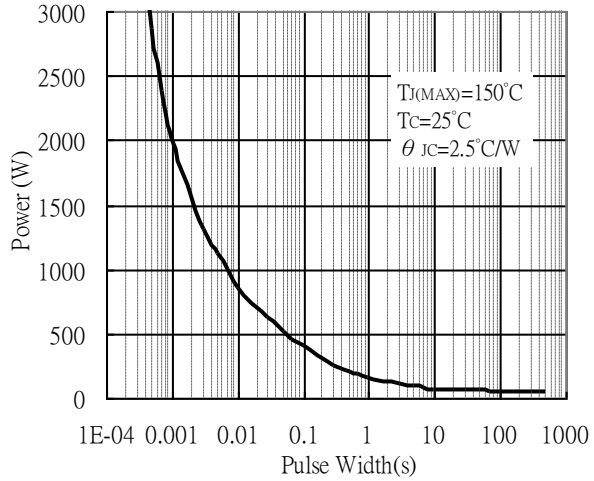

Transient Thermal Response Curves

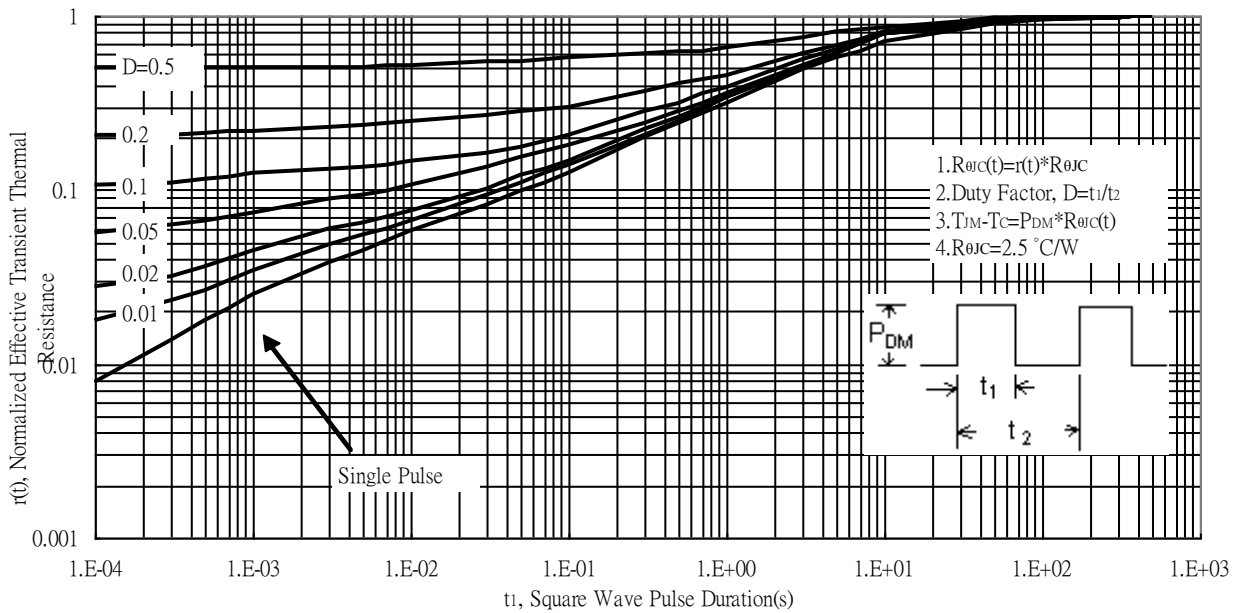

Reel Dimension

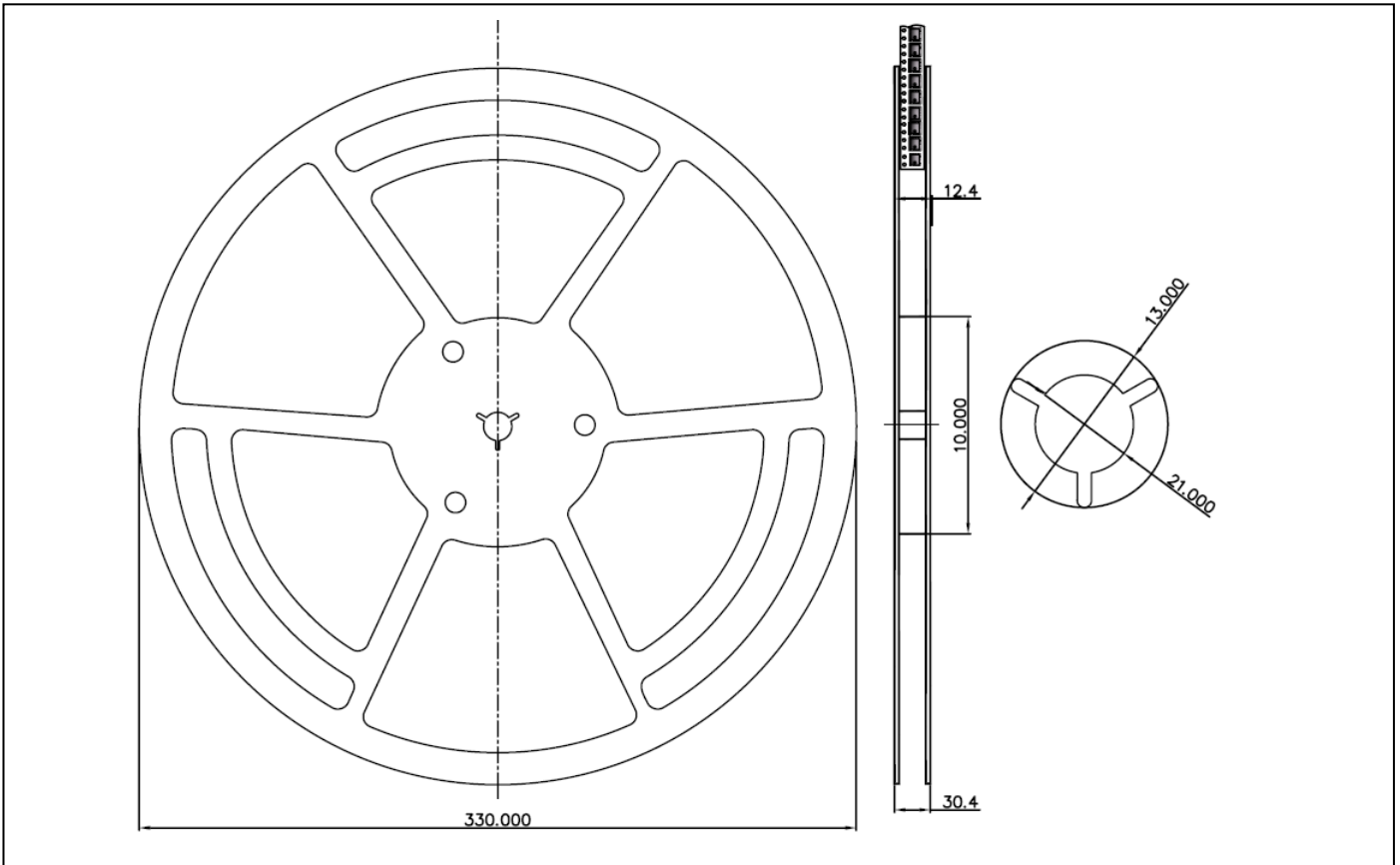

Carrier Tape Dimension

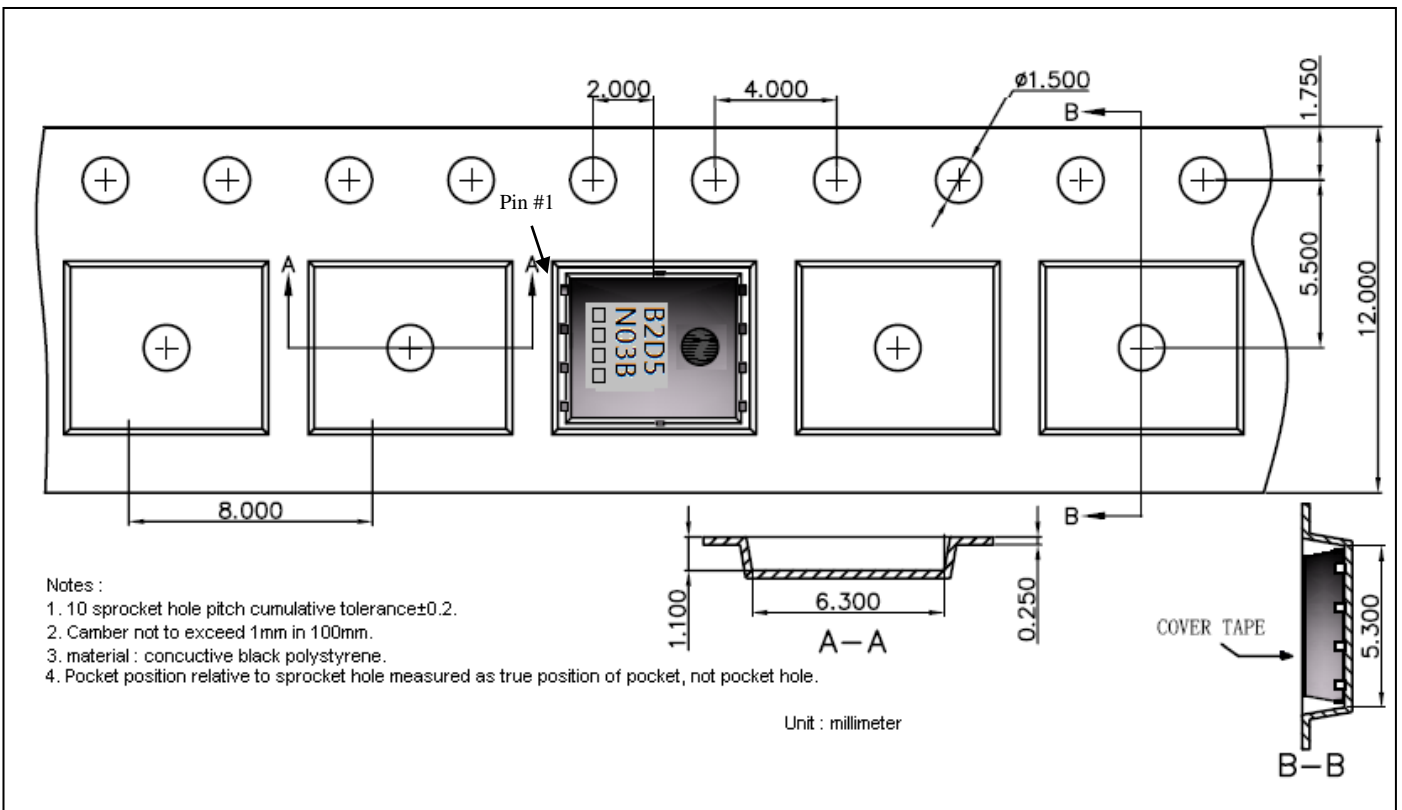

Recommended wave soldering condition

Product	Peak Temperature	Soldering Time
Pb-free devices	260 +0/-5 °C	5 +1/-1 seconds

Recommended temperature profile for IR reflow

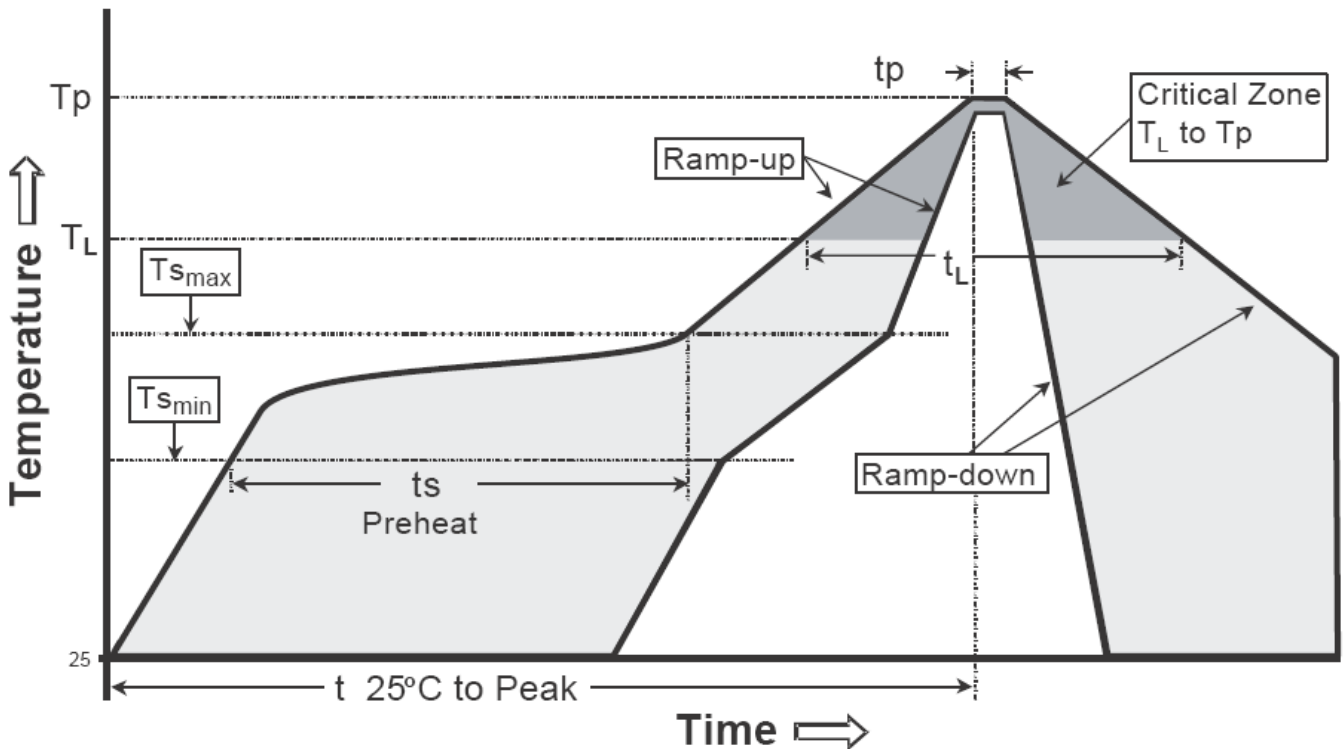

Profile feature	Sn-Pb eutectic Assembly	Pb-free Assembly
Average ramp-up rate (Tsmax to Tp)	3°C/second max.	3°C/second max.
Preheat		
-Temperature Min(Ts min)	100°C	150°C
-Temperature Max(Ts max)	150°C	200°C
-Time(ts min to ts max)	60-120 seconds	60-180 seconds
Time maintained above:		
-Temperature (Tl)	183°C	217°C
- Time (tl)	60-150 seconds	60-150 seconds
Peak Temperature(Tp)	240 +0/-5 °C	260 +0/-5 °C
Time within 5°C of actual peak temperature(tp)	10-30 seconds	20-40 seconds
Ramp down rate	6°C/second max.	6°C/second max.
Time 25 °C to peak temperature	6 minutes max.	8 minutes max.

Note :1. All temperatures refer to topside of the package, measured on the package body surface.
 2. For devices mounted on FR-4 PCB of 1.6mm or equivalent grade PCB. If other grade PCB is used, care should be taken to match the coefficients of thermal expansion between components and PCB. If they are not matched well, the solder joints may crack or the bodies of the parts may crack or shatter as the assembly cools.

DFN5x6 Dimension

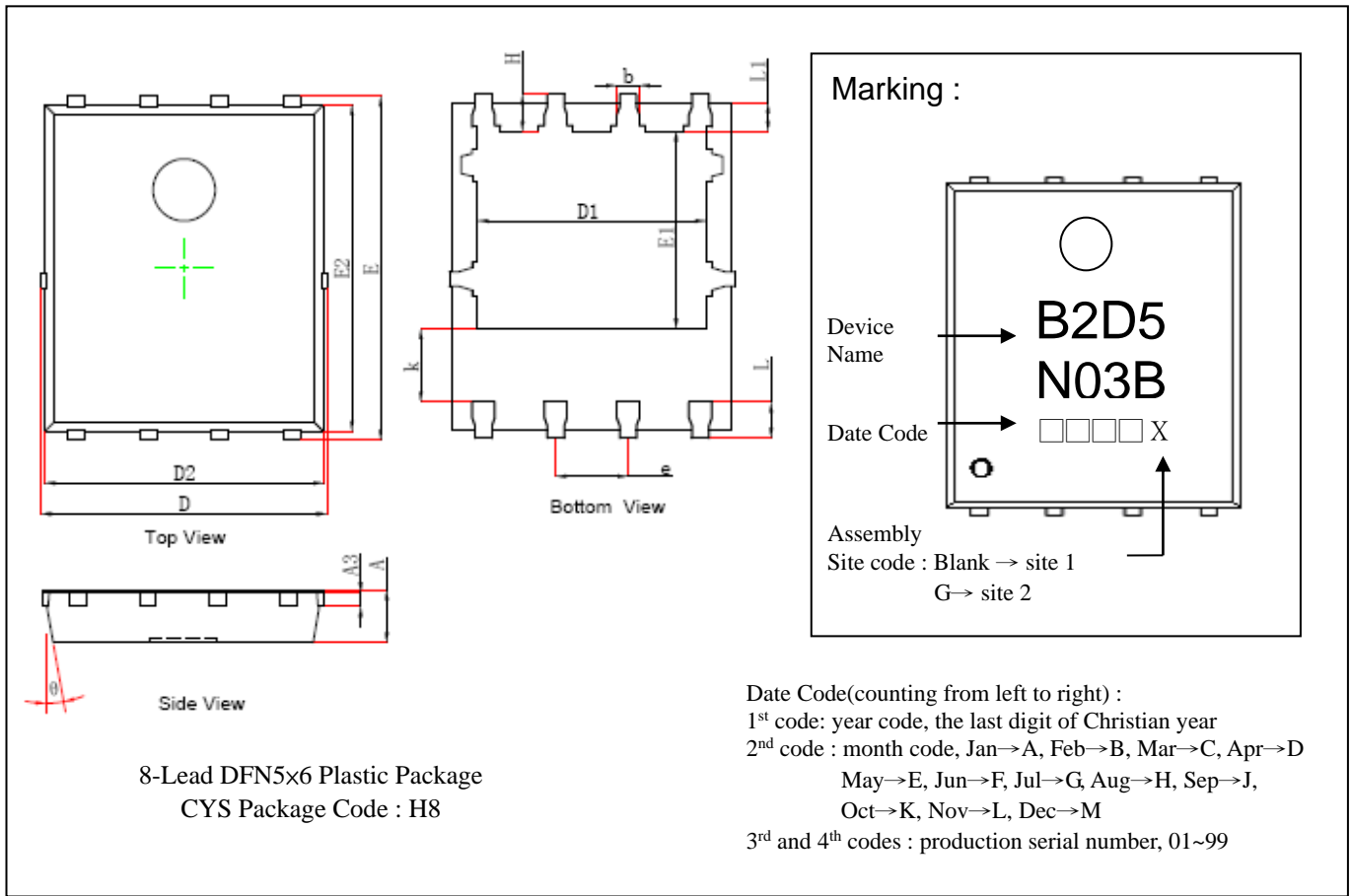

8-Lead DFN5x6 Plastic Package
 CYS Package Code : H8

Marking :

Device Name → B2D5
 N03B
 Date Code → □□□□ X
 Assembly Site code : Blank → site 1
 G → site 2

Date Code(counting from left to right) :
 1st code: year code, the last digit of Christian year
 2nd code : month code, Jan→A, Feb→B, Mar→C, Apr→D
 May→E, Jun→F, Jul→G, Aug→H, Sep→J,
 Oct→K, Nov→L, Dec→M
 3rd and 4th codes : production serial number, 01~99

DIM	Millimeters		Inches		DIM	Millimeters		Inches	
	Min.	Max.	Min.	Max.		Min.	Max.	Min.	Max.
A	0.900	1.100	0.035	0.043	k	1.100	-	0.043	-
A3	0.200	0.300	0.008	0.012	b	0.330	0.510	0.013	0.020
D	4.944	5.096	0.195	0.201	e	1.270	TYP.	0.050	TYP.
E	5.900	6.126	0.232	0.241	L	0.510	0.711	0.020	0.028
D1	3.670	4.110	0.144	0.162	L1	0.310	0.576	0.012	0.023
E1	3.375	3.780	0.133	0.149	H	0.410	0.726	0.016	0.029
D2	4.800	5.000	0.189	0.197	θ	8°	12°	8°	12°
E2	5.674	5.826	0.223	0.229					

Notes: 1.Controlling dimension: millimeters.
 2.Maximum lead thickness includes lead finish thickness, and minimum lead thickness is the minimum thickness of base material.
 3.If there is any question with packing specification or packing method, please contact your local CYStek sales office.

Material:

- Lead: Pure tin plated.
- Mold Compound: Epoxy resin family, flammability solid burning class: UL94V-0.

Important Notice:

- All rights are reserved. Reproduction in whole or in part is prohibited without the prior written approval of CYStek.
- CYStek reserves the right to make changes to its products without notice.
- CYStek **semiconductor products are not warranted to be suitable for use in Life-Support Applications, or systems.**
- CYStek assumes no liability for any consequence of customer product design, infringement of patents, or application assistance.