

N-Channel Enhancement Mode Power MOSFET

MTB2D2N03V8

Features

- Simple drive requirement
- Low on-resistance
- Fast switching speed
- Pb-free lead plating package

BV_{DSS}	30V
$I_D@T_C=25^{\circ}C, V_{GS}=10V$	111A
$I_D@T_A=25^{\circ}C, V_{GS}=10V$	19A
$R_{DS(ON)}@V_{GS}=10V, I_D=20A$	1.7 mΩ (typ.)
$R_{DS(ON)}@V_{GS}=4.5V, I_D=20A$	4.1 mΩ (typ.)

Equivalent Circuit

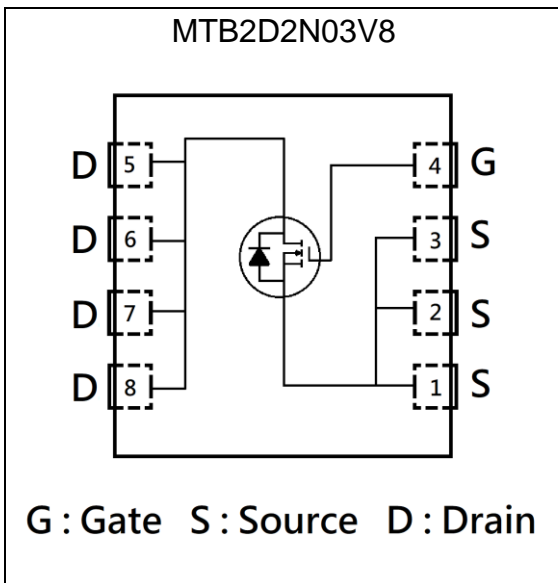

Outline

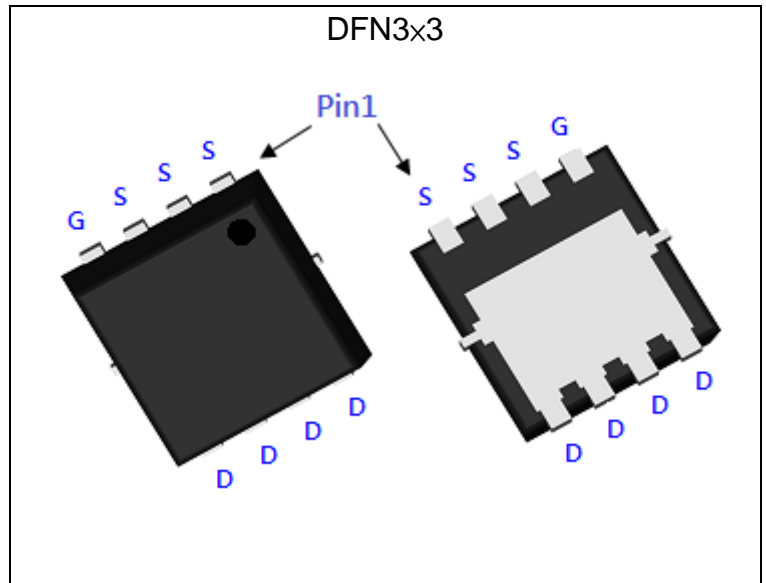

Ordering Information

Device	Package	Shipping
MTB2D2N03V8-0-T6-G	DFN3x3 (Pb-free lead plating and halogen-free package)	3000 pcs / Tape & Reel

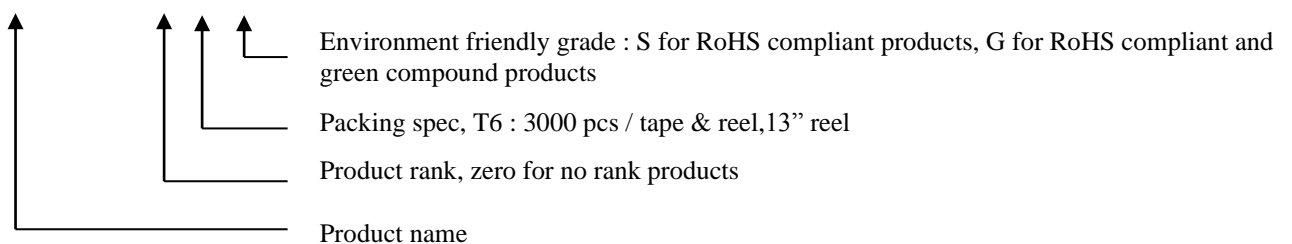



Absolute Maximum Ratings (Ta=25°C)

Parameter	Symbol	Limits	Unit	
Drain-Source Voltage	V _{DS}	30	V	
Gate-Source Voltage	V _{GS}	±20		
Continuous Drain Current @ T _C =25°C, V _{GS} =10V	I _D	111	A	
Continuous Drain Current @ T _C =100°C, V _{GS} =10V		70		
Continuous Drain Current @ T _A =25°C, V _{GS} =10V		19		
Continuous Drain Current @ T _A =70°C, V _{GS} =10V		15		
Pulsed Drain Current	I _{DM}	444 *1		
Avalanche Current @ L=0.1mH	I _{AS}	40		
Avalanche Energy @ L=0.5mH	E _{AS}	156 *4	mJ	
Total Power Dissipation	P _D	T _C =25°C	62	W
		T _C =100°C	25	
		T _A =25°C	1.9 *3	
		T _A =70°C	1.2 *3	
Operating Junction and Storage Temperature Range	T _J , T _{stg}	-55~+150	°C	

Thermal Data

Parameter	Symbol	Value	Unit
Thermal Resistance, Junction-to-case, max	R _{θJC}	2	°C/W
Thermal Resistance, Junction-to-ambient, max	R _{θJA}	67 *3	

- Note : 1. Pulse width limited by maximum junction temperature
 2. Duty cycle ≤ 1%
 3. Surface mounted on 1 in² copper pad of FR-4 board, t ≤ 10s ; 125°C/W when mounted on minimum copper pad.

Electrical Characteristics (T_J=25°C, unless otherwise specified)

Symbol	Min.	Typ.	Max.	Unit	Test Conditions
Static					
BV _{DSS}	30	-	-	V	V _{GS} =0V, I _D =250μA
V _{GS(th)}	1	-	2.5		V _{DS} =V _{GS} , I _D =250μA
I _{GSS}	-	-	±100	nA	V _{GS} =±20V, V _{DS} =0V
I _{DSS}	-	-	1	μA	V _{DS} =24V, V _{GS} =0V
	-	-	5		V _{DS} =24V, V _{GS} =0V, T _j =55°C
R _{DS(ON)} *1	-	1.7	2.5	mΩ	V _{GS} =10V, I _D =20A
	-	4.1	6		V _{GS} =4.5V, I _D =20A
G _{FS} *1	-	45	-	S	V _{DS} =5V, I _D =20A

Electrical Characteristics(Cont.) (T_J=25°C, unless otherwise specified)

Symbol	Min.	Typ.	Max.	Unit	Test Conditions
Dynamic					
C _{iss}	-	3400	-	pF	V _{DS} =15V, V _{GS} =0V, f=1MHz
C _{oss}	-	445	-		
C _{rss}	-	350	-		
Q _g *1, 2	-	36	-	nC	V _{DS} =15V, I _D =20A, V _{GS} =4.5V
Q _{gs} *1, 2	-	11	-		
Q _{gd} *1, 2	-	18	-		
t _{d(ON)} *1, 2	-	18	-	ns	V _{DS} =15V, I _D =20A, V _{GS} =10V R _G =3Ω
t _r *1, 2	-	22	-		
t _{d(OFF)} *1, 2	-	72	-		
t _f *1, 2	-	16	-		
R _g	-	1.2	-	Ω	f=1MHz
Source-Drain Diode					
I _S *1	-	-	20	A	
I _{SM} *3	-	-	80		
V _{SD} *1	-	0.83	1.2	V	I _F =10A, V _{GS} =0V
t _{rr}	-	18	-	ns	I _F =20A, dI _F /dt=100A/μs
Q _{rr}	-	12	-	nC	

Note : *1.Pulse Test : Pulse Width ≤300μs, Duty Cycle≤2%
 *2.Independent of operating temperature
 *3.Pulse width limited by maximum junction temperature.

Recommended Soldering Footprint

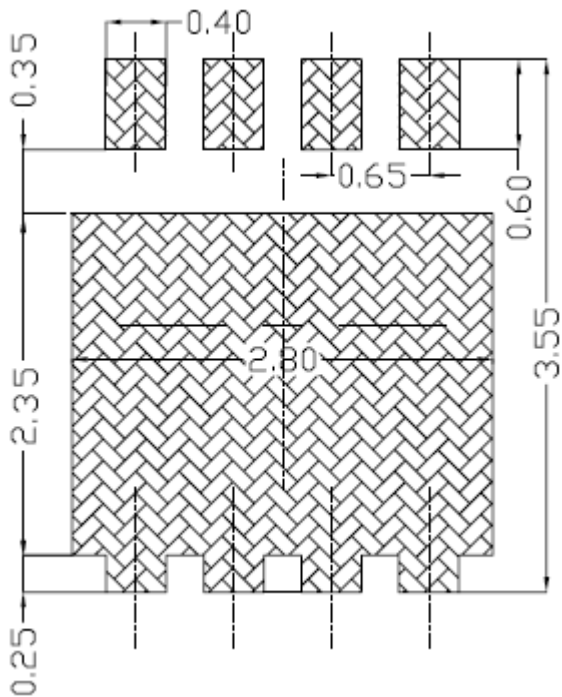

unit : mm



Typical Characteristics

Typical Output Characteristics

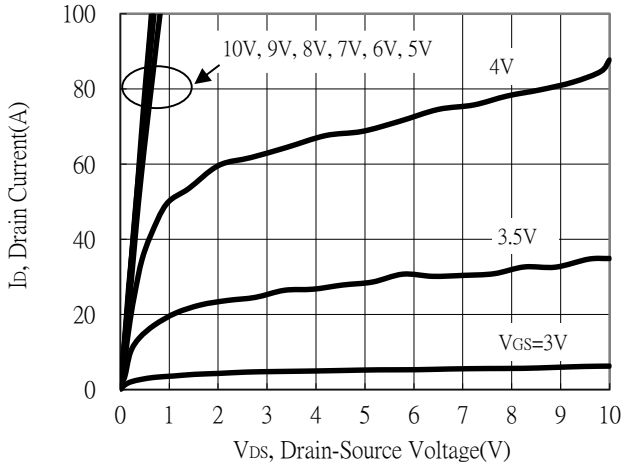

Breakdown Voltage vs Ambient Temperature

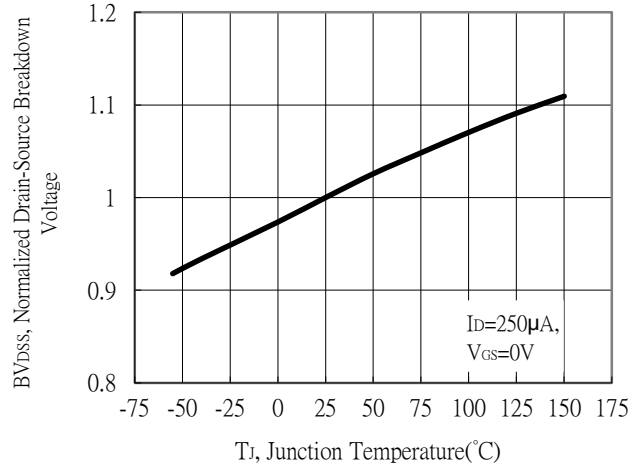

Static Drain-Source On-State resistance vs Drain Current

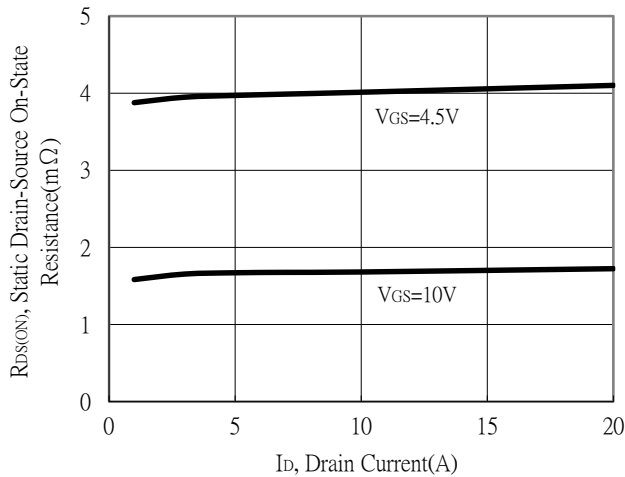

Reverse Drain Current vs Source-Drain Voltage

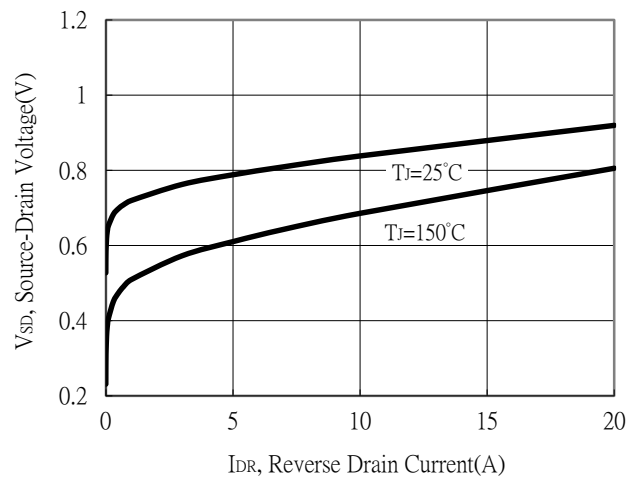

Static Drain-Source On-State Resistance vs Gate-Source Voltage

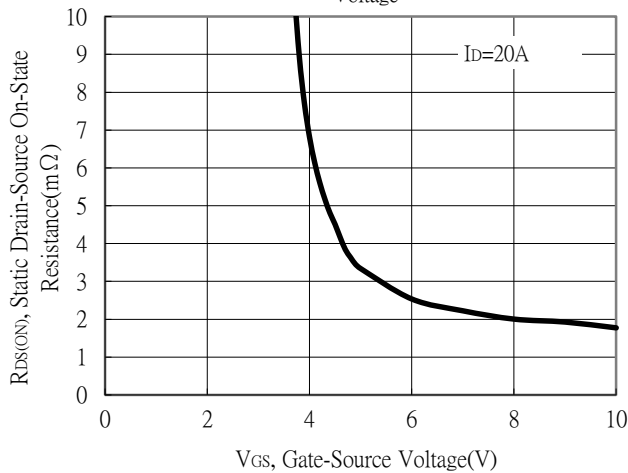

Drain-Source On-State Resistance vs Junction Temperature

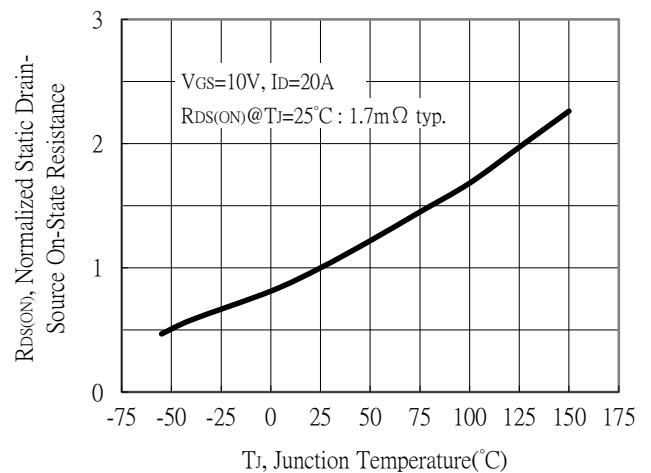

Typical Characteristics(Cont.)

Capacitance vs Drain-to-Source Voltage

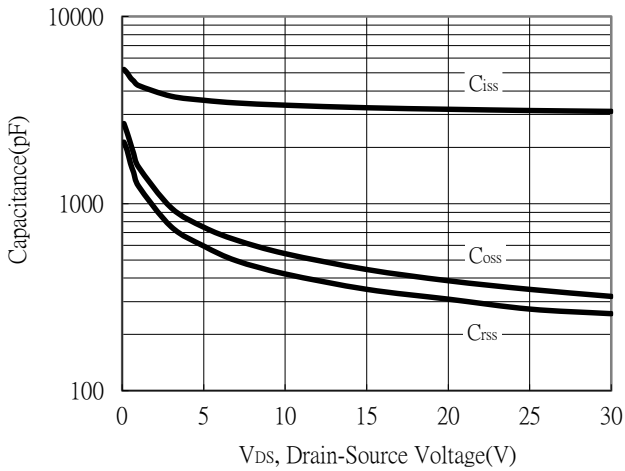

Threshold Voltage vs Junction Temperature

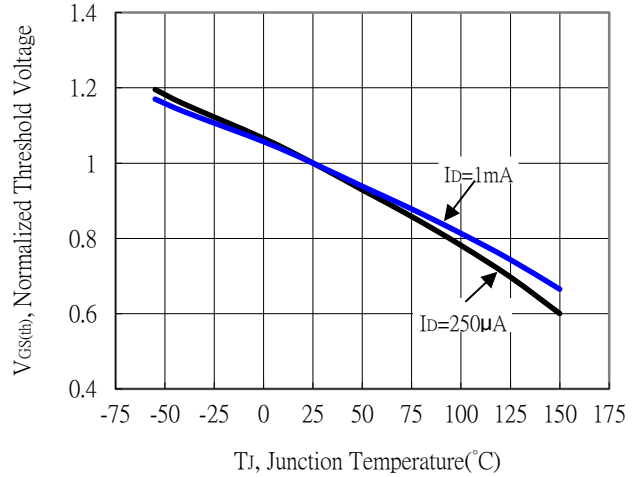

Forward Transfer Admittance vs Drain Current

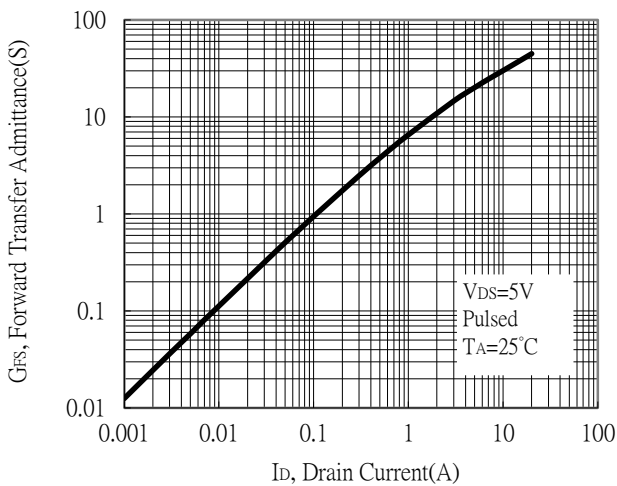

Gate Charge Characteristics

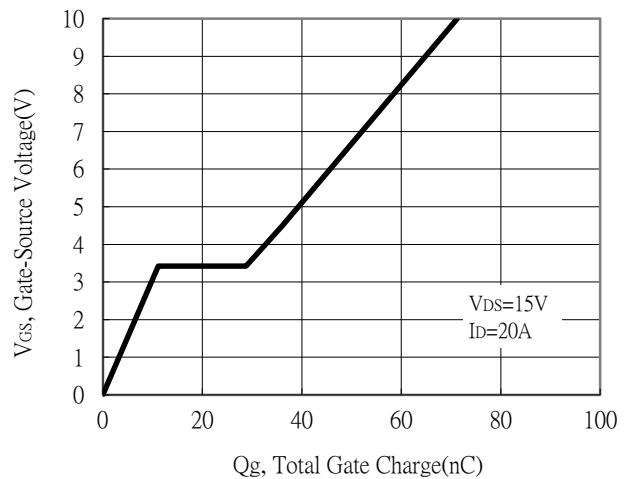

Maximum Safe Operating Area

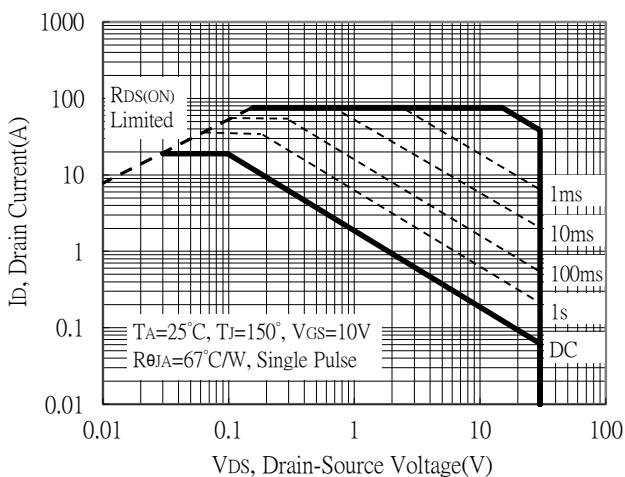

Maximum Safe Operating Area

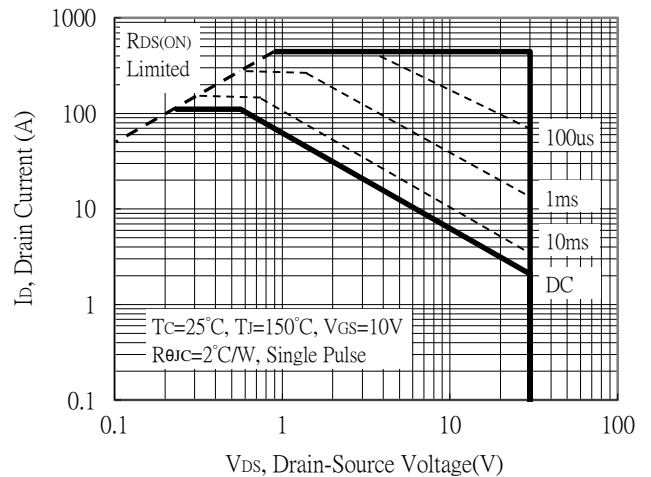

Typical Characteristics(Cont.)

Maximum Drain Current vs Junction Temperature

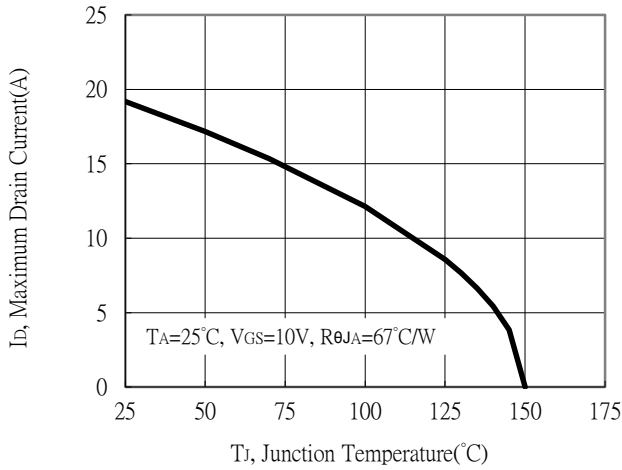

Maximum Drain Current vs Case Temperature

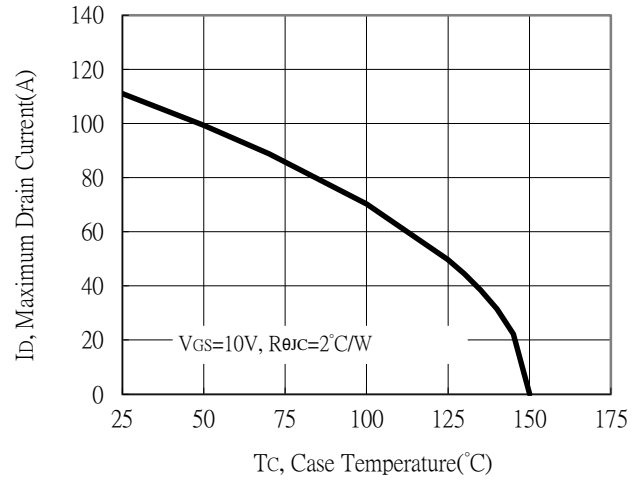

Single Pulse Power Rating, Junction to Ambient
 (Note on page 2)

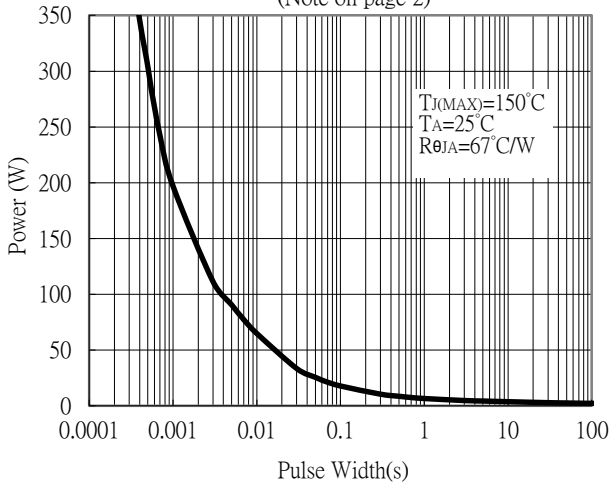

Single Pulse Maximum Power Dissipation

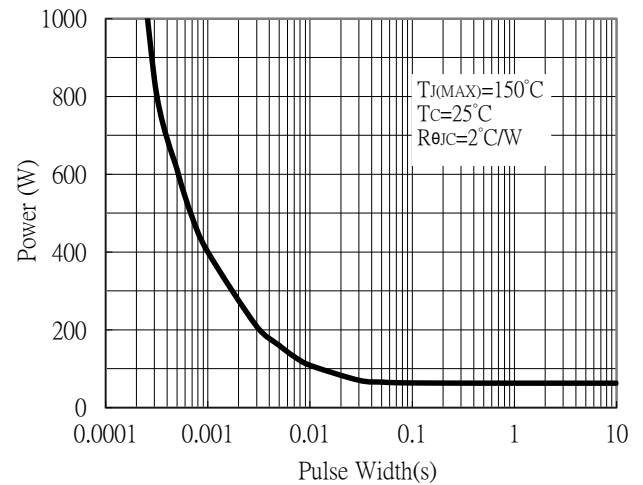

Typical Characteristics(Cont.)

Transient Thermal Response Curves

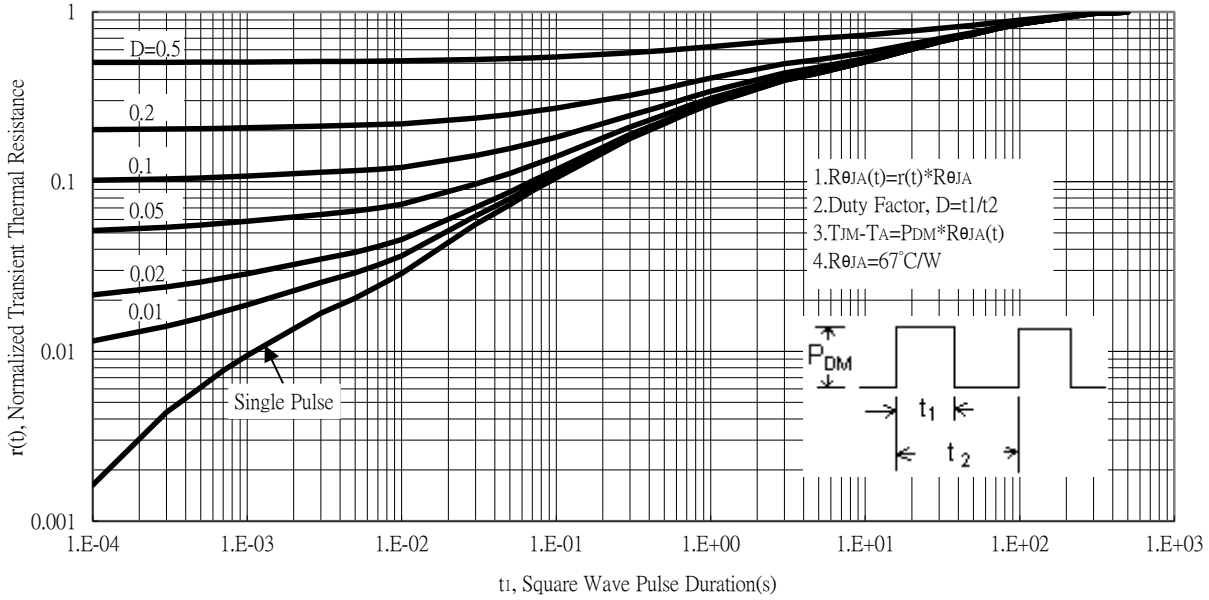

Transient Thermal Response Curves

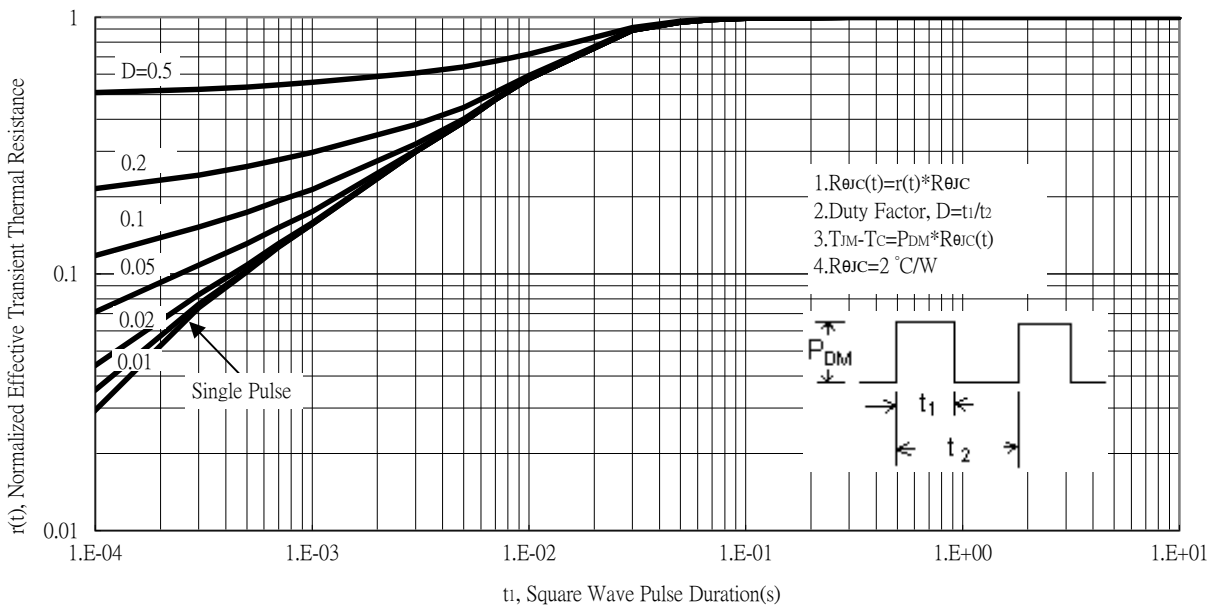

Reel Dimension

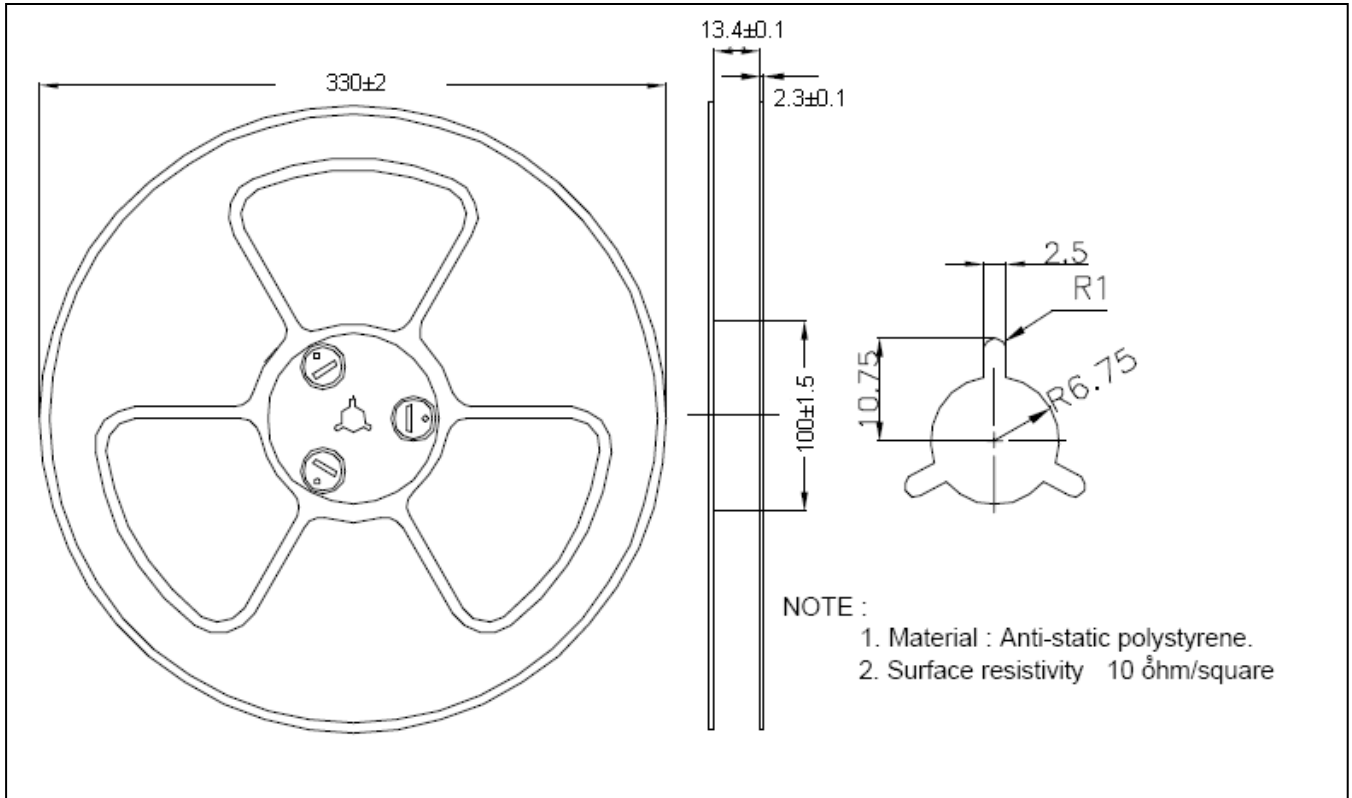

Carrier Tape Dimension

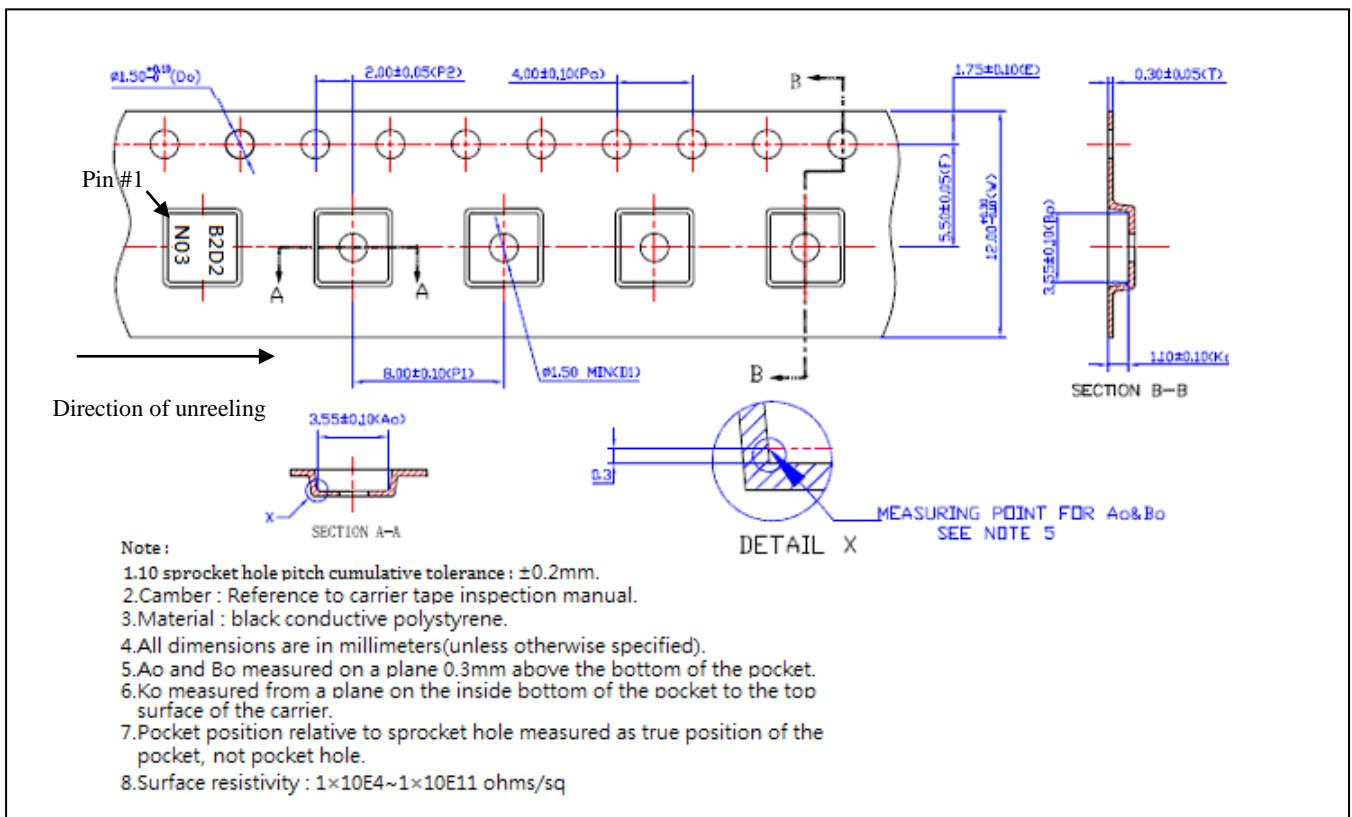

Recommended wave soldering condition

Product	Peak Temperature	Soldering Time
Pb-free devices	260 +0/-5 °C	5 +1/-1 seconds

Recommended temperature profile for IR reflow

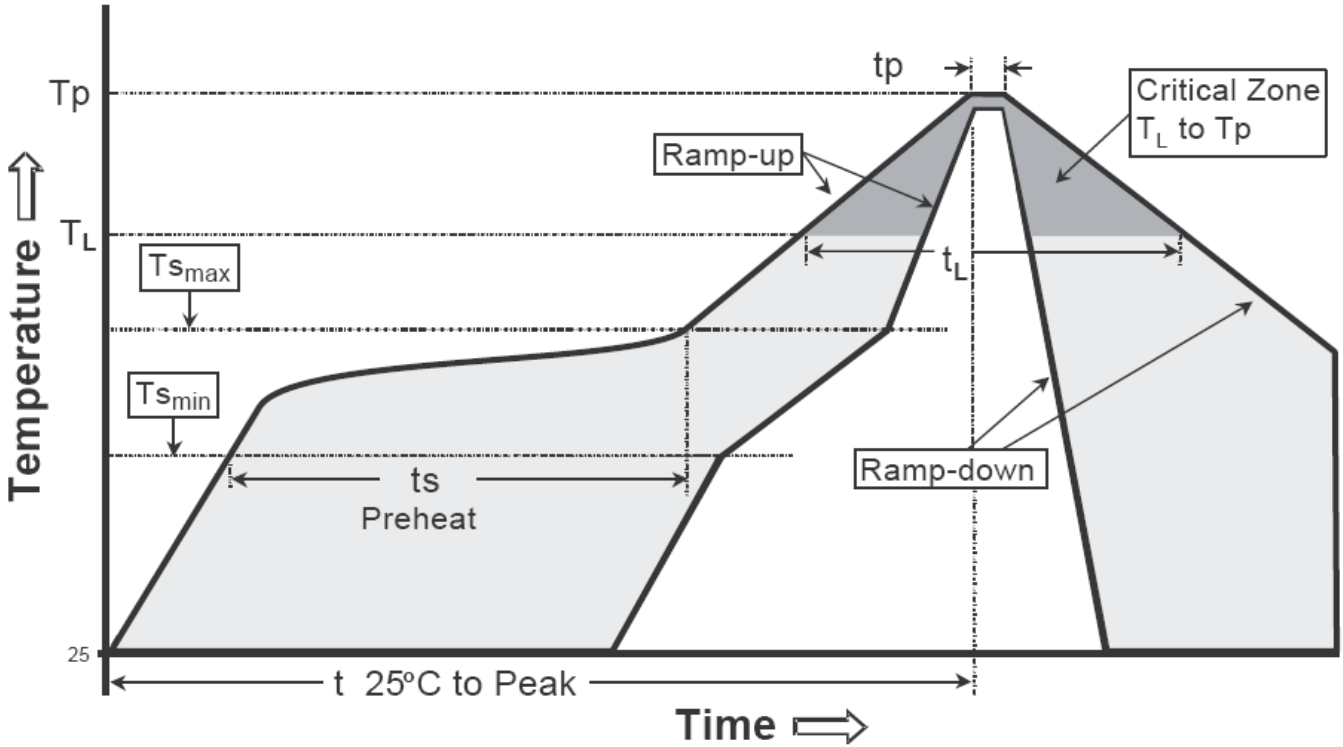

Profile feature	Sn-Pb eutectic Assembly	Pb-free Assembly
Average ramp-up rate (T _{smax} to T _p)	3°C/second max.	3°C/second max.
Preheat		
-Temperature Min(T _{s min})	100°C	150°C
-Temperature Max(T _{s max})	150°C	200°C
-Time(t _{s min} to t _{s max})	60-120 seconds	60-180 seconds
Time maintained above:		
-Temperature (T _L)	183°C	217°C
- Time (t _L)	60-150 seconds	60-150 seconds
Peak Temperature(T _P)	240 +0/-5 °C	260 +0/-5 °C
Time within 5°C of actual peak temperature(tp)	10-30 seconds	20-40 seconds
Ramp down rate	6°C/second max.	6°C/second max.
Time 25 °C to peak temperature	6 minutes max.	8 minutes max.

Note :1. All temperatures refer to topside of the package, measured on the package body surface.
 2. For devices mounted on FR-4 PCB of 1.6mm or equivalent grade PCB. If other grade PCB is used, care should be taken to match the coefficients of thermal expansion between components and PCB. If they are not matched well, the solder joints may crack or the bodies of the parts may crack or shatter as the assembly cools.

DFN3x3 Dimension

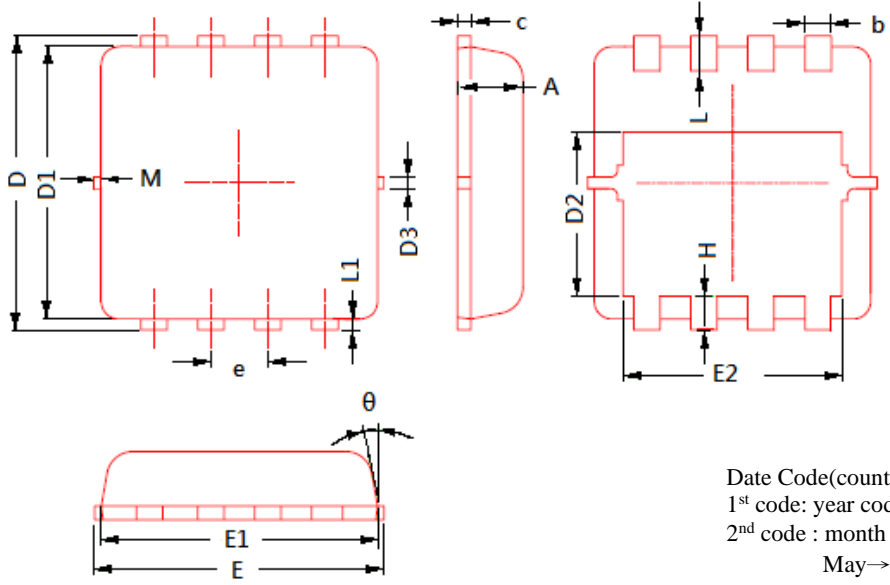

Marking:

D D D D

B2D2

N03

Date Code → □ □ □ □ (G) ←

S S S G

Assembly site code :
 blank → JCET
 G → GEM

Date Code(counting from left to right) :
 1st code: year code, the last digit of Christian year
 2nd code : month code, Jan→A, Feb→B, Mar→C, Apr→D
 May→E, Jun→F, Jul→G, Aug→H, Sep→J,
 Oct→K, Nov→L, Dec→M
 3rd and 4th codes : production serial number, 01~99

8-Lead DFN3x3 Plastic Package
 CYStek Package Code: V8

DIM	Millimeters		Inches		DIM	Millimeters		Inches	
	Min.	Max.	Min.	Max.		Min.	Max.	Min.	Max.
A	0.70	0.80	0.028	0.031	E1	3.00	3.20	0.118	0.126
b	0.25	0.35	0.010	0.014	E2	2.39	2.59	0.094	0.102
c	0.10	0.25	0.004	0.010	e	0.65 BSC		0.026 BSC	
D	3.25	3.45	0.128	0.136	H	0.30	0.50	0.012	0.020
D1	3.00	3.20	0.118	0.126	L	0.30	0.50	0.012	0.020
D2	1.78	1.98	0.070	0.078	L1	0.13 TYP		0.005 TYP	
D3	0.13 TYP		0.005 TYP		θ	-	12°	-	12°
E	3.20	3.40	0.126	0.134	M	-	0.15	-	0.006

Notes: 1.Controlling dimension: millimeters.
 2.Maximum lead thickness includes lead finish thickness, and minimum lead thickness is the minimum thickness of base material.
 3.If there is any question with packing specification or packing method, please contact your local CYStek sales office.

Material:

- Lead: pure tin plated.
- Mold Compound: Epoxy resin family, flammability solid burning class: UL94V-0.

Important Notice:

- All rights are reserved. Reproduction in whole or in part is prohibited without the prior written approval of CYStek.
- CYStek reserves the right to make changes to its products without notice.
- CYStek **semiconductor products are not warranted to be suitable for use in Life-Support Applications, or systems.**
- CYStek assumes no liability for any consequence of customer product design, infringement of patents, or application assistance.