

Product Summary

BV_{DSS}	-30	V
$R_{DS(ON)}$ typ. @ $V_{GS}=-10V, I_D=-3A$	35	m Ω
$R_{DS(ON)}$ typ. @ $V_{GS}=-4.5V, I_D=-2A$	72	
I_D @ $V_{GS}=-10V, T_A=25^\circ C$	-3.3	A

Features

- Low Gate Charge
- Fast Switching Characteristic
- Pb-free lead plating and halogen-free

SOT-23

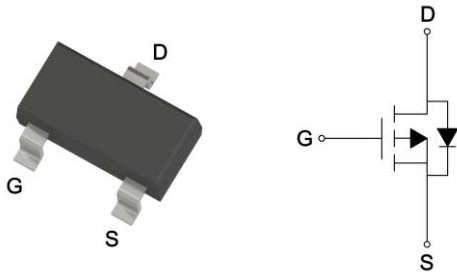

Marking

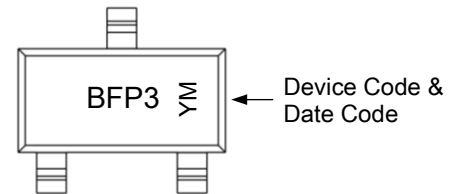

YM: Date Code Marking

Y: Year Code, the last digit of Christian year

M: Month Code

1: Jan	2: Feb	3: Mar	4: Apr	5: May	6: Jun
7: Jul	8: Aug	9: Sep	A: Oct	B: Nov	C: Dec

Ordering Information

Device	Package	Shipping
MTB040P03SN3-0-T1-G	SOT-23	3000pcs / Tape & Reel

0: Product rank, zero for no rank products.

T1: Packing spec, T1 : 3000pcs / tape & reel, 7" reel

G: Environment friendly grade: S for RoHS compliant products, G for RoHS compliant and green compound products.

Absolute Maximum Ratings ($T_A=25^\circ C$)

Parameter	Symbol	Value	Unit	
Drain-Source Voltage	V_{DS}	-30	V	
Gate-Source Voltage	V_{GS}	± 25		
Continuous Drain Current @ $V_{GS}=-10V, T_A=25^\circ C$	I_D	-3.3	A	
Continuous Drain Current @ $V_{GS}=-10V, T_A=70^\circ C$		-2.6		
Pulsed Drain Current	I_{DM}	-13.2		
Continuous Body Diode Forward Current @ $T_A=25^\circ C$	I_S	-0.7		
Pulsed Body Diode Forward Current @ $T_A=25^\circ C$	I_{SM}	-2.8		
Total Power Dissipation	P_D	$T_A=25^\circ C$	0.8	W
		$T_A=70^\circ C$	0.5	
Operating Junction and Storage Temperature Range	T_J, T_{stg}	-55~+150	$^\circ C$	
Steady State Thermal Resistance, Junction-to-Ambient	$R_{\theta JA}$	163	$^\circ C/W$	



Electrical Characteristics (T_A=25°C, unless otherwise specified)

Symbol	Min.	Typ.	Max.	Unit	Test Conditions
Static					
BV _{DSS}	-30	-	-	V	V _{GS} =0V, I _D =-250μA
V _{GS(th)}	-1	-	-2.5		V _{DS} =V _{GS} , I _D =-250μA
G _{FS}	-	4	-	S	V _{DS} =-10V, I _D =-3A
I _{GSS}	-	-	±100	nA	V _{GS} =±25V, V _{DS} =0V
I _{DSS}	-	-	-1	μA	V _{DS} =-24V, V _{GS} =0V
R _{DS(ON)}	-	35	46	mΩ	V _{GS} =-10V, I _D =-3A
	-	72	100		V _{GS} =-4.5V, I _D =-2A
Dynamic					
C _{iSS}	-	500	-	pF	V _{DS} =-15V, V _{GS} =0V, f=1MHz
C _{oss}	-	95	-		
C _{rSS}	-	80	-		
R _g	-	18	-	Ω	f=1MHz
Q _g *c,d	-	5.5	-	nC	V _{DS} =-15V, I _D =-3A, V _{GS} =-4.5V
Q _g *c,d	-	10.5	-		
Q _{gs} *c,d	-	1.8	-		
Q _{gd} *c,d	-	2.4	-		
t _{d(ON)} *c,d	-	5.7	-	ns	V _{DS} =-15V, I _D =-3A, V _{GS} =-10V, R _{GS} =1Ω
t _r *c,d	-	16	-		
t _{d(OFF)} *c,d	-	34	-		
t _f *c,d	-	13	-		
Source-Drain Diode					
V _{SD} *c	-	-0.84	-1.2	V	I _S =-3A, V _{GS} =0V
t _{rr}	-	7	-	ns	I _F =-3A, di/dt=100A/μs
Q _{rr}	-	2.2	-	nC	

Note:

- *a. The value of R_{θJA} is measured with the device mounted on 1in² FR-4 board with 2oz copper, in a still air environment with T_A=25°C. The power dissipation P_D is based on R_{θJA} and the maximum allowed junction temperature of 150°C. The value in any given application depends on the user's specific board design.
- *b. Repetitive rating, pulse width limited by junction temperature T_{J(MAX)}=150°C. Ratings are based on low frequency and low duty cycles to keep initial T_J=25°C.
- *c. Pulse Test : Pulse Width≤300μs, Duty Cycle≤2%.
- *d. Independent of operating temperature.

Typical Characteristics

Typical Output Characteristics

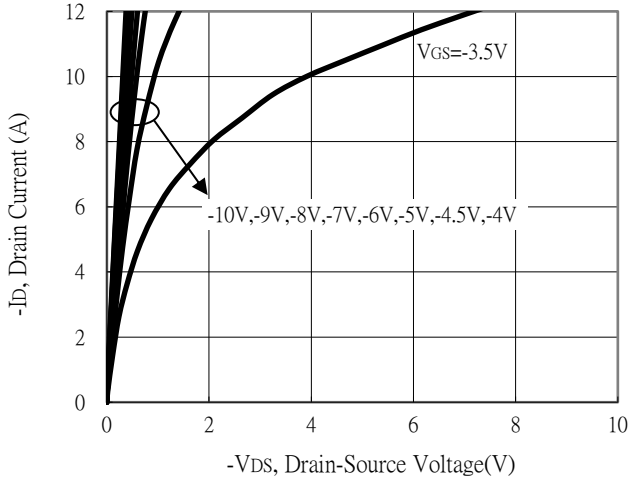

Breakdown Voltage vs Ambient Temperature

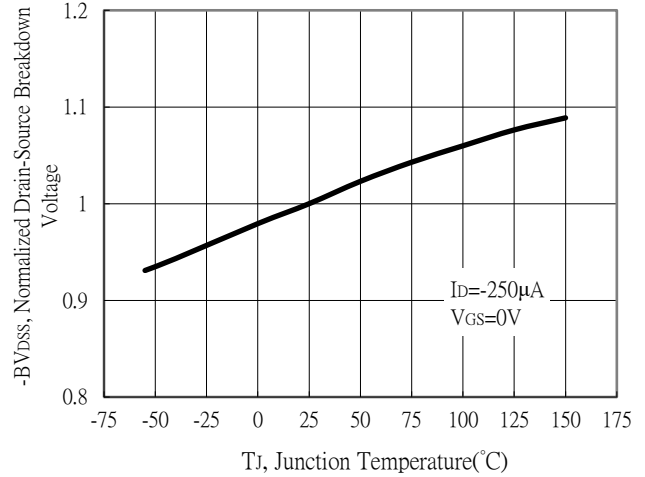

Static Drain-Source On-State resistance vs Drain Current

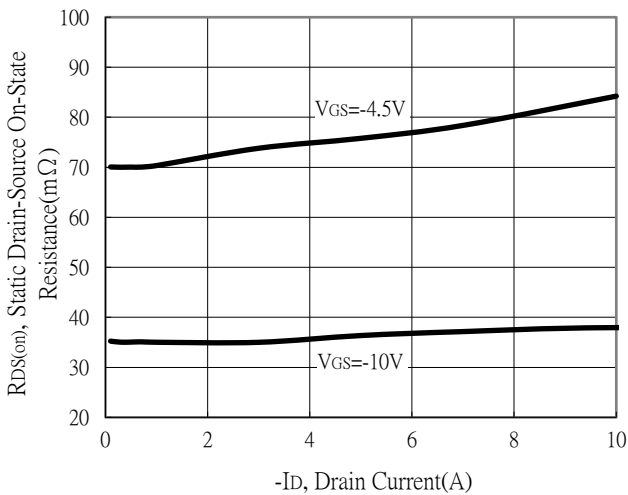

Body Diode Current vs Source-Drain Voltage

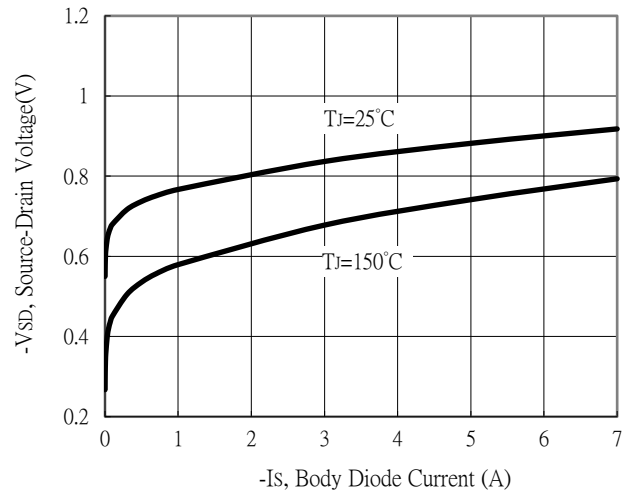

Static Drain-Source On-State Resistance vs Gate-Source Voltage

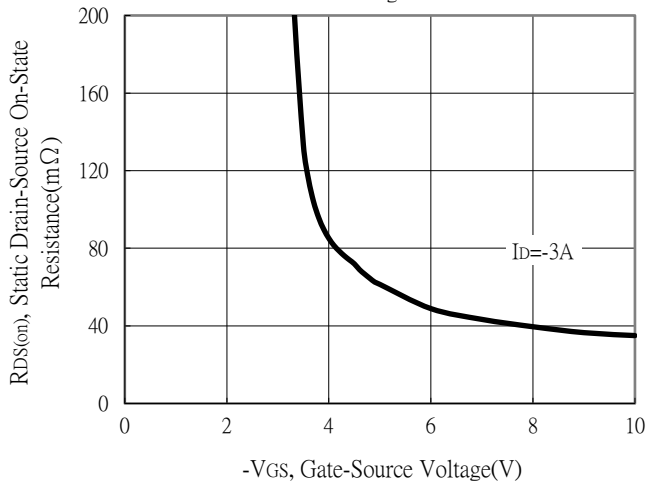

Drain-Source On-State Resistance vs Junction Temperature

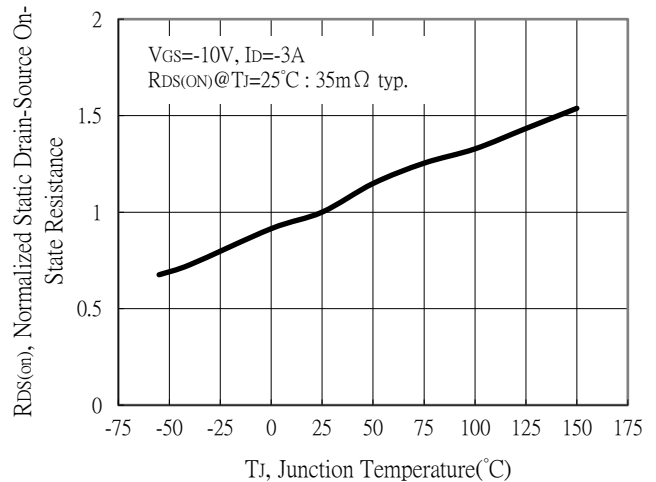

Typical Characteristics

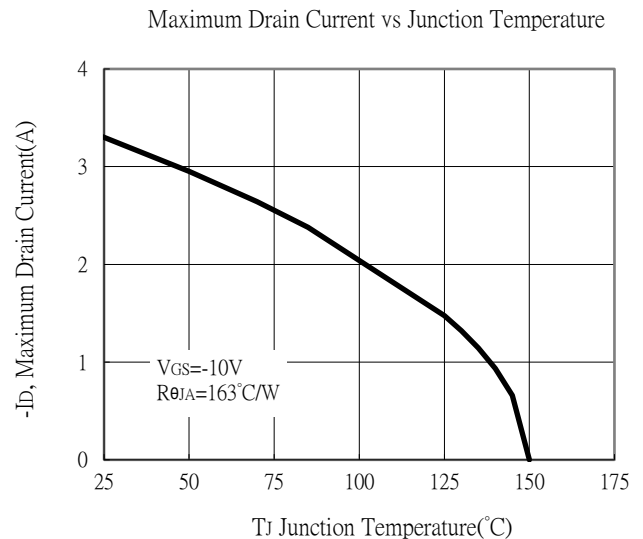
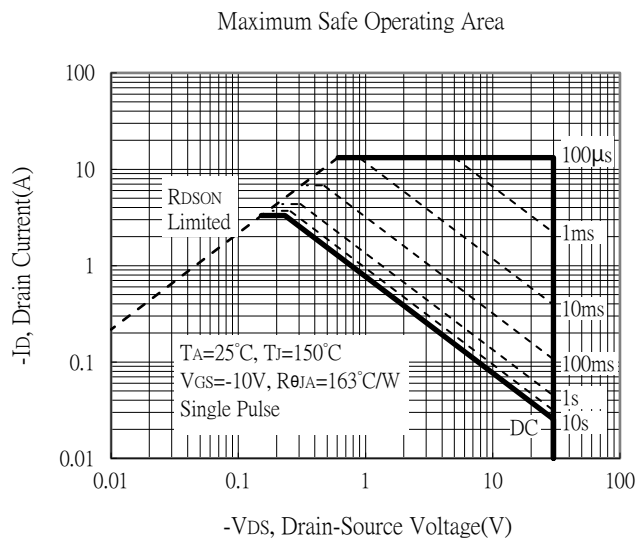
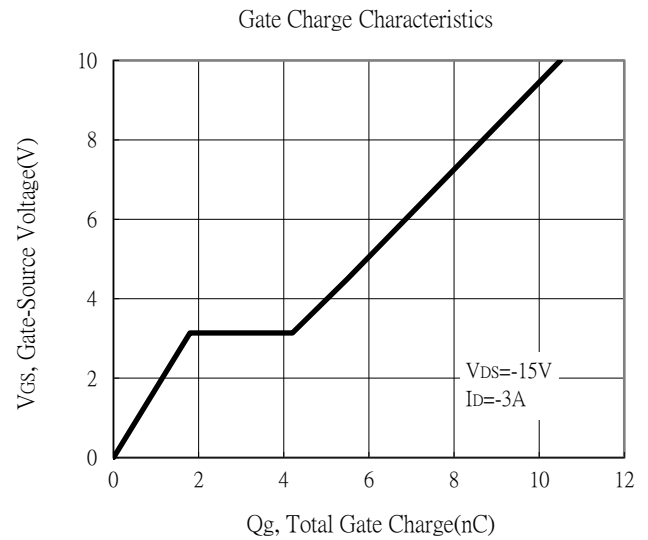
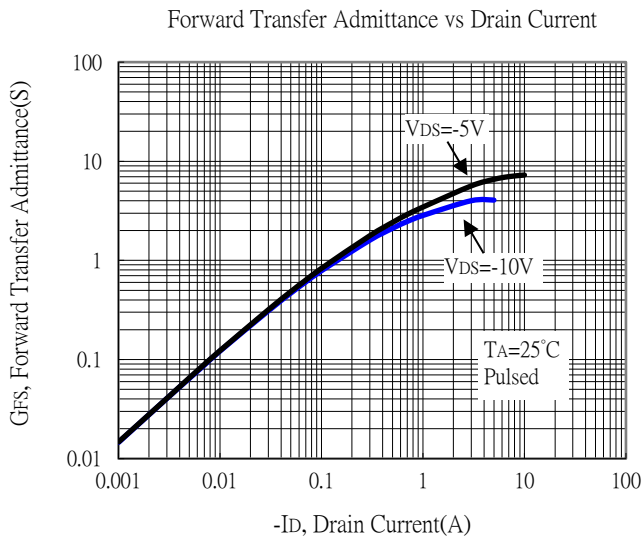
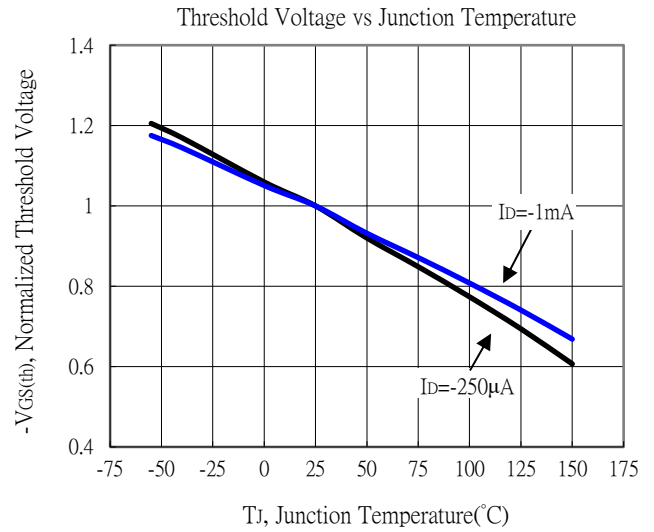
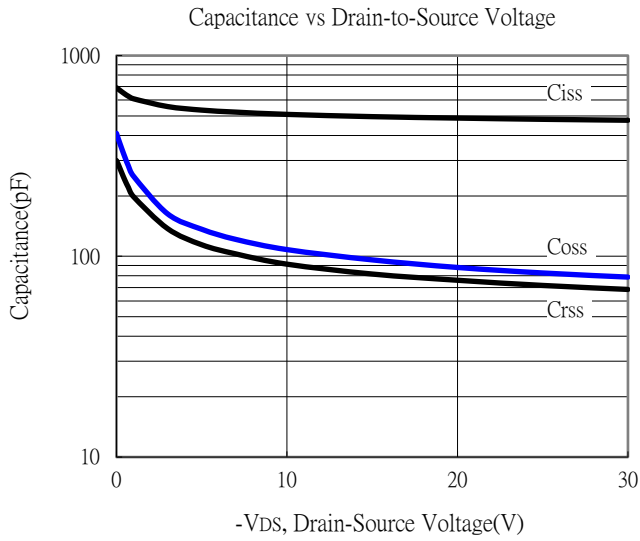

Typical Characteristics

Single Pulse Power Rating, Junction to Ambient

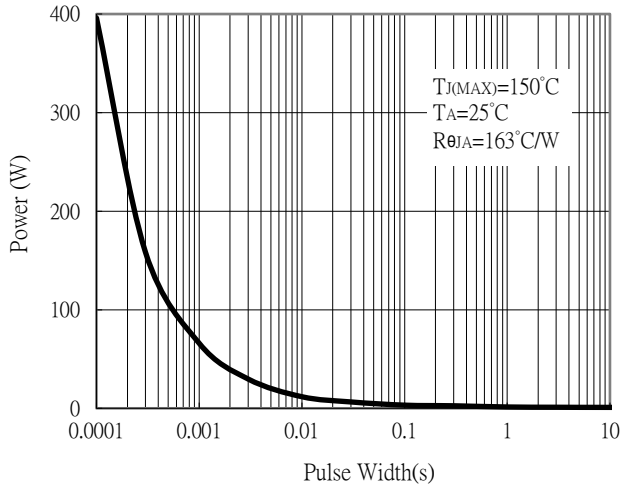

Transient Thermal Response Curves

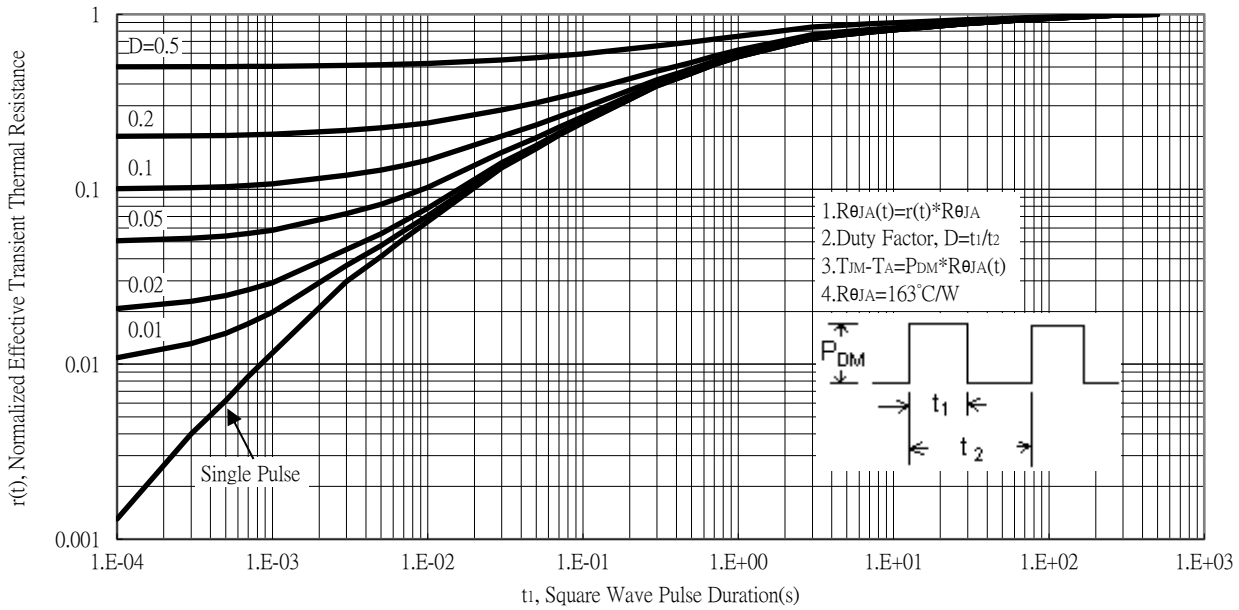

SOT-23 Dimension

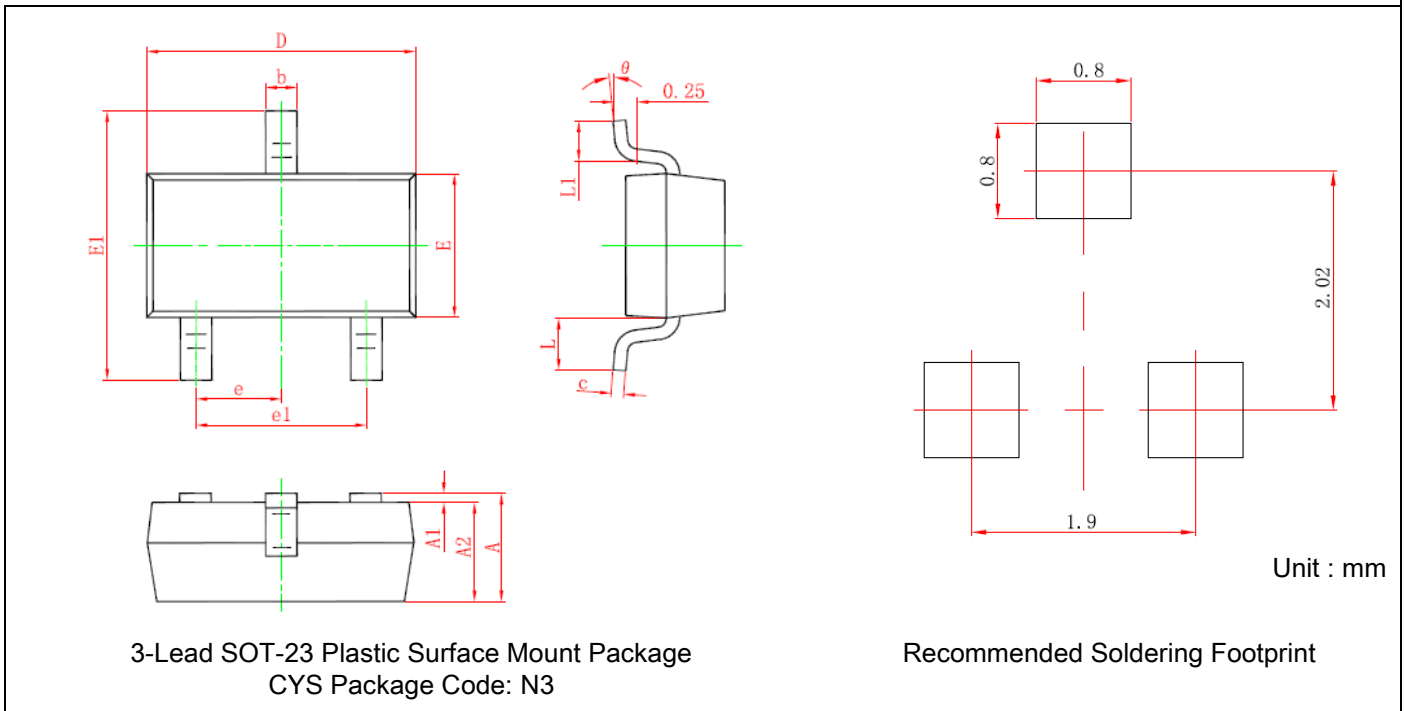

DIM	Inches		Millimeters		DIM	Inches		Millimeters	
	Min.	Max.	Min.	Max.		Min.	Max.	Min.	Max.
A	0.035	0.045	0.900	1.150	E1	0.089	0.100	2.250	2.550
A1	0.000	0.004	0.000	0.100	e	0.037	TYP.	0.095	TYP.
A2	0.035	0.041	0.900	1.050	e1	0.071	0.079	1.800	2.000
b	0.012	0.020	0.300	0.500	L	0.022	REF.	0.550	REF.
c	0.003	0.006	0.080	0.150	L1	0.012	0.020	0.300	0.500
D	0.110	0.118	2.800	3.000	θ	0°	8°	0°	8°
E	0.047	0.055	1.200	1.400					

Note:

- Controlling dimension: millimeters.
- Maximum lead thickness includes lead finish thickness, and minimum lead thickness is the minimum thickness of base material.
- If there is any question with packing specification or packing method, please contact your local CYStek sales office.

Material:

- Lead: pure tin plated.
- Mold Compound: Epoxy resin family, flammability solid burning class: UL94V-0.

Important Notice:

- All rights are reserved. Reproduction in whole or in part is prohibited without the prior written approval of CYStek.
- CYStek reserves the right to make changes to its products without notice.
- CYStek semiconductor products are not warranted to be suitable for use in Life-Support Applications, or systems.
- CYStek assumes no liability for any consequence of customer product design, infringement of patents, or application assistance.

Reel Dimension

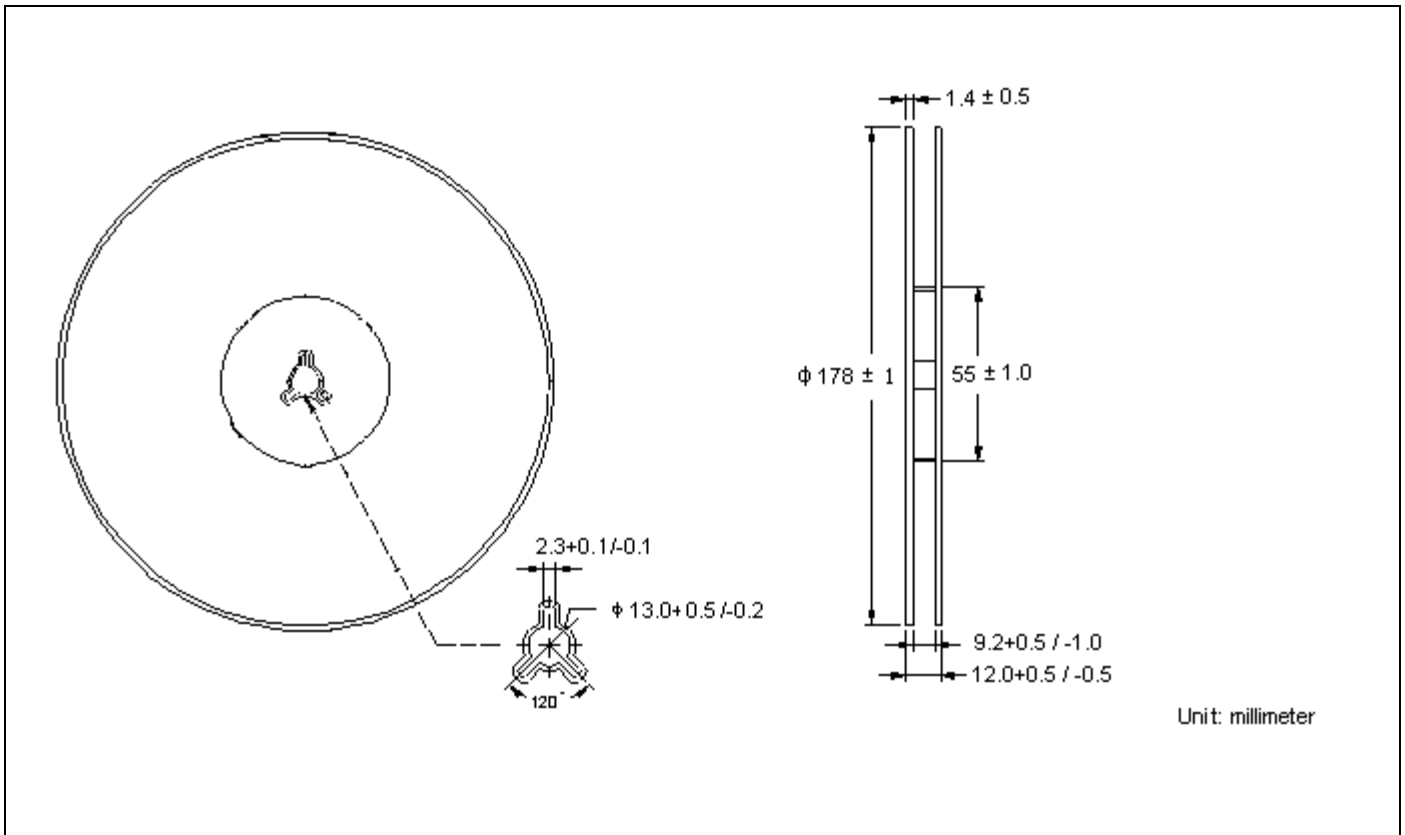

Carrier Tape Dimension

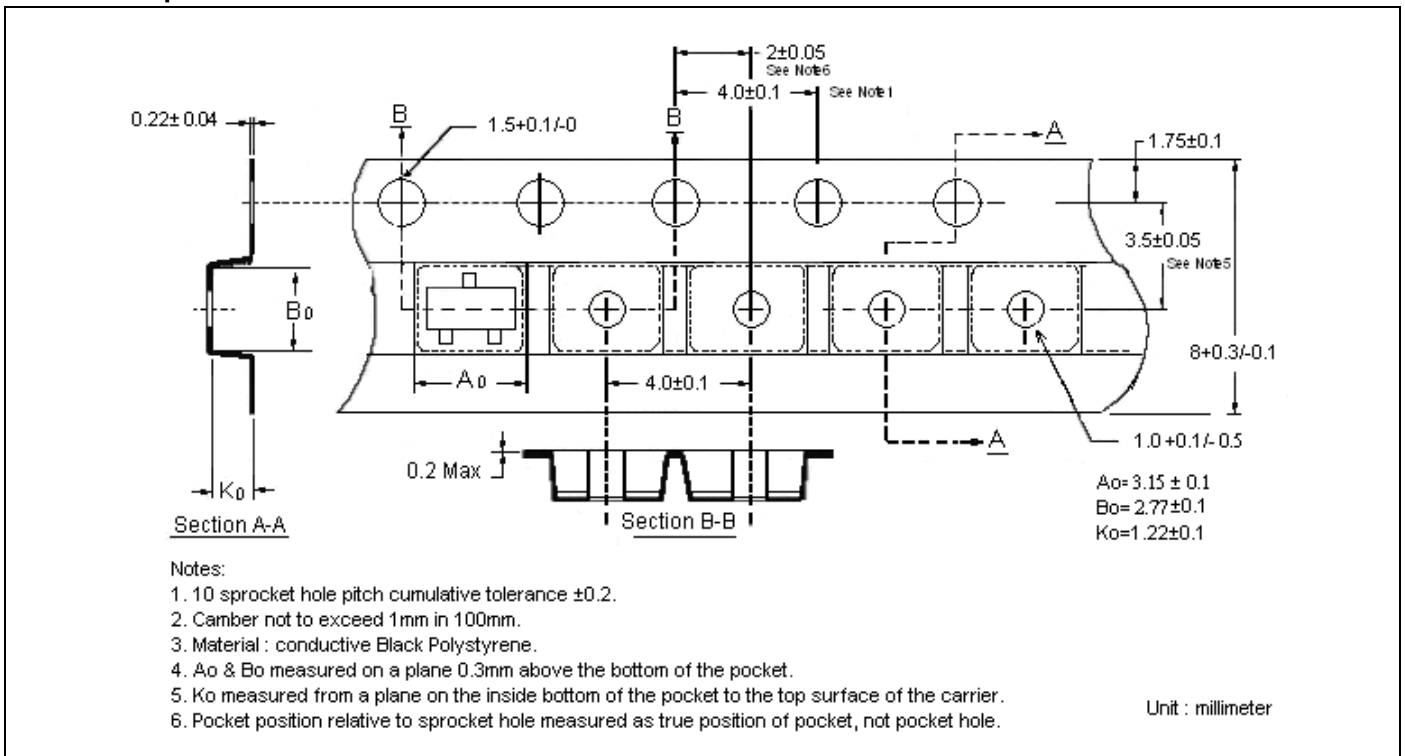

Recommended wave soldering condition

Product	Peak Temperature	Soldering Time
Pb-free devices	260 +0/-5 °C	5 +1/-1 seconds

Recommended temperature profile for IR reflow

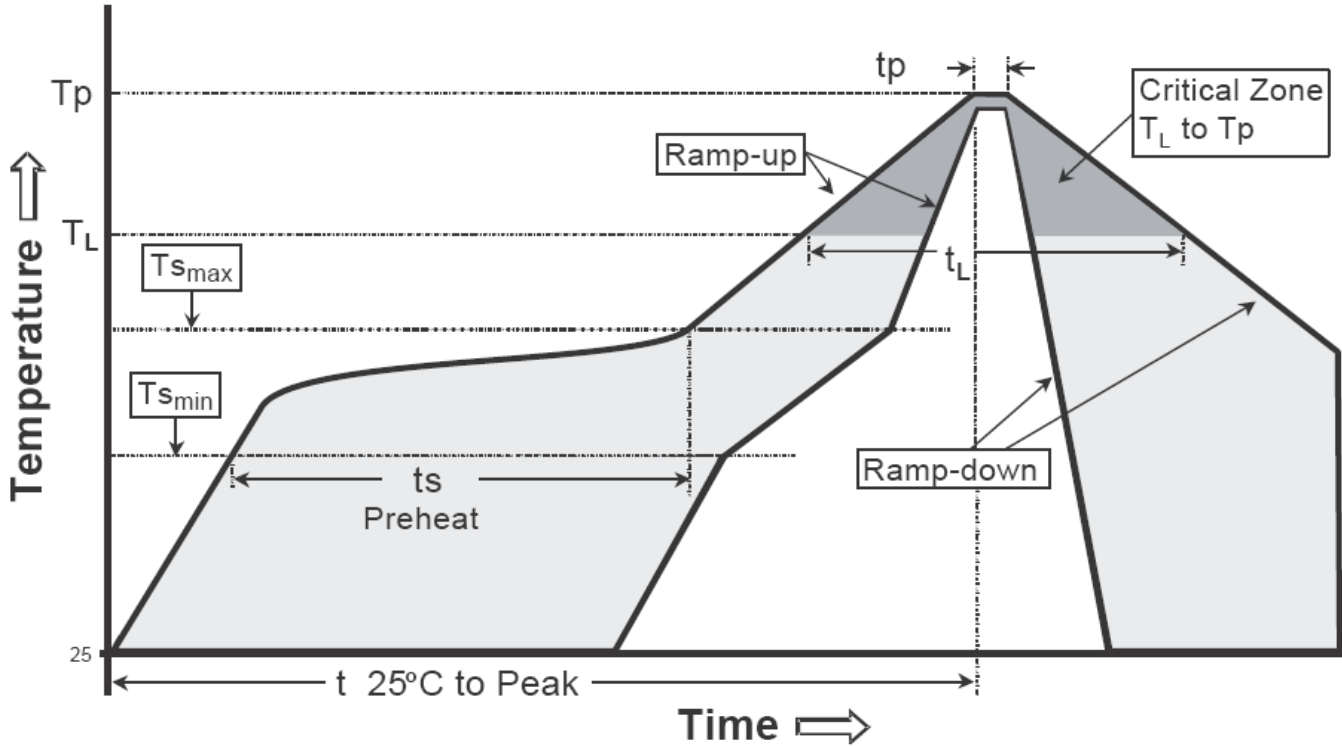

Profile feature	Sn-Pb eutectic Assembly	Pb-free Assembly
Average ramp-up rate (T _S max to T _P)	3°C/second max.	3°C/second max.
Preheat -Temperature Min (T _S min) -Temperature Max (T _S max) -Time (t _s min to t _s max)	100°C 150°C 60-120 seconds	150°C 200°C 60-180 seconds
Time maintained above: -Temperature (T _L) -Time (t _L)	183°C 60-150 seconds	217°C 60-150 seconds
Peak Temperature (T _P)	240 +0/-5 °C	260 +0/-5 °C
Time within 5°C of actual peak temperature (t _P)	10-30 seconds	20-40 seconds
Ramp down rate	6°C/second max.	6°C/second max.
Time 25 °C to peak temperature	6 minutes max.	8 minutes max.

Note:

- All temperatures refer to topside of the package, measured on the package body surface.