

N- Channel Enhancement Mode Power MOSFET

MTA500N03KN3

Features

- Low On Resistance
- Low Gate Charge
- Fast Switching Characteristic
- ESD protected gate, typical 4kV (HBM)

BV_{DSS}	30V
$I_D @ V_{GS}=4.5V, T_A=25^{\circ}C$	0.74A
$R_{DS(ON)}$ typ. @ $V_{GS}=4.5V, I_D=0.2A$	0.5Ω
$R_{DS(ON)}$ typ. @ $V_{GS}=2.5V, I_D=0.2A$	0.6Ω
$R_{DS(ON)}$ typ. @ $V_{GS}=1.8V, I_D=10mA$	0.9Ω

Equivalent Circuit

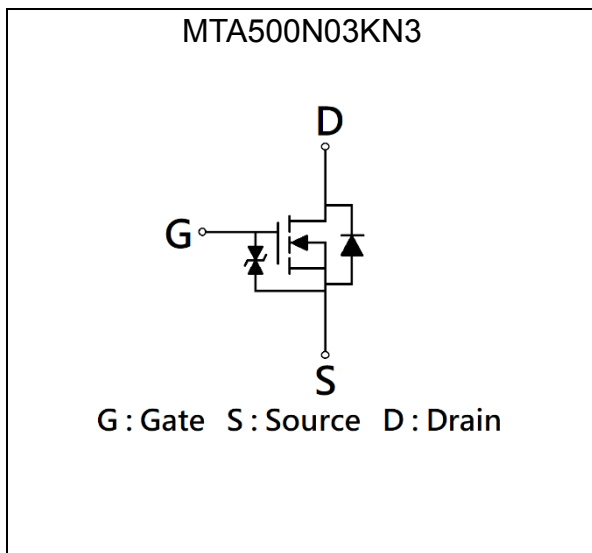

Outline

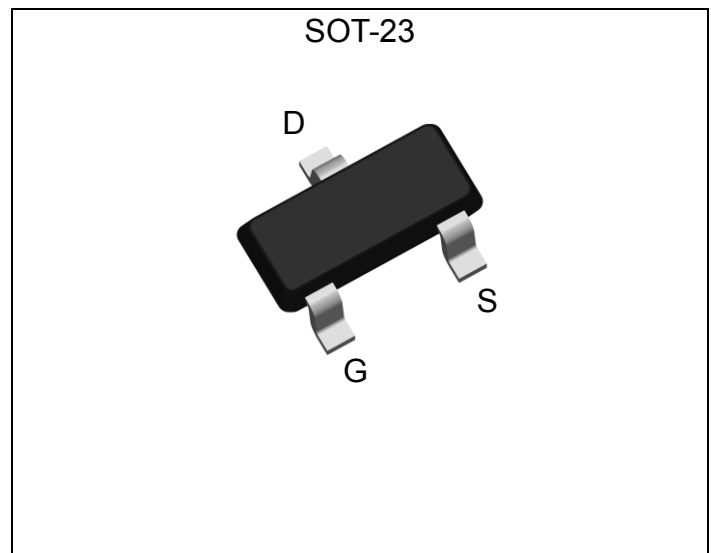

Ordering Information

Device	Package	Shipping
MTA500N03KN3-0-T1-G	SOT-23 (Pb-free lead plating and halogen-free package)	3000 pcs / Tape & Reel

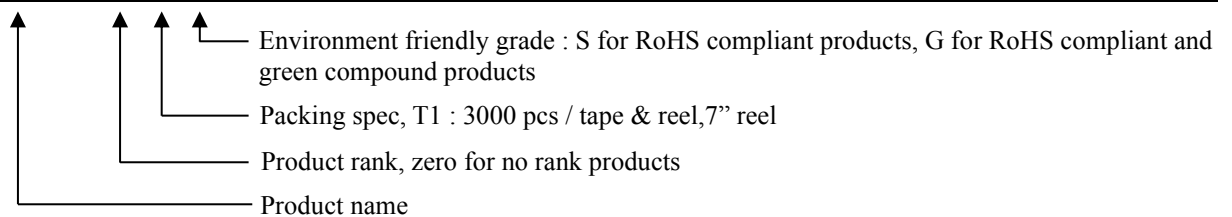



Absolute Maximum Ratings (TA=25°C)

Parameter	Symbol	Limits	Unit
Drain-Source Voltage	V _{DS}	30	V
Gate-Source Voltage	V _{GS}	±8	
Continuous Drain Current @ V _{GS} =4.5V, T _A =25°C	I _D	0.74	A
Continuous Drain Current @ V _{GS} =4.5V, T _A =70°C		0.59	
Pulsed Drain Current *a	I _{DM}	2.5	
Continuous Body Diode Forward Current @ T _A =25°C	I _S	0.6	
Pulsed Body Diode Forward Current @ T _A =25°C	I _{SM}	2.4	
ESD susceptibility *b	V _{ESD}	4000	V
Total Power Dissipation	P _D	T _A =25°C 0.7	W
		T _A =70°C 0.5	
Operating Junction and Storage Temperature Range	T _J , T _{stg}	-55~+150	°C

Thermal Data

Parameter	Symbol	Steady State	Unit
Thermal Resistance, Junction-to-ambient	R _{θJA}	180	°C/W

Note:

*a. Repetitive rating, pulse width limited by junction temperature T_J(MAX)=150°C. Ratings are based on low frequency and low duty cycles to keep initial T_J=25°C.

*b. Human body model, 1.5kΩ in series with 100pF.



Electrical Characteristics (T_A=25°C, unless otherwise specified)

Symbol	Min.	Typ.	Max.	Unit	Test Conditions
Static					
BV _{DSS}	30	-	-	V	V _{GS} =0V, I _D =250μA
V _{GS(th)}	0.4	-	1.2		V _{DS} =V _{GS} , I _D =250μA
G _{FS}	-	0.8	-	S	V _{DS} =5V, I _D =0.2A
I _{GSS}	-	-	±10	μA	V _{GS} =±8V, V _{DS} =0V
I _{DSS}	-	-	1		V _{DS} =24V, V _{GS} =0V
R _{DS(ON)}	-	0.5	0.7	Ω	V _{GS} =4.5V, I _D =0.2A
	-	0.6	0.9		V _{GS} =2.5V, I _D =0.2A
	-	0.9	2		V _{GS} =1.8V, I _D =10mA
Dynamic					
C _{iss}	-	31	-	pF	V _{DS} =15V, V _{GS} =0V, f=1MHz
C _{oss}	-	11	-		
C _{rss}	-	8	-		
Q _g *1, 2	-	0.9	-	nC	V _{DS} =20V, I _D =0.2A, V _{GS} =4.5V
Q _{gs} *1, 2	-	0.2	-		
Q _{gd} *1, 2	-	0.2	-		
t _{d(ON)} *1, 2	-	5.3	-	ns	V _{DS} =15V, I _D =0.2A, V _{GS} =4.5V, R _{GS} =6Ω
t _r *1, 2	-	16	-		
t _{d(OFF)} *1, 2	-	20	-		
t _f *1, 2	-	18	-		
Source-Drain Diode					
V _{SD} *1	-	0.85	1.2	V	I _S =0.2A, V _{GS} =0V
t _{rr}	-	4.7	-	ns	I _F =0.5A, dI _F /dt=100A/μs
Q _{rr}	-	1.2	-	nC	

Note:

*1. Pulse Test : Pulse Width ≤300μs, Duty Cycle≤2%

*2. Independent of operating temperature

Typical Characteristics

Typical Output Characteristics

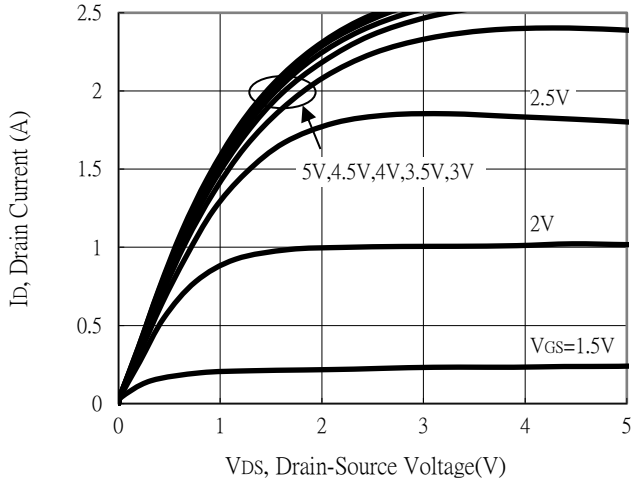

Breakdown Voltage vs Ambient Temperature

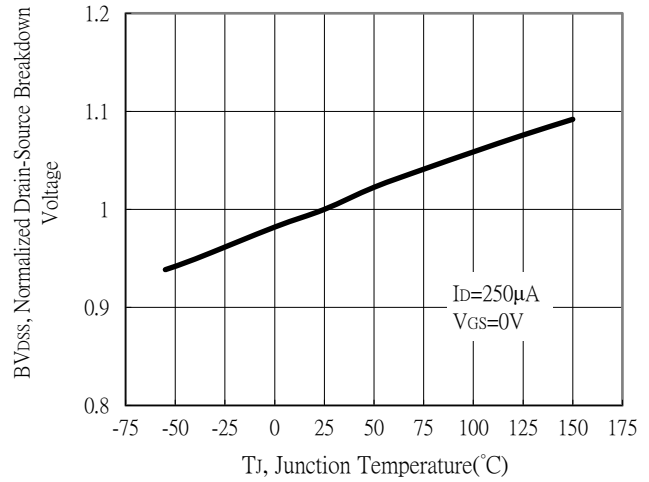

Static Drain-Source On-State resistance vs Drain Current

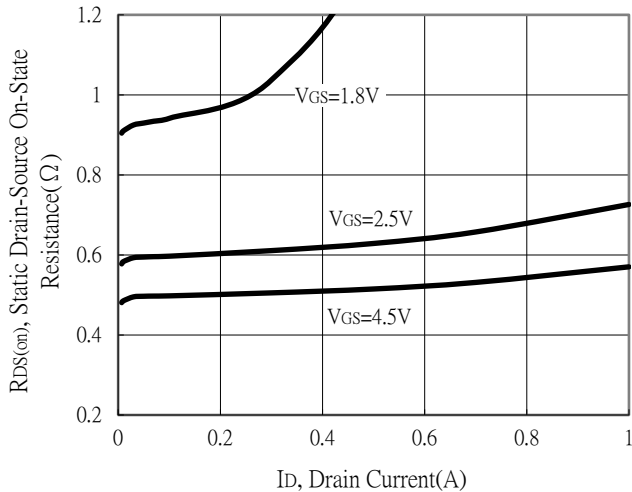

Body Diode Current vs Source-Drain Voltage

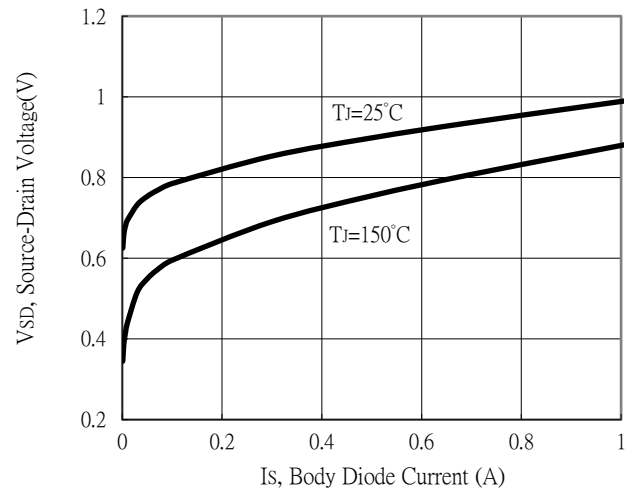

Static Drain-Source On-State Resistance vs Gate-Source Voltage

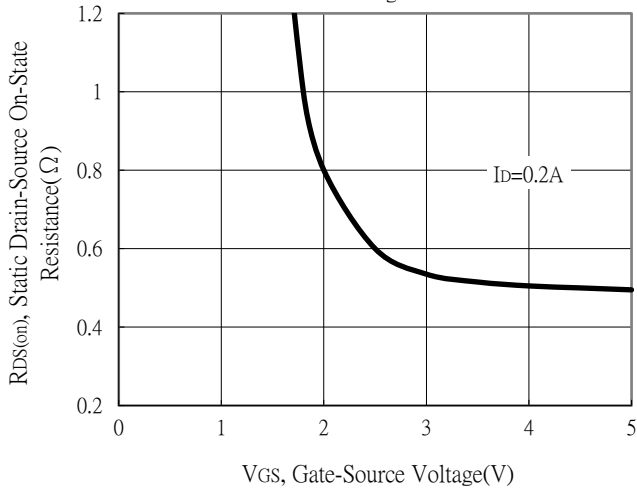

Drain-Source On-State Resistance vs Junction Temperature

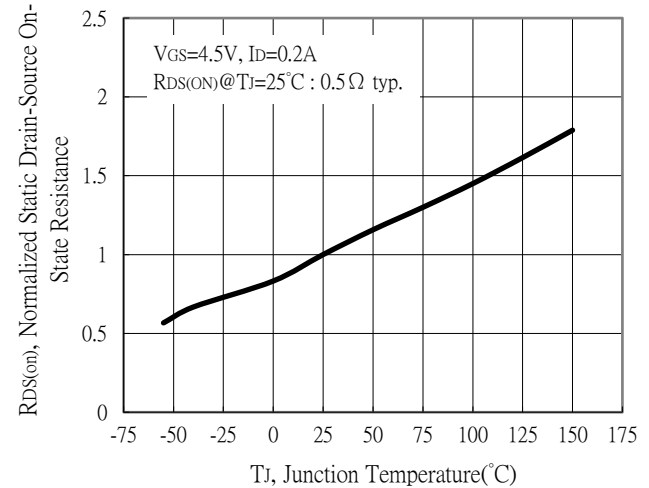

Typical Characteristics (Cont.)

Capacitance vs Drain-to-Source Voltage

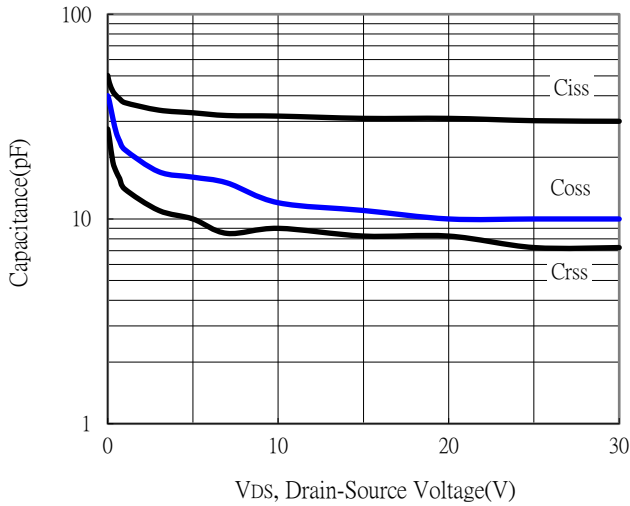

Threshold Voltage vs Junction Temperature

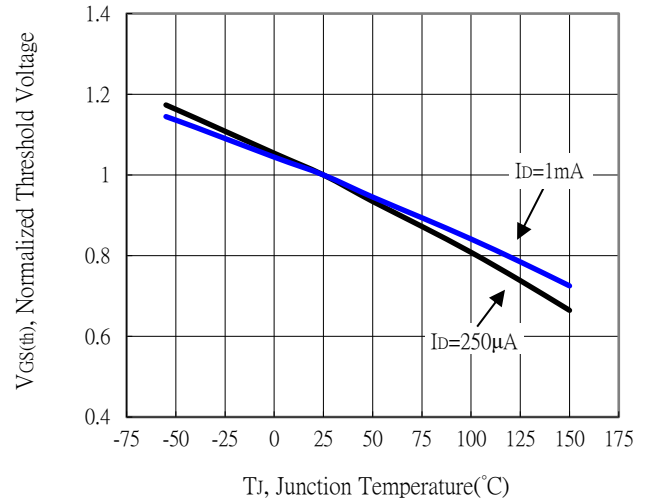

Forward Transfer Admittance vs Drain Current

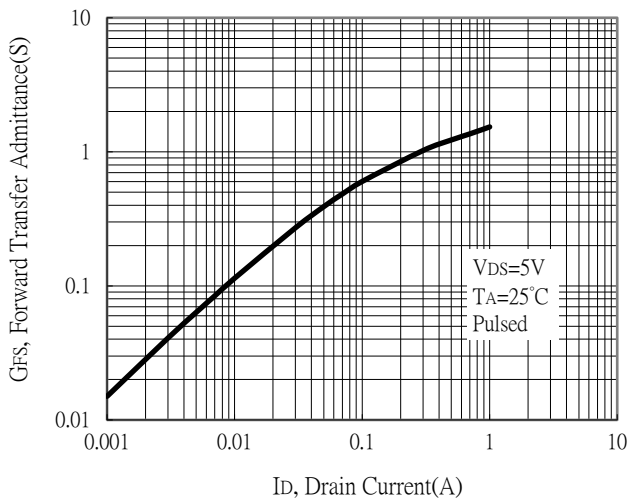

Gate Charge Characteristics

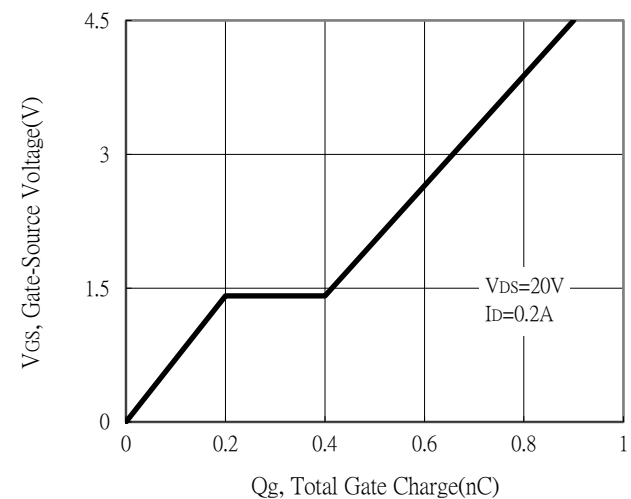

Maximum Safe Operating Area

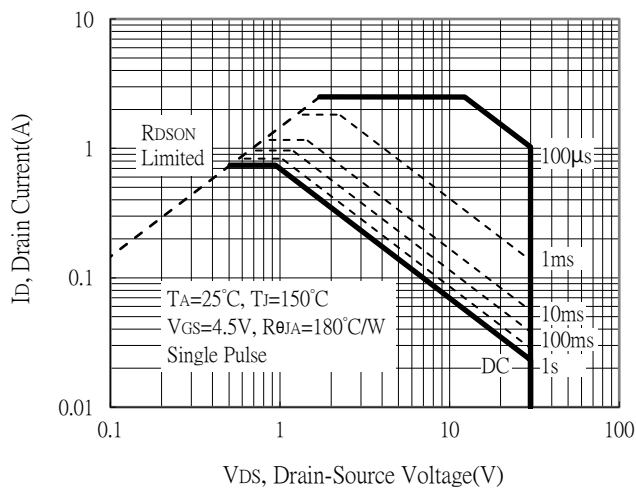

Maximum Drain Current vs Junction Temperature

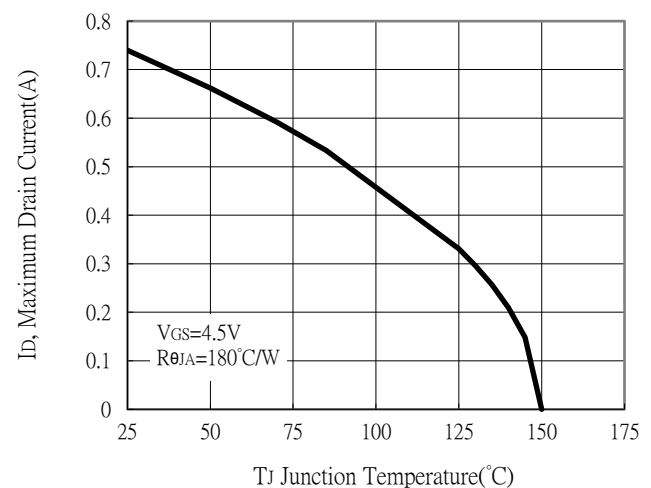

Typical Characteristics (Cont.)

Single Pulse Power Rating, Junction to Ambient

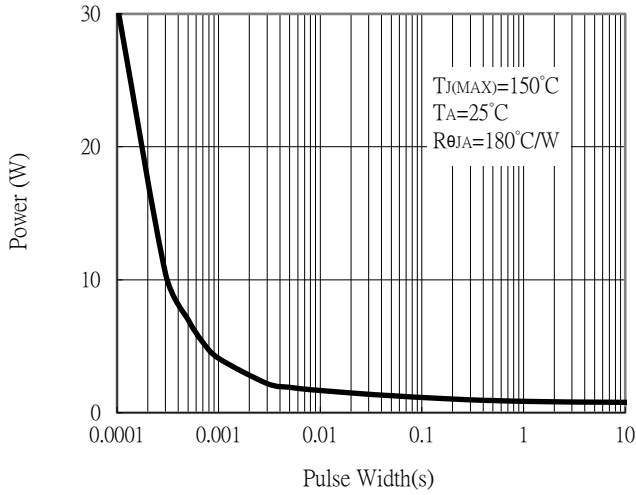

Transient Thermal Response Curves

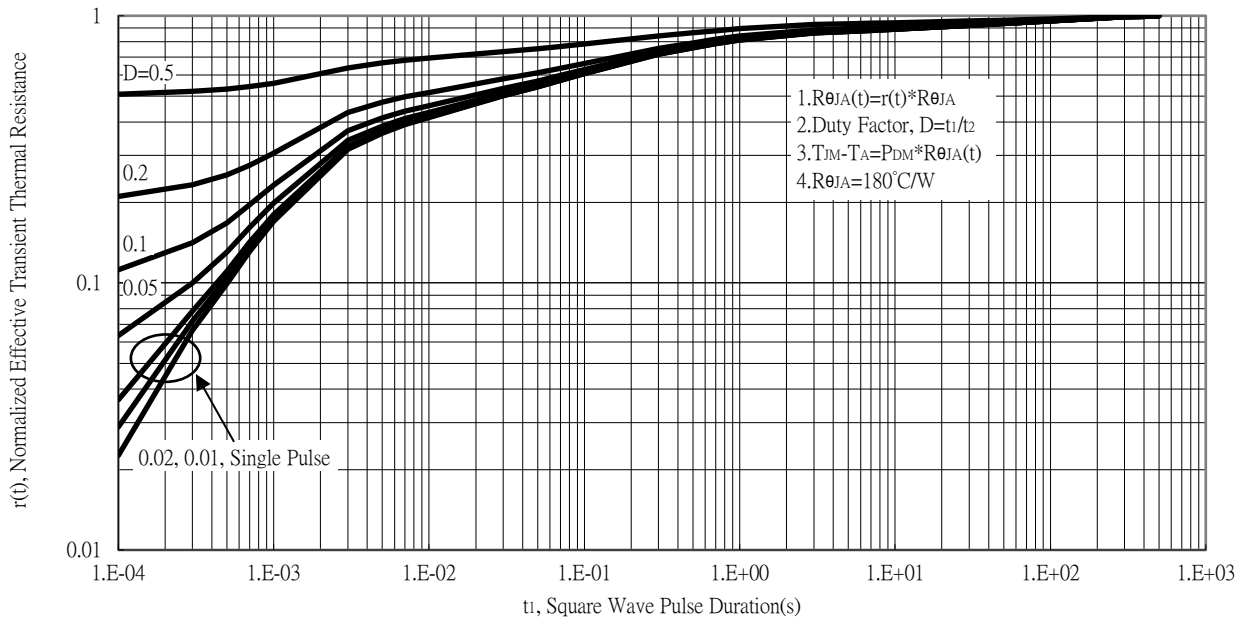

Recommended Soldering Footprint

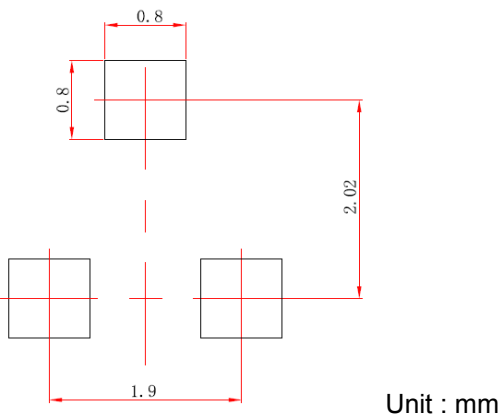

Reel Dimension

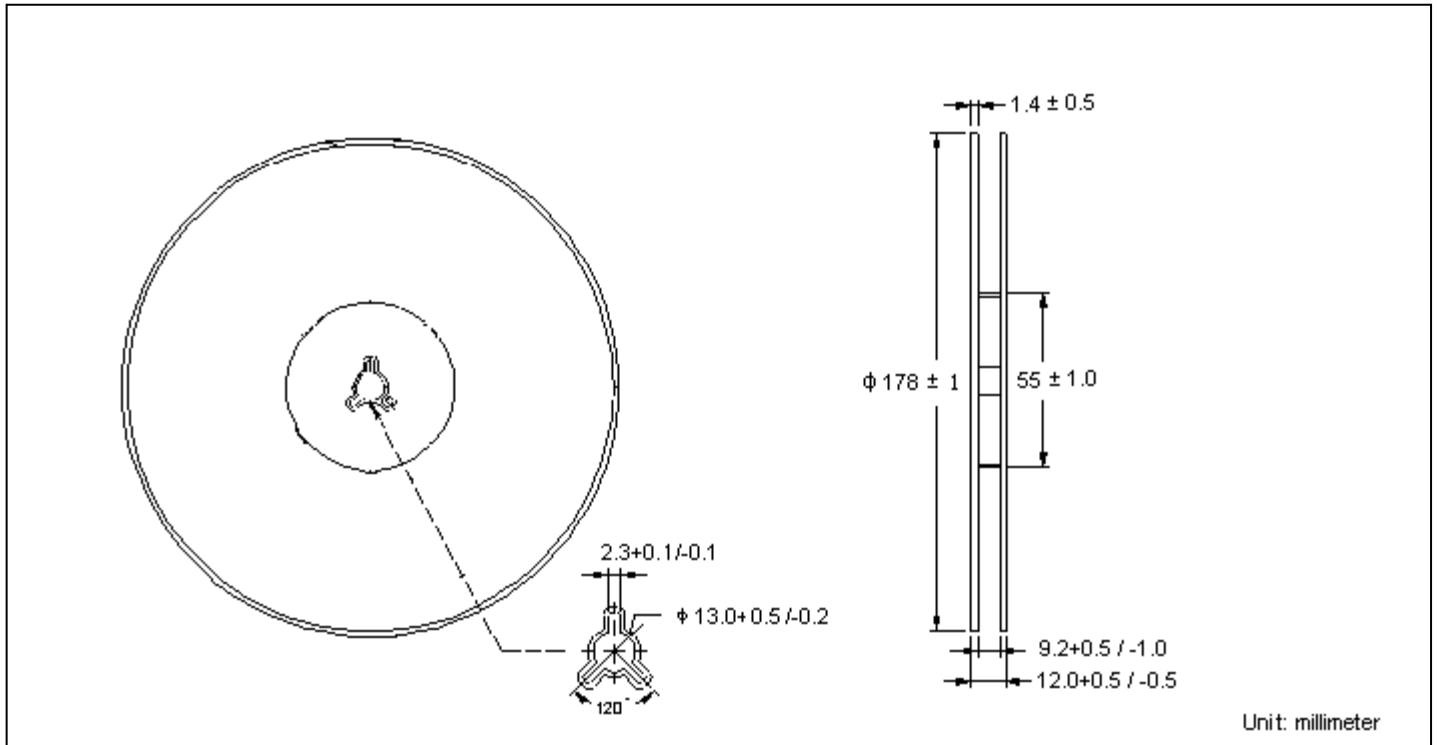

Carrier Tape Dimension

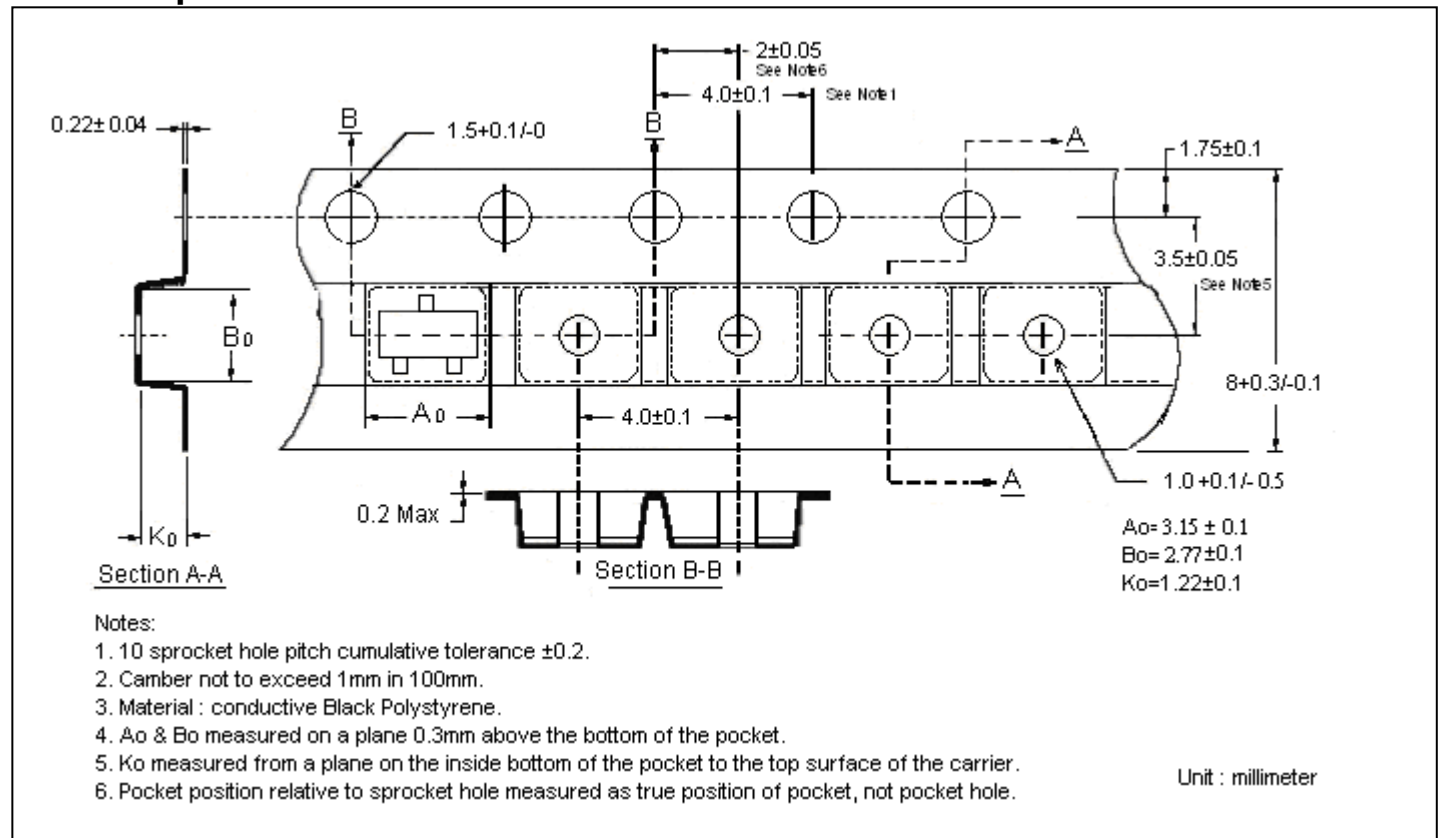

Recommended wave soldering condition

Product	Peak Temperature	Soldering Time
Pb-free devices	260 +0/-5 °C	5 +1/-1 seconds

Recommended temperature profile for IR reflow

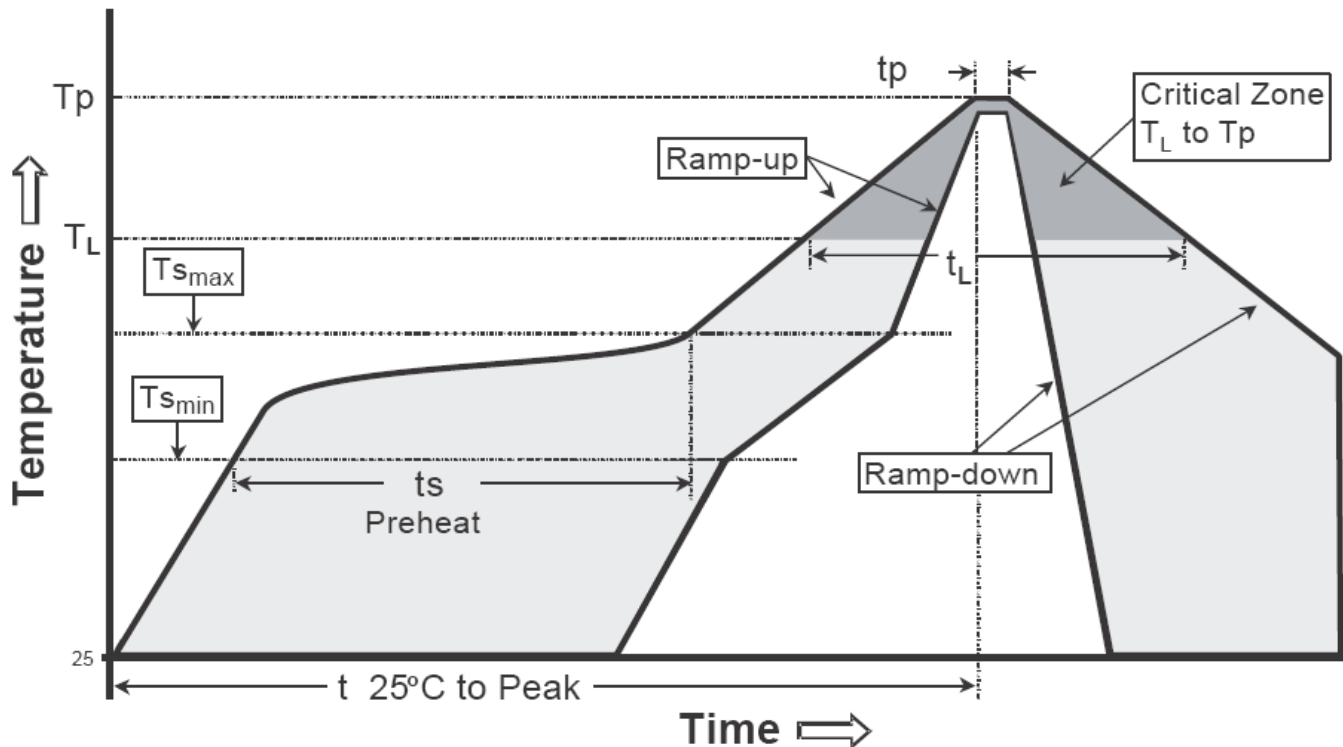

Profile feature	Sn-Pb eutectic Assembly	Pb-free Assembly
Average ramp-up rate (T _{smax} to T _p)	3°C/second max.	3°C/second max.
Preheat		
-Temperature Min(T _{s min})	100°C	150°C
-Temperature Max(T _{s max})	150°C	200°C
-Time(t _{s min} to t _{s max})	60-120 seconds	60-180 seconds
Time maintained above:		
-Temperature (T _L)	183°C	217°C
- Time (t _L)	60-150 seconds	60-150 seconds
Peak Temperature(T _P)	240 +0/-5 °C	260 +0/-5 °C
Time within 5°C of actual peak temperature(t _p)	10-30 seconds	20-40 seconds
Ramp down rate	6°C/second max.	6°C/second max.
Time 25 °C to peak temperature	6 minutes max.	8 minutes max.

Note : All temperatures refer to topside of the package, measured on the package body surface.

SOT-23 Dimension

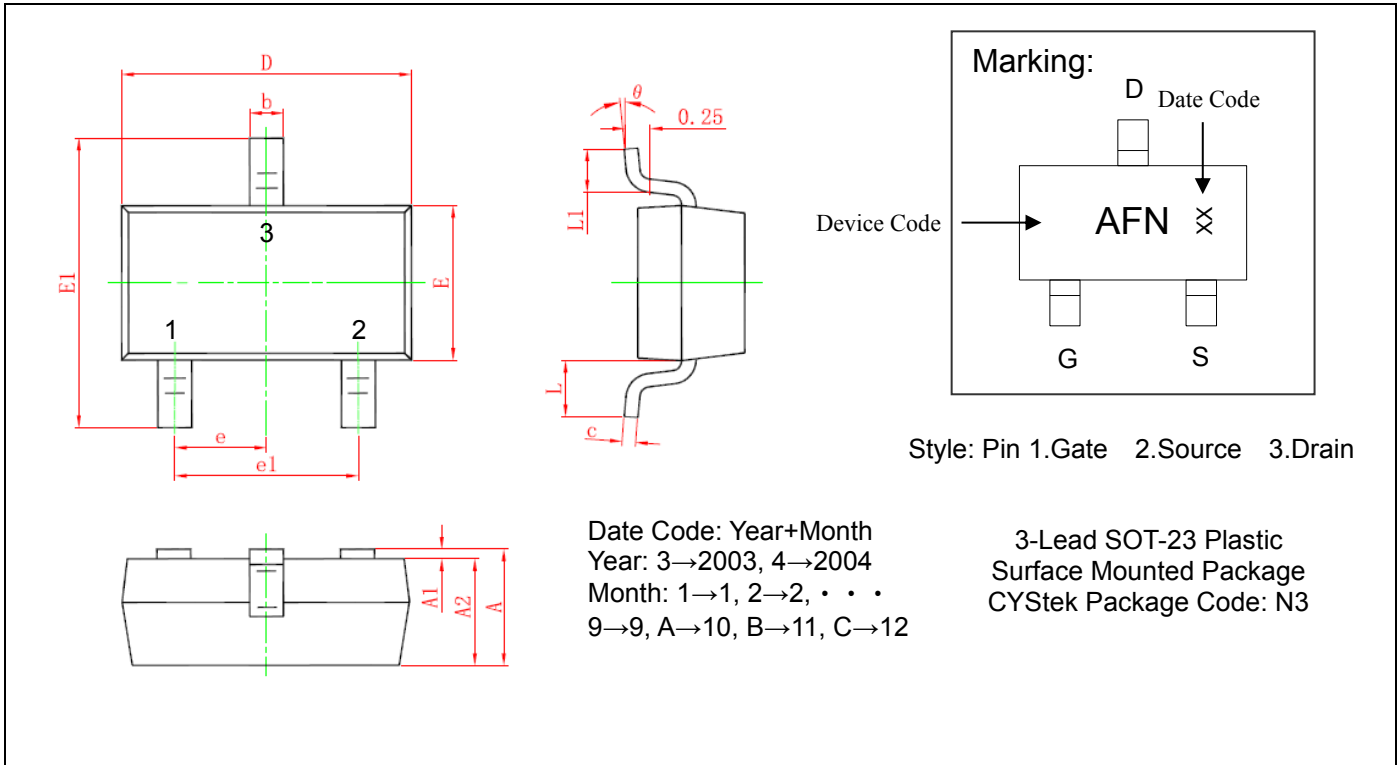

The diagram shows three views of the SOT-23 package: a top view with dimensions D, b, E1, E, e, and e1; a side view with dimensions L1, L, c, and a lead angle of 0.25 degrees; and a perspective view with dimensions A1, A2, and A. A marking diagram shows the layout with 'AFN' in the center, a date code 'D' at the top, and pins 'G' and 'S' at the bottom. A note identifies the pins: Pin 1 is Gate, Pin 2 is Source, and Pin 3 is Drain.

Marking:
 D Date Code
 Device Code → AFN ⊗
 G S

Style: Pin 1.Gate 2.Source 3.Drain

Date Code: Year+Month
 Year: 3→2003, 4→2004
 Month: 1→1, 2→2, . . .
 9→9, A→10, B→11, C→12

3-Lead SOT-23 Plastic
 Surface Mounted Package
 CYStek Package Code: N3

DIM	Inches		Millimeters		DIM	Inches		Millimeters	
	Min.	Max.	Min.	Max.		Min.	Max.	Min.	Max.
A	0.035	0.045	0.900	1.150	E1	0.089	0.100	2.250	2.550
A1	0.000	0.004	0.000	0.100	e	0.037 TYP		0.950 TYP	
A2	0.035	0.041	0.900	1.050	e1	0.071	0.079	1.800	2.000
b	0.012	0.020	0.300	0.500	L	0.022 REF		0.550 REF	
c	0.003	0.006	0.080	0.150	L1	0.012	0.020	0.300	0.500
D	0.110	0.118	2.800	3.000	θ	0°	8°	0°	8°
E	0.047	0.055	1.200	1.400					

Notes: 1.Controlling dimension: millimeters.
 2.Maximum lead thickness includes lead finish thickness, and minimum lead thickness is the minimum thickness of base material.
 3.If there is any question with packing specification or packing method, please contact your local CYStek sales office.

Material:

- Lead: Pure tin plated.
- Mold Compound: Epoxy resin family, flammability solid burning class: UL94V-0.

Important Notice:

- All rights are reserved. Reproduction in whole or in part is prohibited without the prior written approval of CYStek.
- CYStek reserves the right to make changes to its products without notice.
- CYStek **semiconductor products are not warranted to be suitable for use in Life-Support Applications, or systems.**
- CYStek assumes no liability for any consequence of customer product design, infringement of patents, or application assistance.