

# N-Channel Enhancement Mode MOSFET

# MTA500N03KC3

## Features

- Low On Resistance
- Low Gate Charge
- Fast Switching Characteristic
- ESD protected gate, typical 4kV (HBM)

$BV_{DSS}$	30V
$I_D @ V_{GS}=4.5V, T_A=25^\circ C$	1A
$R_{DS(ON) \text{ typ.}} @ V_{GS}=4.5V, I_D=0.2A$	$0.5 \Omega$
$R_{DS(ON) \text{ typ.}} @ V_{GS}=2.5V, I_D=0.2A$	$0.6 \Omega$
$R_{DS(ON) \text{ typ.}} @ V_{GS}=1.8V, I_D=10mA$	$0.9 \Omega$

## Equivalent Circuit

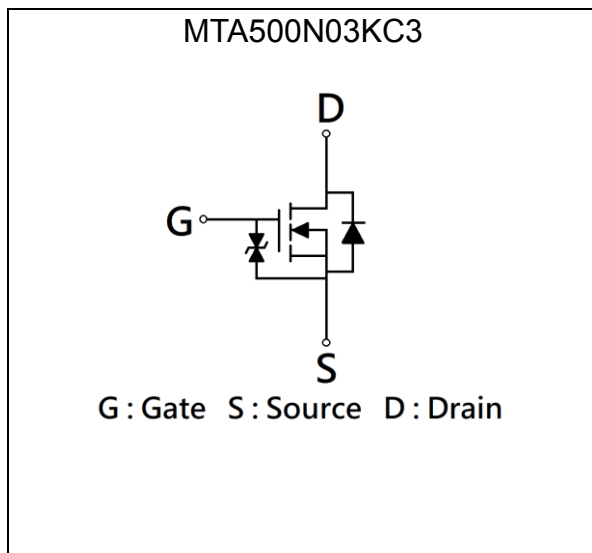

## Outline

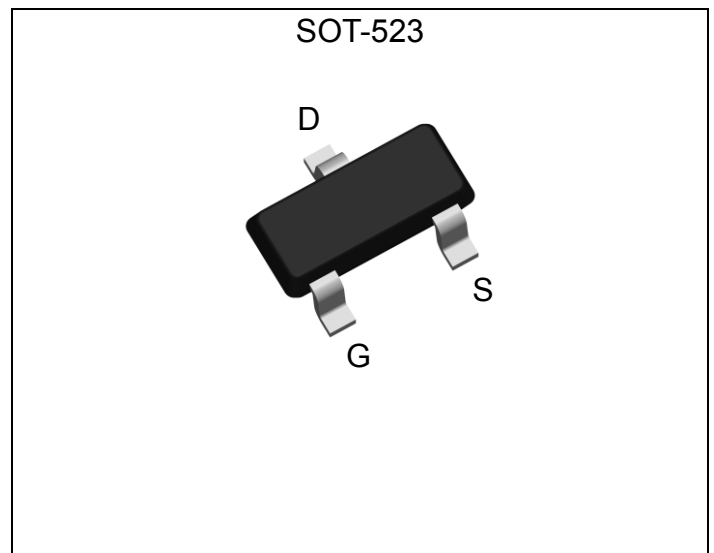

## Ordering Information

Device	Package	Shipping
MTA500N03KC3-0-T1-G	SOT-523 (Pb-free lead plating and halogen-free package)	3000 pcs / Tape & Reel

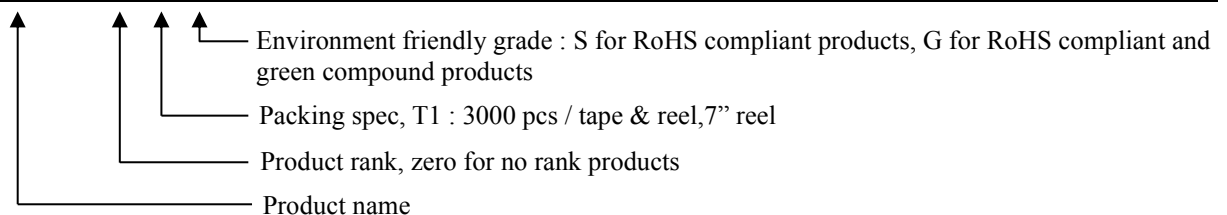

**Absolute Maximum Ratings (T<sub>A</sub>=25°C)**

Parameter	Symbol	Limits	Unit	
Drain-Source Voltage	V <sub>DS</sub>	30	V	
Gate-Source Voltage	V <sub>GS</sub>	±8		
Continuous Drain Current @ V <sub>GS</sub> =4.5V, T <sub>A</sub> =25°C	I <sub>D</sub>	1	A	
Continuous Drain Current @ V <sub>GS</sub> =4.5V, T <sub>A</sub> =70°C		0.8		
Pulsed Drain Current *a	I <sub>DM</sub>	2.5		
Continuous Body Diode Forward Current @ T <sub>A</sub> =25°C	I <sub>S</sub>	1		
ESD susceptibility *b	V <sub>ESD</sub>	4000	V	
Total Power Dissipation	P <sub>D</sub>	T <sub>A</sub> =25°C	1.3	W
		T <sub>A</sub> =70°C	0.8	
Operating Junction and Storage Temperature Range	T <sub>J</sub> , T <sub>stg</sub>	-55~+150	°C	

**Thermal Data**

Parameter	Symbol	Steady State	Unit
Thermal Resistance, Junction-to-ambient	R <sub>θJA</sub>	96	°C/W

Note:

\*a. Repetitive rating, pulse width limited by junction temperature T<sub>J(MAX)</sub>=150°C. Ratings are based on low frequency and low duty cycles to keep initial T<sub>J</sub>=25°C.

\*b. Human body model, 1.5kΩ in series with 100pF.



**Electrical Characteristics (T<sub>A</sub>=25°C, unless otherwise specified)**

Symbol	Min.	Typ.	Max.	Unit	Test Conditions
<b>Static</b>					
BV <sub>DSS</sub>	30	-	-	V	V <sub>GS</sub> =0V, I <sub>D</sub> =-250μA
V <sub>GS(th)</sub>	0.4	-	1.2		V <sub>DS</sub> =V <sub>GS</sub> , I <sub>D</sub> =-250μA
G <sub>FS</sub>	-	0.8	-	S	V <sub>DS</sub> =5V, I <sub>D</sub> =0.2A
I <sub>GSS</sub>	-	-	±10	μA	V <sub>GS</sub> =±8V, V <sub>DS</sub> =0V
I <sub>DSS</sub>	-	-	1		V <sub>DS</sub> =24V, V <sub>GS</sub> =0V
R <sub>DS(ON)</sub>	-	0.5	0.7	Ω	V <sub>GS</sub> =4.5V, I <sub>D</sub> =0.2A
	-	0.6	0.9		V <sub>GS</sub> =2.5V, I <sub>D</sub> =0.2A
	-	0.9	2		V <sub>GS</sub> =1.8V, I <sub>D</sub> =10mA
<b>Dynamic</b>					
C <sub>iss</sub>	-	31	-	pF	V <sub>DS</sub> =15V, V <sub>GS</sub> =0V, f=1MHz
C <sub>oss</sub>	-	11	-		
C <sub>rss</sub>	-	8	-		
Q <sub>g</sub> *1, 2	-	0.9	-	nC	V <sub>DS</sub> =20V, I <sub>D</sub> =0.2A, V <sub>GS</sub> =4.5V
Q <sub>gs</sub> *1, 2	-	0.2	-		
Q <sub>gd</sub> *1, 2	-	0.2	-		
t <sub>d(ON)</sub> *1, 2	-	5.3	-	ns	V <sub>DS</sub> =15V, I <sub>D</sub> =0.2A, V <sub>GS</sub> =4.5V, R <sub>GS</sub> =6Ω
t <sub>r</sub> *1, 2	-	16	-		
t <sub>d(OFF)</sub> *1, 2	-	20	-		
t <sub>f</sub> *1, 2	-	18	-		
<b>Source-Drain Diode</b>					
V <sub>SD</sub> *1	-	0.85	1.2	V	I <sub>S</sub> =0.2A, V <sub>GS</sub> =0V
t <sub>rr</sub>	-	4.7	-	ns	I <sub>F</sub> =0.5A, dI <sub>F</sub> /dt=100A/μs
Q <sub>rr</sub>	-	1.2	-	nC	

Note:

\*1. Pulse Test : Pulse Width ≤300μs, Duty Cycle≤2%

\*2. Independent of operating temperature



### Typical Characteristics

Typical Output Characteristics

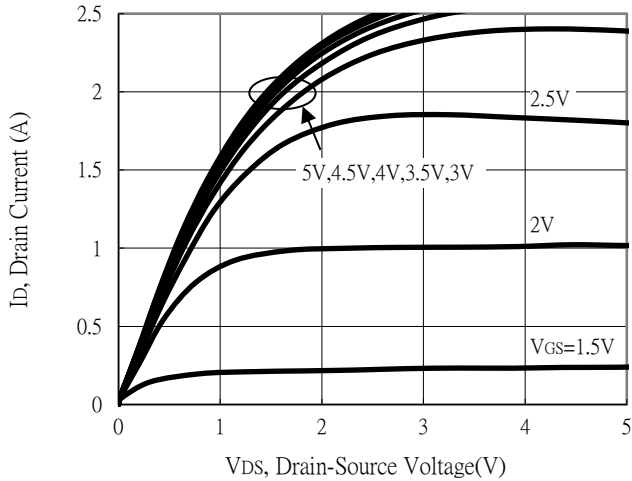

Breakdown Voltage vs Ambient Temperature

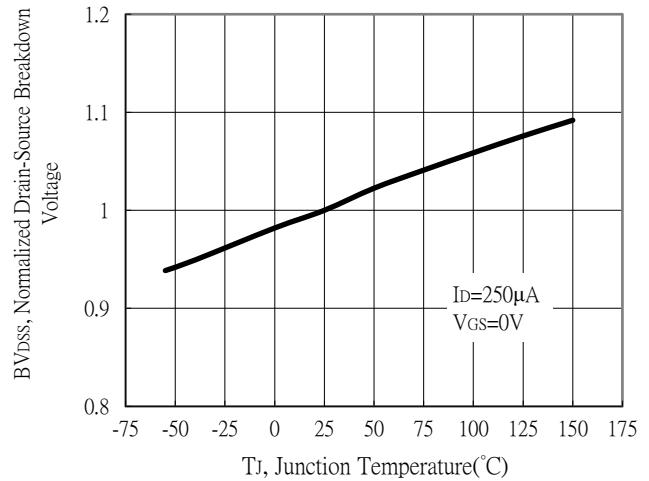

Static Drain-Source On-State resistance vs Drain Current

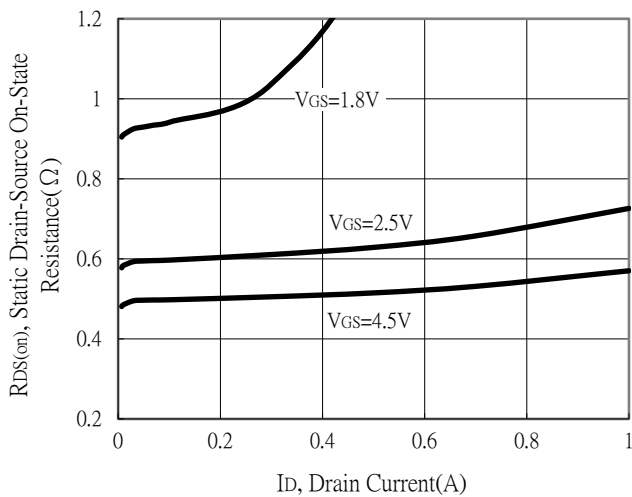

Body Diode Current vs Source-Drain Voltage

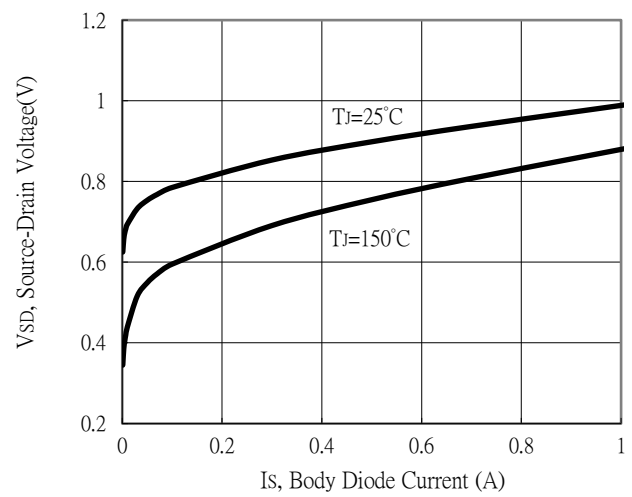

Static Drain-Source On-State Resistance vs Gate-Source Voltage

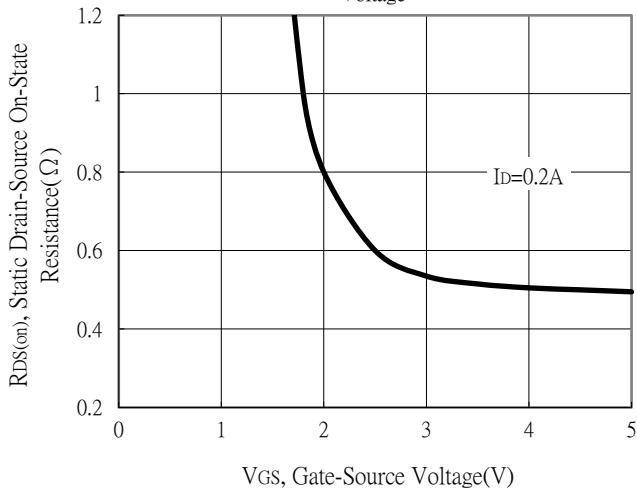

Drain-Source On-State Resistance vs Junction Temperature

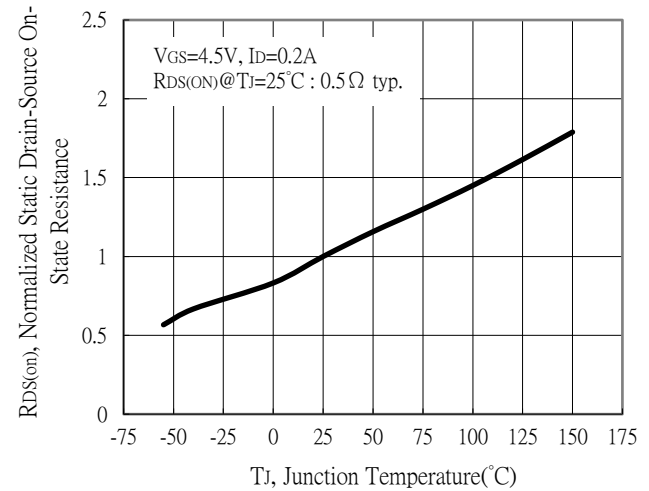



**Typical Characteristics (Cont.)**

Capacitance vs Drain-to-Source Voltage

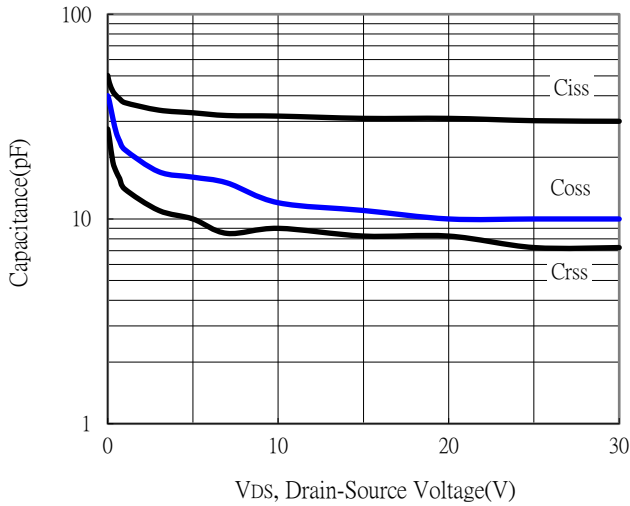

Threshold Voltage vs Junction Temperature

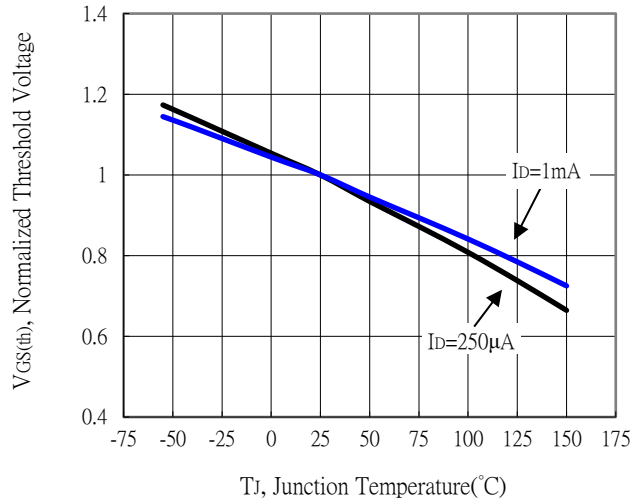

Forward Transfer Admittance vs Drain Current

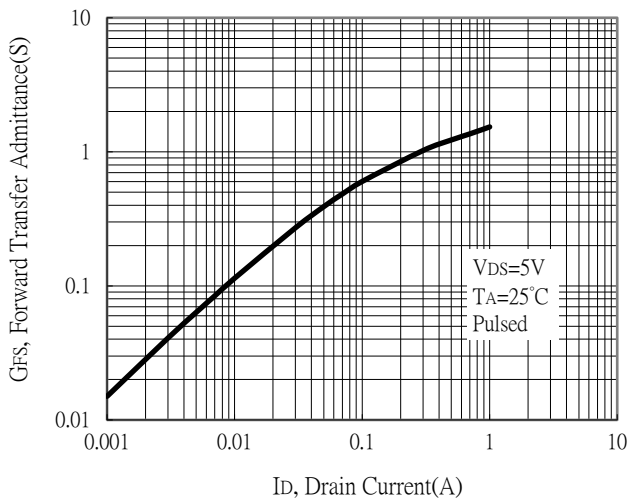

Gate Charge Characteristics

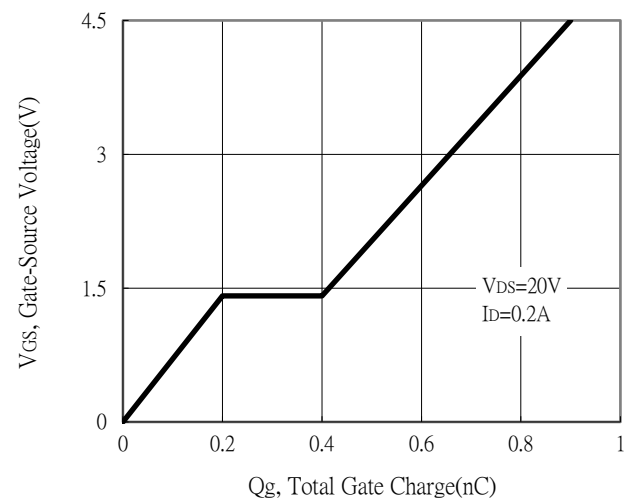

Maximum Safe Operating Area

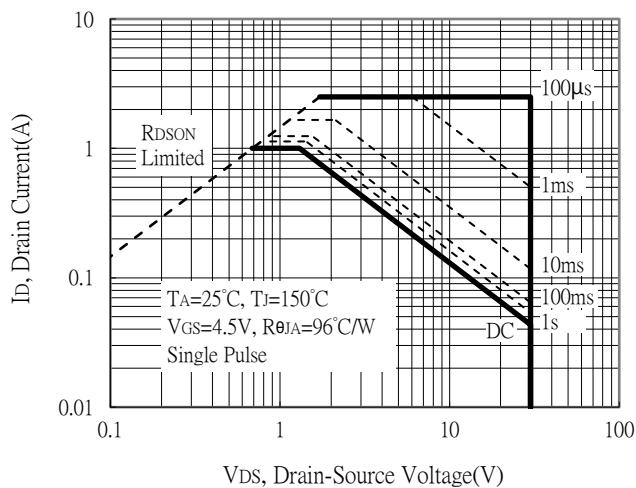

Maximum Drain Current vs Junction Temperature

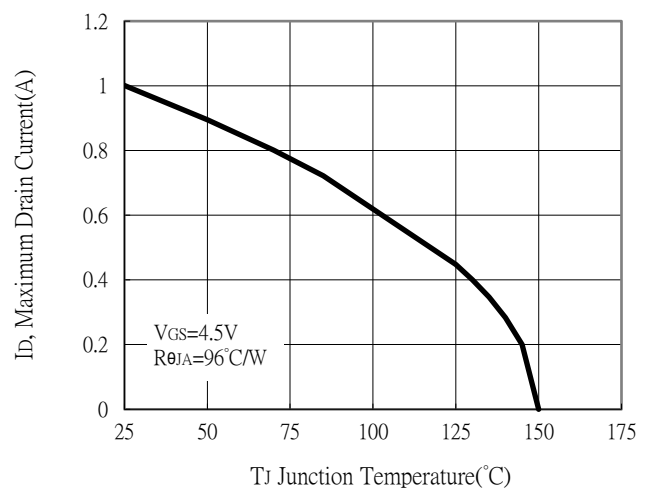

**Typical Characteristics (Cont.)**

Single Pulse Power Rating, Junction to Ambient

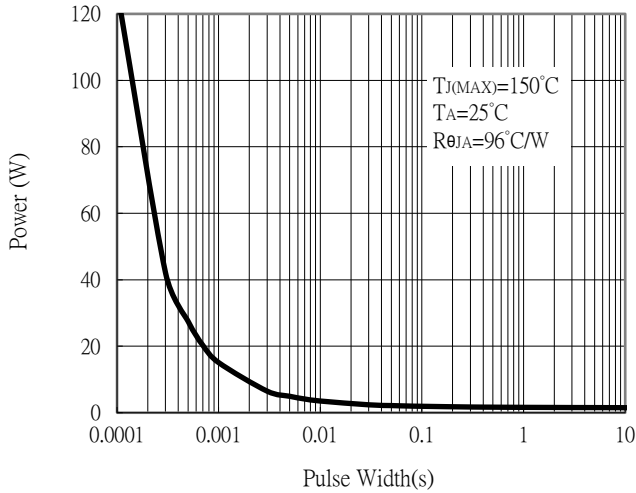

Transient Thermal Response Curves

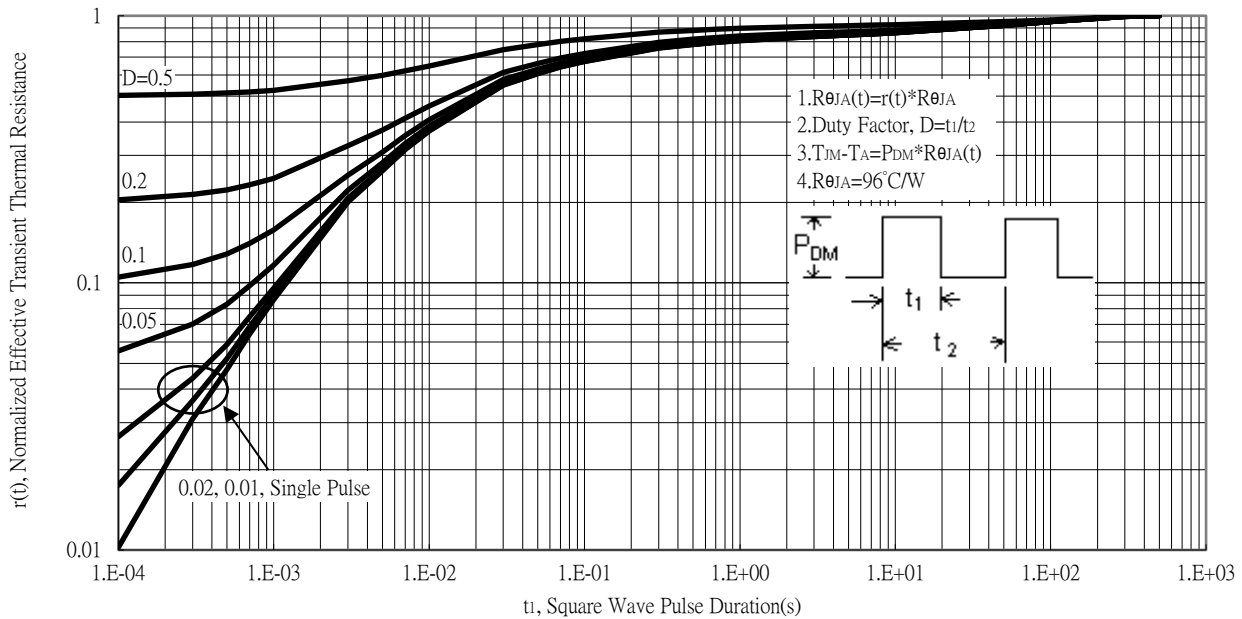

**Recommended Soldering Footprint**

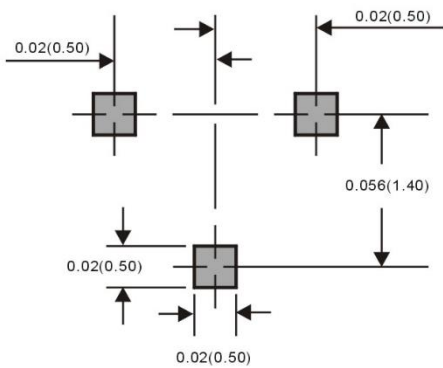

Dimensions in inches and (millimeters)

**Reel Dimension**

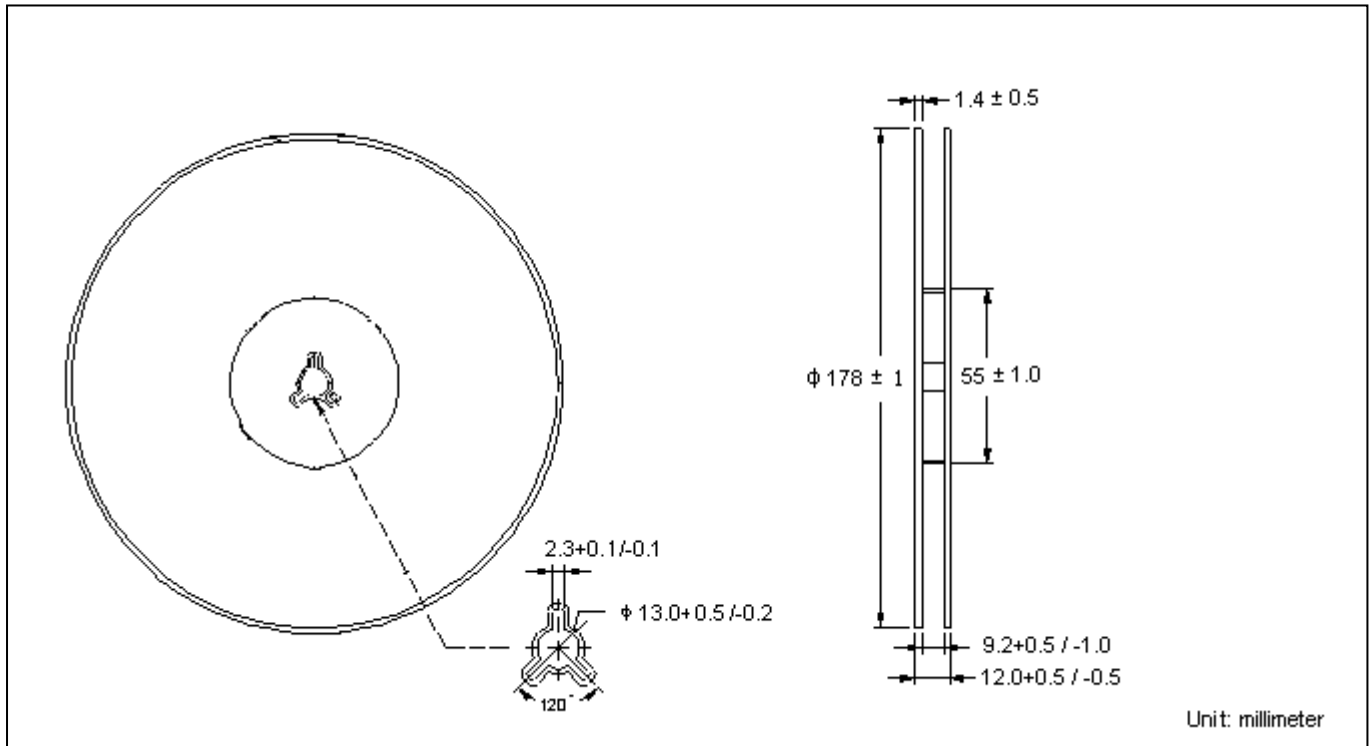

**Carrier Tape Dimension**

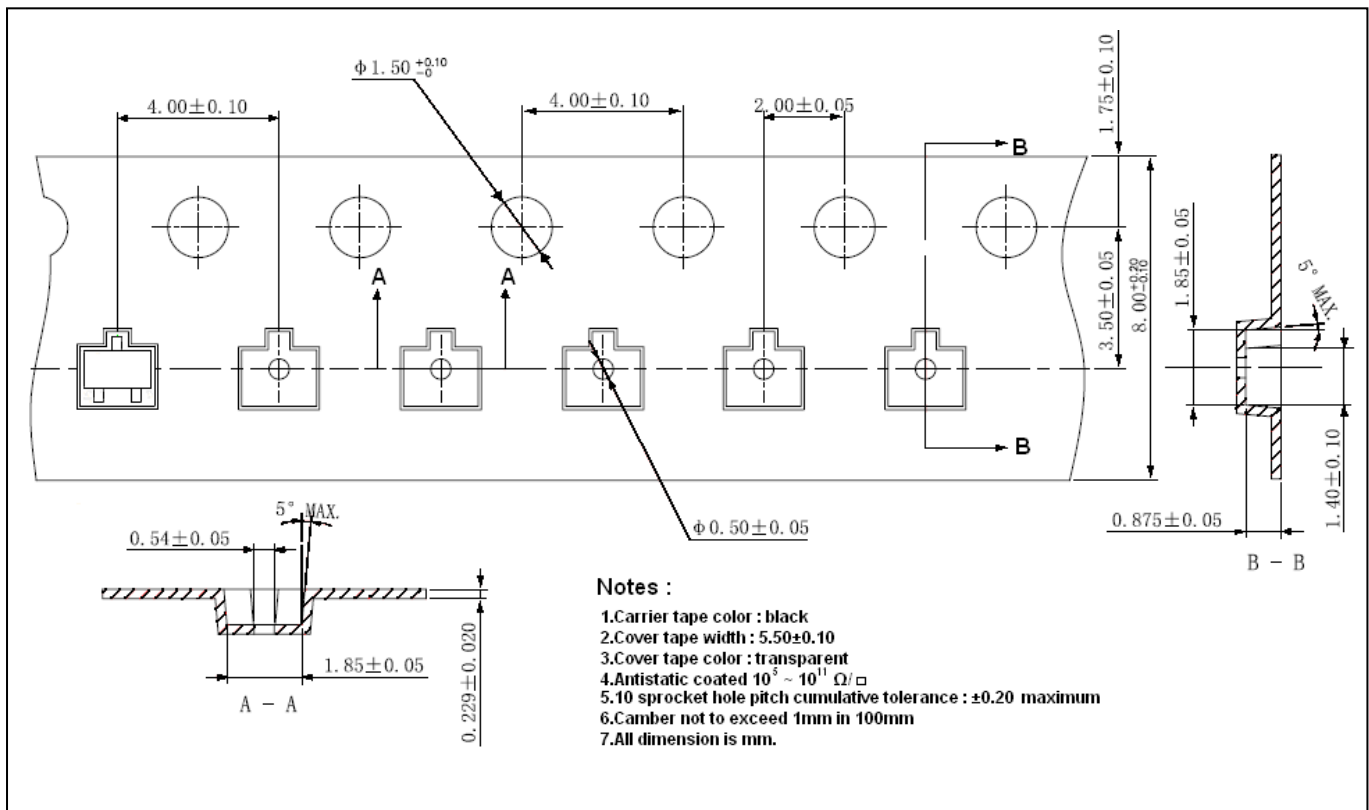

**Recommended wave soldering condition**

Product	Peak Temperature	Soldering Time
Pb-free devices	260 +0/-5 °C	5 +1/-1 seconds

**Recommended temperature profile for IR reflow**

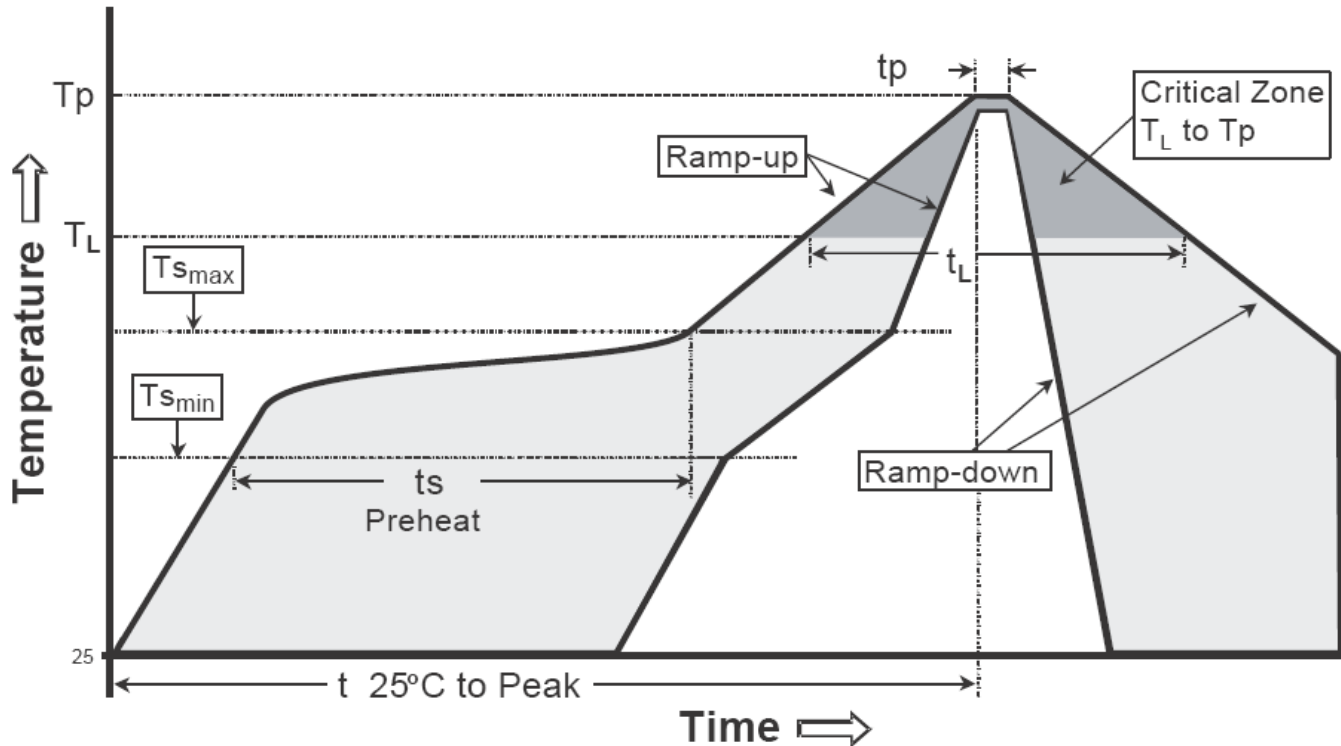

Profile feature	Sn-Pb eutectic Assembly	Pb-free Assembly
Average ramp-up rate (Tsmmax to Tp)	3°C/second max.	3°C/second max.
Preheat		
-Temperature Min(Ts min)	100°C	150°C
-Temperature Max(Ts max)	150°C	200°C
-Time(ts min to ts max)	60-120 seconds	60-180 seconds
Time maintained above:		
-Temperature (Tl)	183°C	217°C
- Time (tl)	60-150 seconds	60-150 seconds
Peak Temperature(Tp)	240 +0/-5 °C	260 +0/-5 °C
Time within 5°C of actual peak temperature(tp)	10-30 seconds	20-40 seconds
Ramp down rate	6°C/second max.	6°C/second max.
Time 25 °C to peak temperature	6 minutes max.	8 minutes max.

Note : All temperatures refer to topside of the package, measured on the package body surface.



**SOT-523 Dimension**

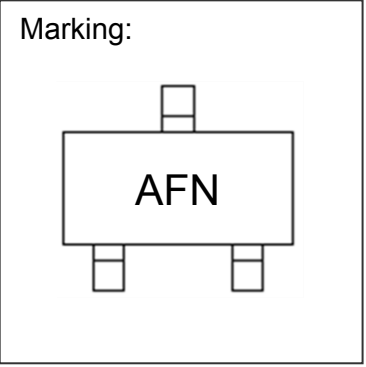
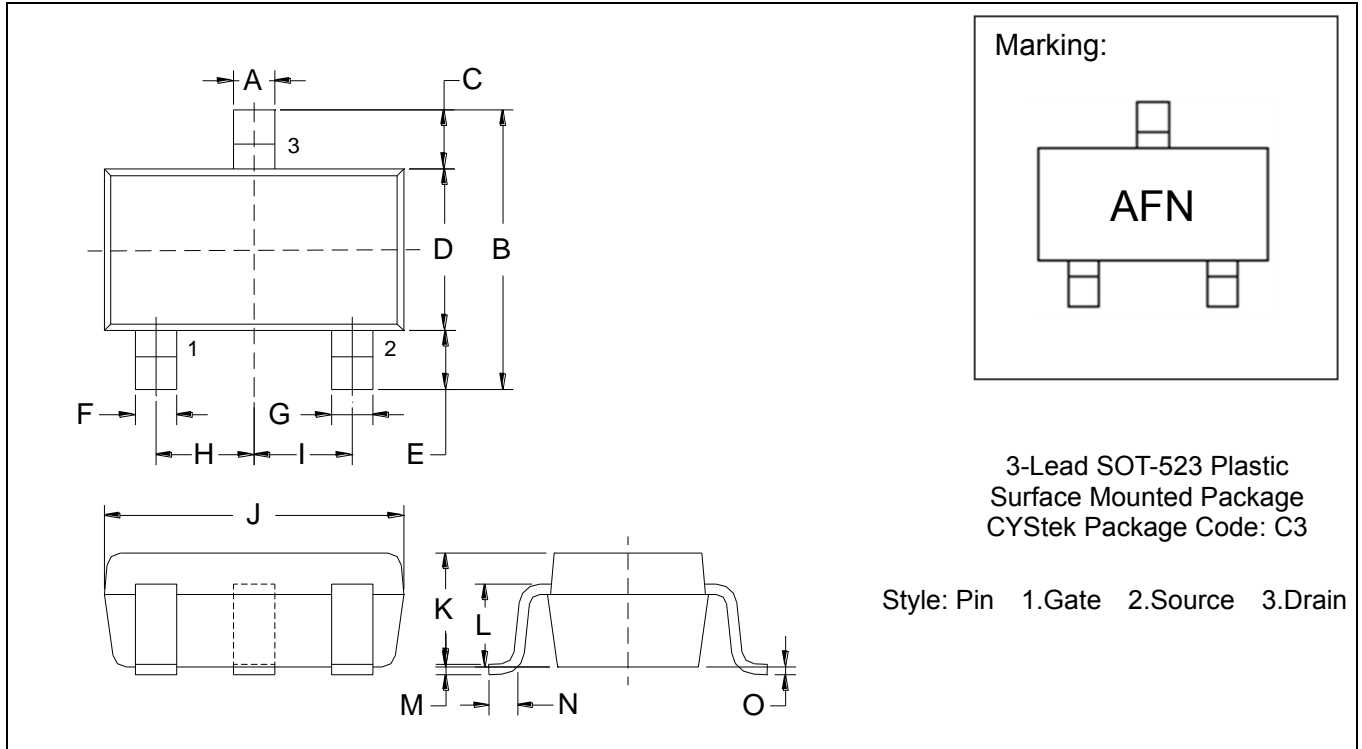

3-Lead SOT-523 Plastic  
 Surface Mounted Package  
 CYStek Package Code: C3

Style: Pin 1.Gate 2.Source 3.Drain

\*: Typical

DIM	Inches		Millimeters		DIM	Inches		Millimeters	
	Min.	Max.	Min.	Max.		Min.	Max.	Min.	Max.
A	0.0079	0.0157	0.20	0.40	I	*0.0197	-	*0.50	-
B	0.0591	0.0669	1.50	1.70	J	0.0610	0.0650	1.55	1.65
C	0.0118	0.0197	0.30	0.50	K	0.0276	0.0315	0.70	0.80
D	0.0295	0.0335	0.75	0.85	L	0.0224	0.0248	0.57	0.63
E	0.0118	0.0197	0.30	0.50	M	0.0020	0.0059	0.05	0.15
F	0.0039	0.0118	0.10	0.30	N	0.0039	0.0118	0.10	0.30
G	0.0039	0.0118	0.10	0.30	O	0	0.0031	0	0.08
H	*0.0197	-	*0.50	-					

Notes: 1.Controlling dimension: millimeters.  
 2.Maximum lead thickness includes lead finish thickness, and minimum lead thickness is the minimum thickness of base material.  
 3.If there is any question with packing specification or packing method, please contact your local CYStek sales office.

**Material:**

- Lead: Pure tin plated.
- Mold Compound: Epoxy resin family, flammability solid burning class: UL94V-0

**Important Notice:**

- All rights are reserved. Reproduction in whole or in part is prohibited without the prior written approval of CYStek.
- CYStek reserves the right to make changes to its products without notice.
- CYStek **semiconductor products are not warranted to be suitable for use in Life-Support Applications, or systems.**
- CYStek assumes no liability for any consequence of customer product design, infringement of patents, or application assistance.