

N-Channel Enhancement Mode Power MOSFET

MTA100N10KRV8

Features

- Simple Drive Requirement
- Low On-resistance
- Fast Switching Characteristic
- ESD protected gate
- Pb-free lead plating and halogen-free package

BV_{DSS}		100V
$I_D @ V_{GS}=10V, T_A=25^\circ C$		3A
$I_D @ V_{GS}=10V, T_C=25^\circ C$		8A
$R_{DS(on)(TYP)}$	$V_{GS}=10V, I_D=2.5A$	95mΩ
	$V_{GS}=4.5V, I_D=2.5A$	110mΩ
	$V_{GS}=3V, I_D=2.5A$	130mΩ

Equivalent Circuit

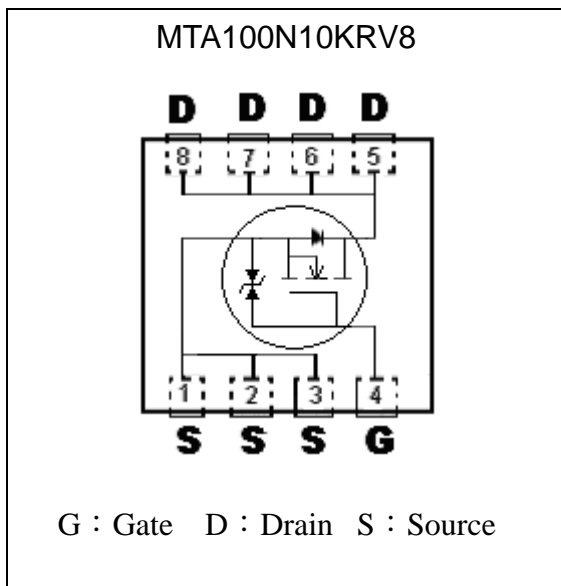

Outline

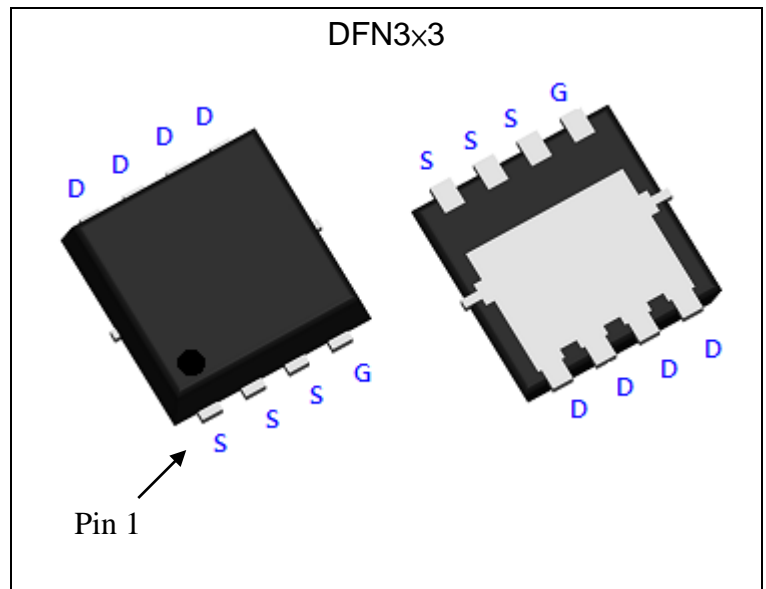

Ordering Information

Device	Package	Shipping
MTA100N10KRV8-0-T6-G	DFN3x3 (Pb-free lead plating and halogen-free package)	3000 pcs / tape & reel

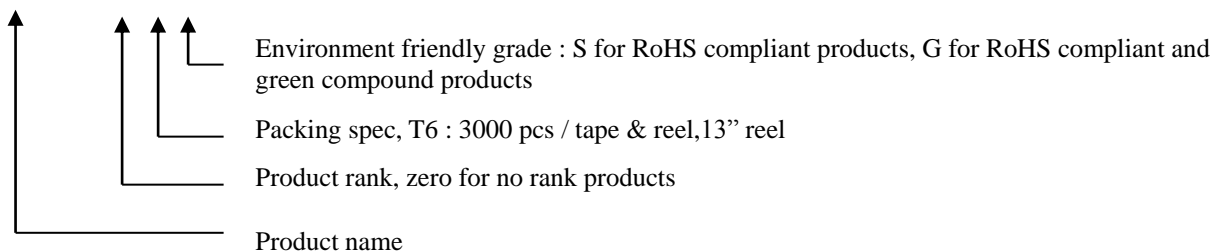



Absolute Maximum Ratings (Ta=25°C, unless otherwise specified)

Parameter	Symbol	Limits	Unit	
Drain-Source Voltage	V _{DS}	100	V	
Gate-Source Voltage	V _{GS}	±20		
Continuous Drain Current @ V _{GS} =10V, T _C =25°C	I _D	8	A	
Continuous Drain Current @ V _{GS} =10V, T _C =70°C		6.4		
Continuous Drain Current @ V _{GS} =10V, T _A =25°C		3		
Continuous Drain Current @ V _{GS} =10V, T _A =70°C		2.4		
Pulsed Drain Current	I _{DM}	18 *1		
Single Pulse Avalanche Current @ L=0.1mH	I _{AS}	10		
Avalanche Energy @ L=0.5mH, I _D =9A, V _{DD} =25V	E _{AS}	20 *3	mJ	
Repetitive Avalanche Energy @ L=0.05mH	E _{AR}	3		
Total Power Dissipation	P _D	T _C =25°C	15.6	W
		T _C =100°C	6.2	
	P _{DSM}	T _A =25°C	2.5 *2	
		T _A =70°C	1.6 *2	
Operating Junction and Storage Temperature Range	T _j , T _{stg}	-55~+150	°C	

Thermal Data

Parameter	Symbol	Value	Unit
Thermal Resistance, Junction-to-case, max	R _{θJC}	8	°C/W
Thermal Resistance, Junction-to-ambient, max	R _{θJA}	50 *2	

- Note : 1. Pulse width limited by maximum junction temperature.
 2. Surface mounted on a 1 in² pad of 2oz copper, t ≤ 5s. In practice R_{th,j-a} will be determined by customer's PCB characteristics. 125°C/W when mounted on a minimum pad of 2 oz. copper.
 3. 100% tested by conditions of L=0.5mH, I_{AS}=2A, V_{GS}=10V, V_{DD}=25V, rated 100V

Characteristics (Tc=25°C, unless otherwise specified)

Symbol	Min.	Typ.	Max.	Unit	Test Conditions
Static					
BV _{DSS}	100	-	-	V	V _{GS} =0V, I _D =250μA
V _{GS(th)}	0.5	-	1.7		V _{DS} = V _{GS} , I _D =250μA
G _{FS} *1	-	5.9	-	S	V _{DS} =10V, I _D =3A
I _{GSS}	-	-	±10	μA	V _{GS} =±16V, V _{DS} =0V
I _{DSS}	-	-	1		V _{DS} =80V, V _{GS} =0V
	-	-	10		V _{DS} =80V, V _{GS} =0V, T _j =85°C
R _{DS(ON)} *1	-	95	140	mΩ	V _{GS} =10V, I _D =2.5A
	-	110	165		V _{GS} =4.5V, I _D =2.5A
	-	130	310		V _{GS} =3V, I _D =2.5A

Dynamic					
Ciss	-	425	-	pF	V _{DS} =50V, V _{GS} =0V, f=1MHz
Coss	-	30	-		
Crss	-	17	-		
Qg(V _{GS} =10V) *1, 2	-	8	-	nC	V _{DS} =80V, V _{GS} =10V, I _D =2.5A
Qg(V _{GS} =4.5V) *1, 2	-	4.2	-		
Qgs *1, 2	-	1.2	-		
Qgd *1, 2	-	1.5	-		
t _{d(ON)} *1, 2	-	5	-	ns	V _{DS} =50V, I _D =2.5A, V _{GS} =10V, R _{GS} =1Ω
tr *1, 2	-	15.8	-		
t _{d(OFF)} *1, 2	-	22	-		
t _f *1, 2	-	5	-		
R _g	-	4.1	-	Ω	f=1MHz
Source-Drain Diode					
I _S *1	-	-	8	A	
I _{SM} *3	-	-	18		
V _{SD} *1	-	0.89	1.2	V	I _S =5A, V _{GS} =0V
trr	-	17.4	-	ns	I _F =2.5A, dI _F /dt=100A/μs
Q _{rr}	-	14.6	-	nC	

Note : *1.Pulse Test : Pulse Width ≤300μs, Duty Cycle≤2%
 *2.Independent of operating temperature
 *3.Pulse width limited by maximum junction temperature.

Recommended Soldering Footprint

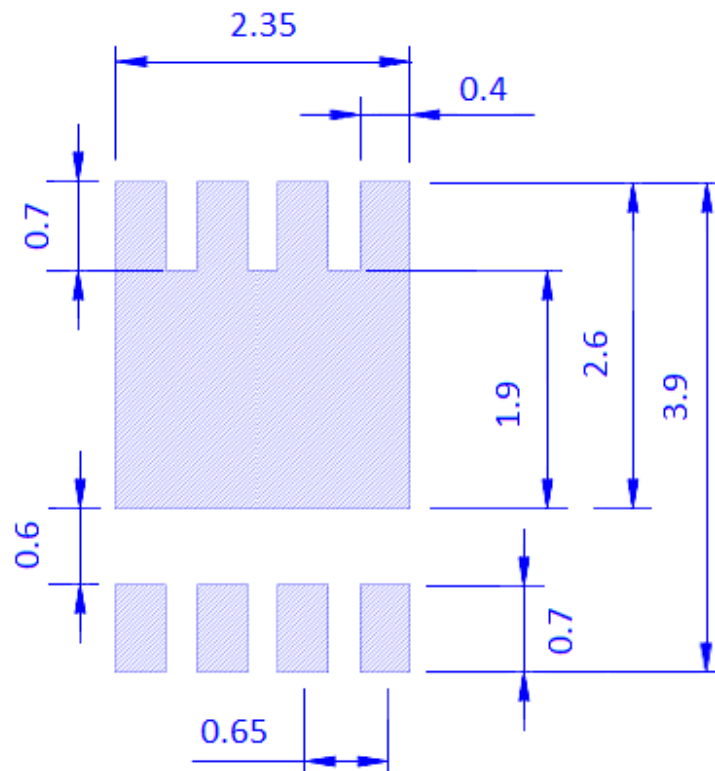

unit : mm



Typical Characteristics

Typical Output Characteristics

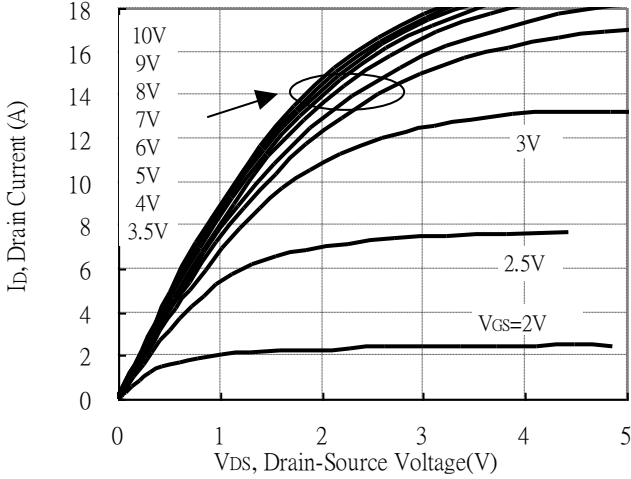

Brekdown Voltage vs Junction Temperature

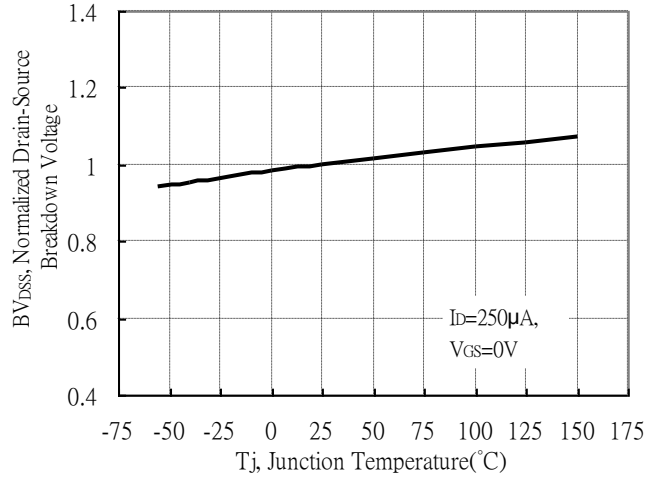

Static Drain-Source On-State resistance vs Drain Current

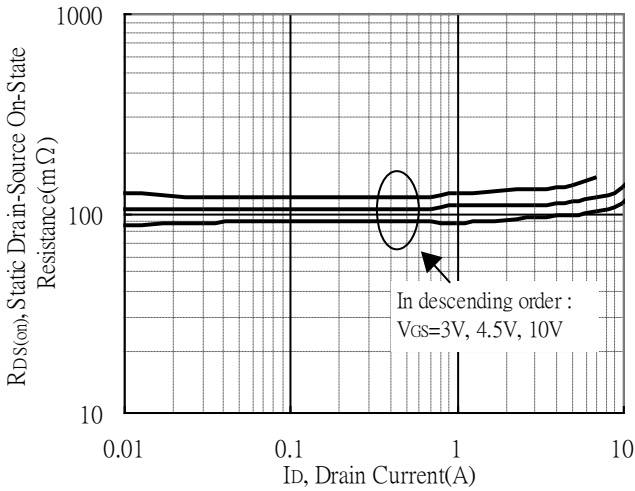

Reverse Drain Current vs Source-Drain Voltage

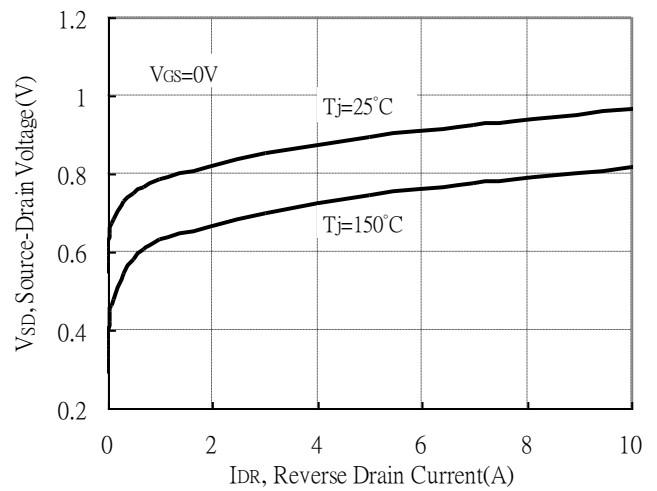

Static Drain-Source On-State Resistance vs Gate-Source Voltage

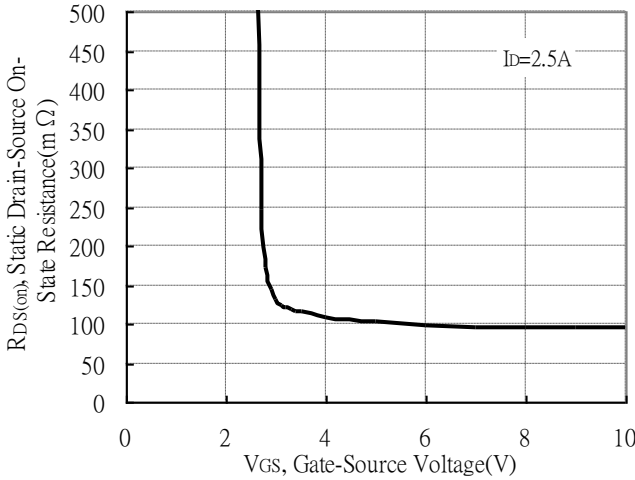

Drain-Source On-State Resistance vs Junction Temperature

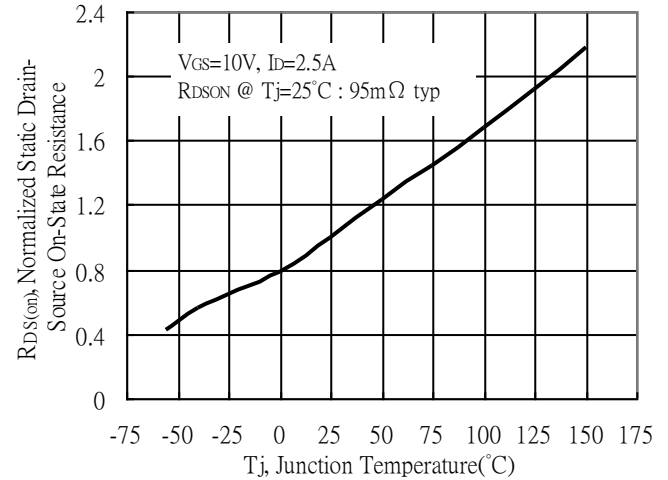

Typical Characteristics(Cont.)

Capacitance vs Drain-to-Source Voltage

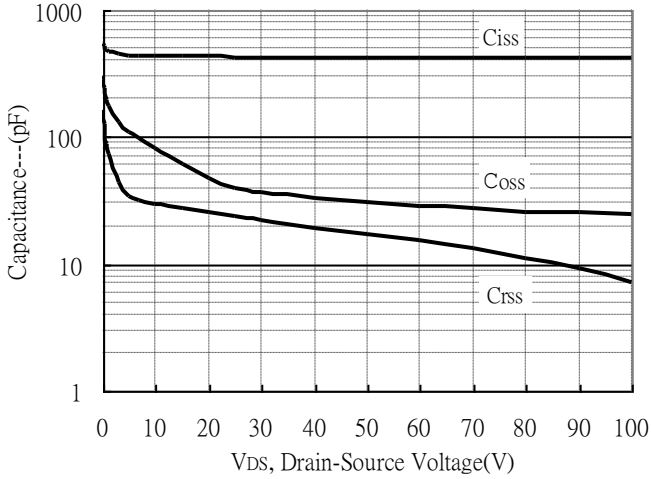

Threshold Voltage vs Junction Temperature

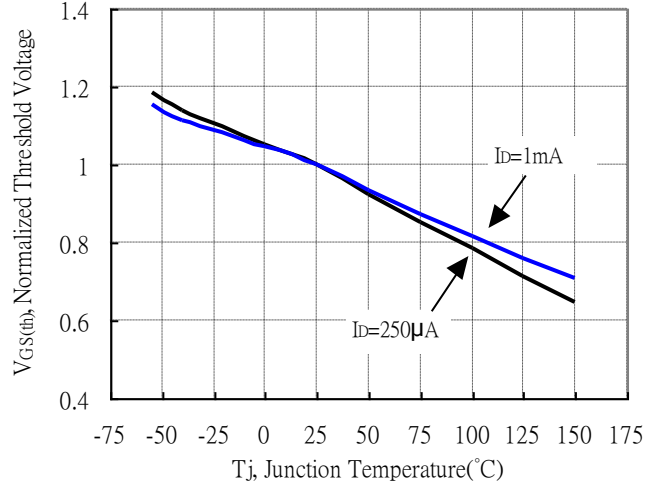

Forward Transfer Admittance vs Drain Current

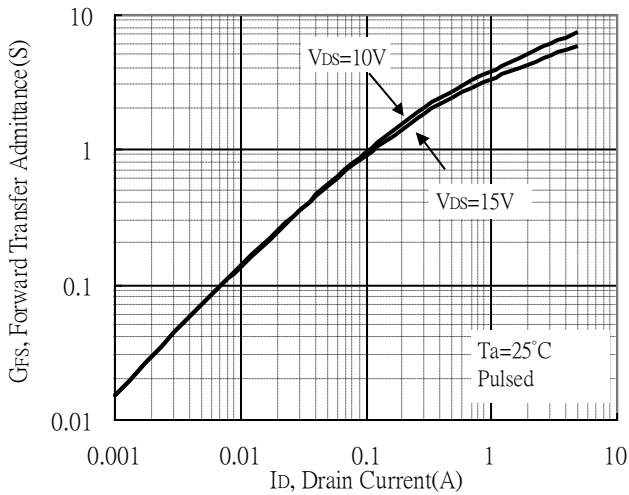

Gate Charge Characteristics

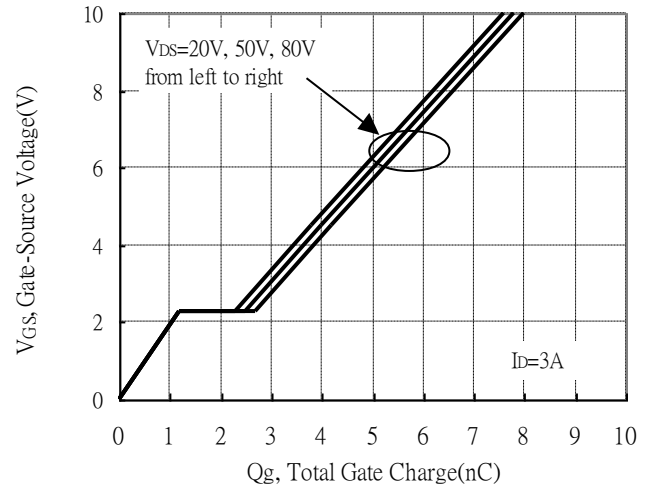

Maximum Safe Operating Area

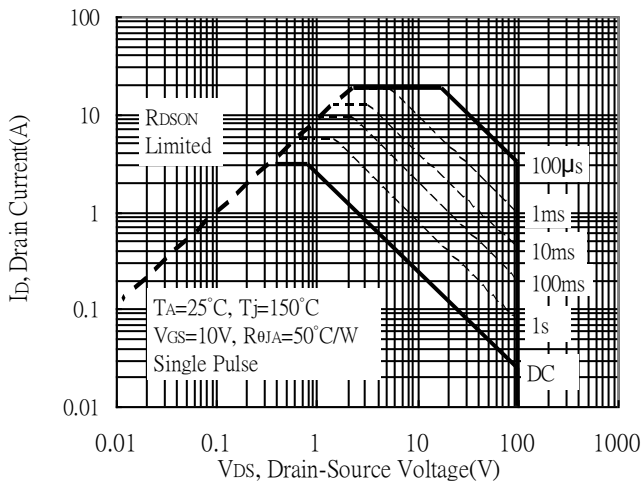

Maximum Drain Current vs Junction Temperature

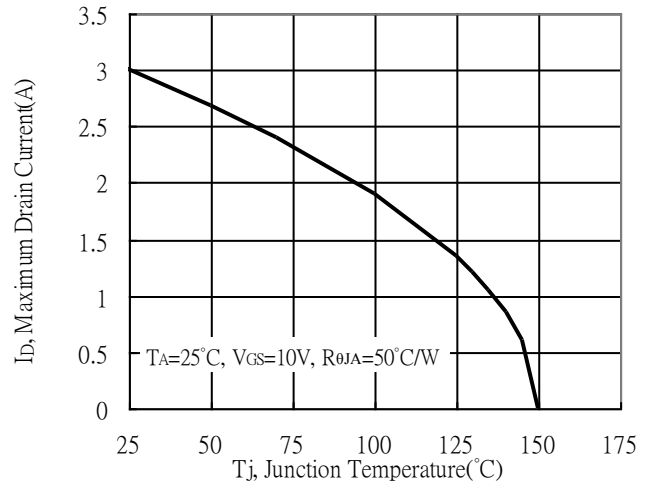

Typical Characteristics(Cont.)

Maximum Safe Operating Area

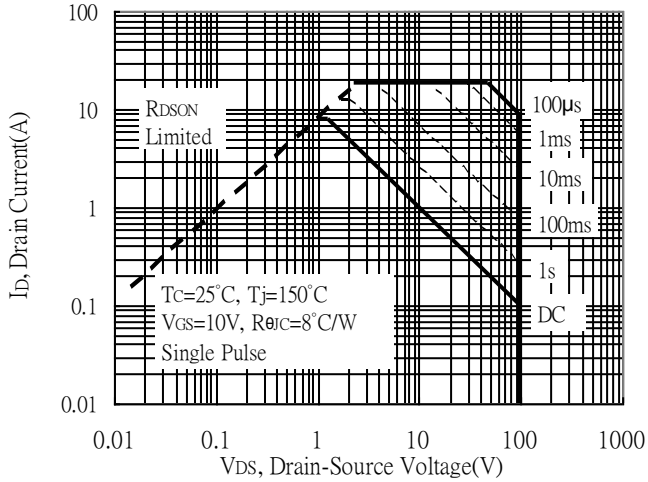

Maximum Drain Current vs Case Temperature

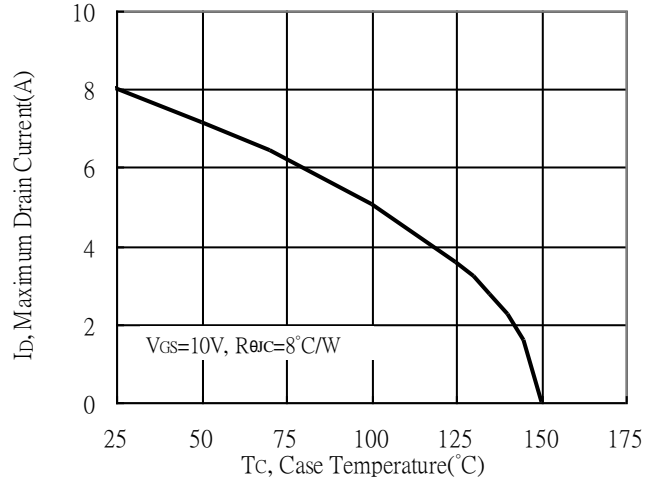

Typical Transfer Characteristics

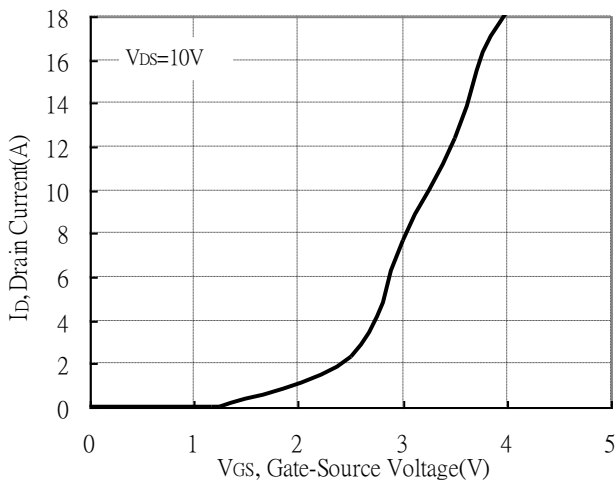

Single Pulse Power Rating, Junction to Ambient
(Note on page 2)

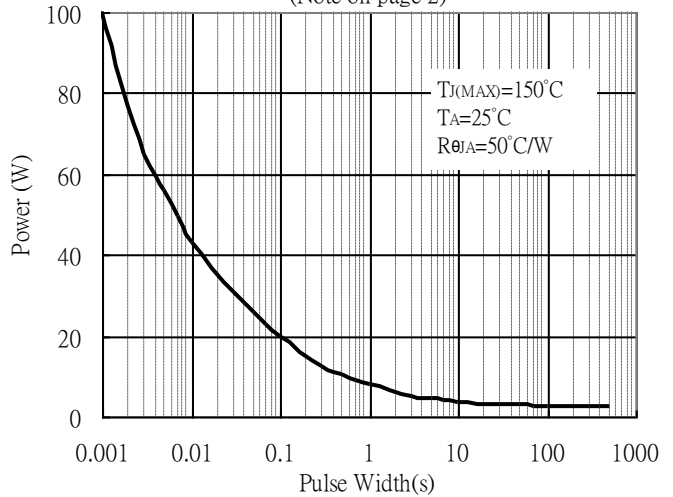

Single Pulse Power Rating, Junction to Case

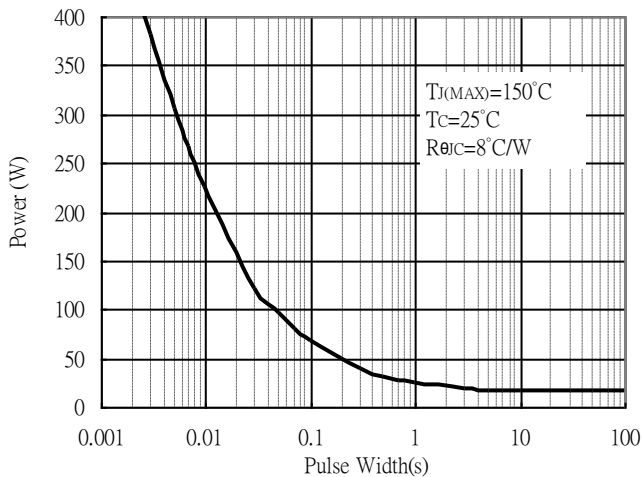

Typical Characteristics(Cont.)

Transient Thermal Response Curves

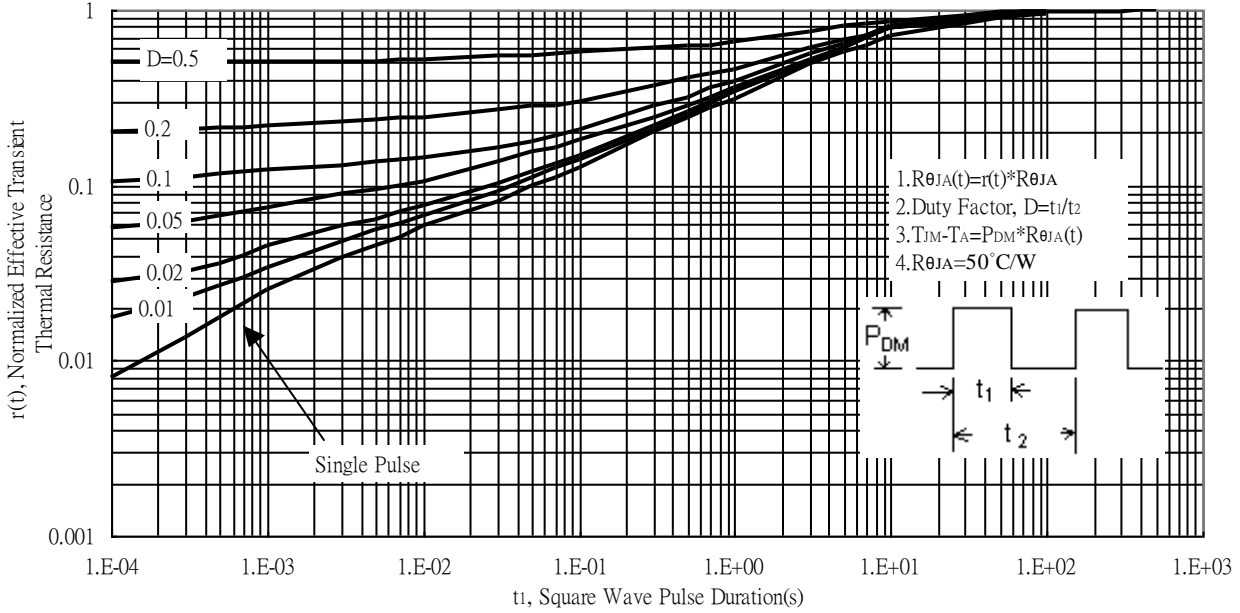

Transient Thermal Response Curves

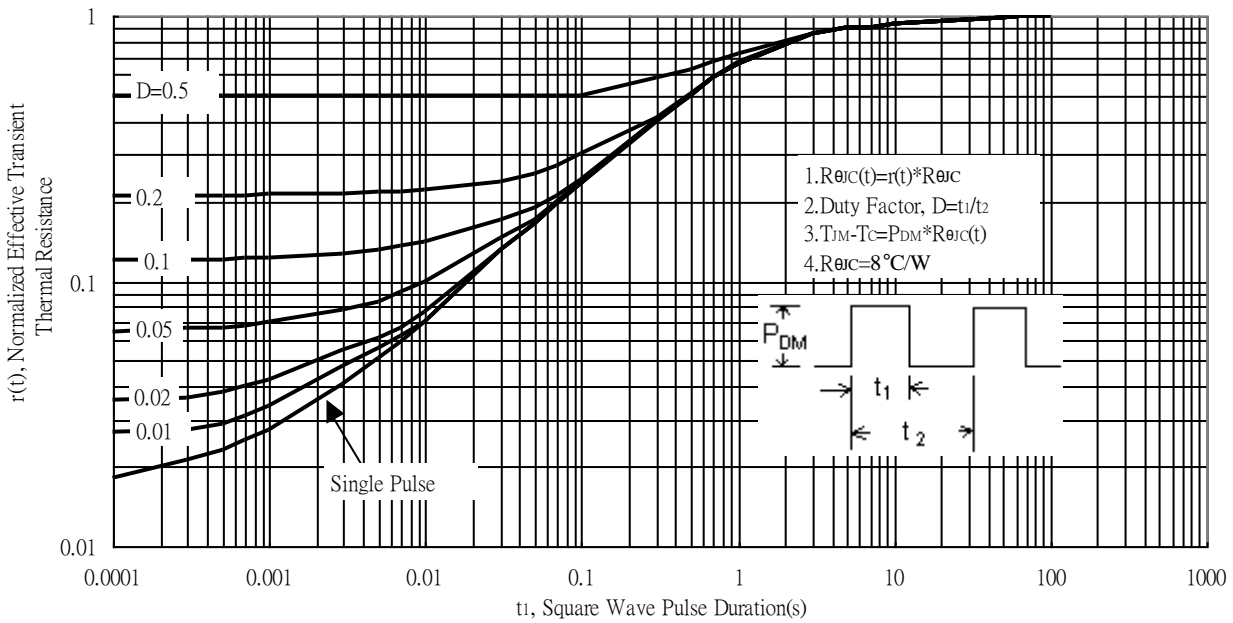

Reel Dimension

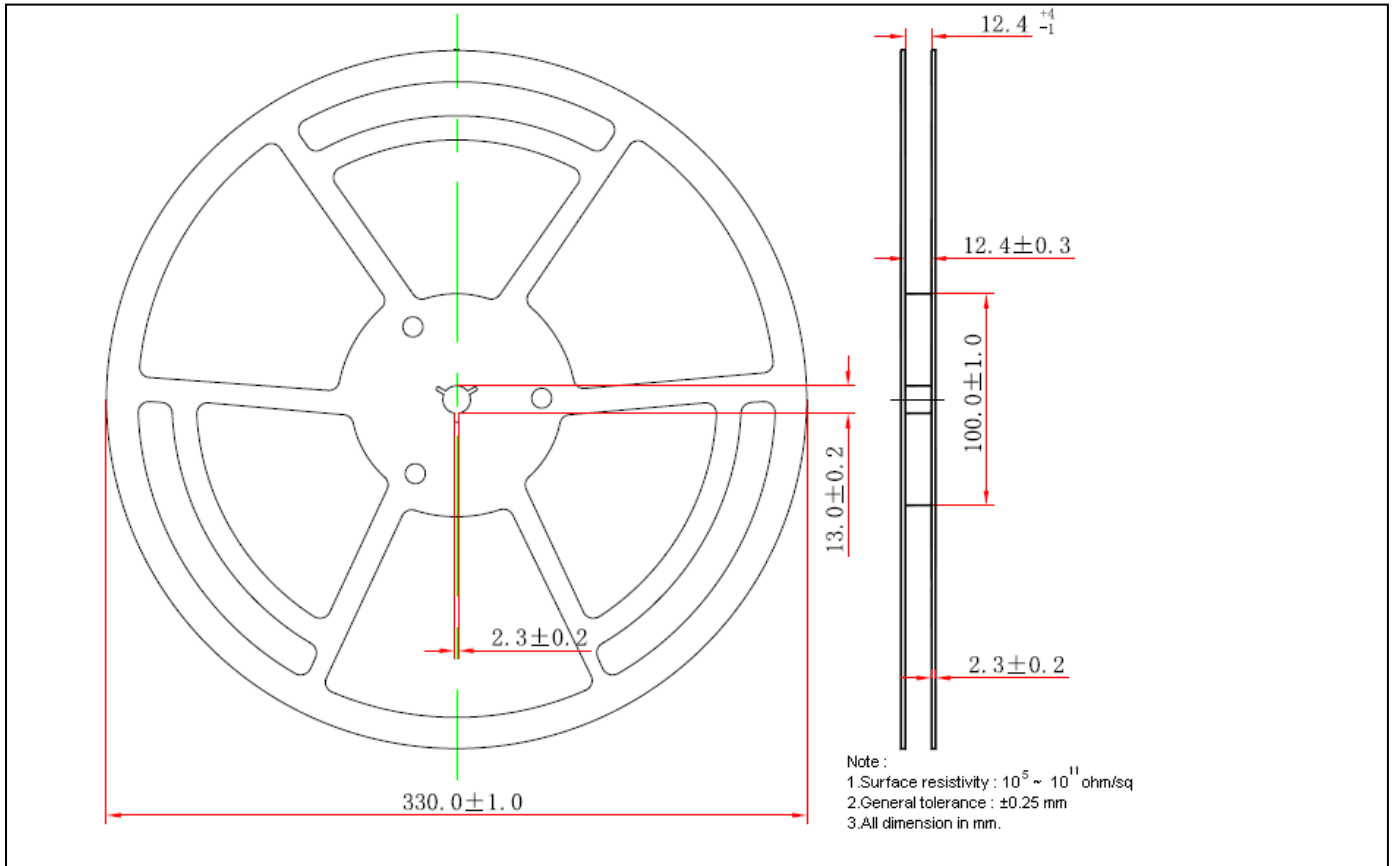

Carrier Tape Dimension

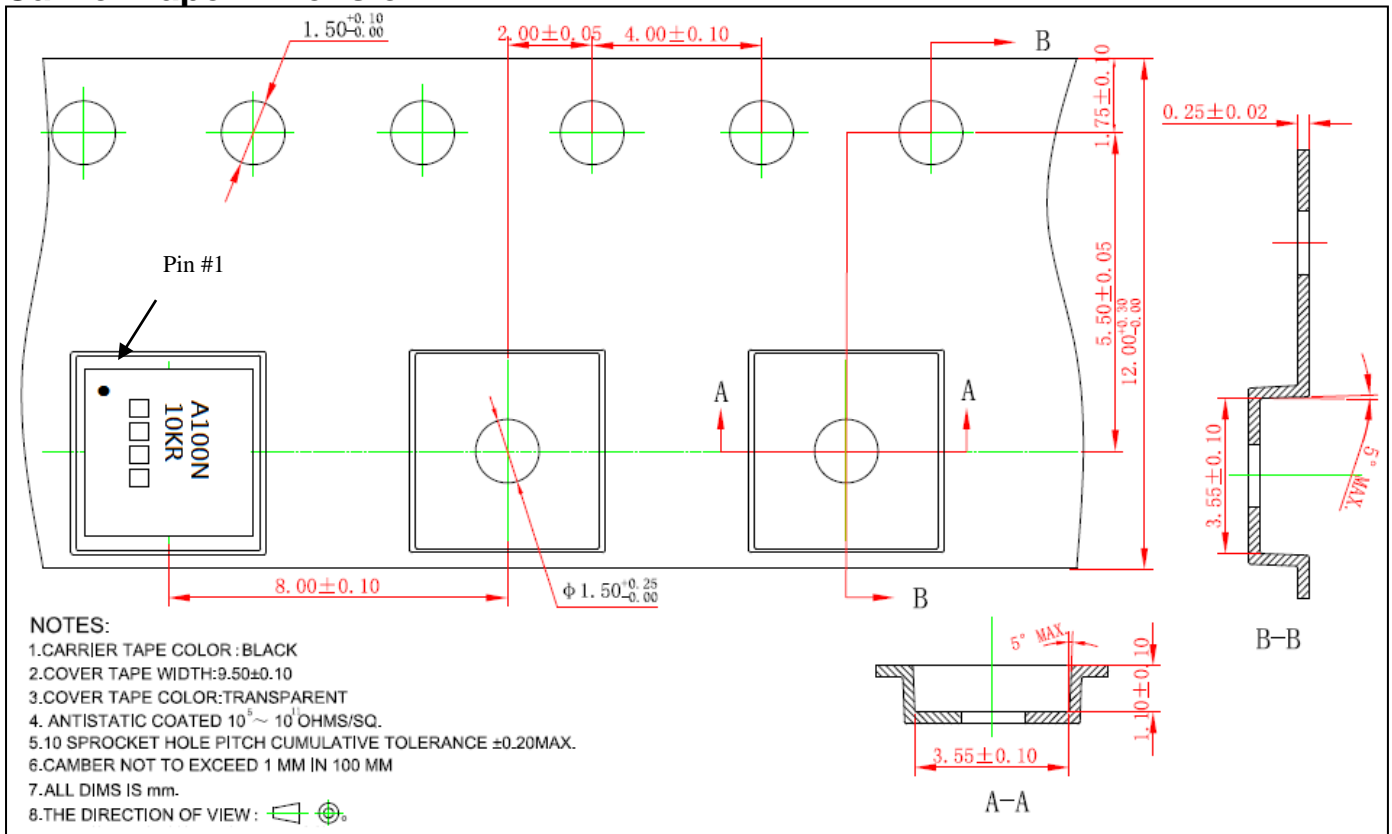

Recommended wave soldering condition

Product	Peak Temperature	Soldering Time
Pb-free devices	260 +0/-5 °C	5 +1/-1 seconds

Recommended temperature profile for IR reflow

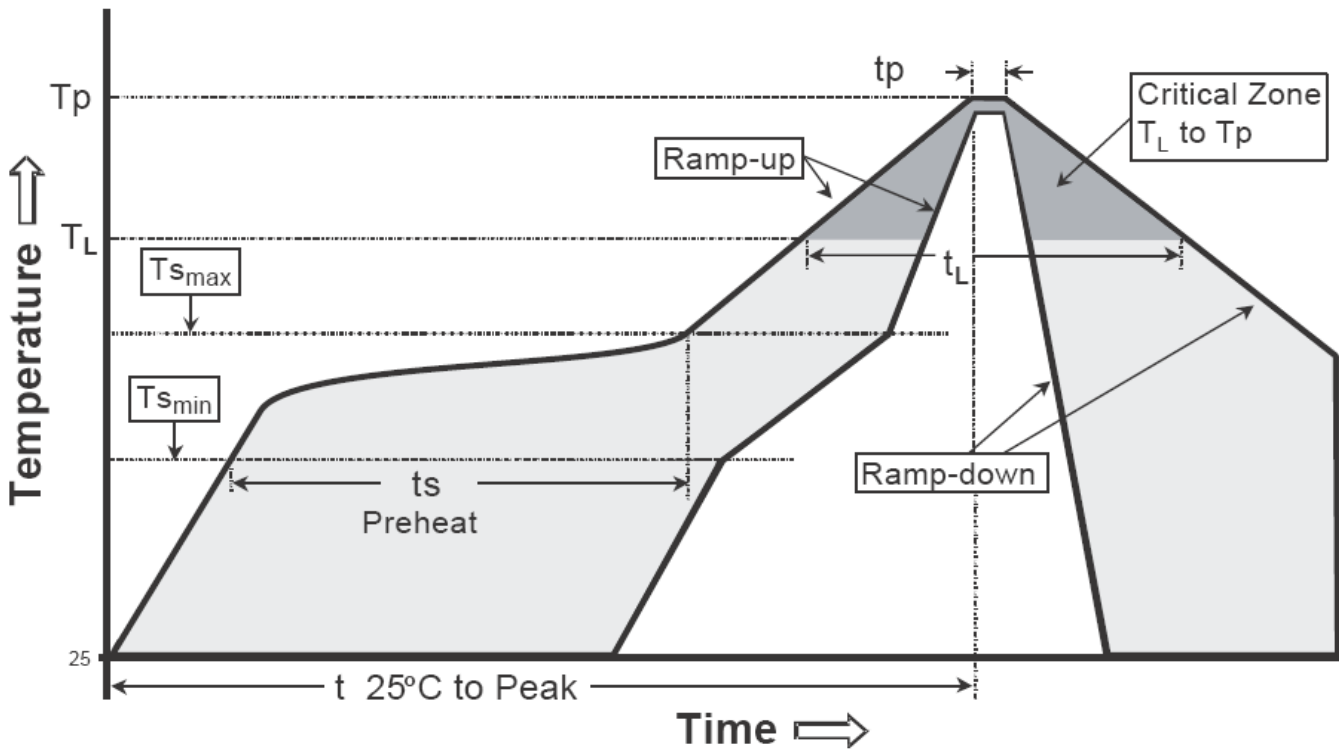

Profile feature	Sn-Pb eutectic Assembly	Pb-free Assembly
Average ramp-up rate (T _{smax} to T _p)	3°C/second max.	3°C/second max.
Preheat		
-Temperature Min(T _{s min})	100°C	150°C
-Temperature Max(T _{s max})	150°C	200°C
-Time(t _{s min} to t _{s max})	60-120 seconds	60-180 seconds
Time maintained above:		
-Temperature (T _L)	183°C	217°C
- Time (t _L)	60-150 seconds	60-150 seconds
Peak Temperature(T _p)	240 +0/-5 °C	260 +0/-5 °C
Time within 5°C of actual peak temperature(tp)	10-30 seconds	20-40 seconds
Ramp down rate	6°C/second max.	6°C/second max.
Time 25 °C to peak temperature	6 minutes max.	8 minutes max.

Note : All temperatures refer to topside of the package, measured on the package body surface.

DFN3x3 Dimension

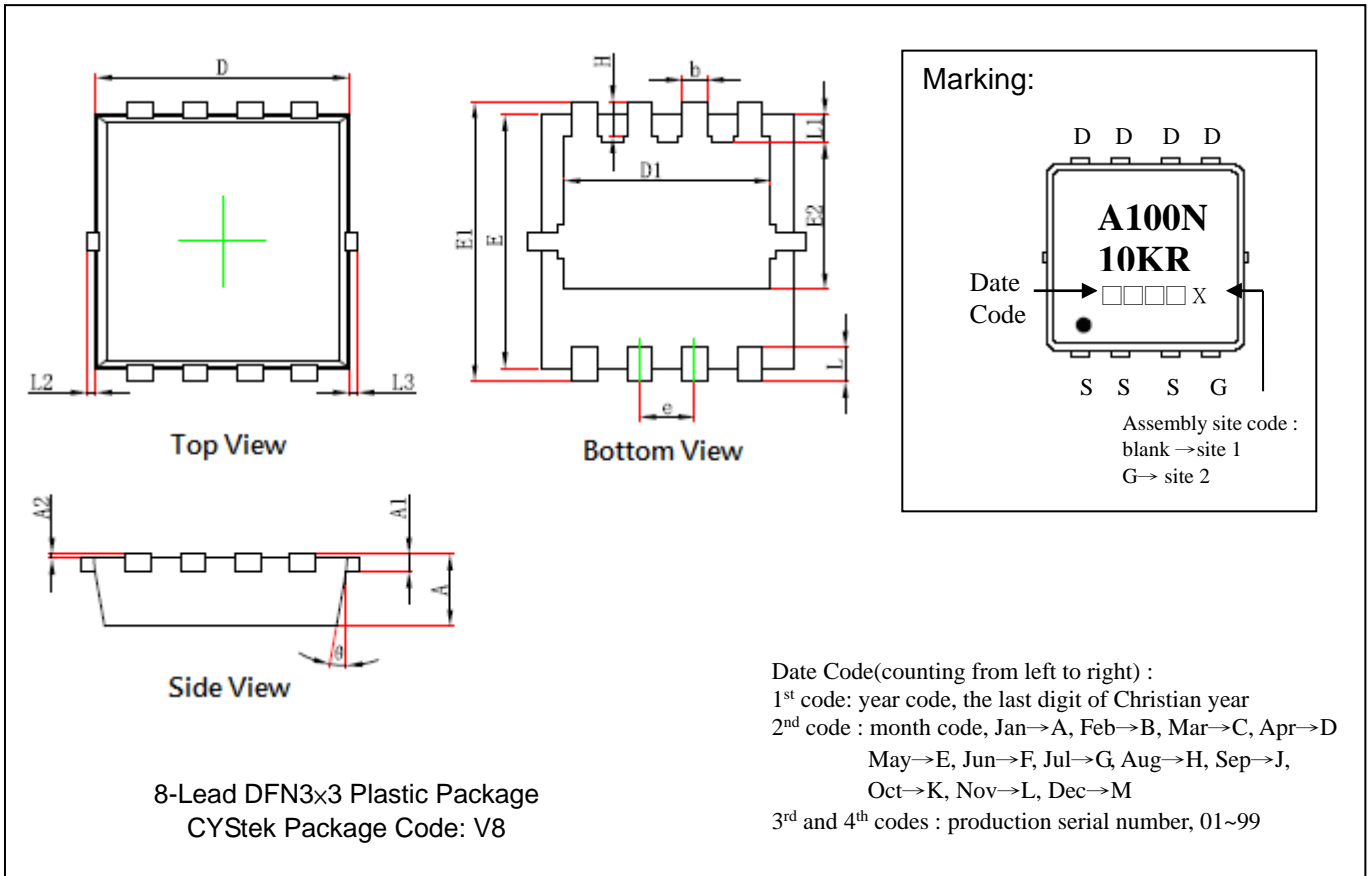

8-Lead DFN3x3 Plastic Package
 CYStek Package Code: V8

Marking:

D D D D
A100N
10KR
 Date Code → □□□□ X
 S S S G
 Assembly site code :
 blank → site 1
 G → site 2

Date Code(counting from left to right) :
 1st code: year code, the last digit of Christian year
 2nd code : month code, Jan→A, Feb→B, Mar→C, Apr→D
 May→E, Jun→F, Jul→G, Aug→H, Sep→J,
 Oct→K, Nov→L, Dec→M
 3rd and 4th codes : production serial number, 01~99

DIM	Inches		Millimeters		DIM	Inches		Millimeters	
	Min.	Max.	Min.	Max.		Min.	Max.	Min.	Max.
A	0.026	0.033	0.650	0.850	b	0.008	0.016	0.200	0.400
A1	0.006	REF	0.152	REF	e	0.022	0.030	0.550	0.750
A2	0.000	0.002	0.000	0.050	L	0.012	0.020	0.300	0.500
D	0.114	0.126	2.900	3.200	L1	0.007	0.019	0.180	0.480
D1	0.091	0.102	2.300	2.600	L2	0.000	0.006	0.000	0.150
E	0.114	0.126	2.900	3.200	L3	0.000	0.006	0.000	0.150
E1	0.124	0.136	3.150	3.450	H	0.012	0.020	0.300	0.515
E2	0.058	0.076	1.480	1.935	θ	8°	13°	8°	13°

Notes: 1.Controlling dimension: millimeters.
 2.Maximum lead thickness includes lead finish thickness, and minimum lead thickness is the minimum thickness of base material.
 3.If there is any question with packing specification or packing method, please contact your local CYStek sales office.

Material:

- Lead: pure tin plated.
- Mold Compound: Epoxy resin family, flammability solid burning class: UL94V-0.

Important Notice:

- All rights are reserved. Reproduction in whole or in part is prohibited without the prior written approval of CYStek.
- CYStek reserves the right to make changes to its products without notice.
- CYStek **semiconductor products are not warranted to be suitable for use in Life-Support Applications, or systems.**
- CYStek assumes no liability for any consequence of customer product design, infringement of patents, or application assistance.