

N-Channel Enhancement Mode Power MOSFET

MTA100N10KRH8

BV_{DSS}	100V
I_D@V_{GS}=10V, T_C=25°C	9.7A
I_D@V_{GS}=10V, T_A=25°C	2.9A
R_{DS(ON)} @ V_{GS}=10V, I_D=2.5A	95mΩ (typ.)
R_{DS(ON)} @ V_{GS}=4.5V, I_D=2.5A	110mΩ (typ.)
R_{DS(ON)} @ V_{GS}=3V, I_D=2.5A	130mΩ (typ.)

Features

- Single Drive Requirement
- Low On-resistance
- Fast Switching Characteristic
- ESD protected gate
- Pb-free lead plating and Halogen-free package

Symbol

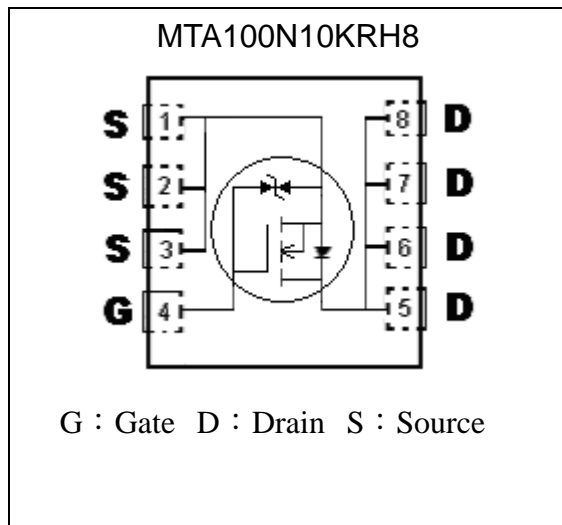

Outline

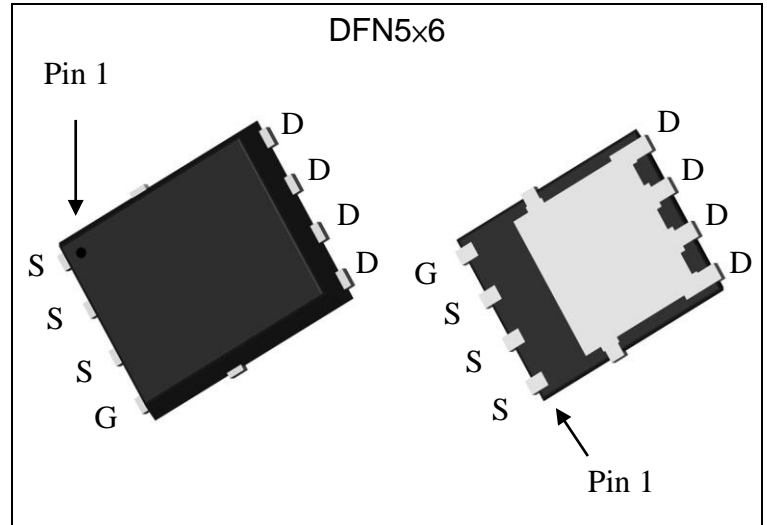

Ordering Information

Device	Package	Shipping
MTA100N10KRH8-0-T6-G	DFN 5 ×6 (Pb-free lead plating and halogen-free package)	3000 pcs / tape & reel

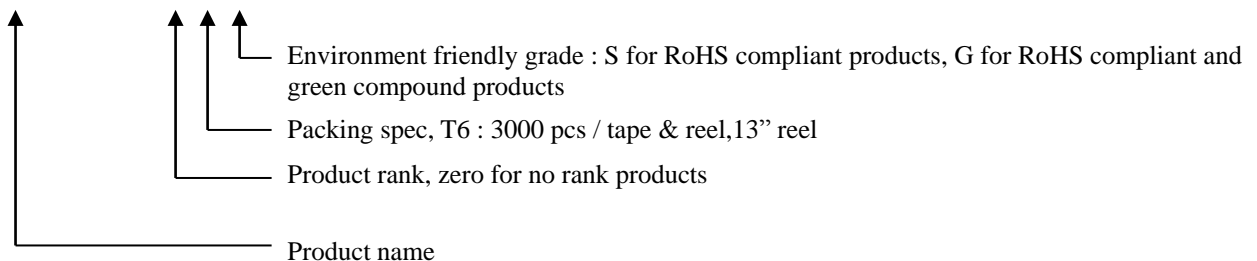



Absolute Maximum Ratings (Ta=25°C)

Parameter	Symbol	Limits	Unit	
Drain-Source Voltage	V _{DS}	100	V	
Gate-Source Voltage	V _{GS}	±20		
Continuous Drain Current @ T _C =25°C, V _{GS} =10V	I _D	9.7	A	
Continuous Drain Current @ T _C =100°C, V _{GS} =10V		6.2		
Continuous Drain Current @ T _A =25°C, V _{GS} =10V	I _{DSM}	2.9 *3		
Continuous Drain Current @ T _A =70°C, V _{GS} =10V		2.3 *3		
Pulsed Drain Current	I _{DM}	20 *1, 2		
Avalanche Current @ L=0.1mH	I _{AS}	10		
Avalanche Energy @ L=0.5mH, I _D =9A, V _{DD} =25V	E _{AS}	20	mJ	
Total Power Dissipation	P _D	T _C =25°C	28	W
		T _C =100°C	11	
	P _D SM	T _A =25°C	2.5 *3	
		T _A =70°C	1.6 *3	
Operating Junction and Storage Temperature Range	T _j , T _{stg}	-55~+150	°C	

100% UIS testing in conditions of V_D=25V, L=0.5mH, V_G=10V, I_L=4A, Rated V_{DS}=100V N-CH

Thermal Data

Parameter	Symbol	Value	Unit
Thermal Resistance, Junction-to-case, max	R _{θJC}	4.5	°C/W
Thermal Resistance, Junction-to-ambient, max	R _{θJA}	50 *3	

- Note : 1.Pulse width limited by maximum junction temperature.
 2.Duty cycle≤1%.
 3.Surface mounted on 1in2 copper pad of FR-4 board, t≤10s; 125 °C/W when mounted on minimum copper pad.

Characteristics (T_C=25°C, unless otherwise specified)

Symbol	Min.	Typ.	Max.	Unit	Test Conditions
Static					
B _V D _{SS}	100	-	-	V	V _{GS} =0V, I _D =250μA
V _{GS(th)}	0.5	-	1.7		V _{DS} = V _{GS} , I _D =250μA
G _{FS} *1	-	24	-	S	V _{DS} =10V, I _D =10A
I _{GSS}	-	-	±10	μA	V _{GS} =±16V, V _{DS} =0V
I _{DSS}	-	-	1		V _{DS} =80V, V _{GS} =0V
	-	-	5		V _{DS} =80V, V _{GS} =0V, T _j =55°C
R _{DS(ON)} *1	-	95	140	mΩ	V _{GS} =10V, I _D =2.5A
	-	110	165		V _{GS} =4.5V, I _D =2.5A
	-	130	310		V _{GS} =3V, I _D =2.5A



Dynamic					
Ciss	-	425	-	pF	V _{DS} =50V, V _{GS} =0V, f=1MHz
Coss	-	30	-		
Crss	-	17	-		
Qg(V _{GS} =10V) *1, 2	-	8	-	nC	V _{DS} =80V, V _{GS} =10V, I _D =2.5A
Qg(V _{GS} =4.5V) *1, 2	-	4.2	-		
Qgs *1, 2	-	1.2	-		
Qgd *1, 2	-	1.5	-	ns	V _{DD} =50V, I _D =2.5A, V _{GS} =10V, R _{GS} =1 Ω
td(ON) *1, 2	-	5	-		
tr *1, 2	-	15.8	-		
td(OFF) *1, 2	-	22	-		
tf *1, 2	-	5	-	Ω	f=1MHz
Rg	-	4.1	-		
Source-Drain Diode					
I _S *1	-	-	9.7	A	
I _{SM} *3	-	-	20		
V _{SD} *1	-	0.89	1.2	V	I _S =5A, V _{GS} =0V
trr	-	17.4	-	ns	I _F =2.5A, dI _F /dt=100A/μs
Qrr	-	14.6	-	nC	

Note : *1.Pulse Test : Pulse Width ≤300μs, Duty Cycle≤2%
 *2.Independent of operating temperature
 *3.Pulse width limited by maximum junction temperature.



Typical Characteristics

Typical Output Characteristics

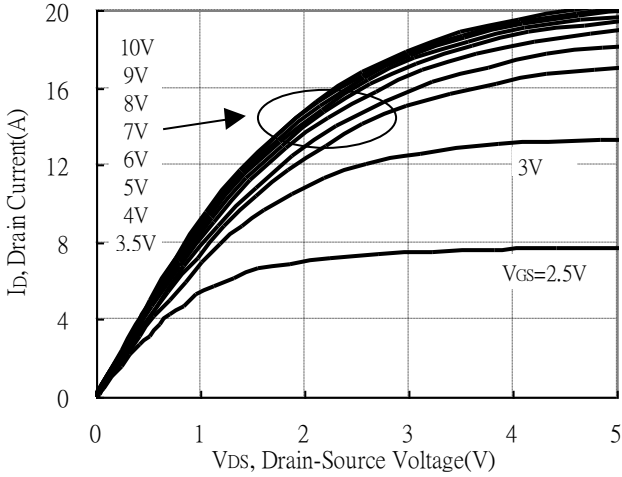

Brekdwn Voltage vs Ambient Temperature

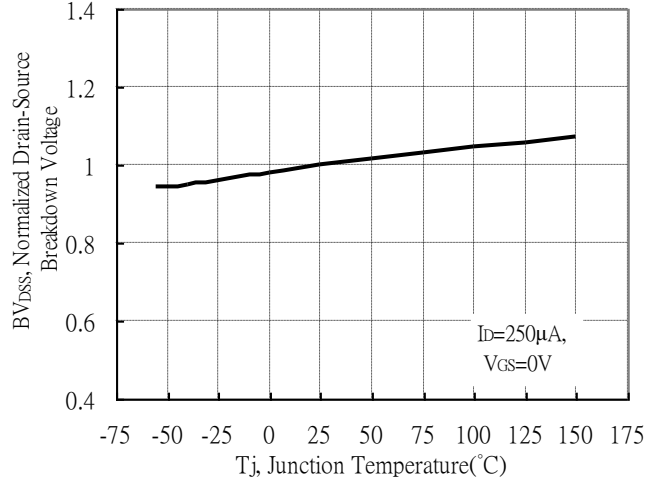

Static Drain-Source On-State resistance vs Drain Current

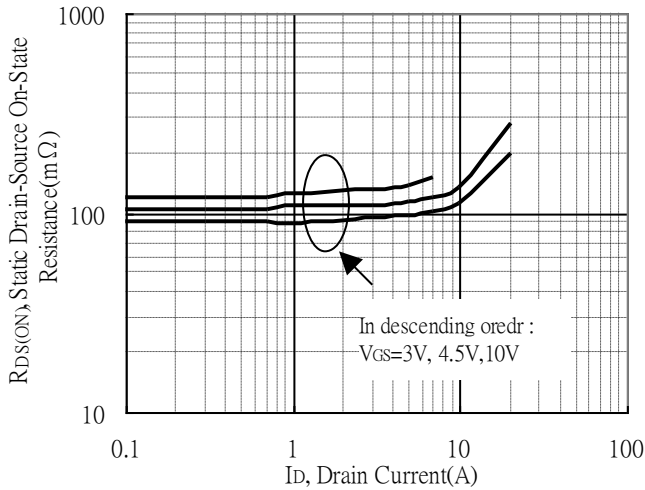

Reverse Drain Current vs Source-Drain Voltage

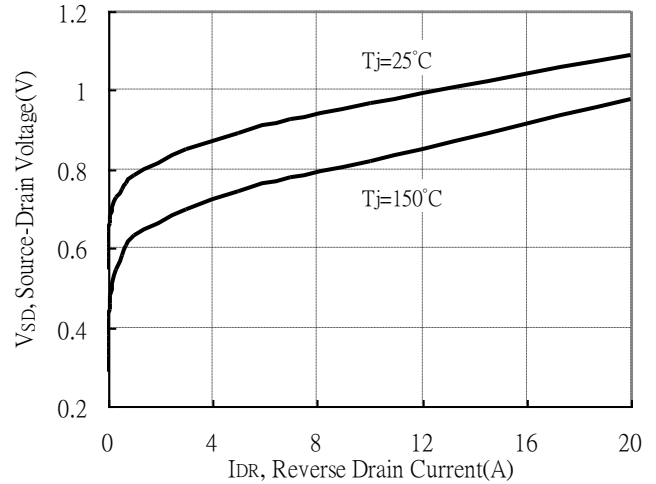

Static Drain-Source On-State Resistance vs Gate-Source Voltage

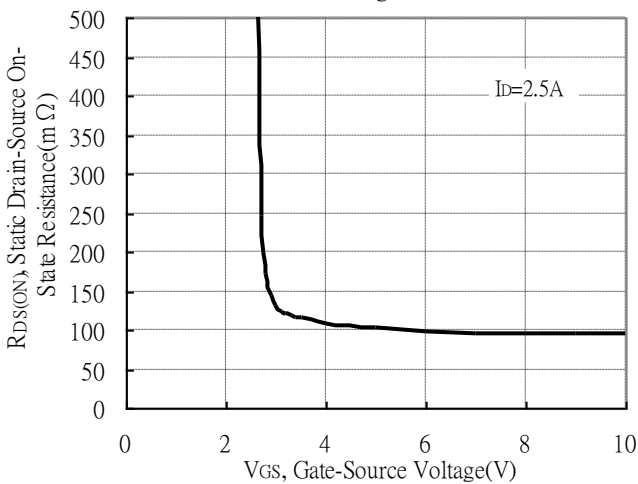

Drain-Source On-State Resistance vs Junction Temperature

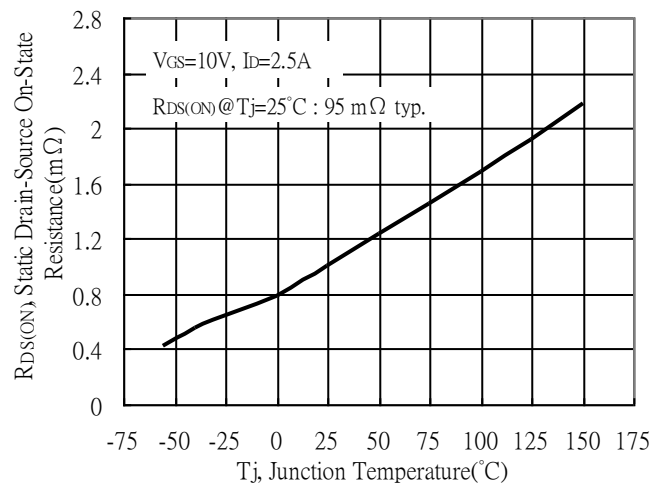

Typical Characteristics(Cont.)

Capacitance vs Drain-to-Source Voltage

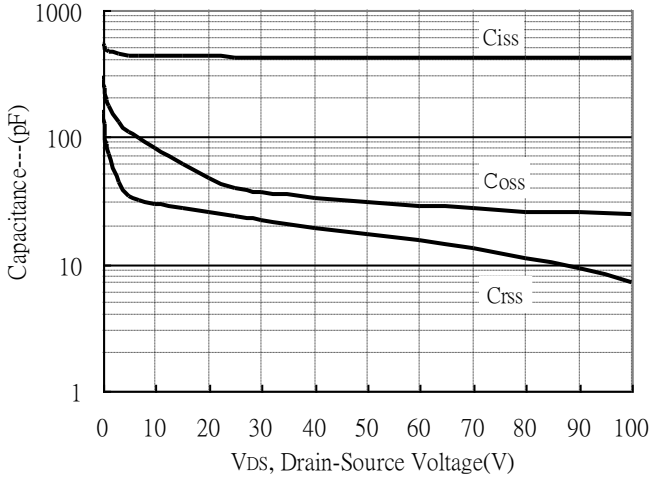

Threshold Voltage vs Junction Temperature

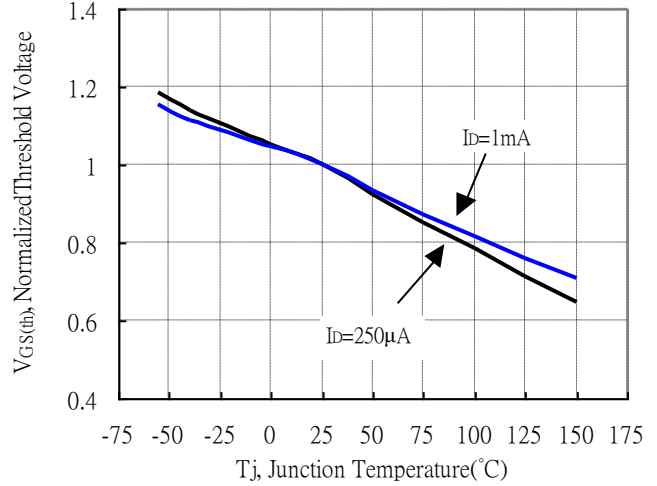

Forward Transfer Admittance vs Drain Current

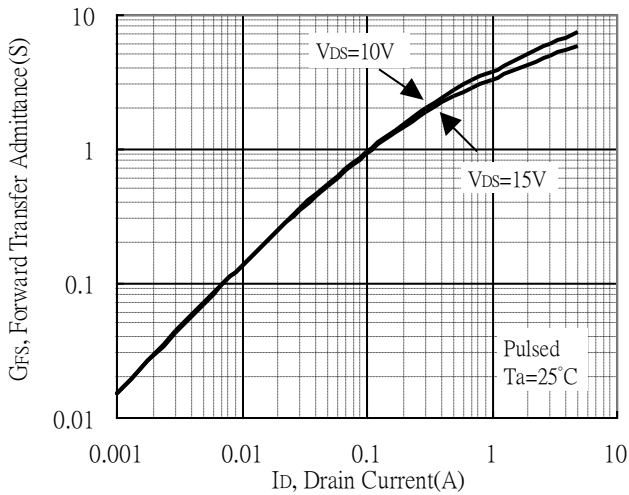

Gate Charge Characteristics

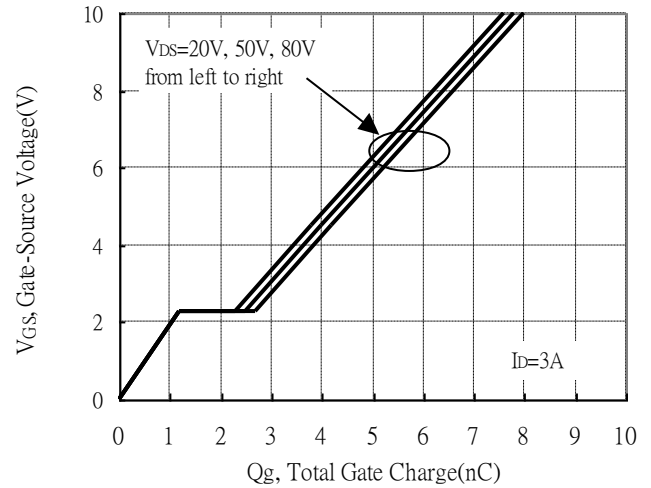

Maximum Safe Operating Area

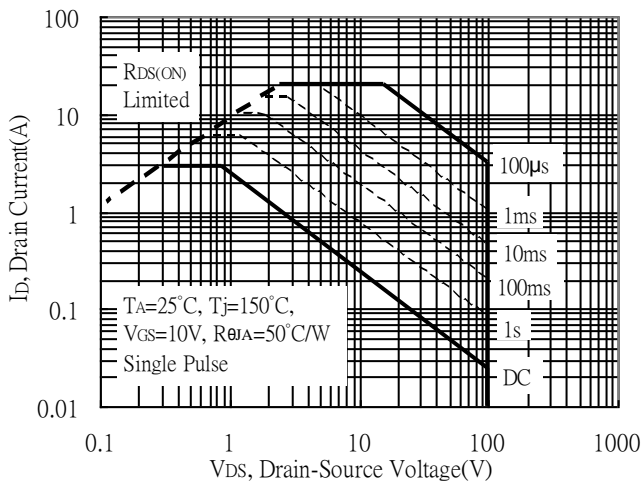

Maximum Drain Current vs Junction Temperature

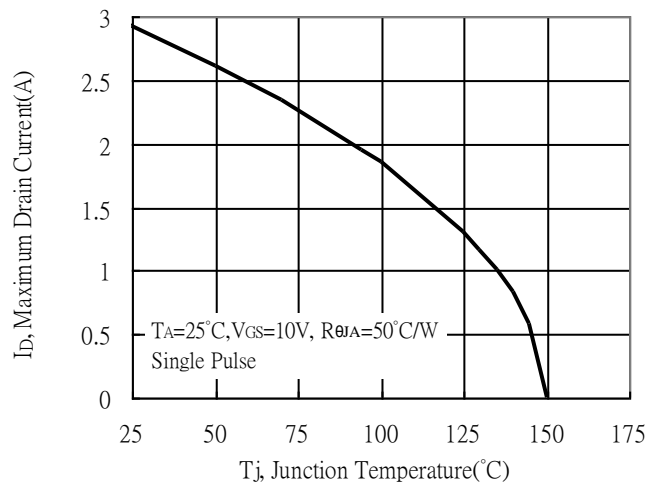



Typical Characteristics(Cont.)

Typical Transfer Characteristics

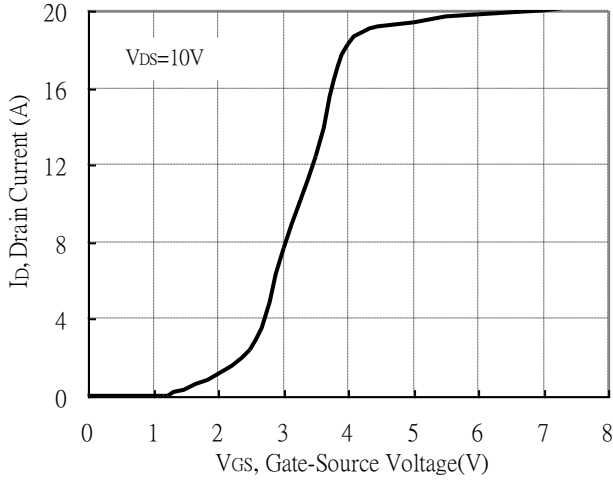

Single Pulse Power Rating, Junction to Ambient
 (Note on page 2)

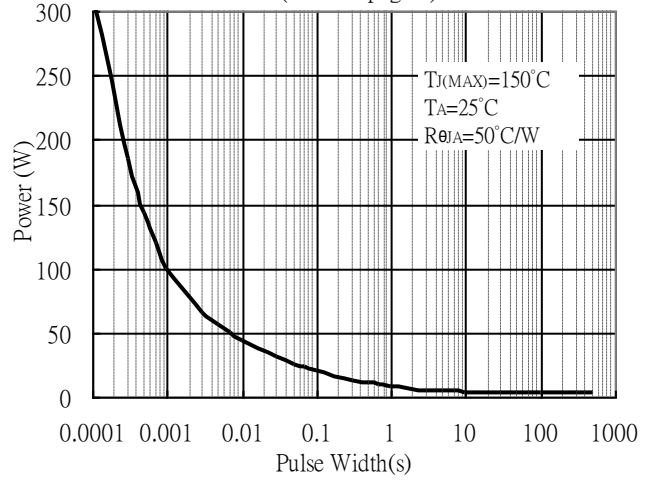

Maximum Drain Current vs Case Temperature

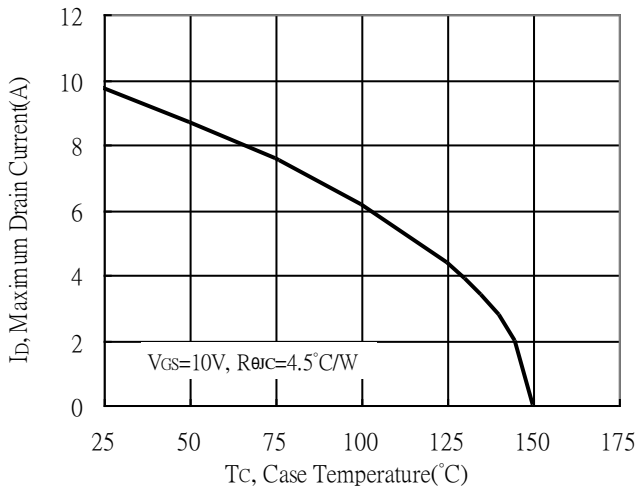

Maximum Safe Operating Area

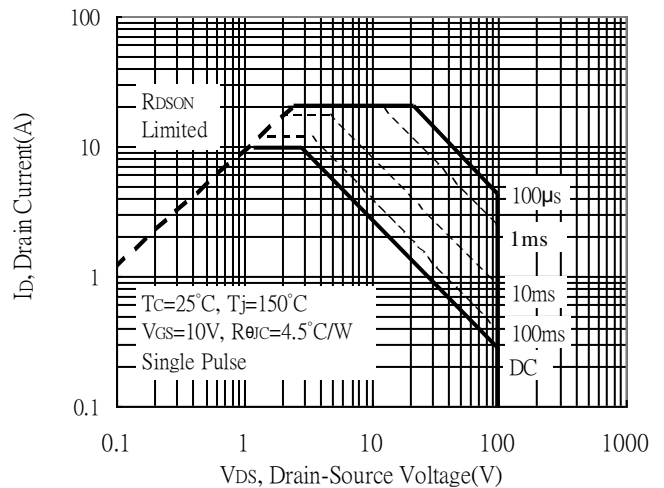

Single Pulse Maximum Power Dissipation

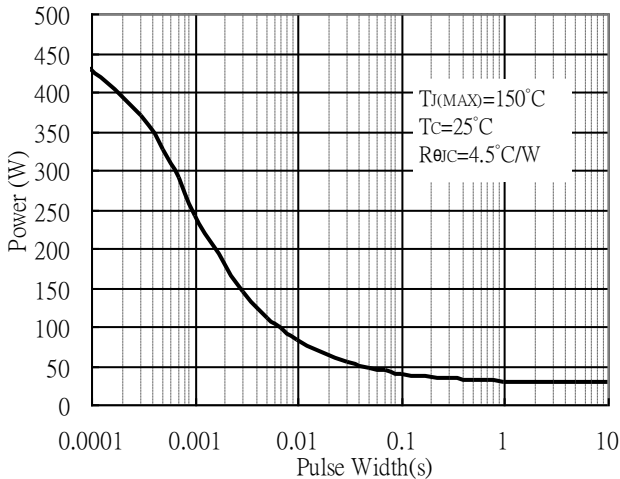



Typical Characteristics(Cont.)

Transient Thermal Response Curves

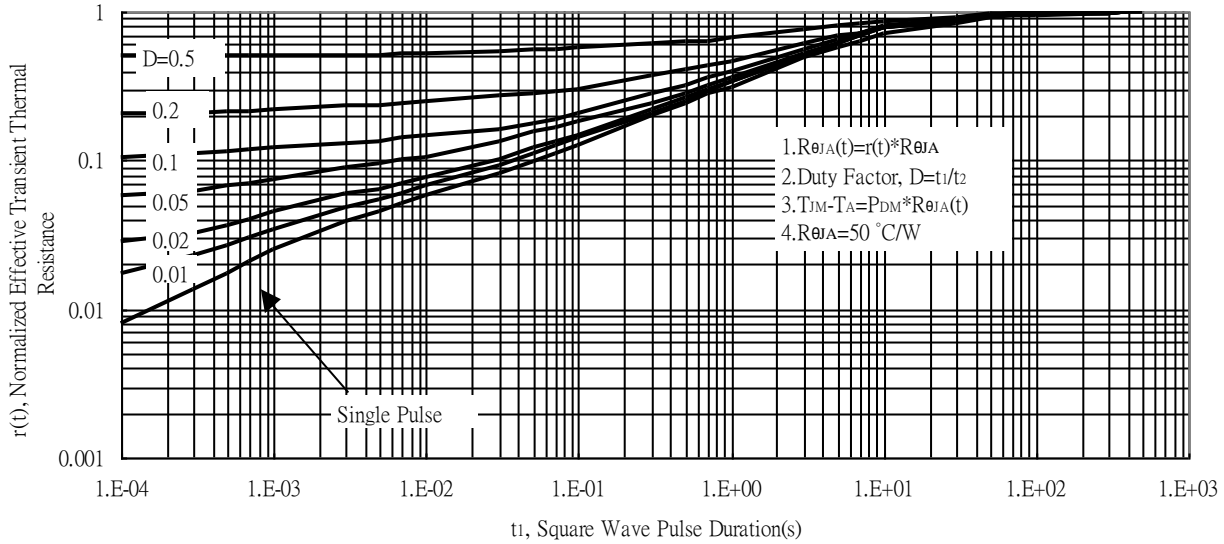

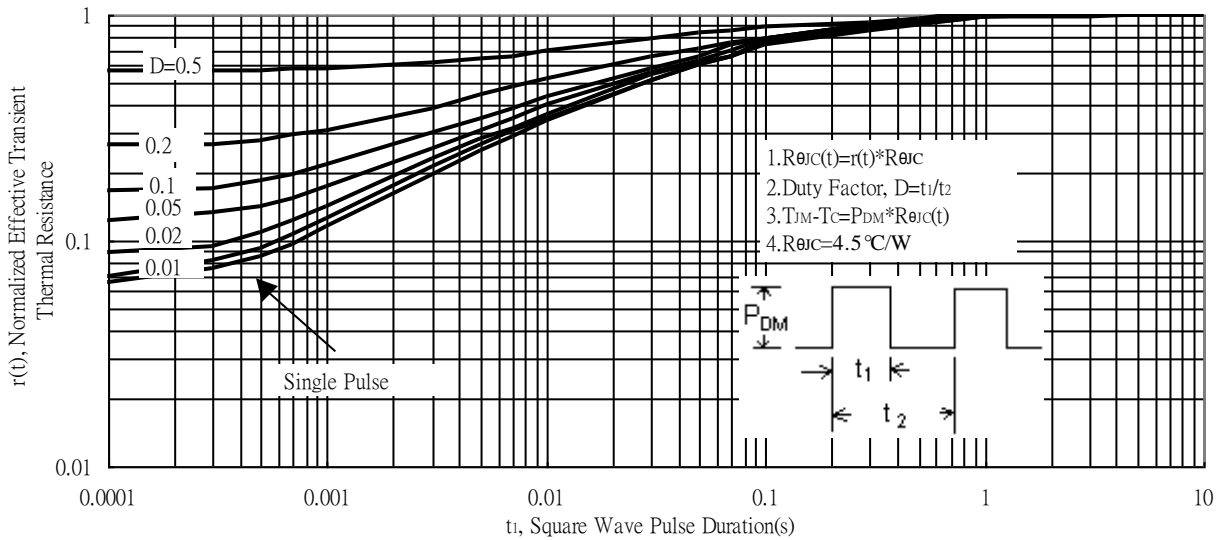

Transient Thermal Response Curves

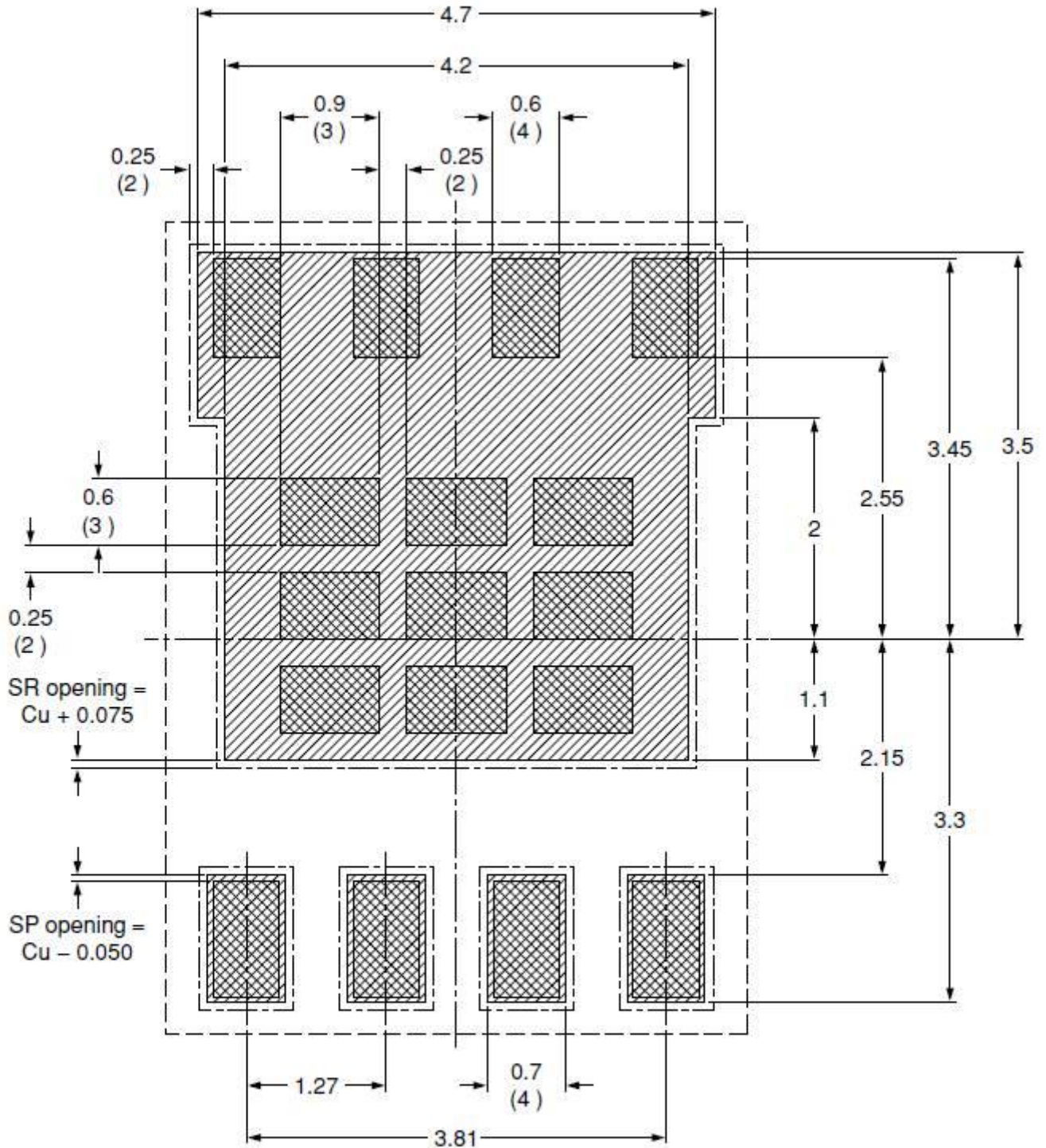

Recommended Soldering Footprint & Stencil Design

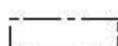
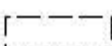

- | | |
|---|--|
|  solder lands |  solder paste
125 μm stencil |
|  solder resist |  occupied area |

unit : mm

Reel Dimension

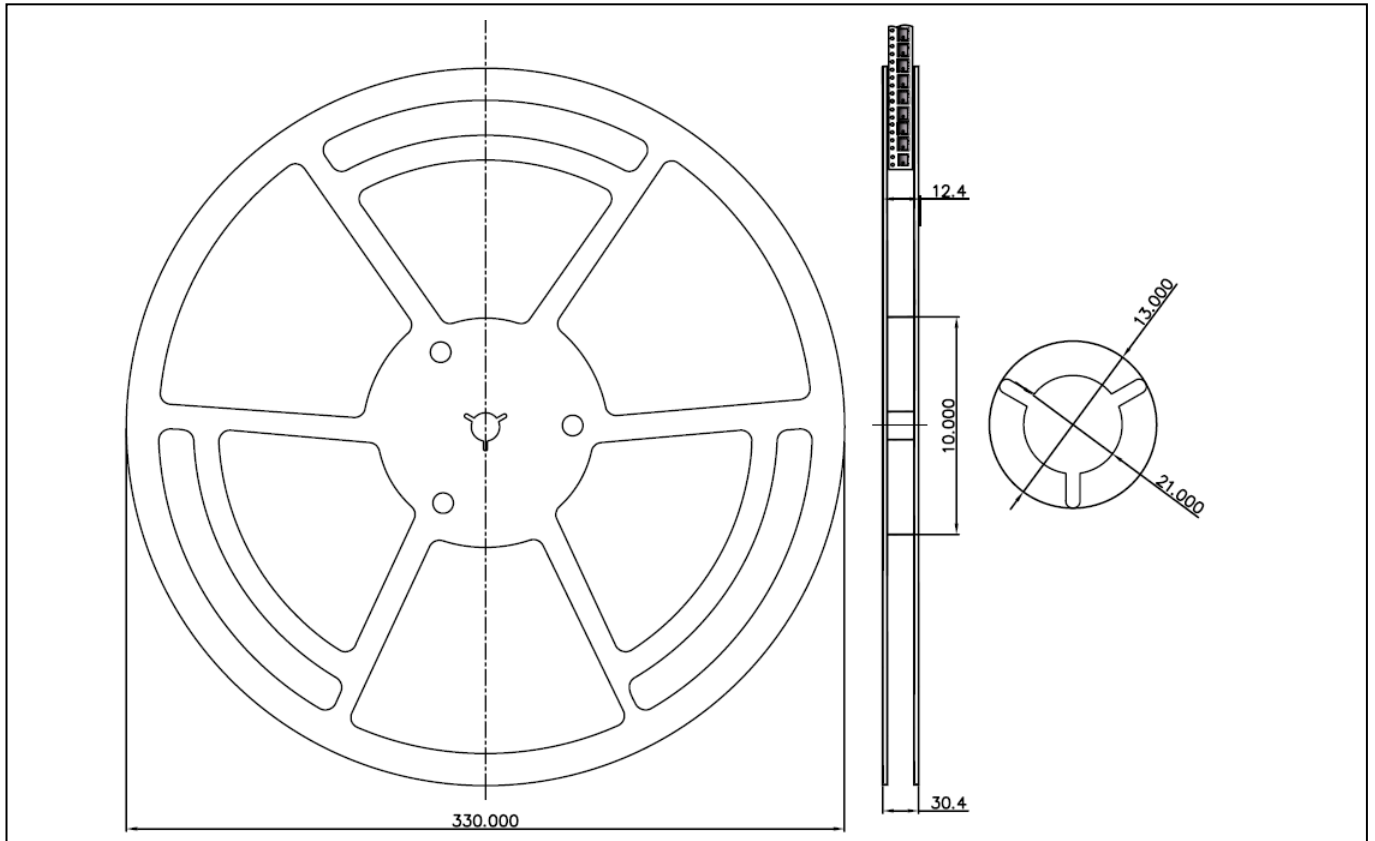

Carrier Tape Dimension

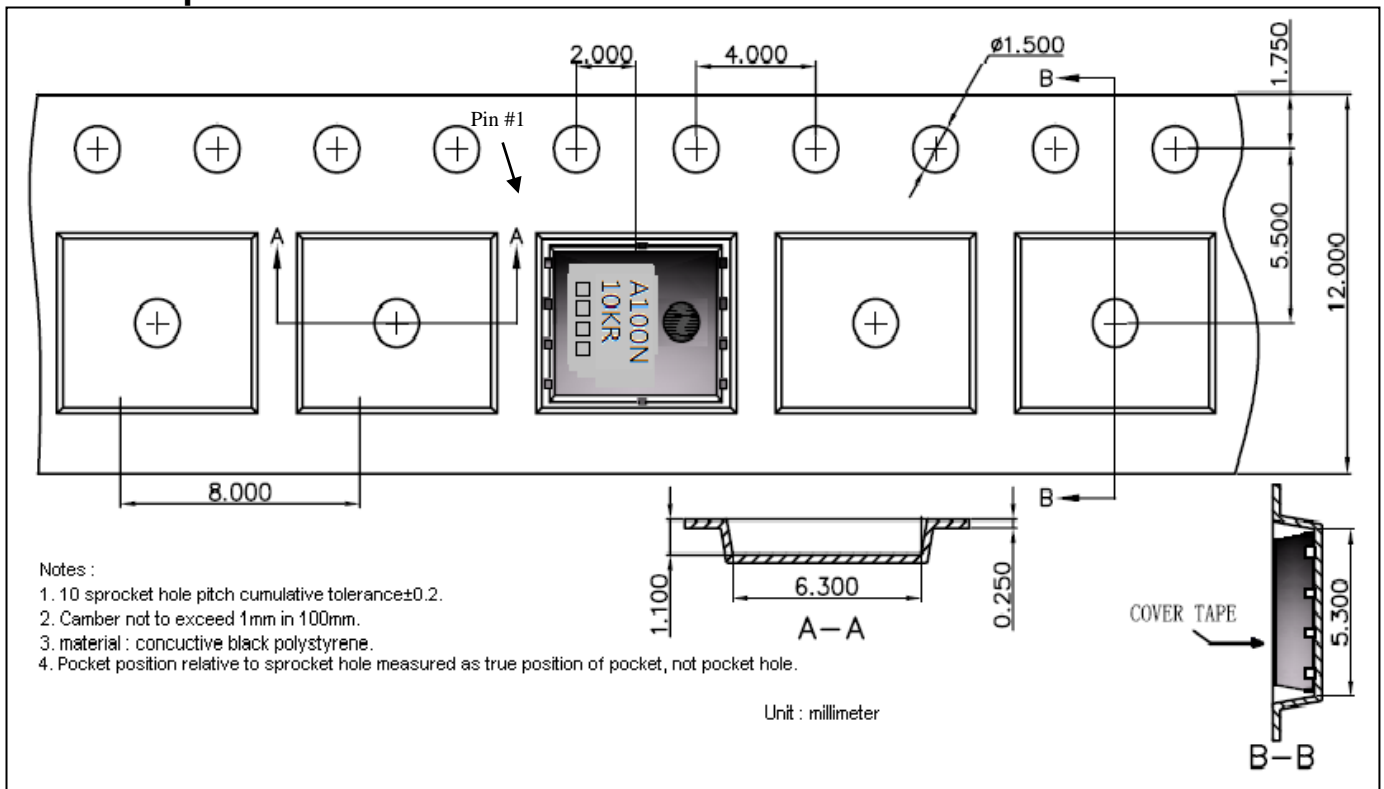

Recommended wave soldering condition

Product	Peak Temperature	Soldering Time
Pb-free devices	260 +0/-5 °C	5 +1/-1 seconds

Recommended temperature profile for IR reflow

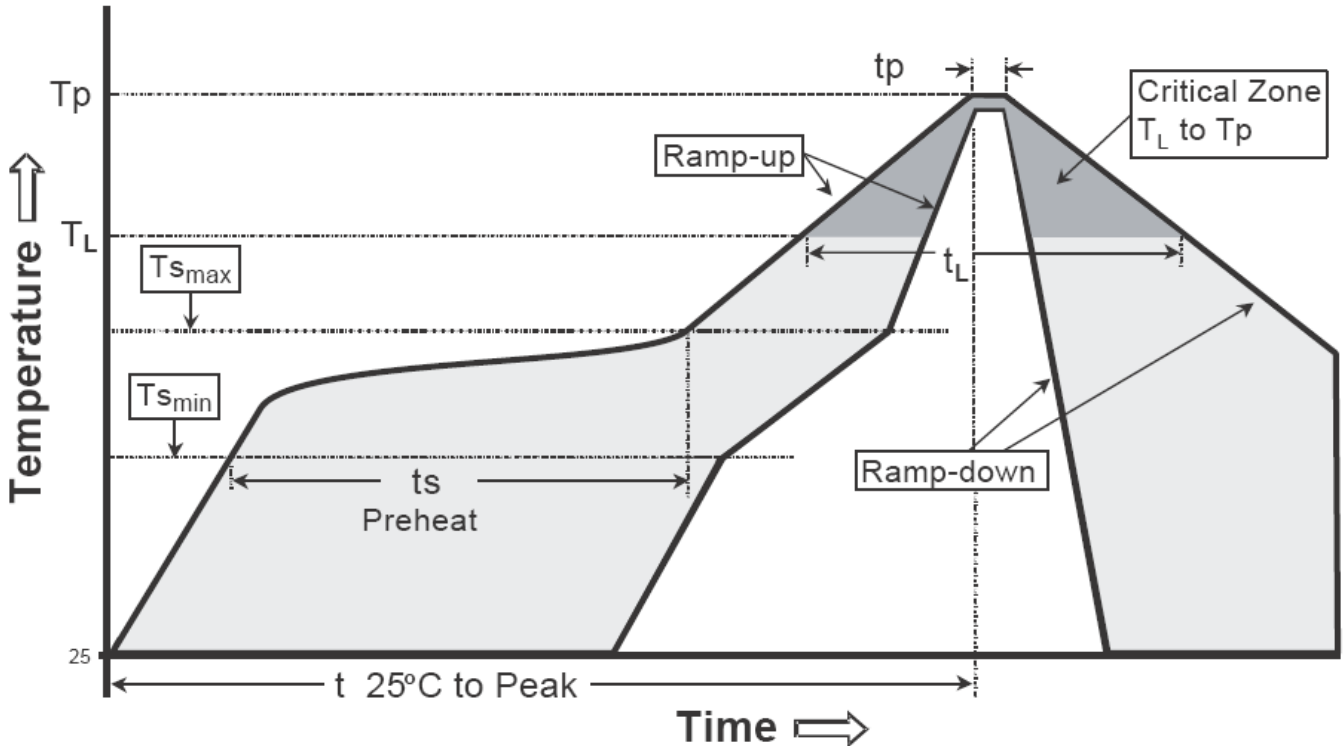

Profile feature	Sn-Pb eutectic Assembly	Pb-free Assembly
Average ramp-up rate (T _{smax} to T _p)	3°C/second max.	3°C/second max.
Preheat		
-Temperature Min(T _{s min})	100°C	150°C
-Temperature Max(T _{s max})	150°C	200°C
-Time(t _{s min} to t _{s max})	60-120 seconds	60-180 seconds
Time maintained above:		
-Temperature (T _L)	183°C	217°C
- Time (t _L)	60-150 seconds	60-150 seconds
Peak Temperature(T _p)	240 +0/-5 °C	260 +0/-5 °C
Time within 5°C of actual peak temperature(tp)	10-30 seconds	20-40 seconds
Ramp down rate	6°C/second max.	6°C/second max.
Time 25 °C to peak temperature	6 minutes max.	8 minutes max.

Note : All temperatures refer to topside of the package, measured on the package body surface.

DFN5x6 Dimension

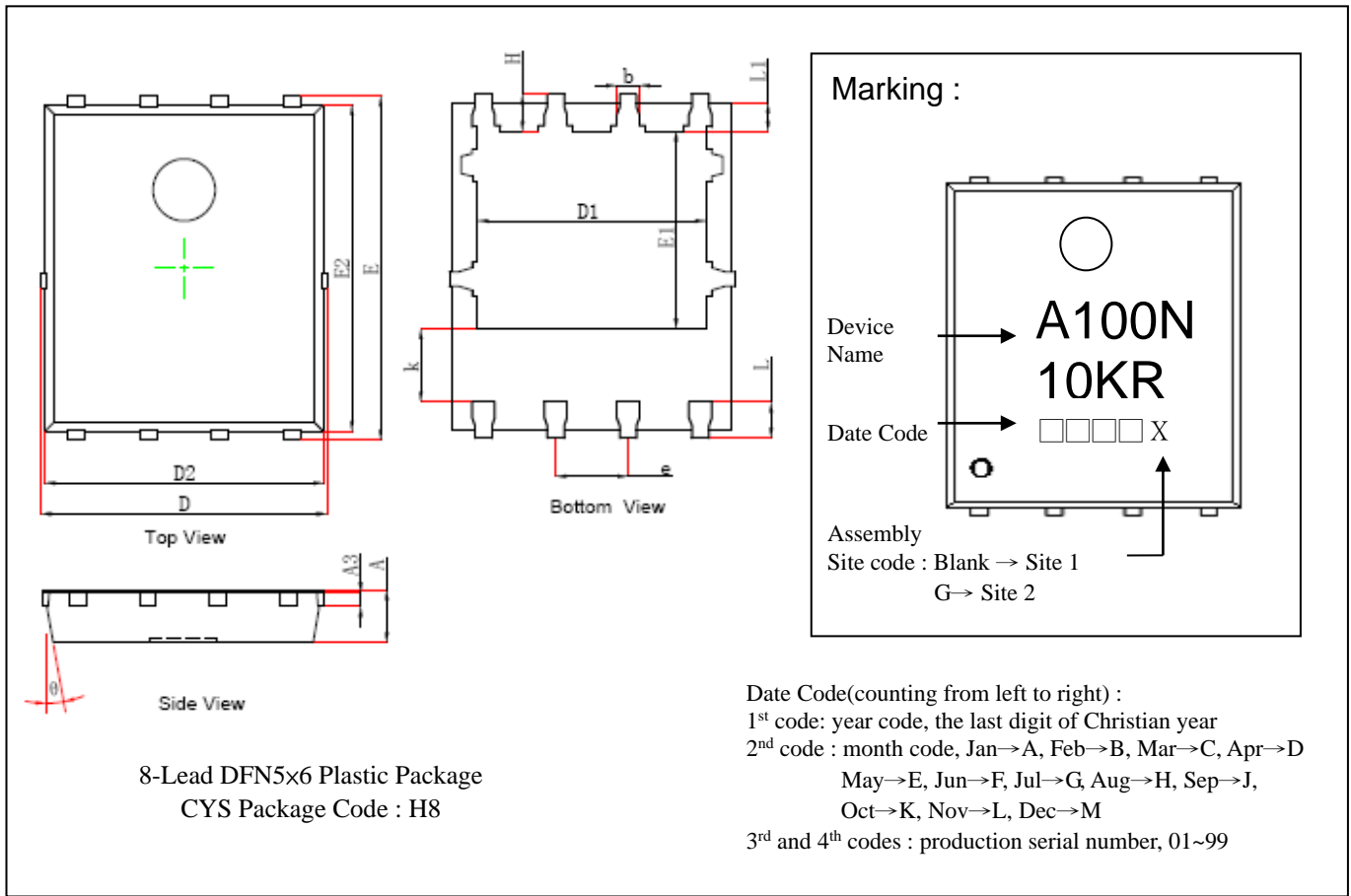

8-Lead DFN5x6 Plastic Package
 CYS Package Code : H8

Marking :

Device Name → A100N
 10KR

Date Code → □□□□ X

Assembly Site code : Blank → Site 1
 G → Site 2

Date Code(counting from left to right) :
 1st code: year code, the last digit of Christian year
 2nd code : month code, Jan→A, Feb→B, Mar→C, Apr→D
 May→E, Jun→F, Jul→G, Aug→H, Sep→J,
 Oct→K, Nov→L, Dec→M
 3rd and 4th codes : production serial number, 01~99

DIM	Millimeters		Inches		DIM	Millimeters		Inches	
	Min.	Max.	Min.	Max.		Min.	Max.	Min.	Max.
A	0.900	1.100	0.035	0.043	k	1.100	-	0.043	-
A3	0.200	0.300	0.008	0.012	b	0.330	0.510	0.013	0.020
D	4.944	5.096	0.195	0.201	e	1.270 TYP.		0.050 TYP.	
E	5.900	6.126	0.232	0.241	L	0.510	0.711	0.020	0.028
D1	3.670	4.110	0.144	0.162	L1	0.310	0.576	0.012	0.023
E1	3.375	3.780	0.133	0.149	H	0.410	0.726	0.016	0.029
D2	4.800	5.000	0.189	0.197	θ	8°	12°	8°	12°
E2	5.674	5.826	0.223	0.229					

Notes: 1.Controlling dimension: millimeters.
 2.Maximum lead thickness includes lead finish thickness, and minimum lead thickness is the minimum thickness of base material.
 3.If there is any question with packing specification or packing method, please contact your local CYStek sales office.

Material:

- Lead: Pure tin plated.
- Mold Compound: Epoxy resin family, flammability solid burning class: UL94V-0.

Important Notice:

- All rights are reserved. Reproduction in whole or in part is prohibited without the prior written approval of CYStek.
- CYStek reserves the right to make changes to its products without notice.
- CYStek **semiconductor products are not warranted to be suitable for use in Life-Support Applications, or systems.**
- CYStek assumes no liability for any consequence of customer product design, infringement of patents, or application assistance.