

Dual N-Channel Enhancement Mode Power MOSFET

MTA020A01Q8

BV_{DSS}	14V
I_D@V_{GS}=10V, T_A=25°C	7A
I_D@V_{GS}=10V, T_A=70°C	5.6A
R_{DS(on)}@V_{GS}=4.5V, I_D=7A	15.4mΩ (typ)
R_{DS(on)}@V_{GS}=2.5V, I_D=5A	21.7mΩ (typ)

Features

- Simple drive requirement
- Low on-resistance
- Fast switching speed
- Dual N-ch MOSFET package
- Pb-free lead plating & Halogen-free package

Equivalent Circuit

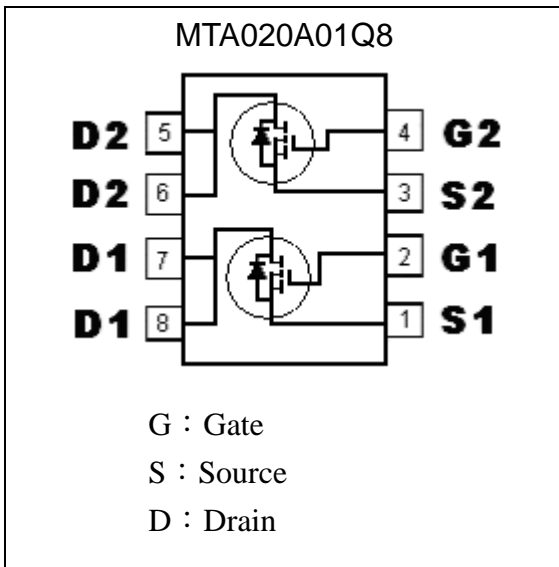

Outline

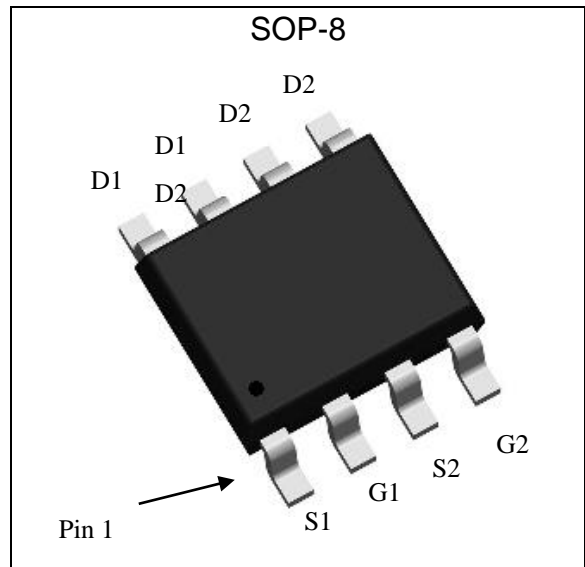

Ordering Information

Device	Package	Shipping
MTA020A01Q8-0-T3-G	SOP-8 (Pb-free lead plating and halogen-free package)	2500 pcs / tape & reel

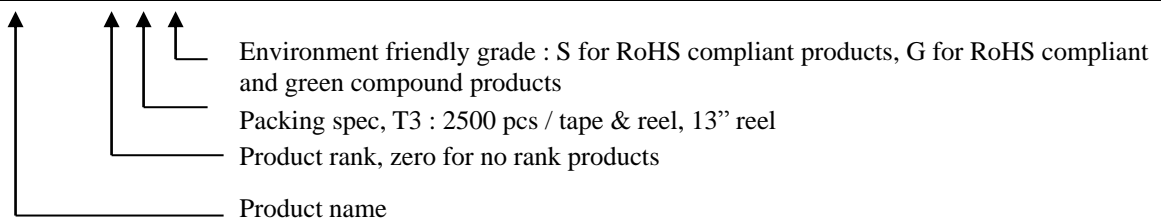



Absolute Maximum Ratings (Ta=25°C)

Parameter	Symbol	Limits	Unit
Drain-Source Voltage	V _{DS}	14	V
Gate-Source Voltage	V _{GS}	±8	
Continuous Drain Current @ V _{GS} =10V, T _C =25°C	I _D	11.3	A
Continuous Drain Current @ V _{GS} =10V, T _C =100°C		7.2	
Continuous Drain Current @ V _{GS} =10V, T _A =25°C		7 (Note 2)	
Continuous Drain Current @ V _{GS} =10V, T _A =70°C		5.6 (Note 2)	
Pulsed Drain Current	I _{DM}	20 (Note 1)	
Power Dissipation for Dual Operation	P _D	2	W
Power Dissipation for Single Operation		1.6 (Note 2)	
		0.9 (Note 3)	
Operating Junction and Storage Temperature Range	T _j , T _{stg}	-55~+150	°C

Thermal Data

Parameter	Symbol	Value	Unit
Thermal Resistance, Junction-to-case, max	R _{θJC}	35	°C/W
Thermal Resistance, Junction-to-ambient, max, dual	R _{θJA}	62.5	
Thermal Resistance, Junction-to-ambient, max, single operation		78 (Note 2)	
		135 (Note 3)	

- Note : 1. Pulse width limited by maximum junction temperature
 2. Surface mounted on 1 in² copper pad of FR-4 board, pulse width≤10s.
 3. Surface mounted on minimum copper pad, pulse width≤10s.

Characteristics (Tj=25°C, unless otherwise specified)

Symbol	Min.	Typ.	Max.	Unit	Test Conditions
Static					
B _V DSS	14	-	-	V	V _{GS} =0V, I _D =250μA
V _{GS(th)}	0.5	-	1.0		V _{DS} = V _{GS} , I _D =250μA
G _{FS} *1	-	9.8	-	S	V _{DS} = 5V, I _D =7A
I _{GSS}	-	-	±100	nA	V _{GS} =±8V, V _{DS} =0V
I _{DSS}	-	-	1	μA	V _{DS} = 14V, V _{GS} = 0V
	-	-	25		V _{DS} = 10V, V _{GS} = 0V, T _j =70°C
R _{DS(ON)} *1	-	15.4	22	mΩ	V _{GS} = 4.5V, I _D =7A
	-	21.7	32		V _{GS} = 2.5V, I _D =5A
Dynamic					
Q _g *1, 2	-	6.3	-	nC	V _{DS} =10V, I _D =7A, V _{GS} =4.5V
Q _{gs} *1, 2	-	0.7	-		
Q _{gd} *1, 2	-	2.7	-		
t _{d(ON)} *1, 2	-	5.6	-	ns	V _{DS} =10V, I _D =7A, V _{GS} =5V, R _G =3.3Ω
t _r *1, 2	-	16	-		
t _{d(OFF)} *1, 2	-	22.8	-		
t _f *1, 2	-	9.8	-		

Ciss	-	374	-	pF	V _{GS} =0V, V _{DS} =10V, f=1MHz
Coss	-	112	-		
Crss	-	96	-		
Rg	-	2.4	-	Ω	f=1MHz
Source-Drain Diode					
I _S *1	-	-	2.3	A	
I _{SM} *3	-	-	9.2		
V _{SD} *1	-	0.88	1.2	V	I _S =7A, V _{GS} =0V
trr *1	-	10	-	ns	I _F =7A, dI _F /dt=100A/μs
Q _{rr} *1	-	1.4	-	nC	

Note : *1.Pulse Test : Pulse Width ≤300μs, Duty Cycle≤2%
 *2.Independent of operating temperature
 *3.Pulse width limited by maximum junction temperature.

Recommended Soldering Footprint

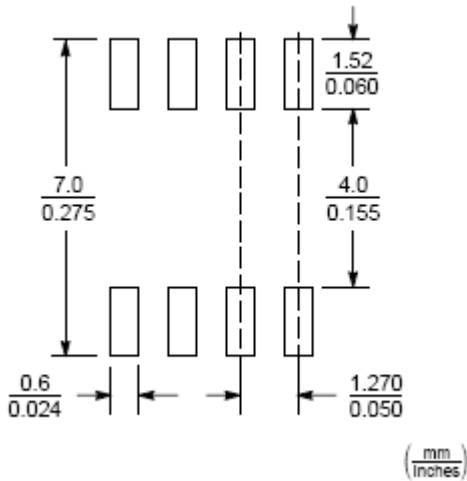



Typical Characteristics

Typical Output Characteristics

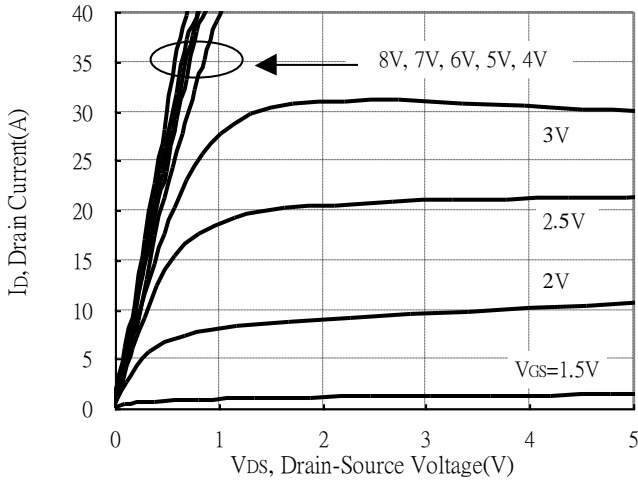

Brekdown Voltage vs Ambient Temperature

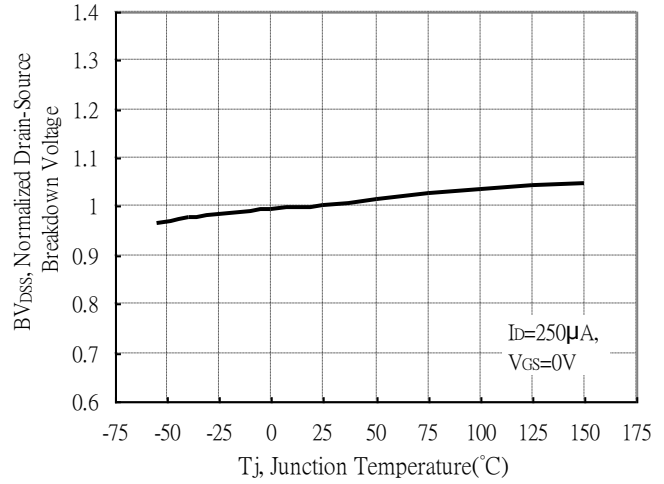

Static Drain-Source On-State resistance vs Drain Current

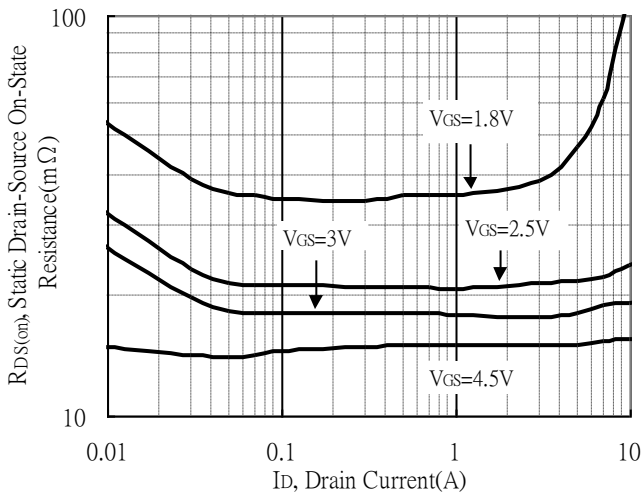

Reverse Drain Current vs Source-Drain Voltage

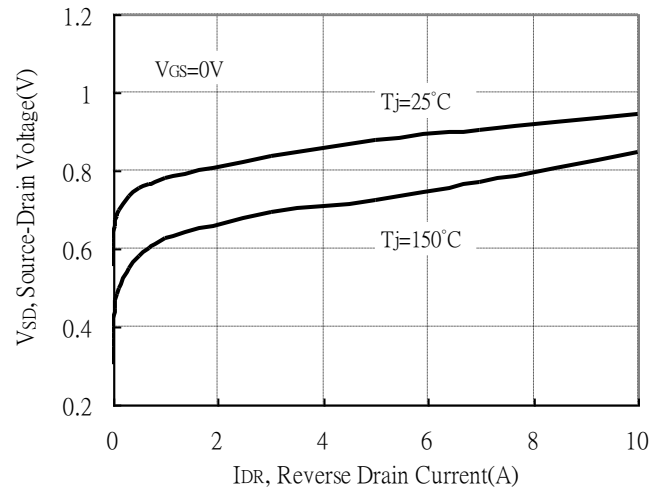

Static Drain-Source On-State Resistance vs Gate-Source Voltage

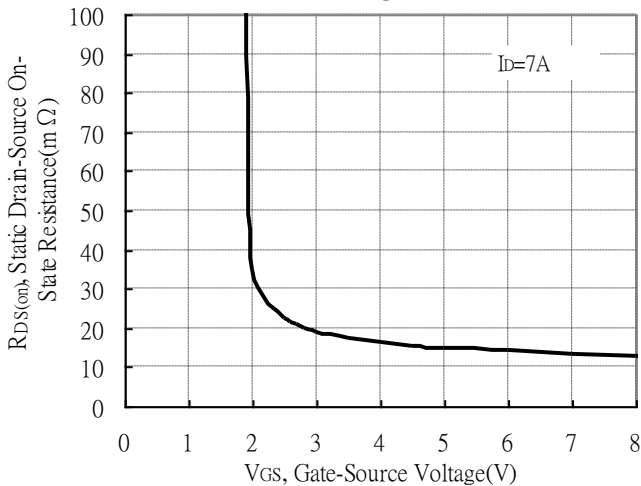

Drain-Source On-State Resistance vs Junction Temperature

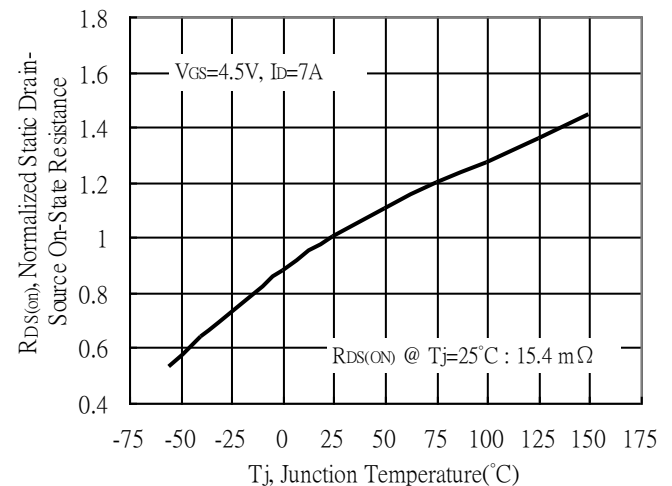

Typical Characteristics(Cont.)

Capacitance vs Drain-to-Source Voltage

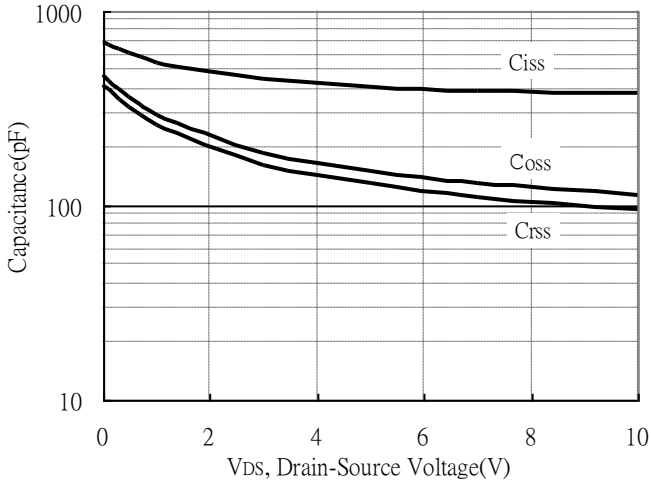

Threshold Voltage vs Junction Temperature

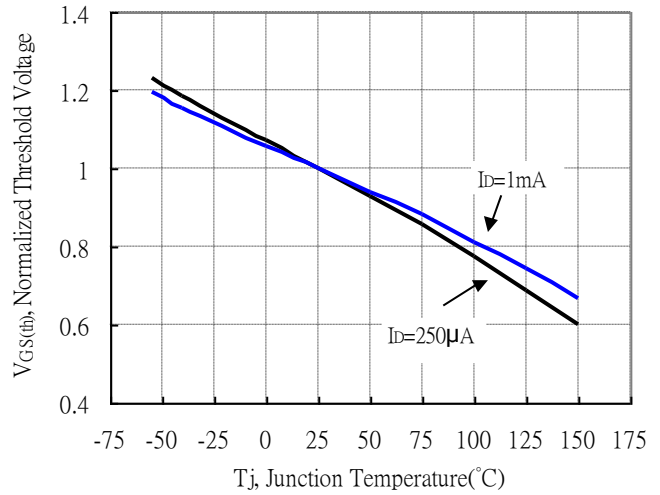

Forward Transfer Admittance vs Drain Current

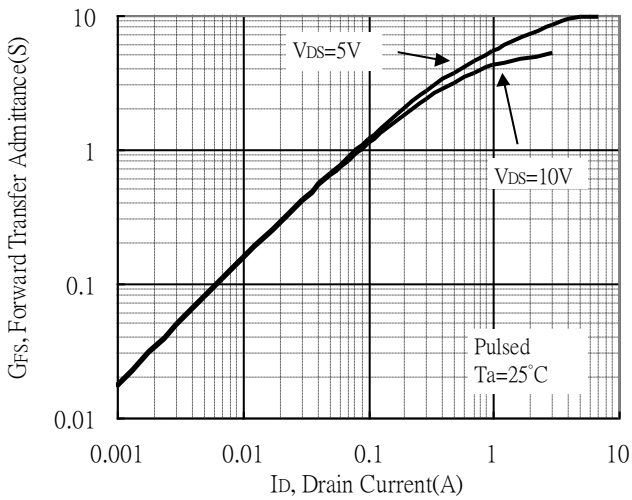

Gate Charge Characteristics

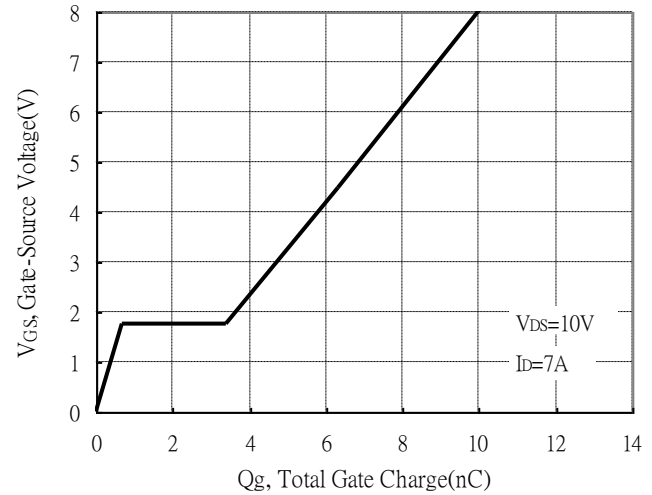

Maximum Safe Operating Area

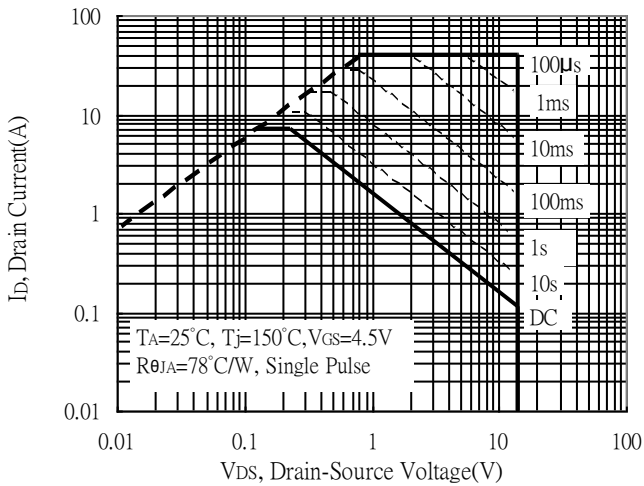

Maximum Drain Current vs Junction Temperature

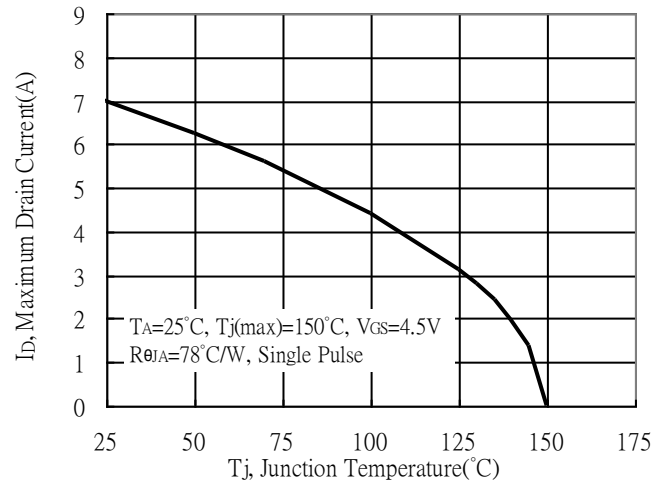



Typical Characteristics(Cont.)

Typical Transfer Characteristics

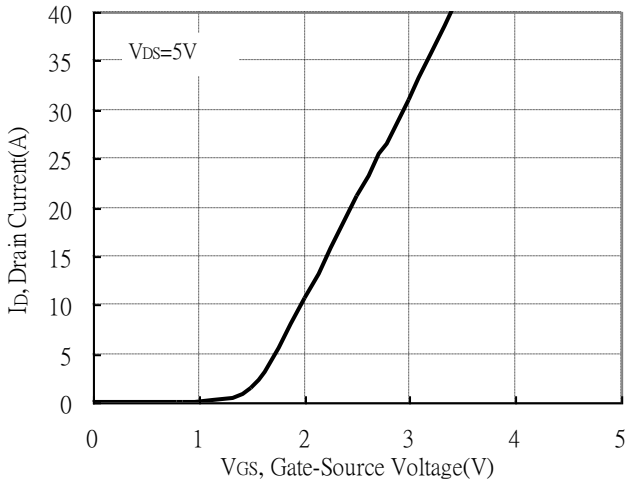

Single Pulse Power Rating, Junction to Ambient
 (Note on page 2)

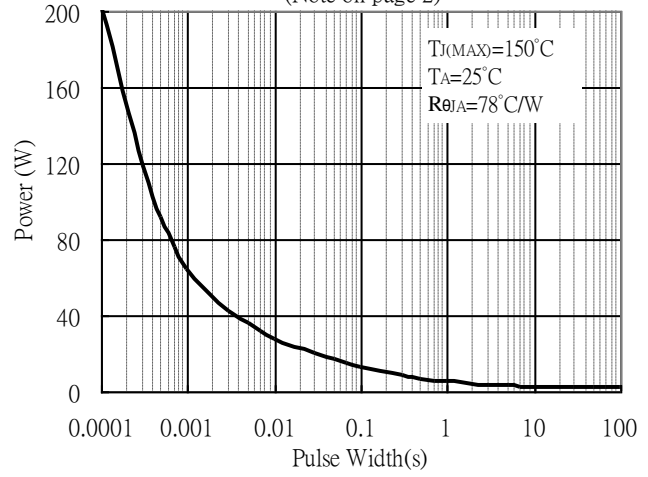

Transient Thermal Response Curves

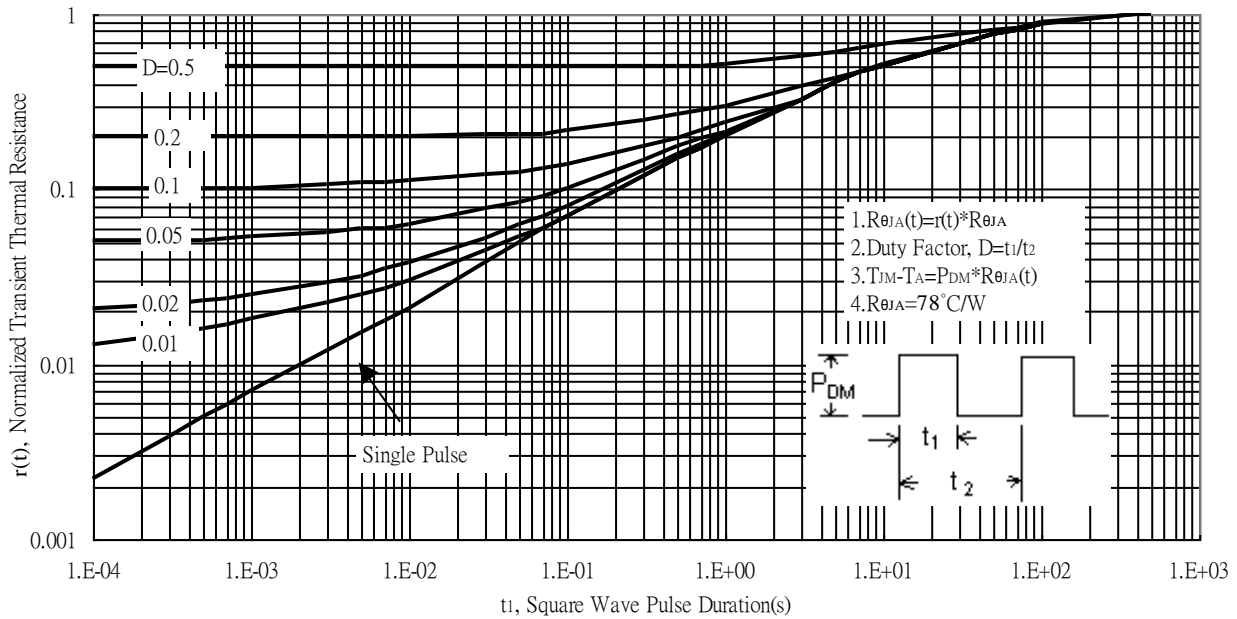

Reel Dimension

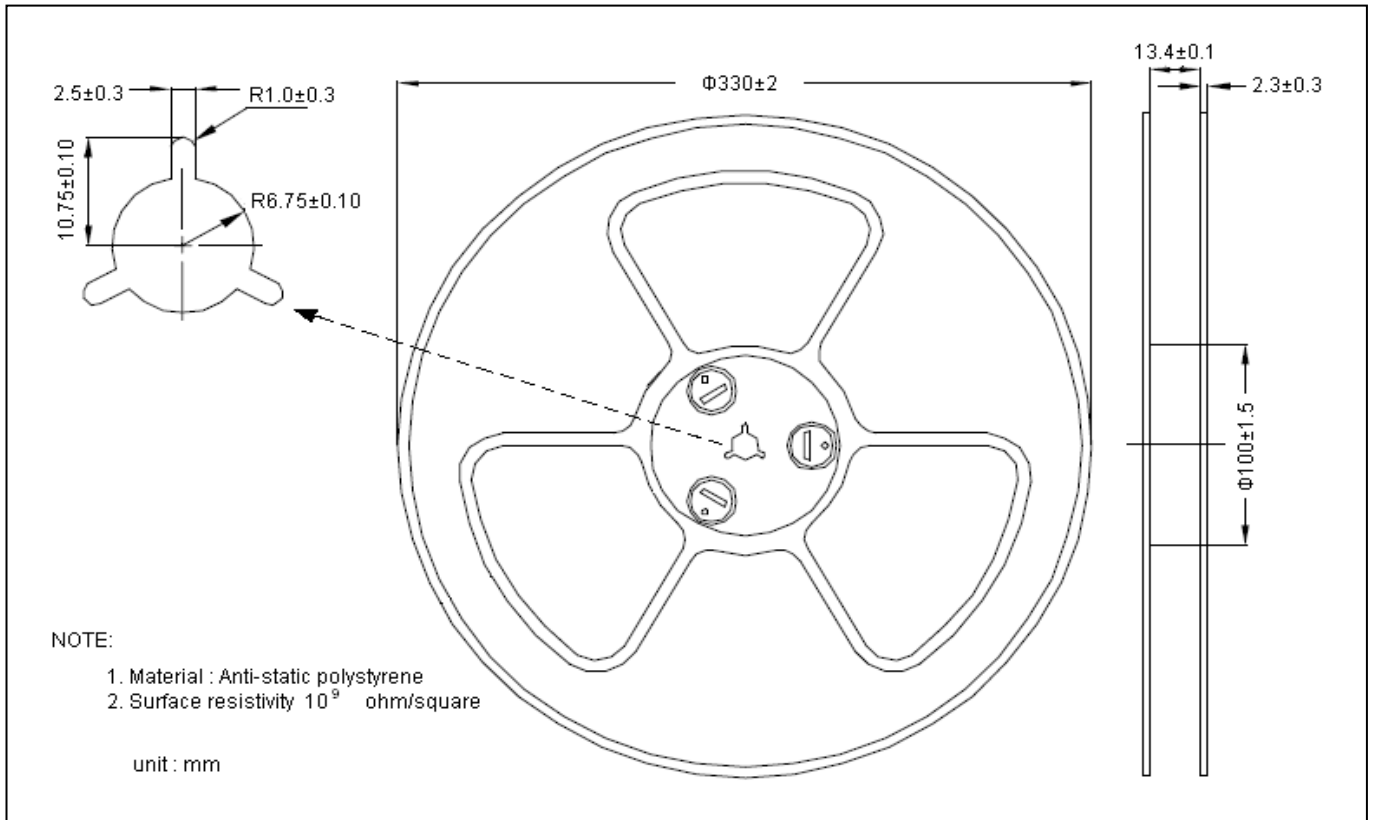

Carrier Tape Dimension

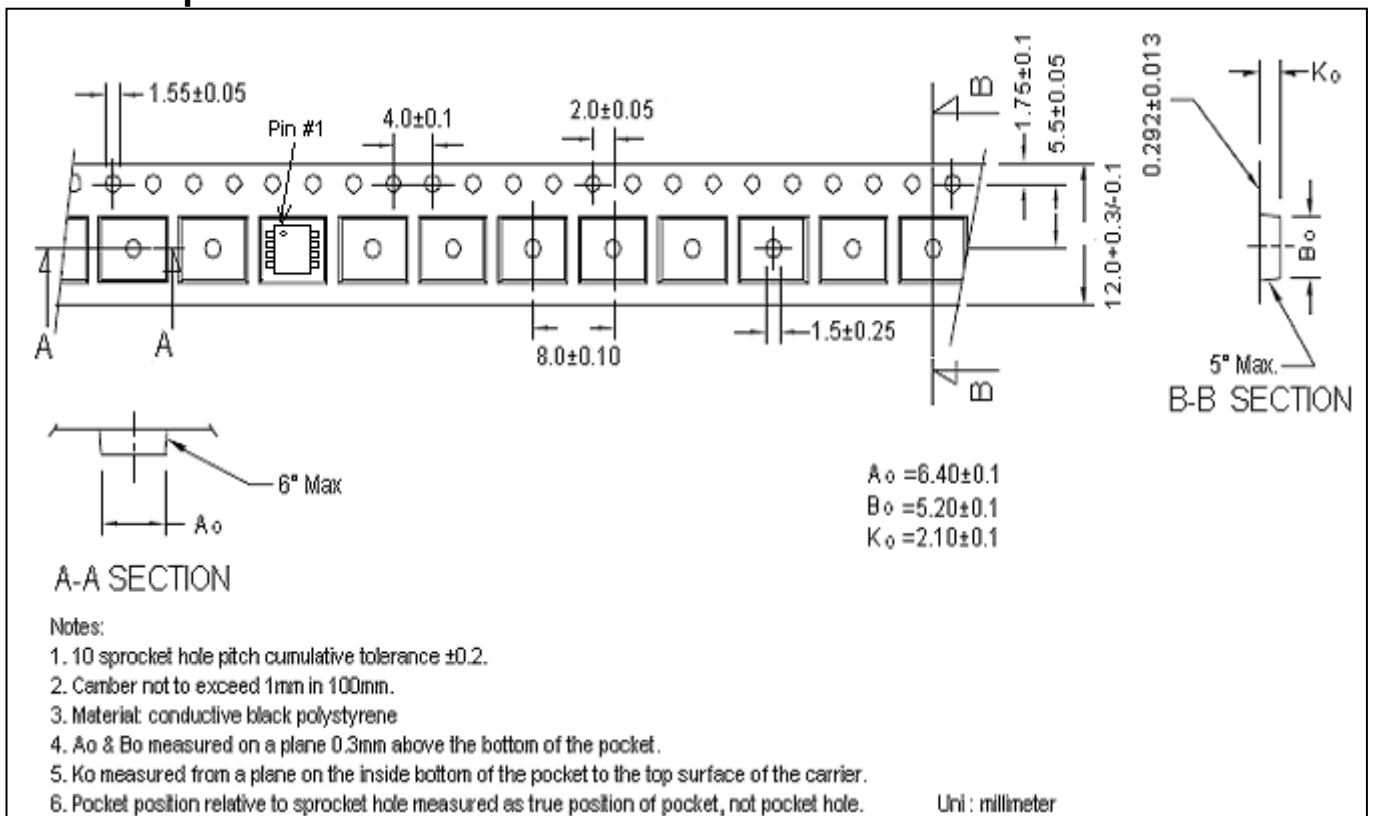

Recommended wave soldering condition

Product	Peak Temperature	Soldering Time
Pb-free devices	260 +0/-5 °C	5 +1/-1 seconds

Recommended temperature profile for IR reflow

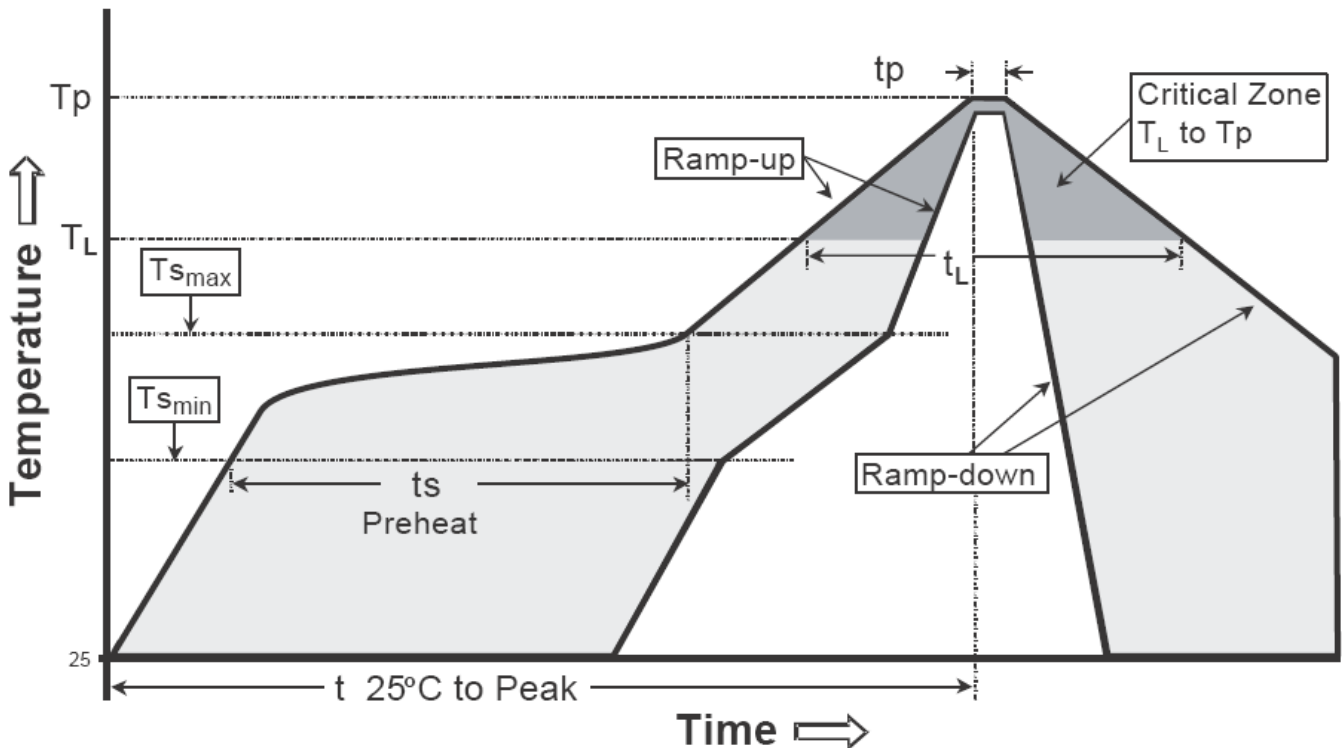

Profile feature	Sn-Pb eutectic Assembly	Pb-free Assembly
Average ramp-up rate (Tsmmax to Tp)	3°C/second max.	3°C/second max.
Preheat		
-Temperature Min(Ts min)	100°C	150°C
-Temperature Max(Ts max)	150°C	200°C
-Time(ts min to ts max)	60-120 seconds	60-180 seconds
Time maintained above:		
-Temperature (TL)	183°C	217°C
- Time (tL)	60-150 seconds	60-150 seconds
Peak Temperature(TP)	240 +0/-5 °C	260 +0/-5 °C
Time within 5°C of actual peak temperature(tp)	10-30 seconds	20-40 seconds
Ramp down rate	6°C/second max.	6°C/second max.
Time 25 °C to peak temperature	6 minutes max.	8 minutes max.

Note : All temperatures refer to topside of the package, measured on the package body surface.

SOP-8 Dimension

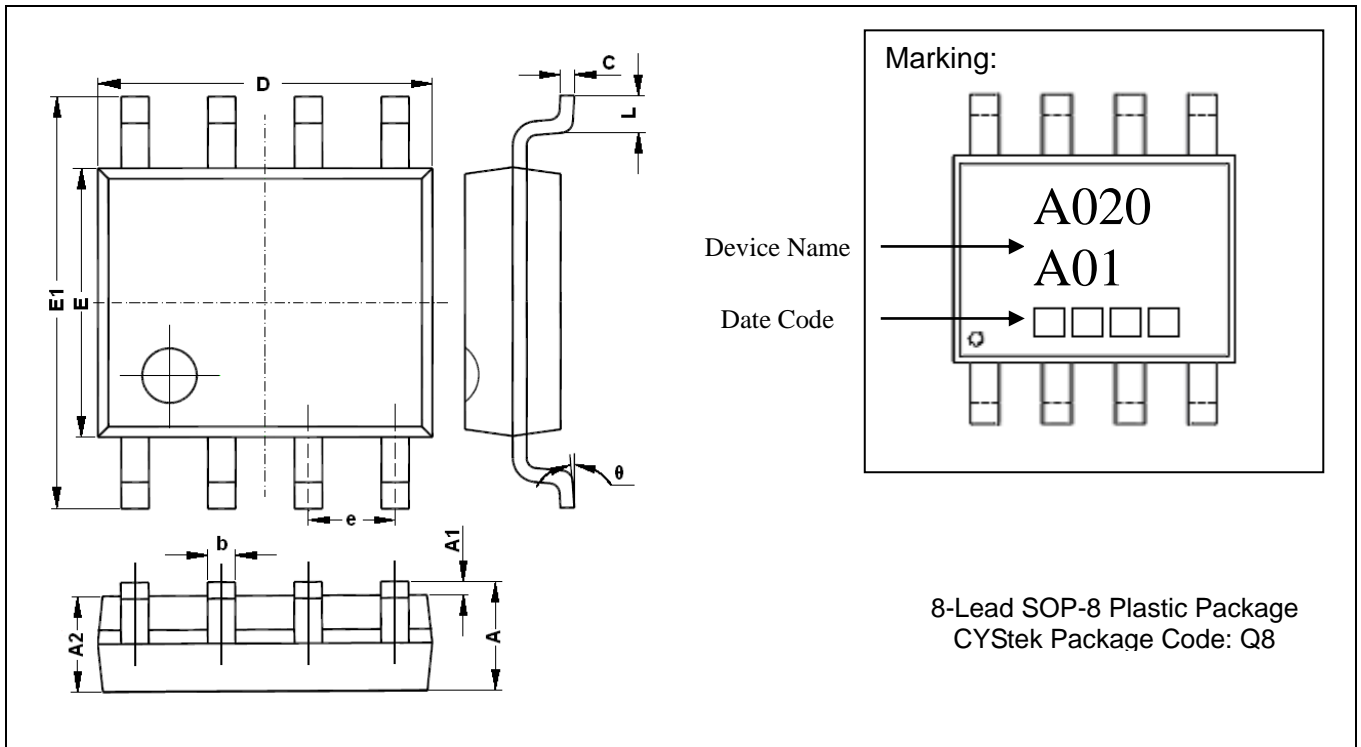

DIM	Millimeters		Inches		DIM	Millimeters		Inches	
	Min.	Max.	Min.	Max.		Min.	Max.	Min.	Max.
A	1.350	1.750	0.053	0.069	E	3.800	4.000	0.150	0.157
A1	0.100	0.250	0.004	0.010	E1	5.800	6.200	0.228	0.244
A2	1.350	1.550	0.053	0.061	e	1.270	(BSC)	0.050	(BSC)
b	0.330	0.510	0.013	0.020	L	0.400	1.270	0.016	0.050
c	0.170	0.250	0.006	0.010	θ	0	8°	0	8°
D	4.700	5.100	0.185	0.200					

Notes: 1.Controlling dimension: millimeters.
 2.Maximum lead thickness includes lead finish thickness, and minimum lead thickness is the minimum thickness of base material.
 3.If there is any question with packing specification or packing method, please contact your local CYStek sales office.

Material:

- Lead: Pure tin plated.
- Mold Compound: Epoxy resin family, flammability solid burning class: UL94V-0.

Important Notice:

- All rights are reserved. Reproduction in whole or in part is prohibited without the prior written approval of CYStek.
- CYStek reserves the right to make changes to its products without notice.
- CYStek **semiconductor products are not warranted to be suitable for use in Life-Support Applications, or systems.**
- CYStek assumes no liability for any consequence of customer product design, infringement of patents, or application assistance.