

**General Purpose NPN / PNP Epitaxial Planar Transistors
 (dual transistors)**

HBNP45S6R

Features

- Includes a BTC2412 chip and a BTA1037 chip in a SOT-363 package.
- Mounting possible with SOT-323 automatic mounting machines.
- Transistor elements are independent, eliminating interference.
- Mounting cost and area can be cut in half.
- Pb-free lead plating and halogen-free package.

Equivalent Circuit

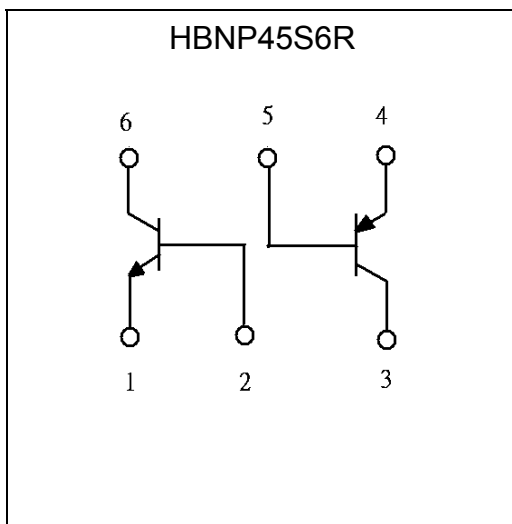

Outline

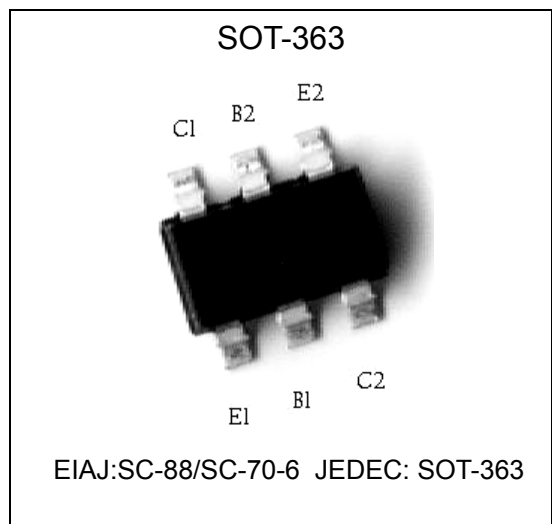

Ordering Information

Device	Package	Shipping
HBNP45S6R-0-T1-G	SOT-363 (Pb-free lead plating and halogen-free package)	3000 pcs / tape & reel

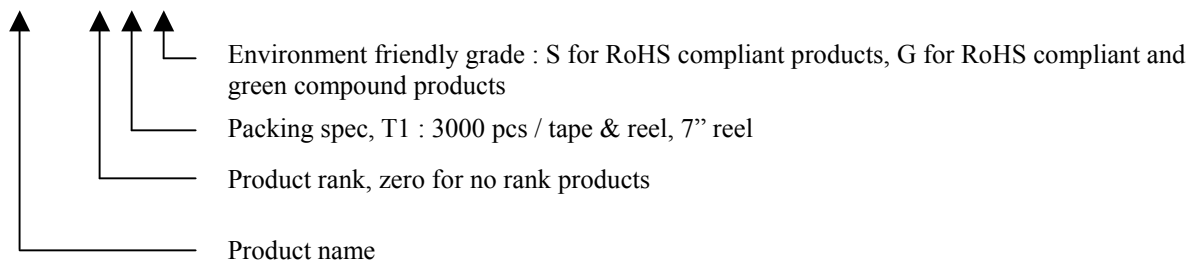



Absolute Maximum Ratings (Ta=25°C)

Parameter	Symbol	Limits		Unit
		TR1 (NPN)	TR2 (PNP)	
Collector-Base Voltage	V _{CB0}	60	-60	V
Collector-Emitter Voltage	V _{CEO}	50	-50	V
Emitter-Base Voltage	V _{EBO}	7	-6	V
Collector Current	I _C	150	-150	mA
Power Dissipation	P _d	200(total) *1		mW
Junction Temperature	T _j	150		°C
Storage Temperature	T _{stg}	-55~+150		°C

Note: *1 150mW per element must not be exceeded.

Characteristics (Ta=25°C)

• **TR1 (NPN)**

Symbol	Min.	Typ.	Max.	Unit	Test Conditions
BV _{CB0}	60	-	-	V	I _C =100μA
BV _{CEO}	50	-	-	V	I _C =1mA
BV _{EBO}	7	-	-	V	I _E =50μA
I _{CB0}	-	-	0.1	μA	V _{CB} =60V
I _{EBO}	-	-	0.1	μA	V _{EB} =7V
*V _{CE(sat)}	-	0.2	0.4	V	I _C =50mA, I _B =5mA
*h _{FE}	200	-	600		V _{CE} =6V, I _C =1mA
f _T	80	180	-	MHz	V _{CE} =12V, I _C =2mA, f=100MHz
C _{ob}	-	2	3.5	pF	V _{CB} =12V, f=1MHz

*Pulse Test: Pulse Width ≤380μs, Duty Cycle≤2%

• **TR2 (PNP)**

Symbol	Min.	Typ.	Max.	Unit	Test Conditions
BV _{CB0}	-60	-	-	V	I _C =-50μA
BV _{CEO}	-50	-	-	V	I _C =-1mA
BV _{EBO}	-6	-	-	V	I _E =-50μA
I _{CB0}	-	-	-0.1	μA	V _{CB} =-60V
I _{EBO}	-	-	-0.1	μA	V _{EB} =-6V
*V _{CE(sat)}	-	-0.25	-0.5	V	I _C =-50mA, I _B =-5mA
*h _{FE}	200	-	600		V _{CE} =-6V, I _C =-1mA
f _T	60	140	-	MHz	V _{CE} =-12V, I _C =-2mA, f=100MHz
C _{ob}	-	4	5	pF	V _{CB} =-12V, f=1MHz

*Pulse Test: Pulse Width ≤380μs, Duty Cycle≤2%

Characteristic curves

• TR1 (NPN)

Current Gain vs Collector Current

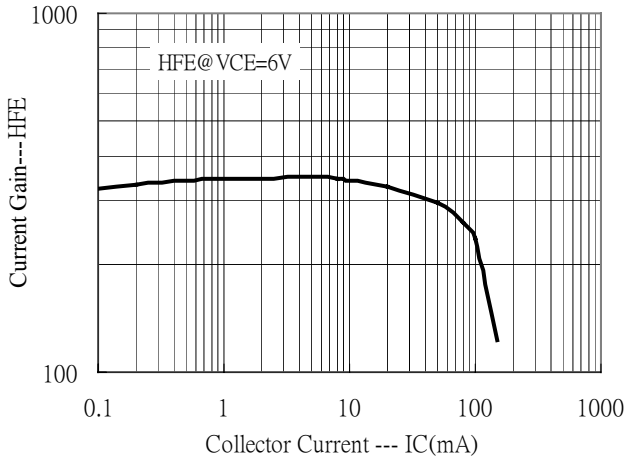

Saturation Voltage vs Collector Current

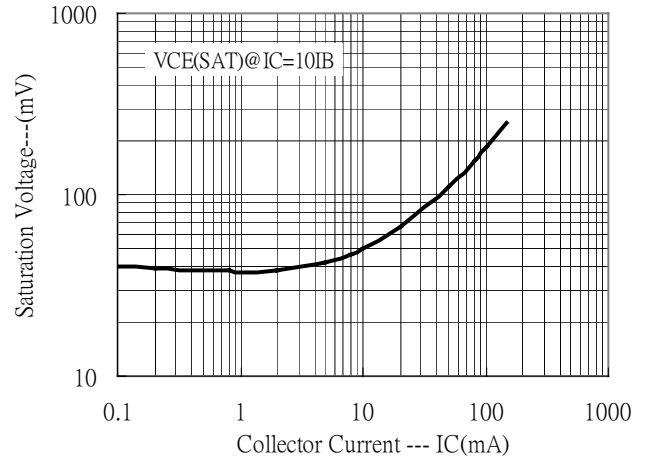

Saturation Voltage vs Collector Current

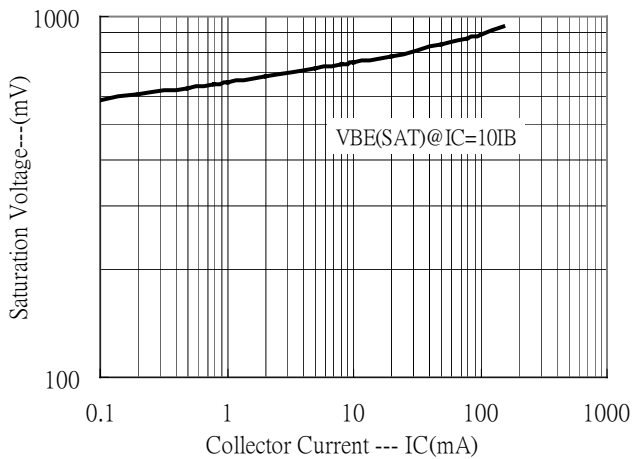

Cutoff Frequency vs Collector Current

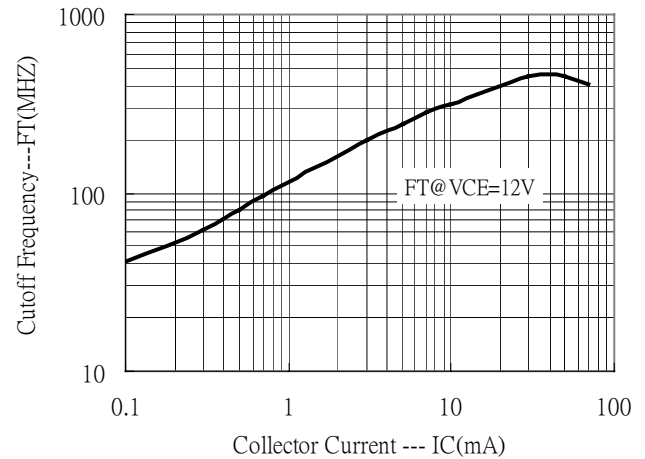

Capacitance Characteristics

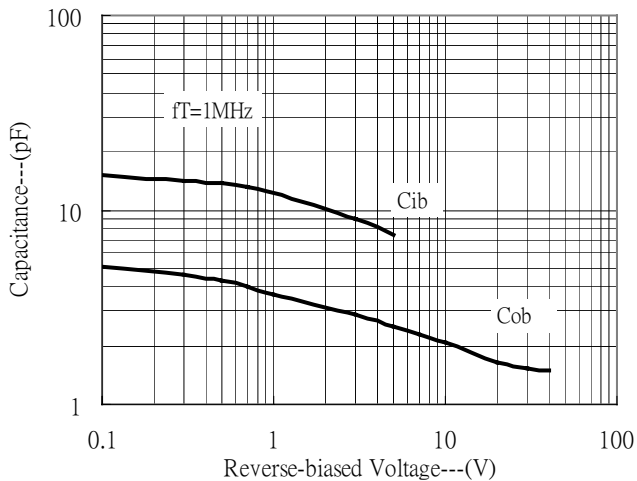



• TR2 (PNP)

Current Gain vs Collector Current

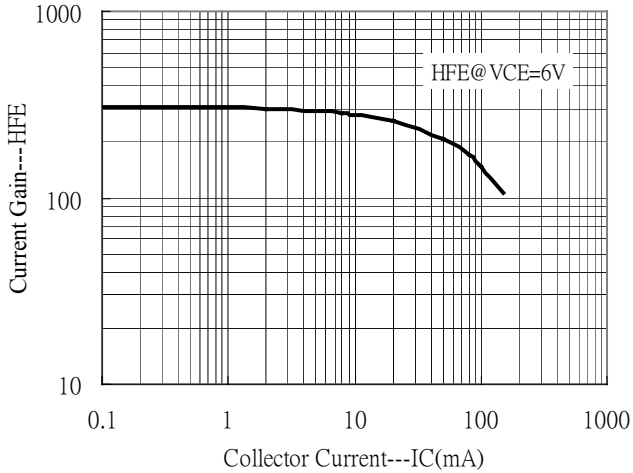

Saturation Voltage vs Collector Current

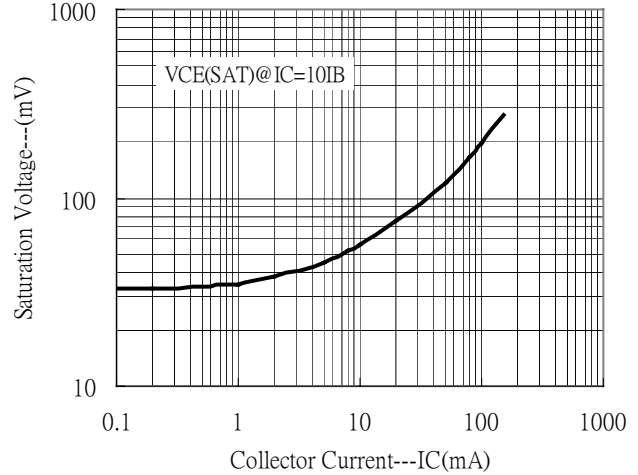

Saturation Voltage vs Collector Current

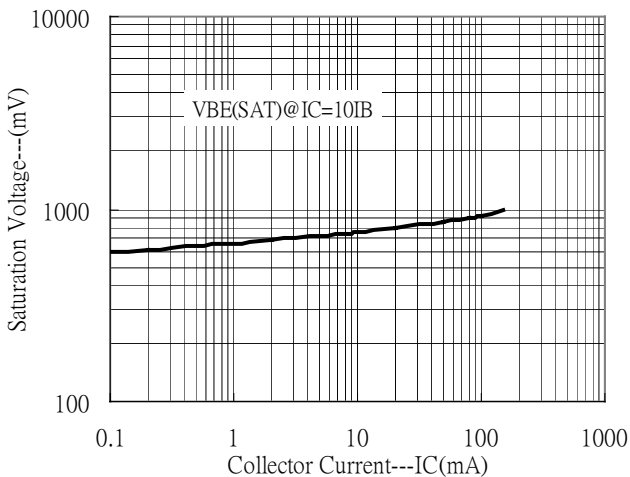

Cutoff Frequency vs Collector Current

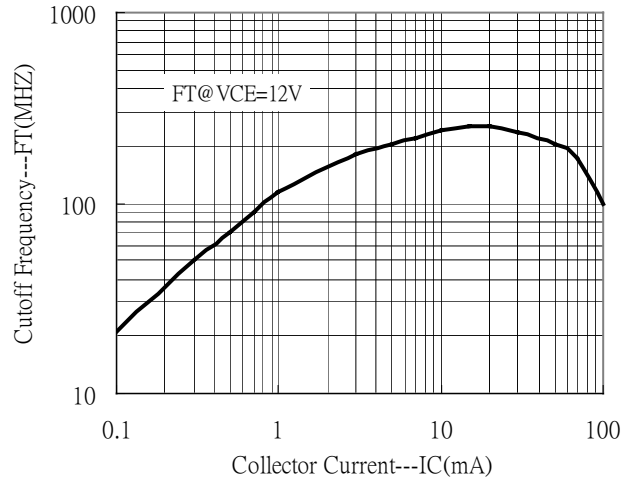

Capacitance Characteristics

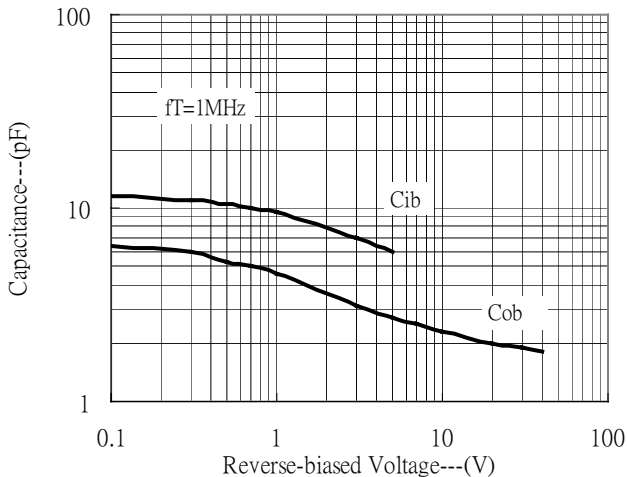

Power Derating Curves

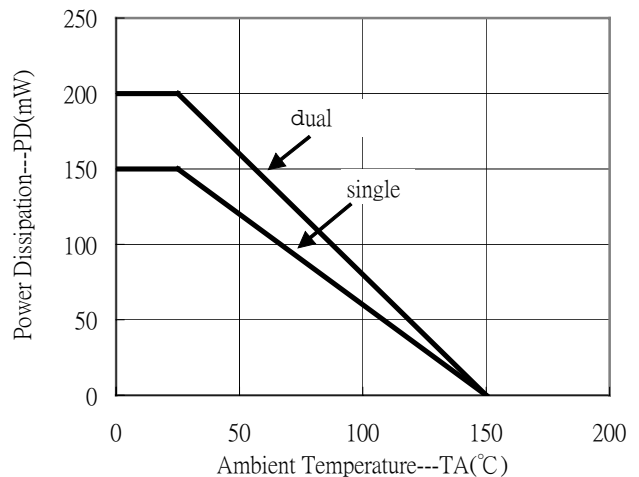

Reel Dimension

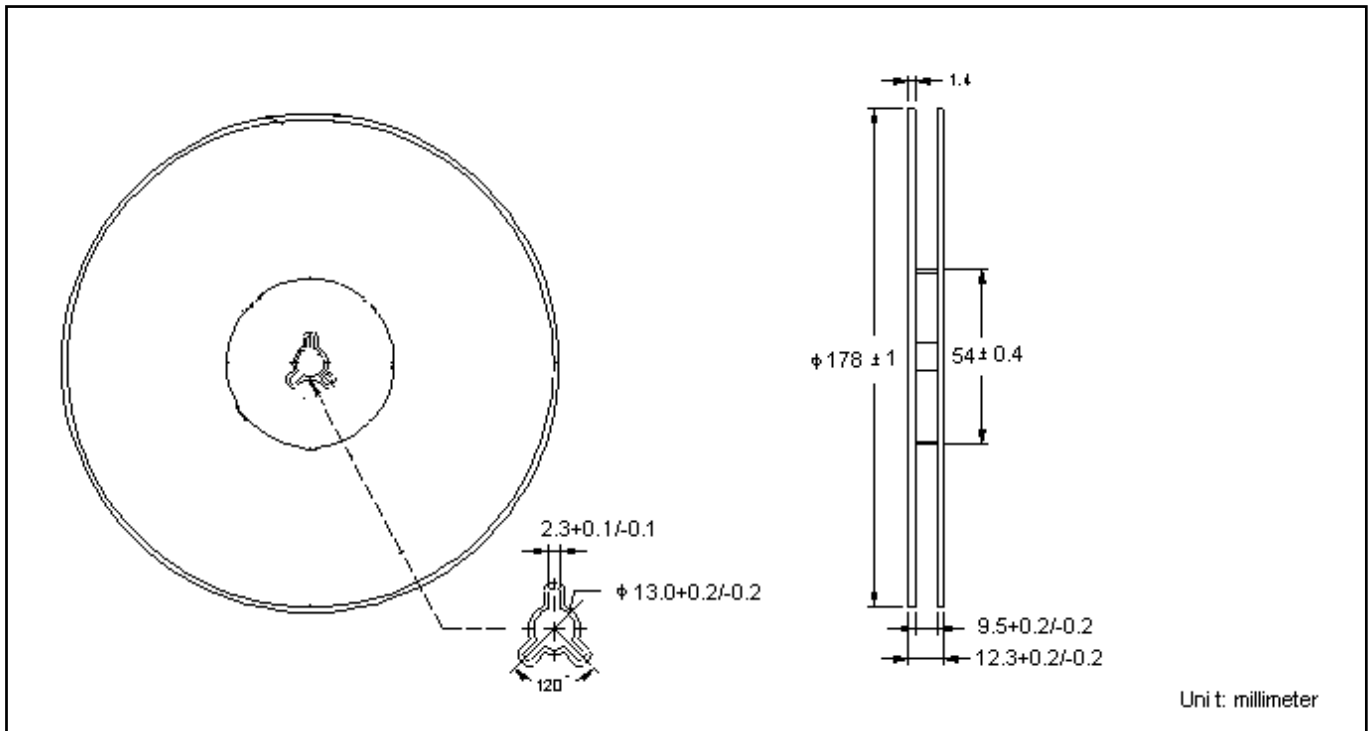

Carrier Tape Dimension

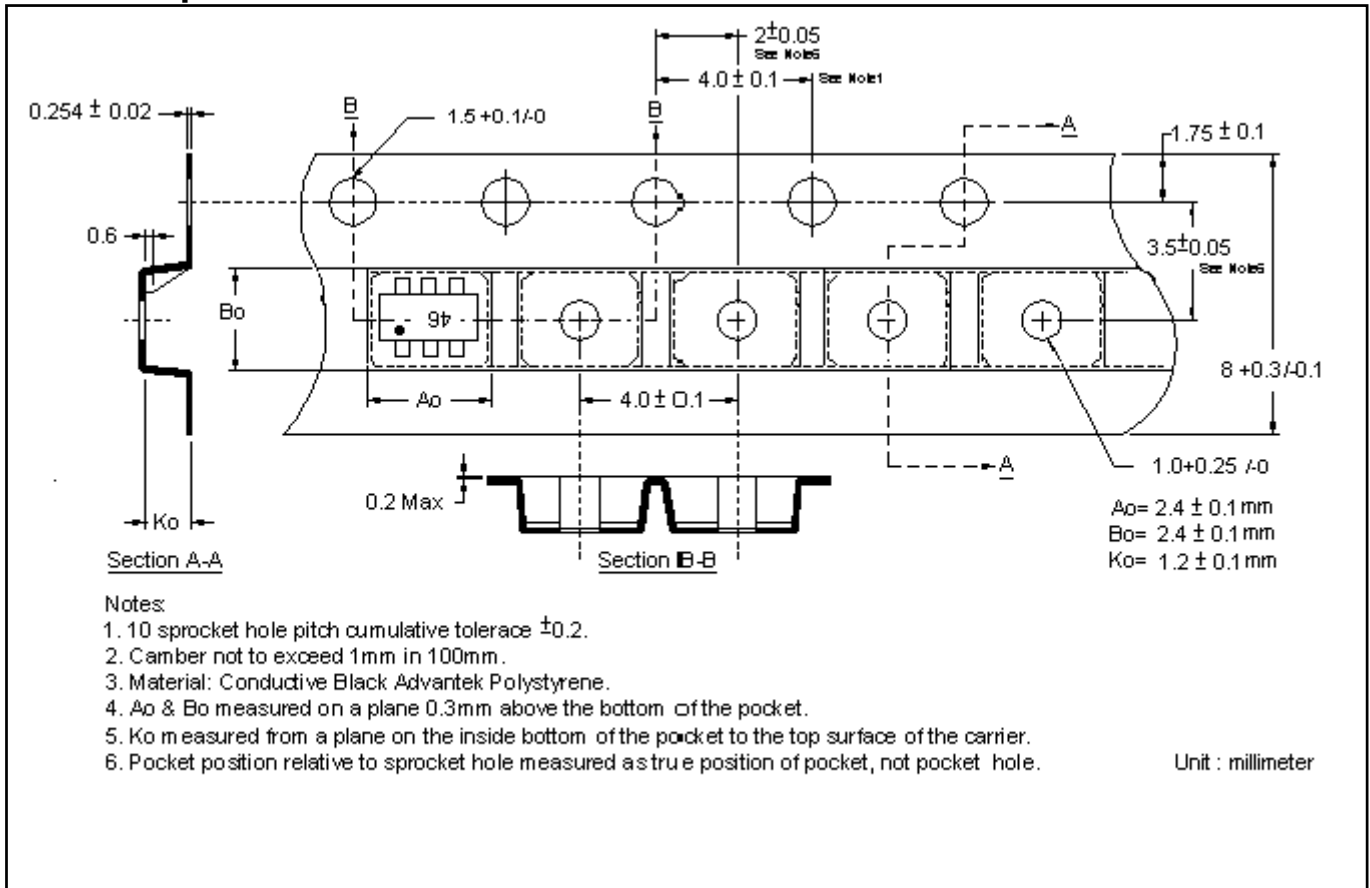

Recommended wave soldering condition

Product	Peak Temperature	Soldering Time
Pb-free devices	260 +0/-5 °C	5 +1/-1 seconds

Recommended temperature profile for IR reflow

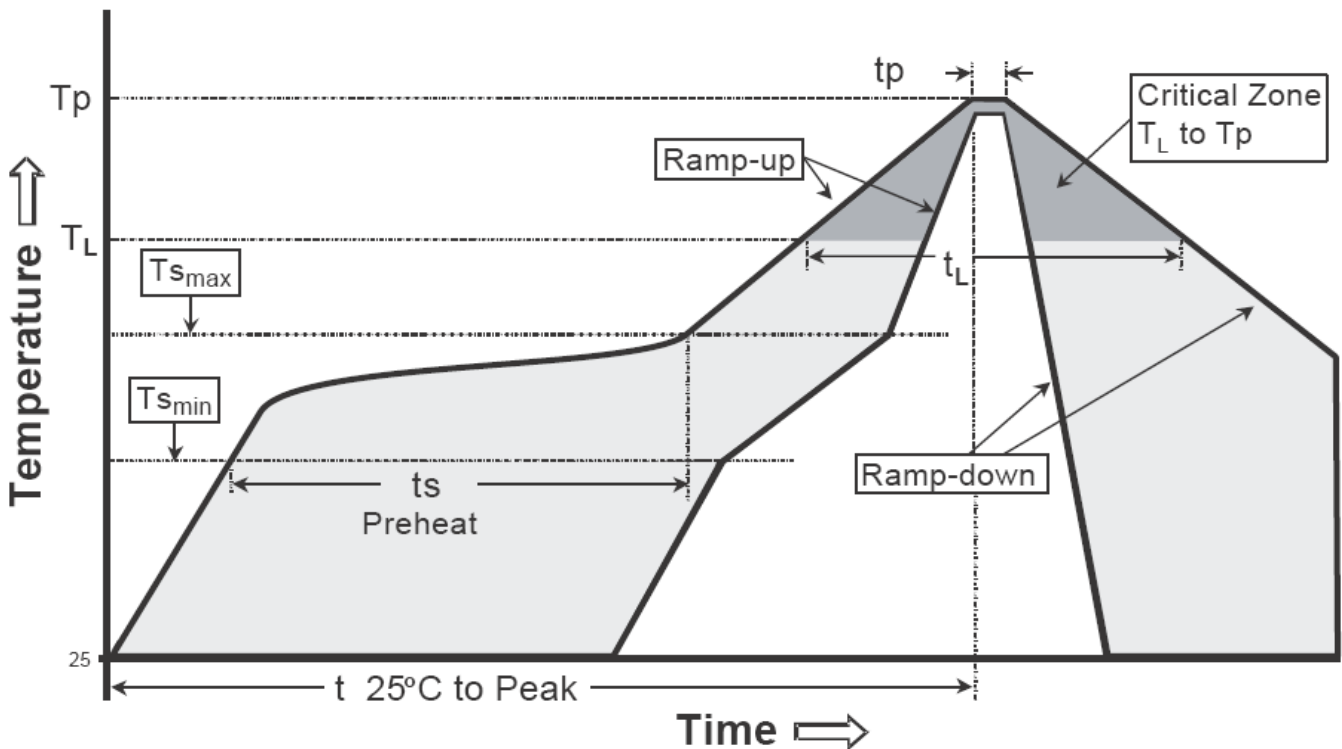

Profile feature	Sn-Pb eutectic Assembly	Pb-free Assembly
Average ramp-up rate (Tsmax to Tp)	3°C/second max.	3°C/second max.
Preheat		
-Temperature Min(Ts min)	100°C	150°C
-Temperature Max(Ts max)	150°C	200°C
-Time(ts min to ts max)	60-120 seconds	60-180 seconds
Time maintained above:		
-Temperature (T _L)	183°C	217°C
- Time (t _L)	60-150 seconds	60-150 seconds
Peak Temperature(T _P)	240 +0/-5 °C	260 +0/-5 °C
Time within 5°C of actual peak temperature(tp)	10-30 seconds	20-40 seconds
Ramp down rate	6°C/second max.	6°C/second max.
Time 25 °C to peak temperature	6 minutes max.	8 minutes max.

SOT-363 Dimension

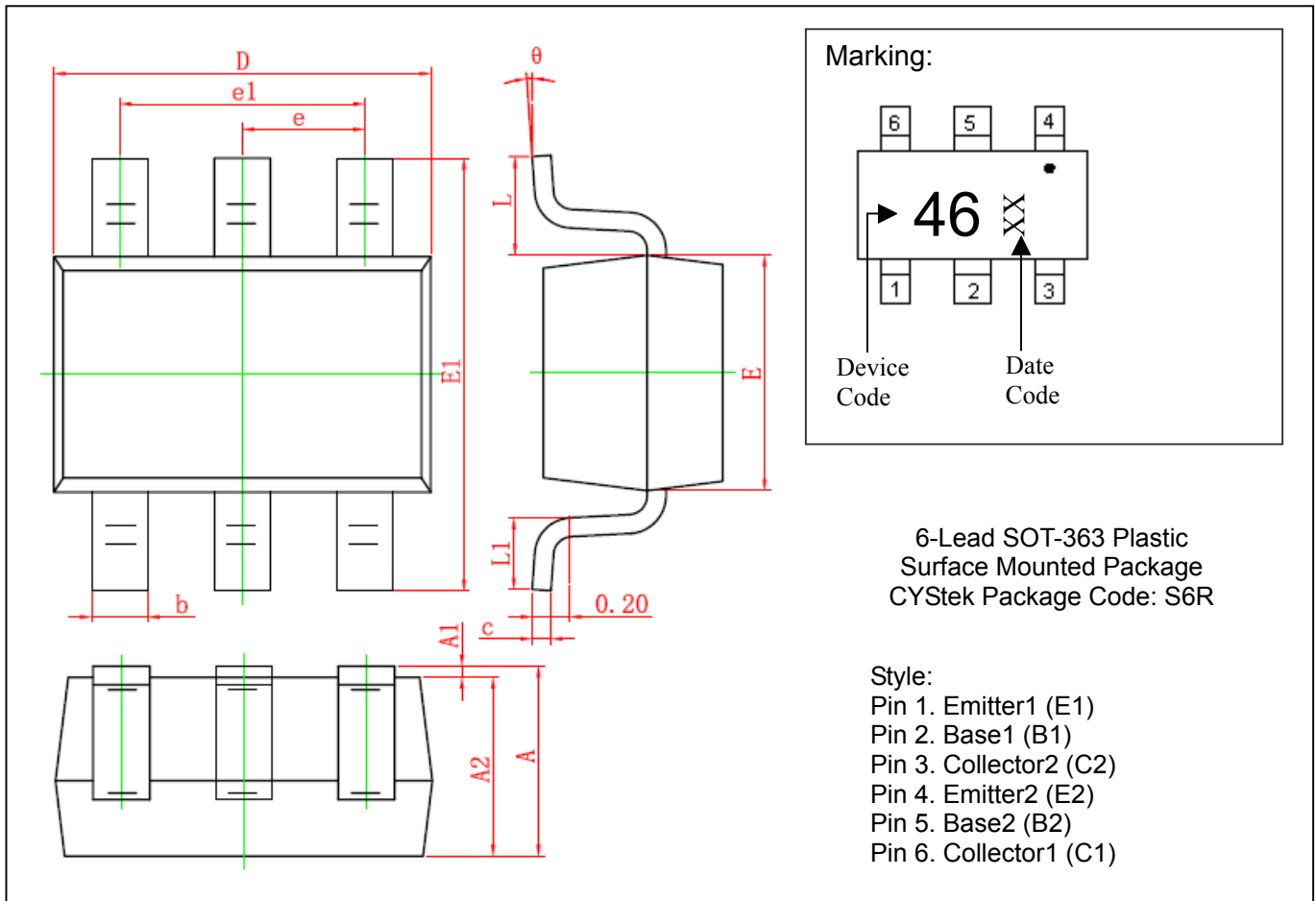

DIM	Millimeters		Inches		DIM	Millimeters		Inches	
	Min.	Max.	Min.	Max.		Min.	Max.	Min.	Max.
A	0.900	1.100	0.035	0.043	E1	2.150	2.450	0.085	0.096
A1	0.000	0.100	0.000	0.004	e	0.650 TYP		0.026 TYP	
A2	0.900	1.000	0.035	0.039	e1	1.200	1.400	0.047	0.055
b	0.150	0.350	0.006	0.014	L	0.525 REF		0.021 REF	
c	0.080	0.150	0.003	0.006	L1	0.260	0.460	0.010	0.018
D	2.000	2.200	0.079	0.087	θ	0°	8°	0°	8°
E	1.150	1.350	0.045	0.053					

Notes : 1. Controlling dimension : millimeters.
 2. Maximum lead thickness includes lead finish thickness, and minimum lead thickness is the minimum thickness of base material.
 3. If there is any question with packing specification or packing method, please contact your local CYStek sales office.

Material :

- Lead : Pure tin plated.
- Mold Compound : Epoxy resin family, flammability solid burning class:UL94V-0.

Important Notice:

- All rights are reserved. Reproduction in whole or in part is prohibited without the prior written approval of CYStek.
- CYStek reserves the right to make changes to its products without notice.
- CYStek **semiconductor products are not warranted to be suitable for use in Life-Support Applications, or systems.**
- CYStek assumes no liability for any consequence of customer product design, infringement of patents, or application assistance.