

**Switching Diode**

# DAN202C3

**Features**

- Fast switching speed.
- Ultra small surface mount package
- High conductance
- Pb-free package

**Equivalent Circuit**

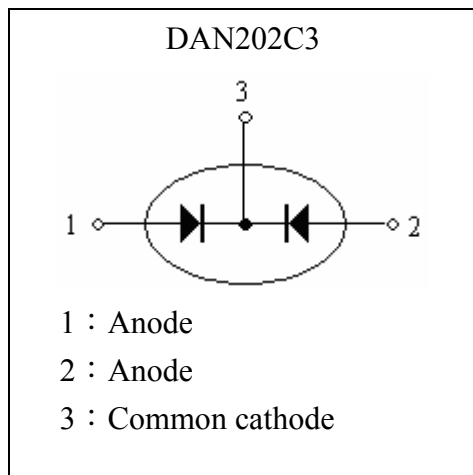

**Outline**

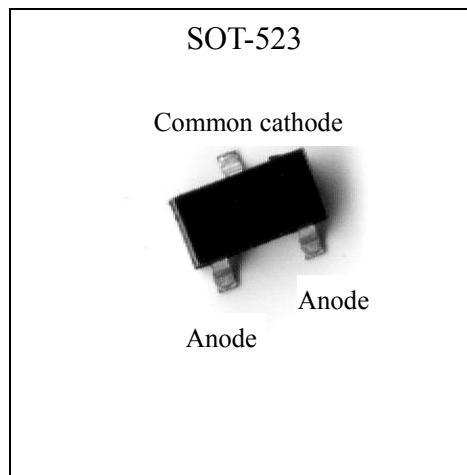

**Applications**

- For general purpose switching applications.

**Ordering Information**

Device	Package	Shipping	Marking
DAN202C3	SOT-523 (Pb-free)	3000 pcs / Tape & Reel	N



**Absolute Maximum Ratings @TA=25°C**

Parameters	Symbol	Min	Max	Unit
Repetitive peak reverse voltage	$V_{RRM}$	-	110	V
Continuous reverse voltage	$V_R$	-	100	V
Average Rectified Forward Current (single)	$I_O$	-	150	mA
Repetitive peak forward current	$I_{FM}$		300	mA
Non-repetitive peak forward current @square wave, $T_j=125^\circ\text{C}$ prior to surge	$I_{FSM}$	$t=1\mu\text{s}$	4	A
$t=1\text{ms}$		1	A	
$t=1\text{s}$		0.5	A	
Power Dissipation(Note 1)	$P_D$		150	mW
Operating Junction Temperature Range	$T_j$	-55	+150	°C
Storage Temperature Range	$T_{stg}$	-65	+150	°C

Note 1: Device mounted on an FR-4 PCB.

**Electrical Characteristics @ Ta=25°C unless otherwise specified**

Parameters	Symbol	Conditions	Min	Typ.	Max	Unit
Reverse Breakdown Voltage	$V_{R(BR)}$	$I_R=100\mu\text{A}$	100	-	-	V
Forward voltage	$V_F$	$I_F=1\text{mA}$			715	mV
		$I_F=10\text{mA}$			855	mV
		$I_F=50\text{mA}$			1	V
		$I_F=150\text{mA}$			1.25	V
Reverse current	$I_R$	$V_R=25\text{V}$			30	nA
		$V_R=100\text{V}$			2.5	$\mu\text{A}$
Diode capacitance	$C_d$	$V_R=0\text{V}, f=1\text{MHz}$			2	pF
Reverse recovery time	$t_{rr}$	when switched from $I_F=10\text{mA}$ to $I_R=10\text{mA}, R_L=100\Omega$ , measured at $I_R=1\text{mA}$			4	ns

**Thermal Characteristics**

Symbol	Parameter	Conditions	Value	Unit
$R_{th, j-a}$	thermal resistance from junction to ambient	Note 1	833	°C/W

Note 1: Device mounted on an FR-4 PCB.



### Typical Characteristics

Power Derating Curve

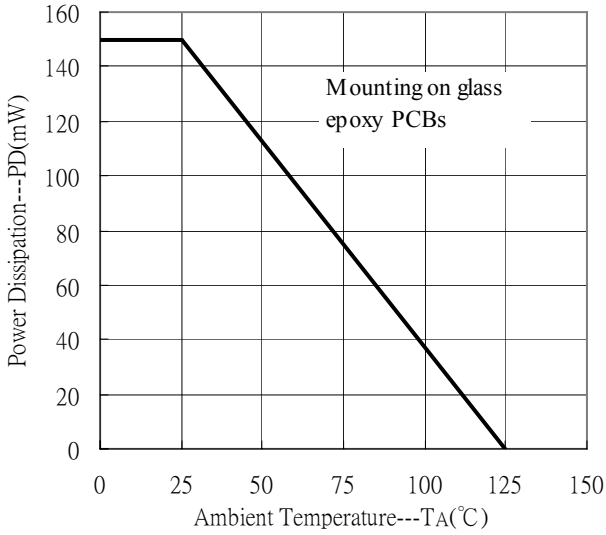

Forward Current vs Forward Voltage

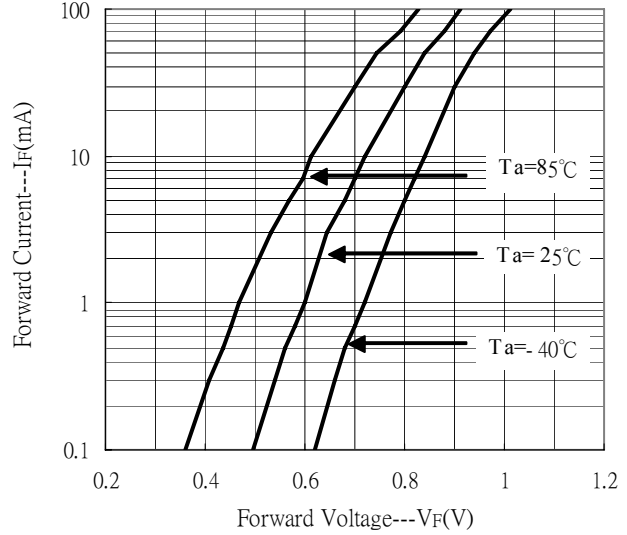

Reverse Leakage Current vs Reverse Voltage

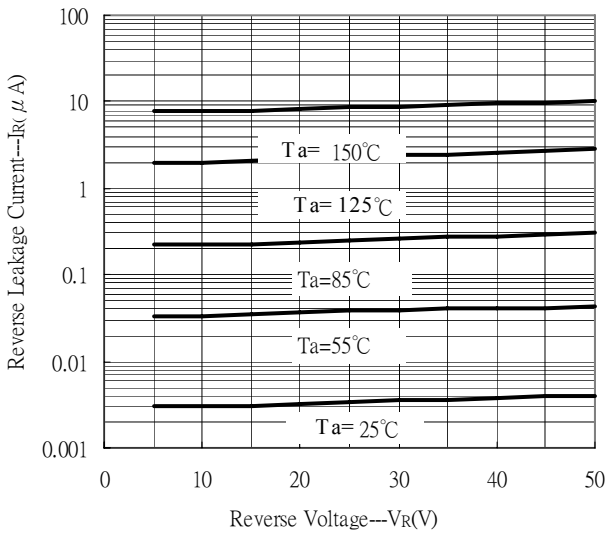

Capacitance vs Reverse Voltage

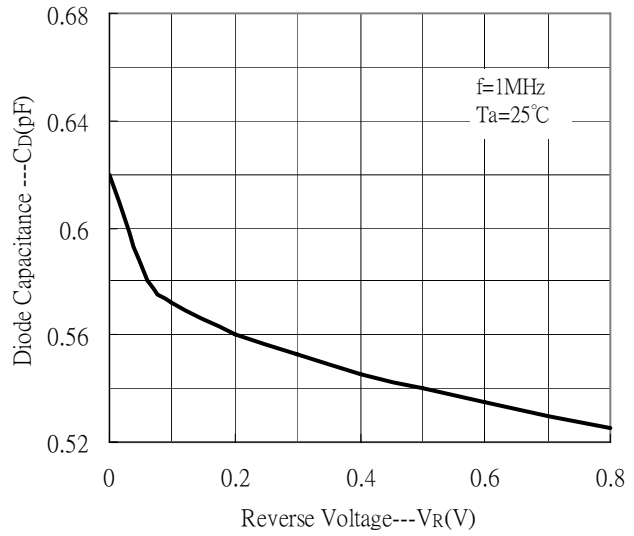

**Reel Dimension**

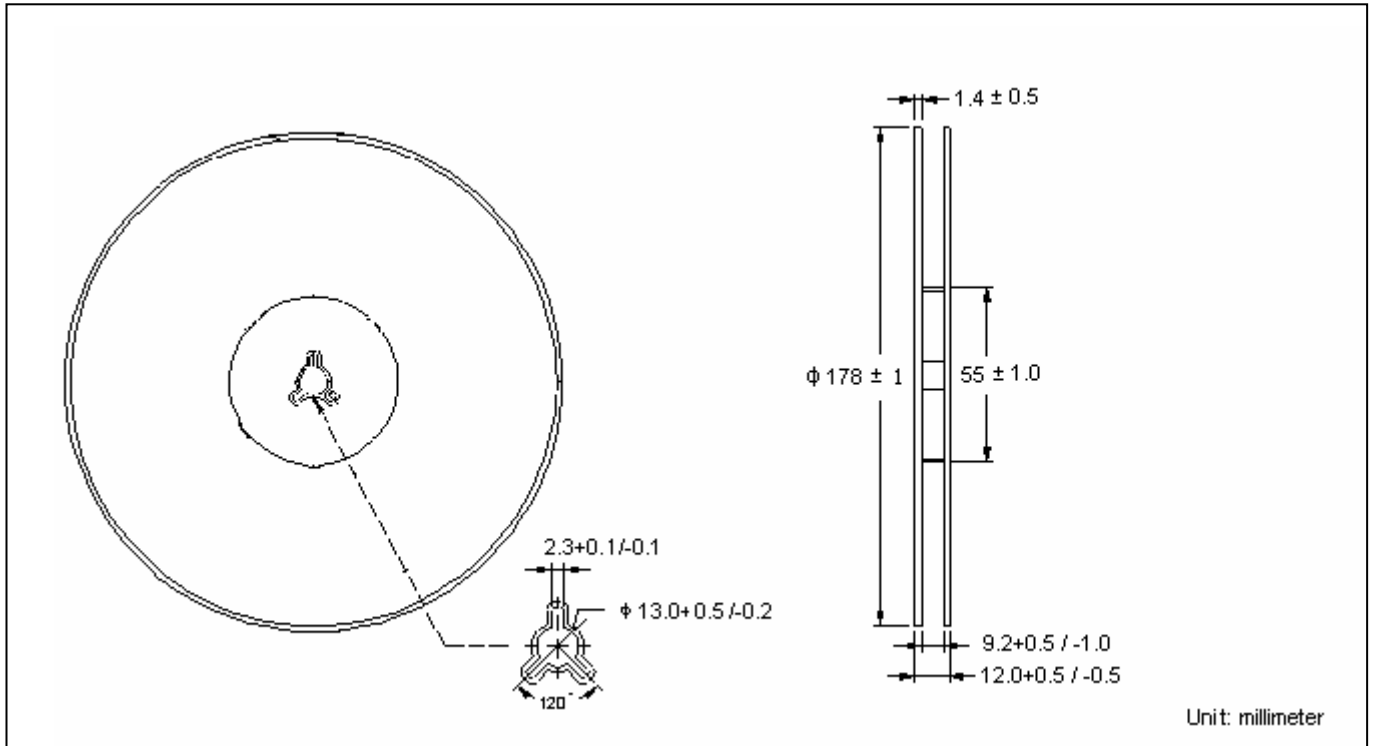

**Carrier Tape Dimension**

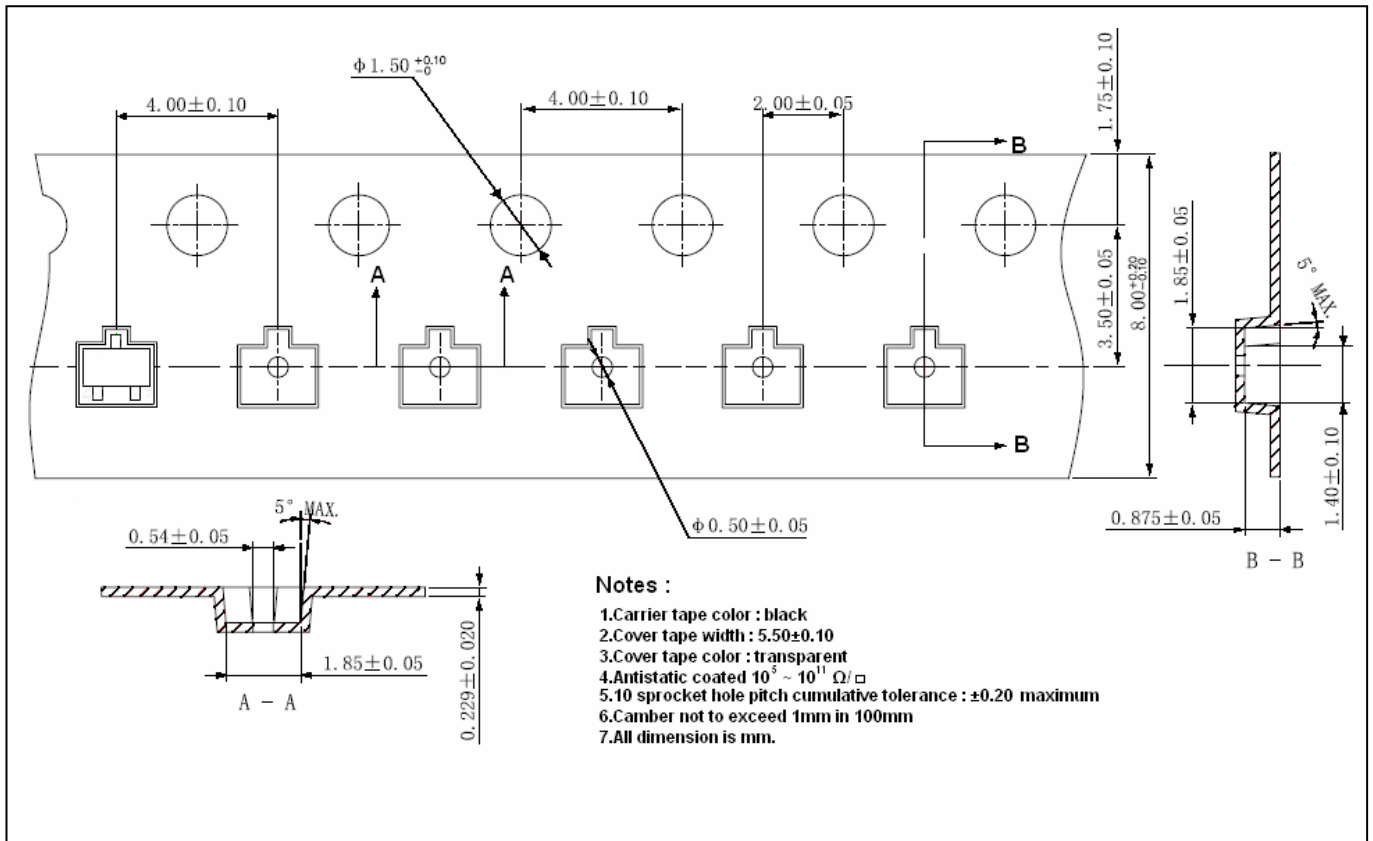

**Recommended wave soldering condition**

Product	Peak Temperature	Soldering Time
Pb-free devices	260 +0/-5 °C	5 +1/-1 seconds

**Recommended temperature profile for IR reflow**

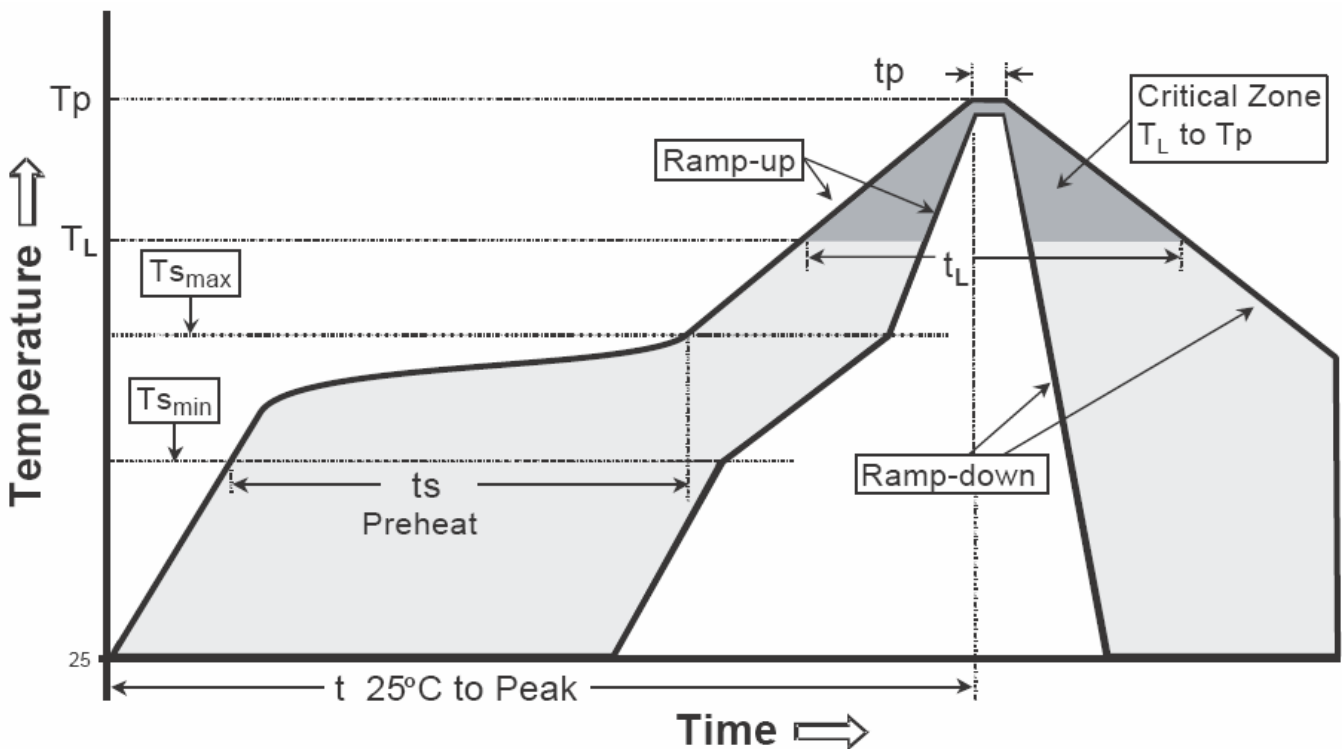

Profile feature	Sn-Pb eutectic Assembly	Pb-free Assembly
Average ramp-up rate (T <sub>smax</sub> to T <sub>p</sub> )	3°C/second max.	3°C/second max.
Preheat		
-Temperature Min(T <sub>s min</sub> )	100°C	150°C
-Temperature Max(T <sub>s max</sub> )	150°C	200°C
-Time(t <sub>s min</sub> to t <sub>s max</sub> )	60-120 seconds	60-180 seconds
Time maintained above:		
-Temperature (T <sub>L</sub> )	183°C	217°C
- Time (t <sub>L</sub> )	60-150 seconds	60-150 seconds
Peak Temperature(T <sub>P</sub> )	240 +0/-5 °C	260 +0/-5 °C
Time within 5°C of actual peak temperature(tp)	10-30 seconds	20-40 seconds
Ramp down rate	6°C/second max.	6°C/second max.
Time 25 °C to peak temperature	6 minutes max.	8 minutes max.

Note : All temperatures refer to topside of the package, measured on the package body surface.

**SOT-523 Dimension (C Forming)**

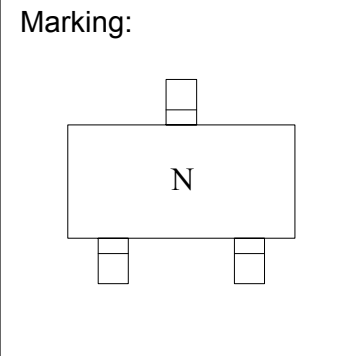
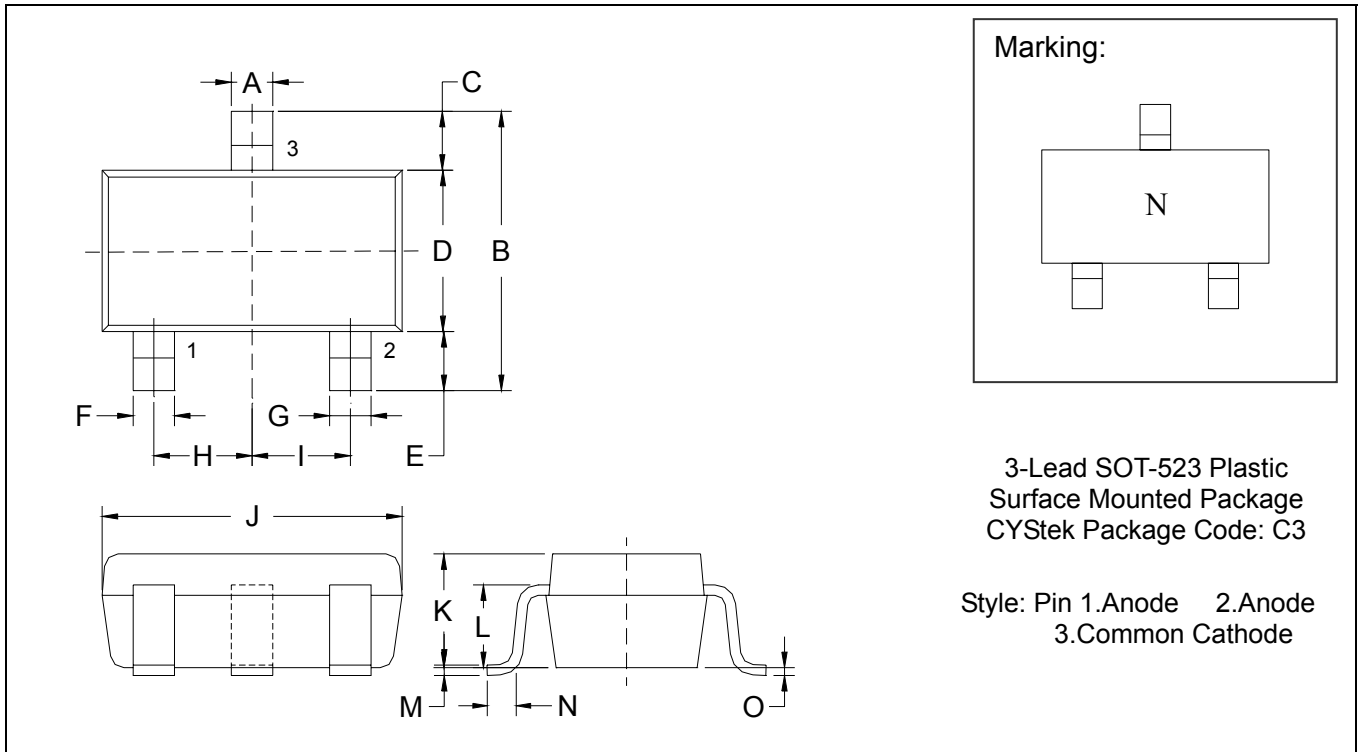

3-Lead SOT-523 Plastic  
 Surface Mounted Package  
 CYStek Package Code: C3

Style: Pin 1.Anode 2.Anode  
 3.Common Cathode

\*: Typical

DIM	Inches		Millimeters		DIM	Inches		Millimeters	
	Min.	Max.	Min.	Max.		Min.	Max.	Min.	Max.
A	0.0079	0.0157	0.20	0.40	I	*0.0197	-	*0.50	-
B	0.0591	0.0669	1.50	1.70	J	0.0610	0.0650	1.55	1.65
C	0.0118	0.0197	0.30	0.50	K	0.0276	0.0315	0.70	0.80
D	0.0295	0.0335	0.75	0.85	L	0.0224	0.0248	0.57	0.63
E	0.0118	0.0197	0.30	0.50	M	0.0020	0.0059	0.05	0.15
F	0.0039	0.0118	0.10	0.30	N	0.0039	0.0118	0.10	0.30
G	0.0039	0.0118	0.10	0.30	O	0	0.0031	0	0.08
H	*0.0197	-	*0.50	-					

Notes: 1.Controlling dimension: millimeters.  
 2.Maximum lead thickness includes lead finish thickness, and minimum lead thickness is the minimum thickness of base material.  
 3.If there is any question with packing specification or packing method, please contact your local CYStek sales office.

**Material:**

- Lead: Pure tin plated.
- Mold Compound: Epoxy resin family, flammability solid burning class: UL94V-0

**Important Notice:**

- All rights are reserved. Reproduction in whole or in part is prohibited without the prior written approval of CYStek.
- CYStek reserves the right to make changes to its products without notice.
- CYStek **semiconductor products are not warranted to be suitable for use in Life-Support Applications, or systems.**
- CYStek assumes no liability for any consequence of customer product design, infringement of patents, or application assistance.