

# 1.0Amp. Surface Mount Schottky Barrier Diodes

## CSOD5817-5819S2

### Features

- For surface mounted applications.
- For use in low voltage, high frequency inverters, free wheeling, and polarity protection applications
- Plastic material used carries Underwriters Laboratory Flammability Classification 94V-0
- Low leakage current
- High surge capability
- High temperature soldering: 250°C/10 seconds at terminals
- Exceeds environmental standards of MIL-S-19500/228
- RoHS compliant package

### Mechanical Data

- Case: Molded plastic, JEDEC SOD-323.
- Terminals: Pure tin plated, Solderable per MIL-STD-750 method 2026
- Polarity: Indicated by cathode band.
- Weight: 4.507 mg approximately

### Symbol

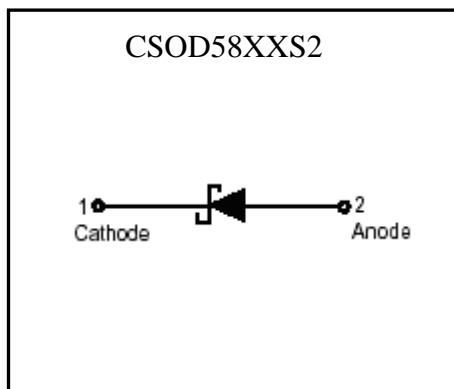

### Outline

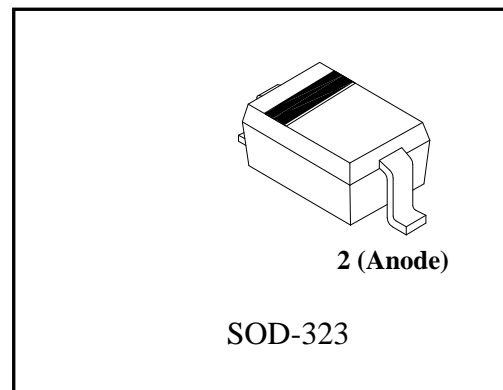

### Ordering Information

Device	Package	Shipping
CSOD58XXS2-0-T1-G	SOD-323 (Pb-free lead plating and halogen-free package)	3000 pcs / Tape & Reel

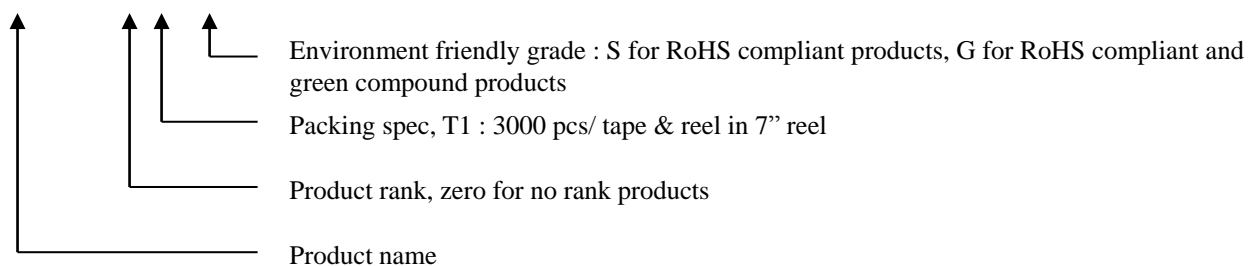

## Maximum Ratings and Electrical Characteristics

(Rating at 25°C ambient temperature unless otherwise specified. )

Parameter	Symbol	Type			Units
		5817	5818	5819	
Repetitive peak reverse voltage	V <sub>RRM</sub>	20	30	40	V
Maximum RMS voltage	V <sub>RMS</sub>	14	21	28	V
Maximum DC blocking voltage	V <sub>R</sub>	20	30	40	V
Maximum instantaneous forward voltage, I <sub>F</sub> =1A (Note 1)	V <sub>F</sub>	0.45	0.55	0.6	V
Average forward rectified current	I <sub>O</sub>	1			A
Peak forward surge current @8.3ms single half sine wave superimposed on rated load (JEDEC method)	I <sub>FSM</sub>	10			A
Maximum DC reverse current V <sub>R</sub> =V <sub>RRM</sub> , T <sub>J</sub> =25°C (Note 1)	I <sub>R</sub>	1			mA
Maximum thermal resistance, Junction to ambient	R <sub>th,JA</sub>	500(typ)			°C/W
Power Dissipation @ T <sub>A</sub> =25°C	P <sub>D</sub>	250			mW
Diode junction capacitance @ f=1MHz and applied 4V reverse voltage	C <sub>D</sub>	120 (max)			pF
Storage temperature range	T <sub>stg</sub>	-65 ~ +150			°C
Operating temperature range	T <sub>J</sub>	-50 ~ +150			°C

Notes : 1.Pulse test, pulse width=300 μ sec, 2% duty cycle

## Recommended Footprint

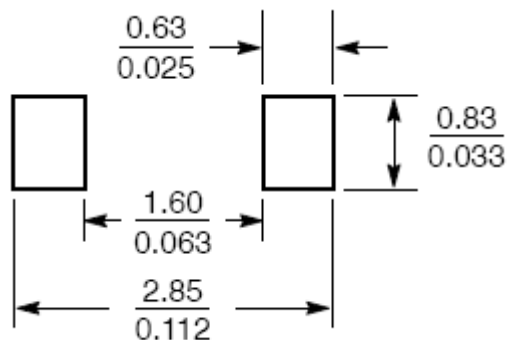

mm  
inch

## Characteristic Curves

**Fig. 1 - Forward Current Derating Curve**

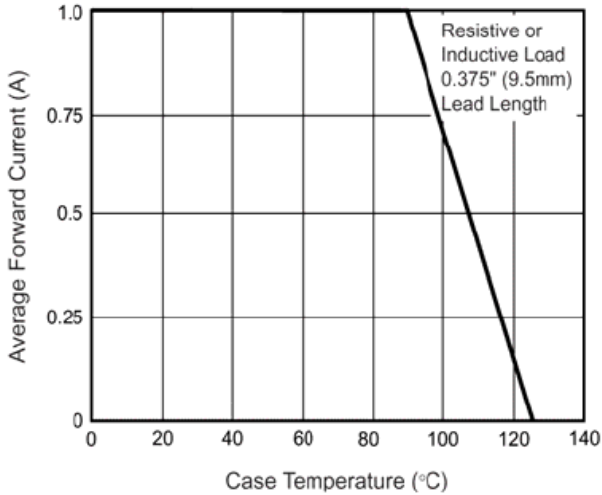

**Fig. 2 - Maximum Non-Repetitive Peak Forward Surge Current**

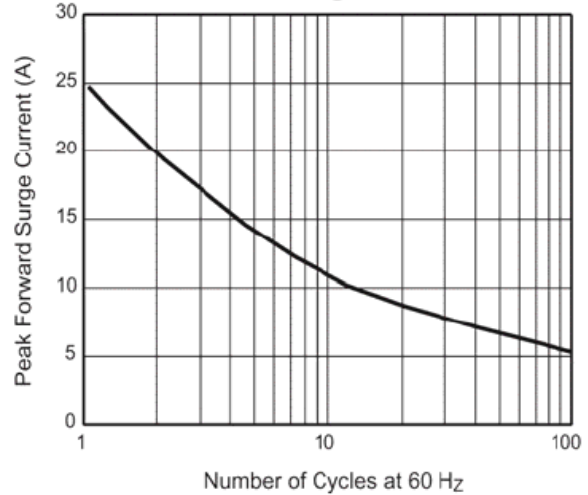

**Fig. 3 - Typical Instantaneous Forward Characteristics**

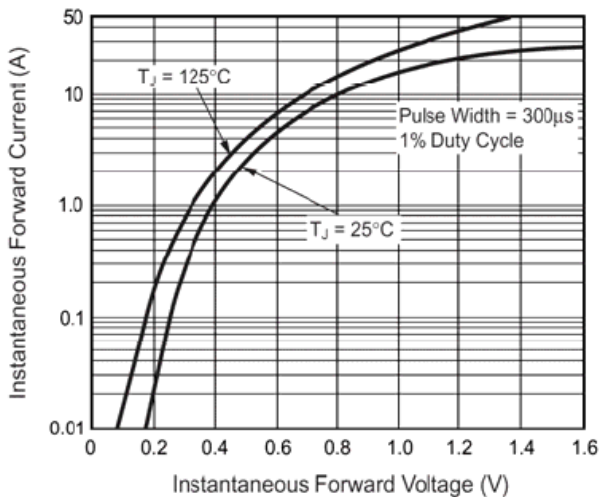

**Fig. 4 - Typical Reverse Characteristics**

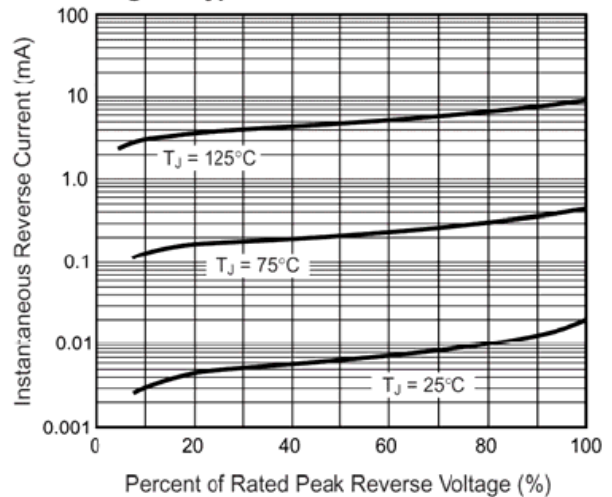

**Fig. 5 - Typical Junction Capacitance**

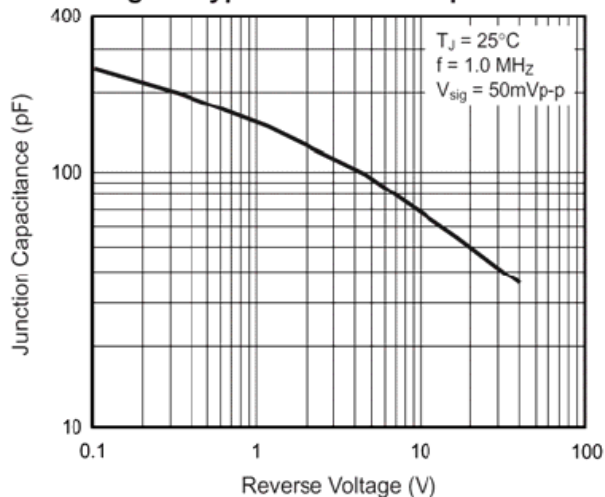

**Fig. 6 - Typical Transient Thermal Impedance**

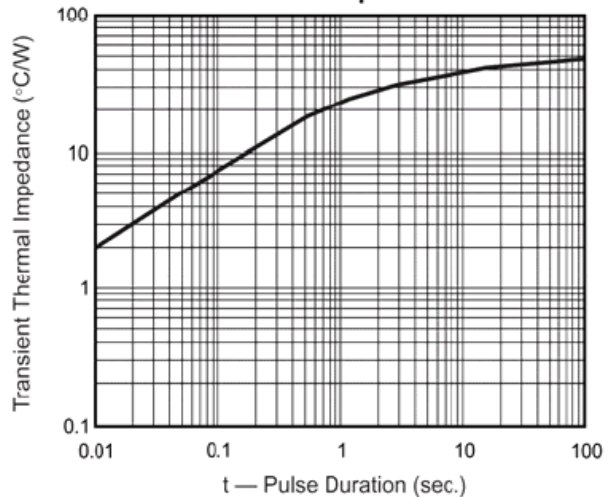

**Reel Dimension**

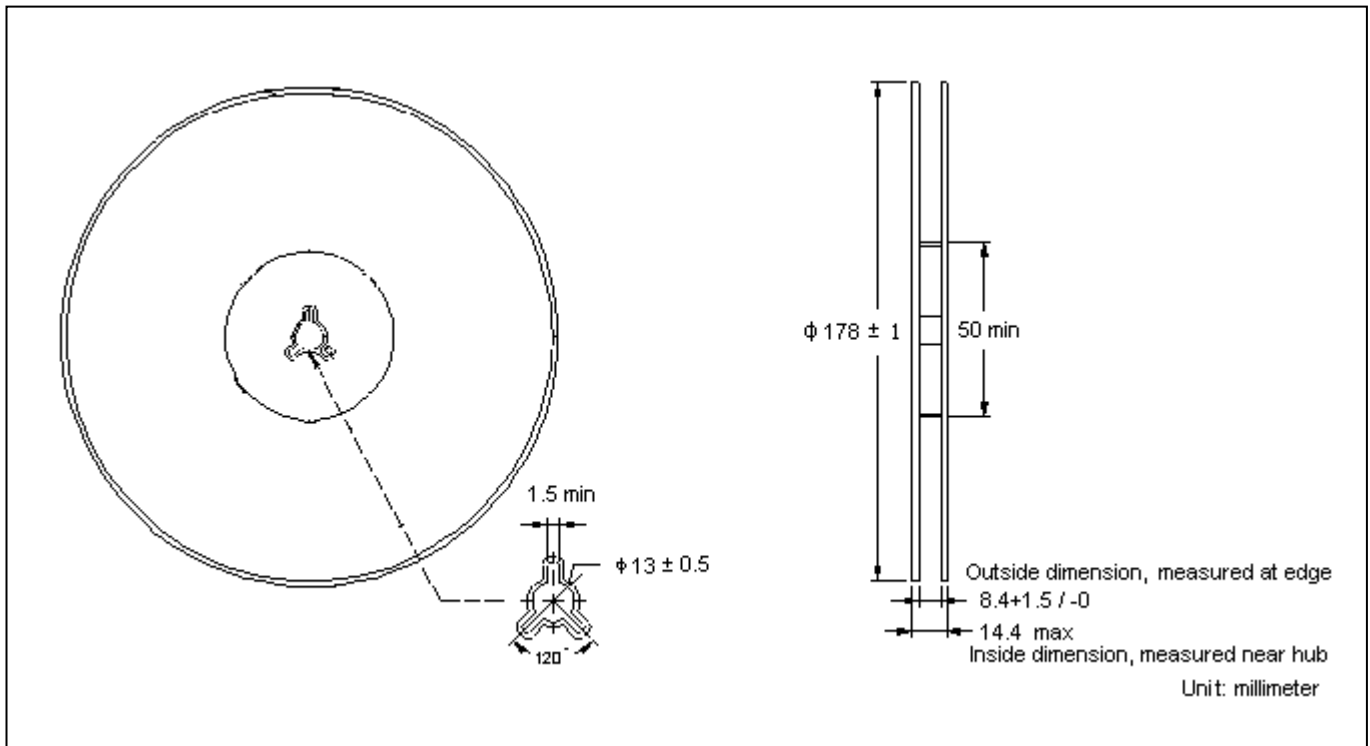

**Carrier Tape Dimension**

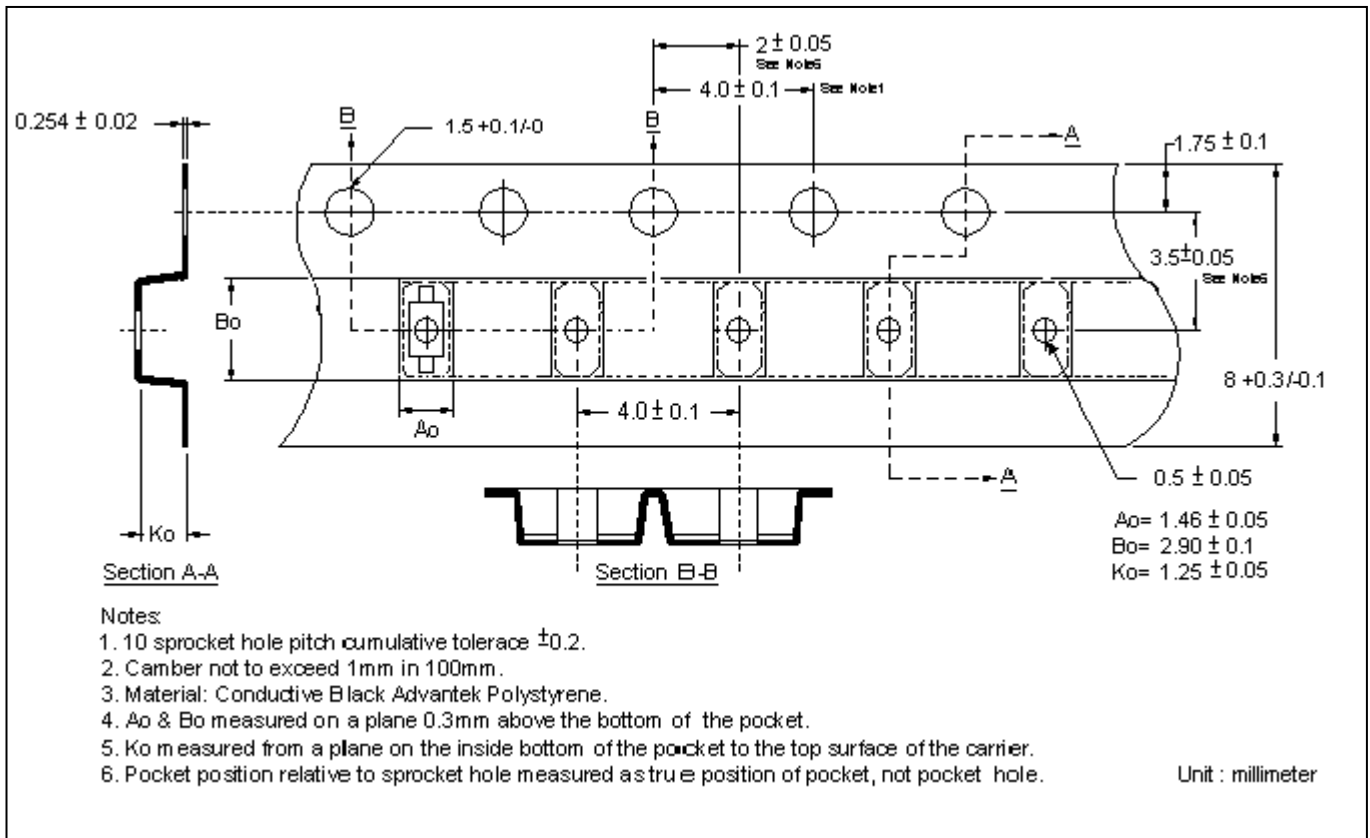

**Recommended wave soldering condition**

Product	Peak Temperature	Soldering Time
Pb-free devices	260 +0/-5 °C	5 +1/-1 seconds

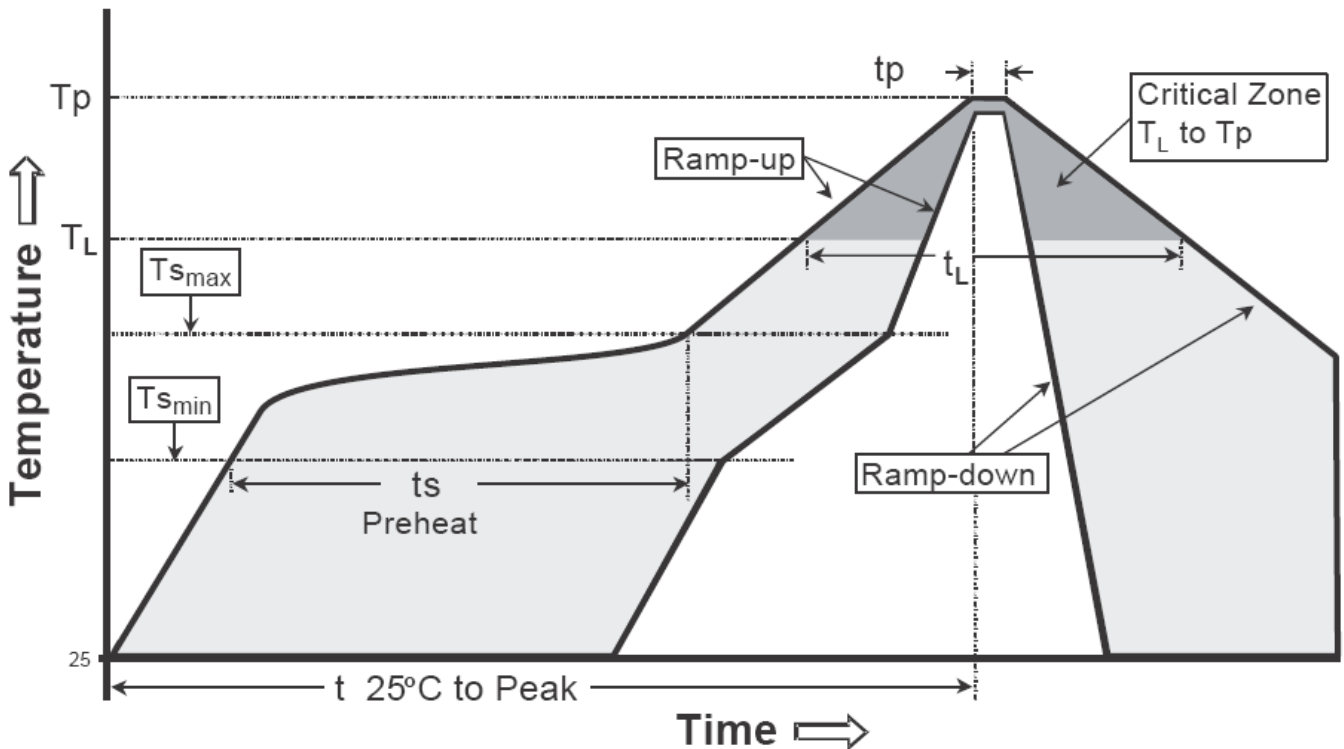
**Recommended temperature profile for IR reflow**

Profile feature	Sn-Pb eutectic Assembly	Pb-free Assembly
Average ramp-up rate (T <sub>smax</sub> to T <sub>p</sub> )	3°C/second max.	3°C/second max.
Preheat		
-Temperature Min(T <sub>s min</sub> )	100°C	150°C
-Temperature Max(T <sub>s max</sub> )	150°C	200°C
-Time(t <sub>s min</sub> to t <sub>s max</sub> )	60-120 seconds	60-180 seconds
Time maintained above:		
-Temperature (T <sub>L</sub> )	183°C	217°C
- Time (t <sub>L</sub> )	60-150 seconds	60-150 seconds
Peak Temperature(T <sub>p</sub> )	240 +0/-5 °C	260 +0/-5 °C
Time within 5°C of actual peak temperature(t <sub>p</sub> )	10-30 seconds	20-40 seconds
Ramp down rate	6°C/second max.	6°C/second max.
Time 25 °C to peak temperature	6 minutes max.	8 minutes max.

Note : All temperatures refer to topside of the package, measured on the package body surface.

**SOD-323 Dimension**

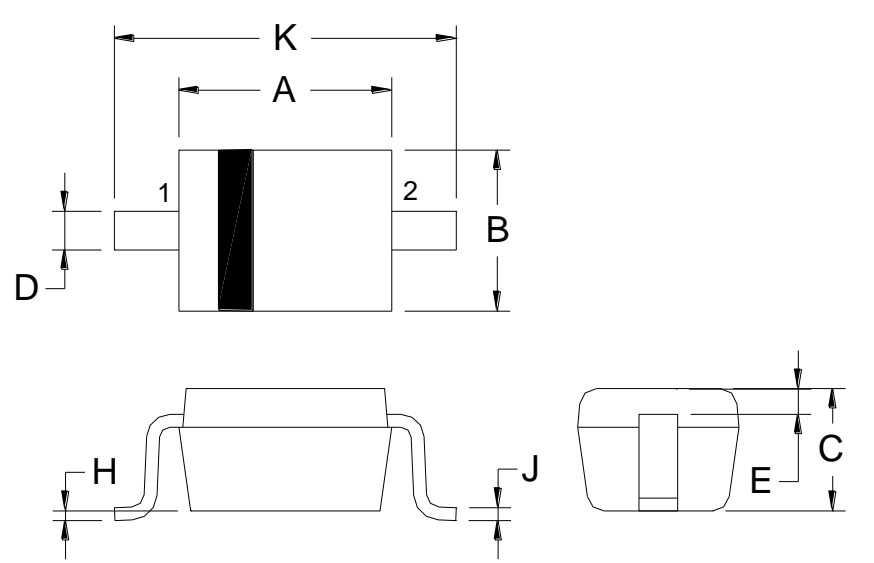

Marking:

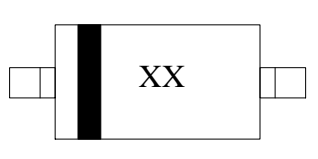

Style: Pin 1.Cathode 2.Anode

2-Lead SOD-323 Plastic  
 Surface Mounted Package  
 CYStek Package Code: S2

Type	Marking Code
CSOD5817S2	SJ
CSOD5818S2	SK
CSOD5819S2	SL

DIM	Inches		Millimeters		DIM	Inches		Millimeters	
	Min.	Max.	Min.	Max.		Min.	Max.	Min.	Max.
A	0.0630	0.0709	1.60	1.80	E	0.0060	-	0.15	-
B	0.0453	0.0531	1.15	1.35	H	0.0000	0.0040	0.00	0.10
C	0.0315	0.0394	0.80	1.00	J	0.0035	0.0070	0.089	0.177
D	0.0098	0.0157	0.25	0.40	K	0.0906	0.1063	2.30	2.70

Notes: 1.Controlling dimension : millimeters.  
 2.Lead thickness specified per L/F drawing with solder plating.  
 3.If there is any question with packing specification or packing method, please contact your local CYStek sales office.

**Material:**

- Lead: Pure tin plated.
- Mold Compound: Epoxy resin family, flammability solid burning class: UL94V-0.

**Important Notice:**

- All rights are reserved. Reproduction in whole or in part is prohibited without the prior written approval of CYStek.
- CYStek reserves the right to make changes to its products without notice.
- CYStek **semiconductor products are not warranted to be suitable for use in Life-Support Applications, or systems.**
- CYStek assumes no liability for any consequence of customer product design, infringement of patents, or application assistance.