

General Purpose NPN Epitaxial Planar Transistor

BTN6718T3

Features

- High breakdown voltage, $BV_{CEO} \geq 100V$
- Large continuous collector current capability, $I_{C(MAX)}=1A(DC)$
- Low collector saturation voltage
- Pb-free lead plating package

Symbol

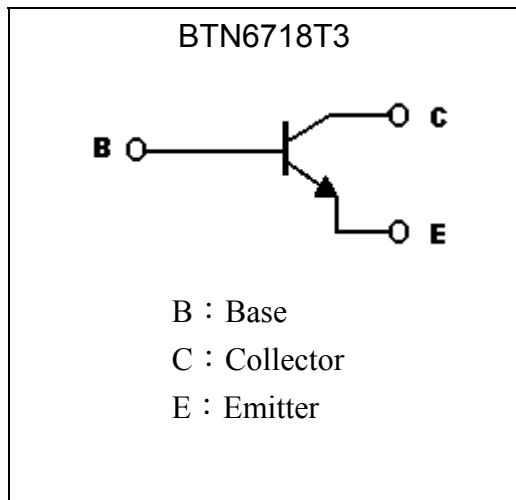

Outline

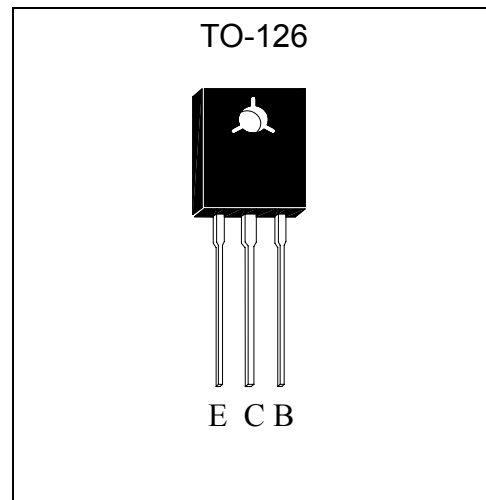

Ordering Information

Device	Package	Shipping
BTN6718T3-0-BL-X	TO-126 (Pb-free lead plating package)	200 pcs / bag, 15 bags/box

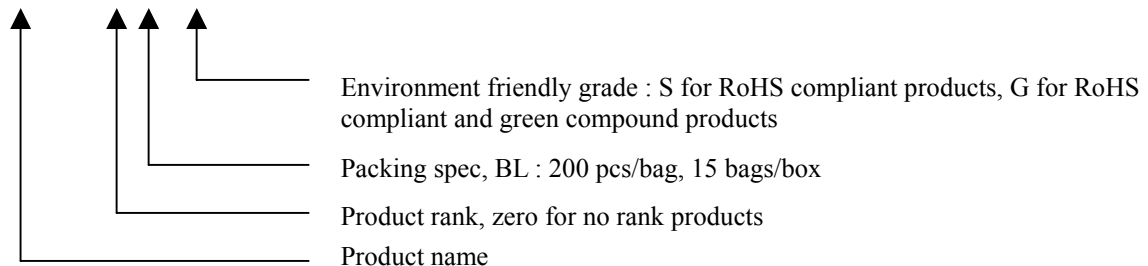



Absolute Maximum Ratings (Ta=25°C)

Parameter	Symbol	Limits	Unit
Collector-Base Voltage	V _{CB0}	180	V
Collector-Emitter Voltage	V _{CE0}	100	V
Emitter-Base Voltage	V _{EB0}	5	V
Collector Current(DC)	I _C	1	A
Collector Current(Pulsed)	I _{CP}	2 (Note)	A
Base Current	I _B	0.2	A
Power Dissipation(T _A =25°C)	P _d	1.6	W
Power Dissipation(T _C =25°C)		10	W
Junction Temperature	T _j	150	°C
Storage Temperature	T _{stg}	-55~+150	°C

Note : Single pulse, Pw≤300μs, Duty Cycle≤2%.

Characteristics (Ta=25°C)

Symbol	Min.	Typ.	Max.	Unit	Test Conditions
BV _{CB0}	180	-	-	V	I _C =100μA
BV _{CE0}	100	-	-	V	I _C =1mA
BV _{EB0}	5	-	-	V	I _E =10μA
I _{CB0}	-	-	100	nA	V _{CB} =180V, I _E =0
I _{EB0}	-	-	100	nA	V _{EB} =5V, I _C =0
*V _{CE(SAT)}	-	-	200	mV	I _C =350mA, I _B =35mA
*h _{FE} 1	90	-	-	-	V _{CE} =1V, I _C =50mA
*h _{FE} 2	100	-	300	-	V _{CE} =1V, I _C =250mA
*h _{FE} 3	20	-	-	-	V _{CE} =1V, I _C =500mA
f _T	50	-	-	MHz	V _{CE} =10V, I _C =50mA, f=100MHz
Cob	-	-	20	pF	V _{CB} =10V, I _E =0A, f=1MHz

*Pulse Test: Pulse Width ≤380μs, Duty Cycle≤2%



Typical Characteristics

Current Gain vs Collector Current

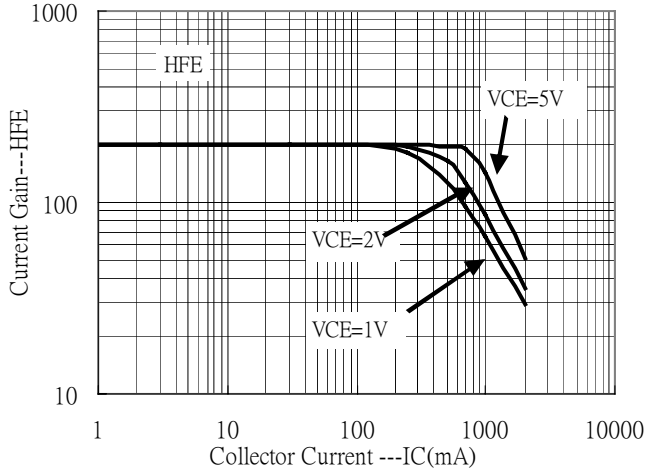

Saturation Voltage vs Collector Current

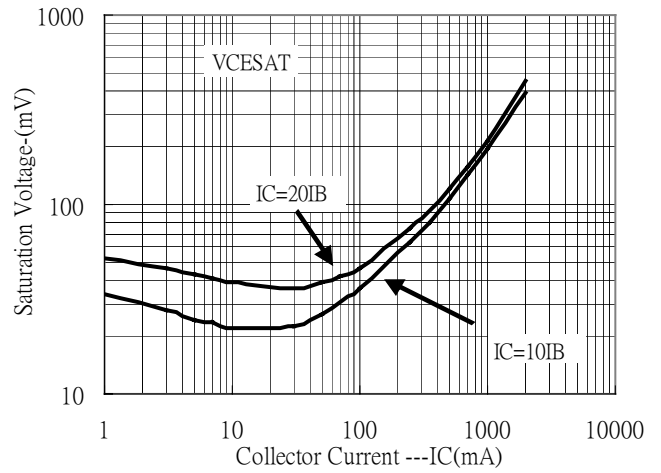

Saturation Voltage vs Collector Current

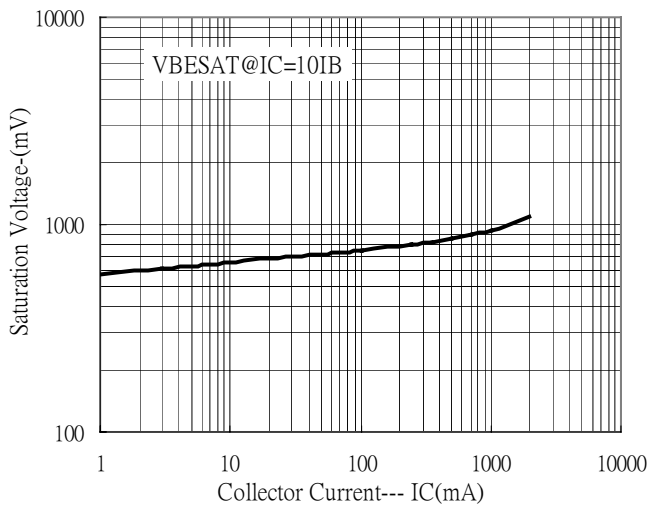

On Voltage vs Collector Current

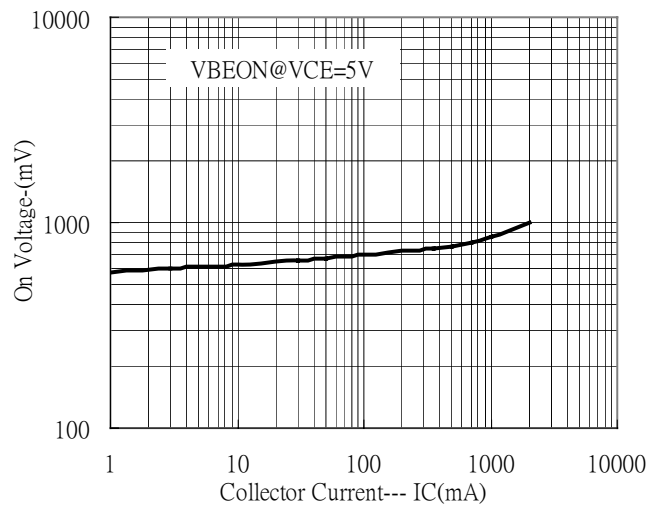

Power Derating Curve

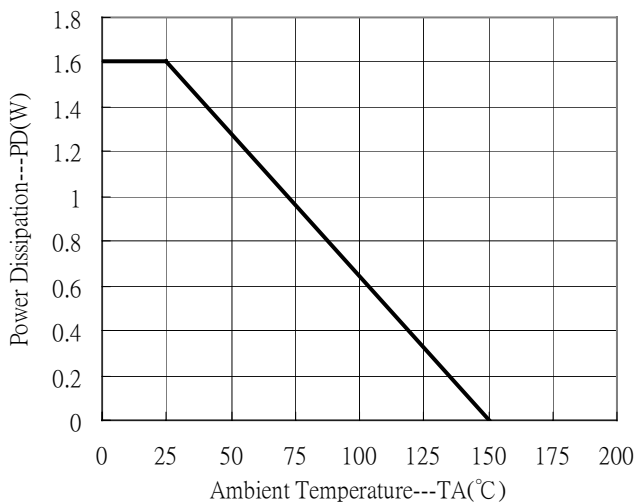

Power Derating Curve

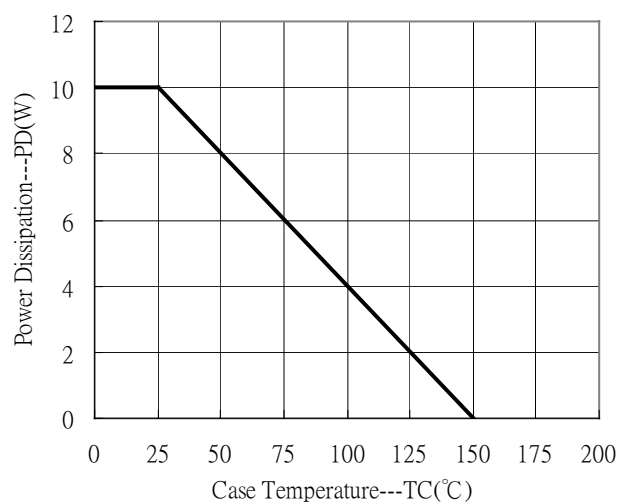



Typical Characteristics(Cont.)

Safe Operating Area

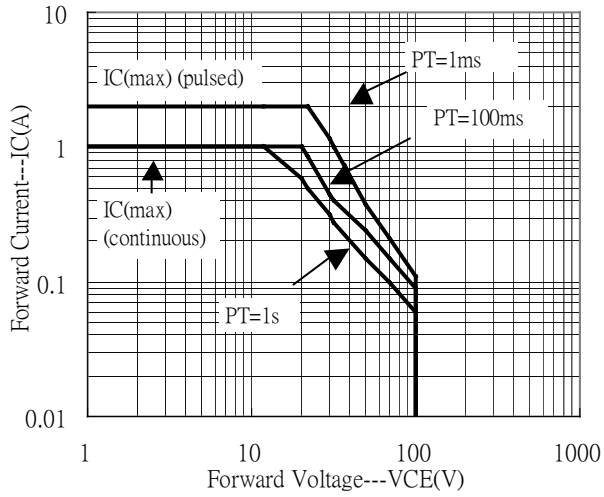

Recommended wave soldering condition

Product	Peak Temperature	Soldering Time
Pb-free devices	260 +0/-5 °C	5 +1/-1 seconds

Recommended temperature profile for IR reflow

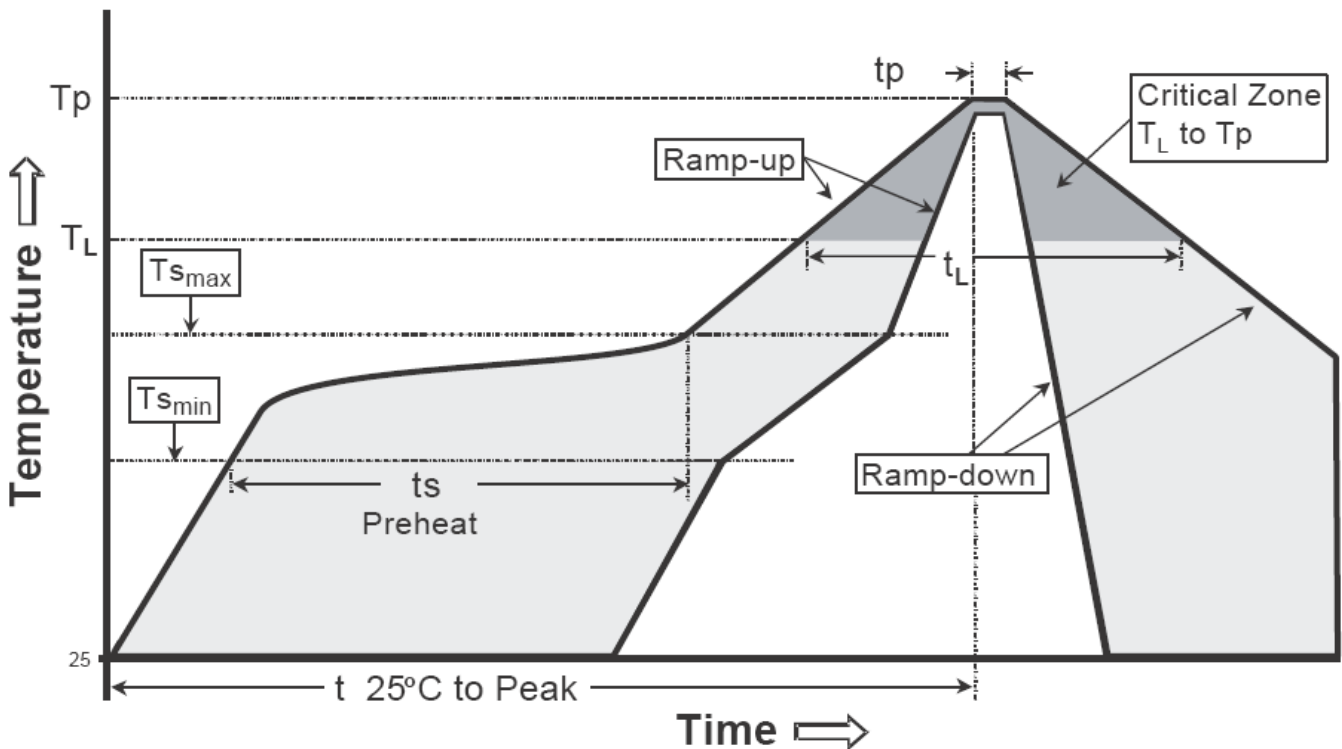

Profile feature	Sn-Pb eutectic Assembly	Pb-free Assembly
Average ramp-up rate (T _{smax} to T _p)	3°C/second max.	3°C/second max.
Preheat		
-Temperature Min(T _{s min})	100°C	150°C
-Temperature Max(T _{s max})	150°C	200°C
-Time(t _{s min} to t _{s max})	60-120 seconds	60-180 seconds
Time maintained above:		
-Temperature (T _L)	183°C	217°C
- Time (t _L)	60-150 seconds	60-150 seconds
Peak Temperature(T _p)	240 +0/-5 °C	260 +0/-5 °C
Time within 5°C of actual peak temperature(tp)	10-30 seconds	20-40 seconds
Ramp down rate	6°C/second max.	6°C/second max.
Time 25 °C to peak temperature	6 minutes max.	8 minutes max.

Note : All temperatures refer to topside of the package, measured on the package body surface.

TO-126 Dimension

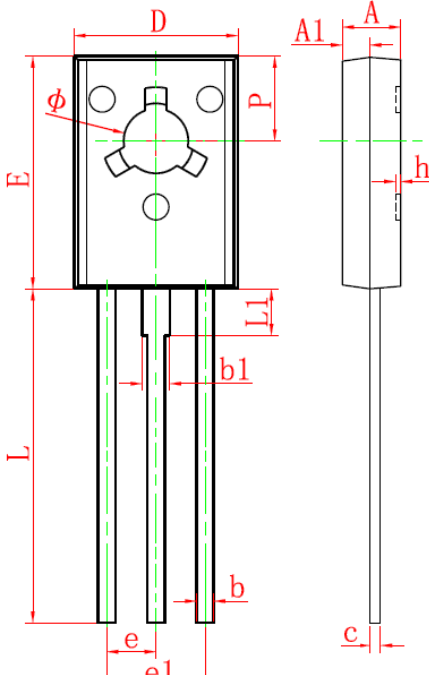

3-Lead TO-126 Plastic Package
CYStek Package Code: T3

Marking:

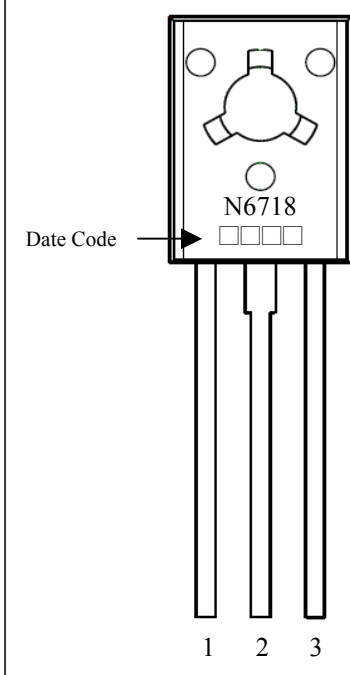

Style: Pin 1. Emitter 2. Collector 3. Base

*: Typical

DIM	Millimeters		Inches		DIM	Millimeters		Inches	
	Min.	Max.	Min.	Max.		Min.	Max.	Min.	Max.
A	2.500	2.900	0.098	0.114	e	*2.290		*0.090	
A1	1.100	1.500	0.043	0.059	e1	4.480	4.680	0.176	0.184
b	0.660	0.860	0.026	0.034	h	0.000	0.300	0.000	0.012
b1	1.170	1.370	0.046	0.054	L	15.300	15.700	0.602	0.618
c	0.450	0.600	0.018	0.024	L1	2.100	2.300	0.083	0.091
D	7.400	7.800	0.291	0.307	P	3.900	4.100	0.154	0.161
E	10.600	11.000	0.417	0.433	Φ	3.000	3.200	0.118	0.126

- Notes:**
- Controlling dimension: millimeters.
 - Maximum lead thickness includes lead finish thickness, and minimum lead thickness is the minimum thickness of base material.
 - If there is any question with packing specification or packing method, please contact your local CYStek sales office.

Material:

- Lead: Pure tin plated.
- Mold Compound: Epoxy resin family, flammability solid burning class: UL94V-0.

Important Notice:

- All rights are reserved. Reproduction in whole or in part is prohibited without the prior written approval of CYStek.
- CYStek reserves the right to make changes to its products without notice.
- CYStek **semiconductor products are not warranted to be suitable for use in Life-Support Applications, or systems.**
- CYStek assumes no liability for any consequence of customer product design, infringement of patents, or application assistance.