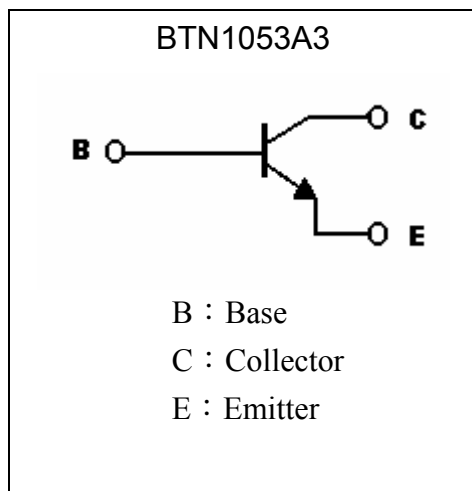
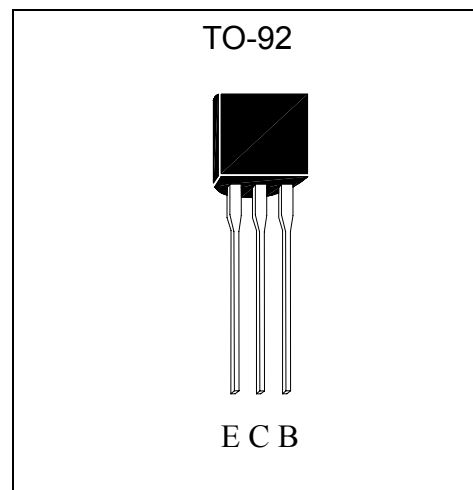

Low Vcesat NPN Epitaxial Planar Transistor

BTN1053A3

Features

- Excellent H_{FE} Characteristics up to 1A
- Low Saturation Voltage, $V_{CE(sat)}=0.1V(\text{typ})@I_C=1A, I_B=50mA$
- 5A peak pulse current
- Pb-free lead plating and halogen-free package

Symbol

Outline

Absolute Maximum Ratings ($T_a=25^\circ\text{C}$)

Parameter	Symbol	Limit	Unit
Collector-Base Voltage	V_{CBO}	150	V
Collector-Emitter Voltage	V_{CEO}	80	V
Emitter-Base Voltage	V_{EBO}	6	V
Collector Current	$I_C(\text{DC})$	2	A
	$I_C(\text{Pulse})$	5 (Note)	A
Power Dissipation	P_d	750	mW
Operating Junction Temperature Range	T_j	-55~+150	$^\circ\text{C}$
Storage Temperature Range	T_{stg}	-55~+150	$^\circ\text{C}$

 Note : *1. Single Pulse $P_w \leq 350\mu\text{s}$, Duty $\leq 2\%$.

**Characteristics (Ta=25°C)**

Symbol	Min.	Typ.	Max.	Unit	Test Conditions
BV _{CBO}	150	250	-	V	I _C =100μA
BV _{CEO}	80	110	-	V	I _C =10mA
BV _{EBO}	6	7.4	-	V	I _E =10μA
I _{CBO}	-	-	100	nA	V _{CB} =150V
I _{EBO}	-	-	100	nA	V _{EB} =6V
V _{CE(sat)} 1 *	-	25	40	mV	I _C =200mA, I _B =20mA
V _{CE(sat)} 2 *	-	65	150	mV	I _C =500mA, I _B =20mA
V _{CE(sat)} 3 *	-	200	400	mV	I _C =1A, I _B =10mA
V _{CE(sat)} 4 *	-	100	250	mV	I _C =1A, I _B =50mA
V _{CE(sat)} 5 *	-	190	300	mV	I _C =2A, I _B =100mA
V _{BE(sat)} *	-	0.83	1.2	V	I _C =1A, I _B =50mA
V _{BE(on)} *	-	0.92	1.2	V	V _{CE} =2V, I _C =3A
h _{FE} 1 *	300	-	-	-	V _{CE} =2V, I _C =10mA
h _{FE} 2 *	300	-	820	-	V _{CE} =2V, I _C =500mA
h _{FE} 3 *	120	-	-	-	V _{CE} =2V, I _C =1A
h _{FE} 4 *	30	-	-	-	V _{CE} =2V, I _C =2A
f _T	-	140	-	MHz	V _{CE} =10V, I _C =50mA, f=100MHz
C _{ob}	-	23	-	pF	V _{CB} =10V, I _E =0A, f=1MHz

*Pulse Test: Pulse Width ≤300μs, Duty Cycle ≤2%

Ordering Information

Device	Package	Shipping
BTN1053A3-0-BK-G	TO-92 (Pb-free lead plating and halogen-free package)	1000 pcs/ bag, 10 bags/box, 10boxes/carton
BTN1053A3-0-TB-G		2000 pcs / Tape & Box

Typical Characteristics

Emitter Grounded Output Characteristics

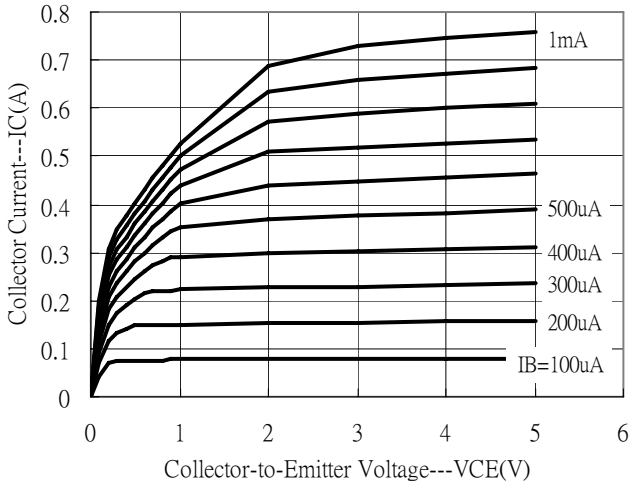

Emitter Grounded Output Characteristics

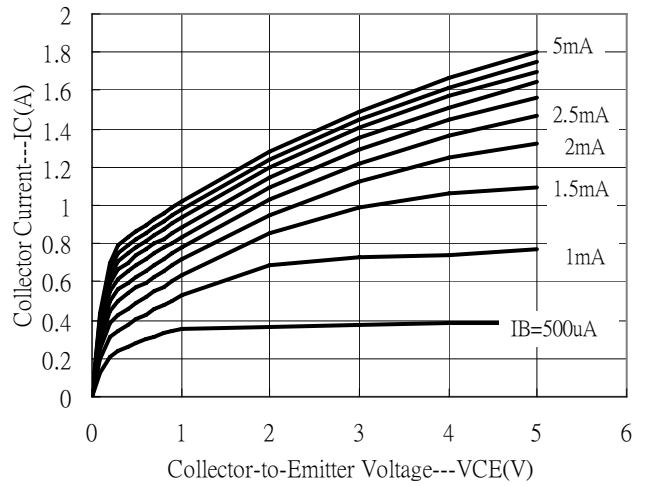

Emitter Grounded Output Characteristics

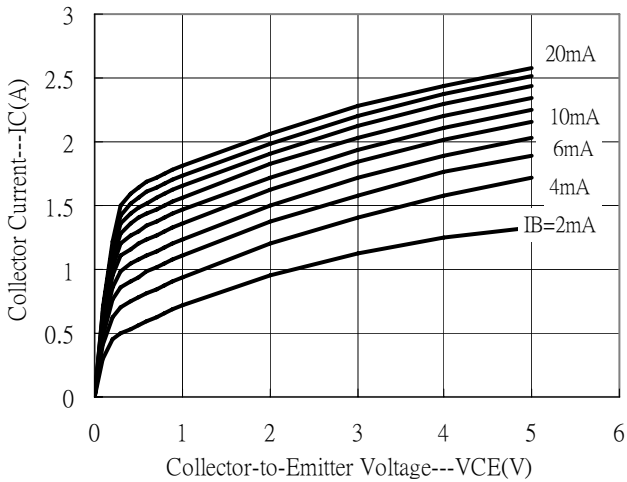

Emitter Grounded Output Characteristics

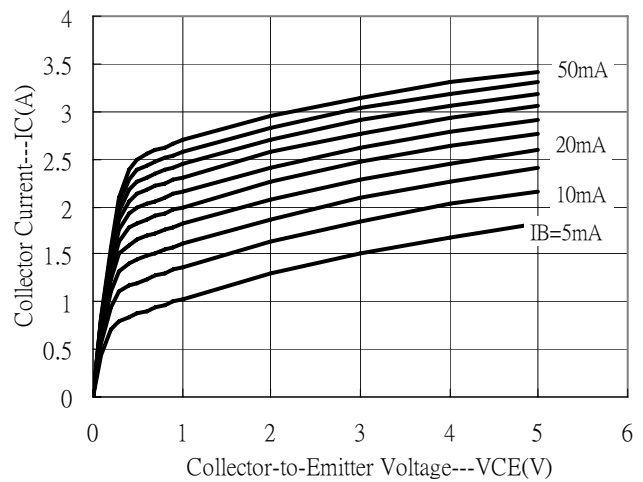

Current Gain vs Collector Current

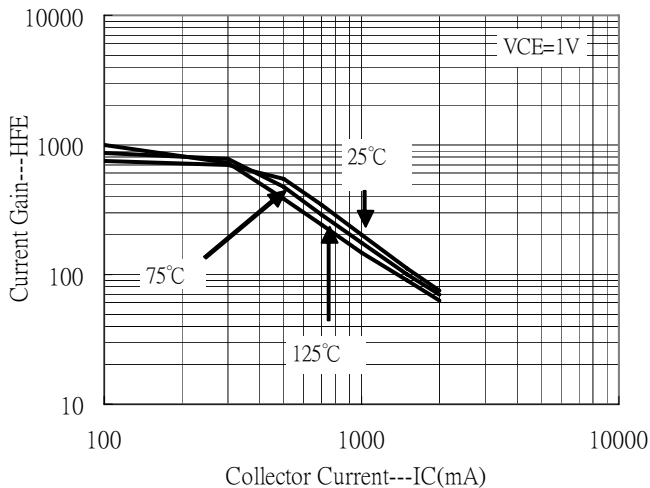

Current Gain vs Collector Current

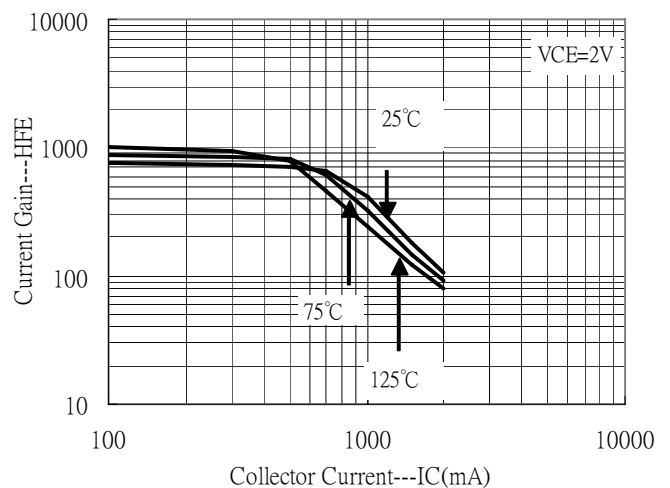

Typical Characteristics(Cont.)

Current Gain vs Collector Current

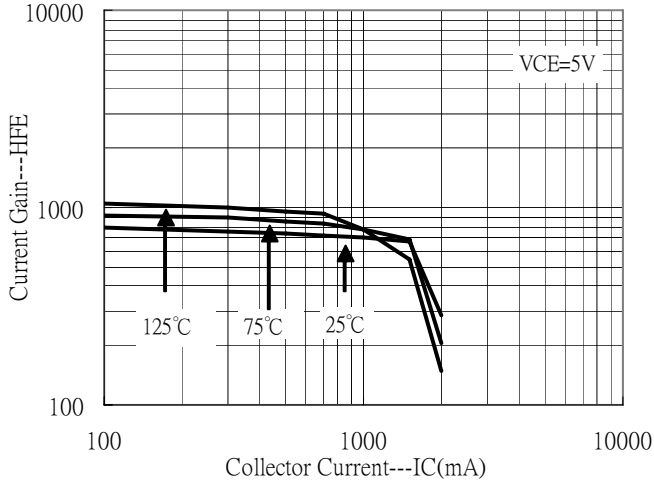

Saturation Voltage vs Collector Current

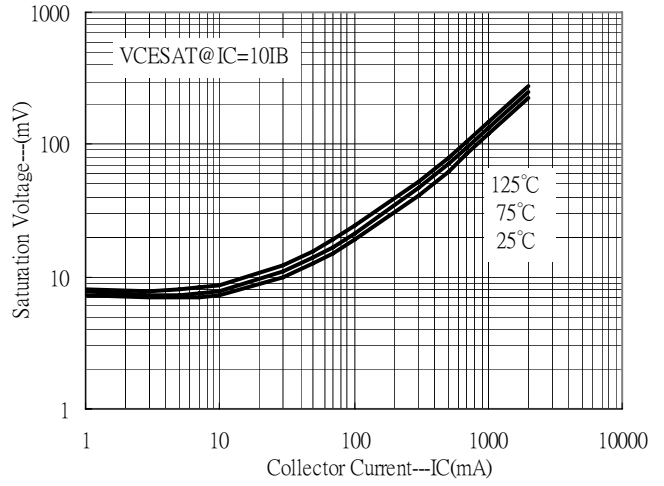

Saturation Voltage vs Collector Current

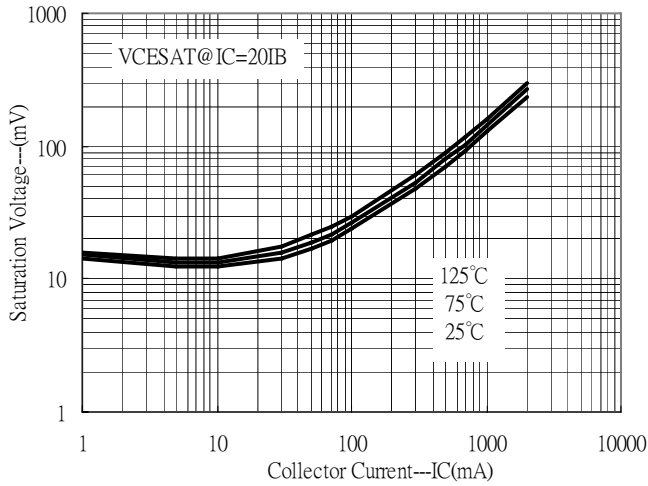

Saturation Voltage vs Collector Current

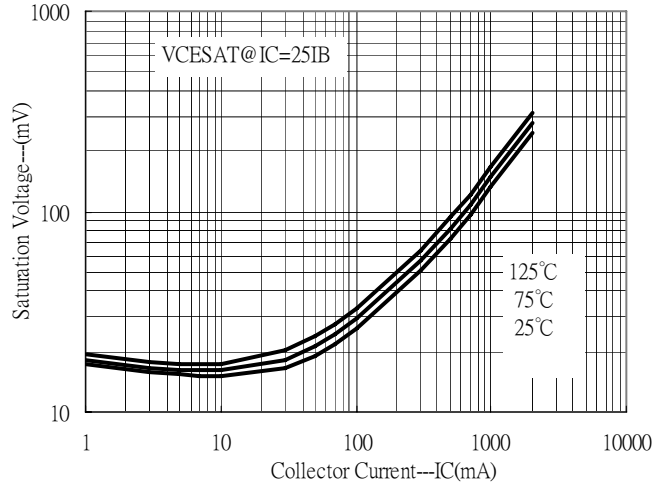

Saturation Voltage vs Collector Current

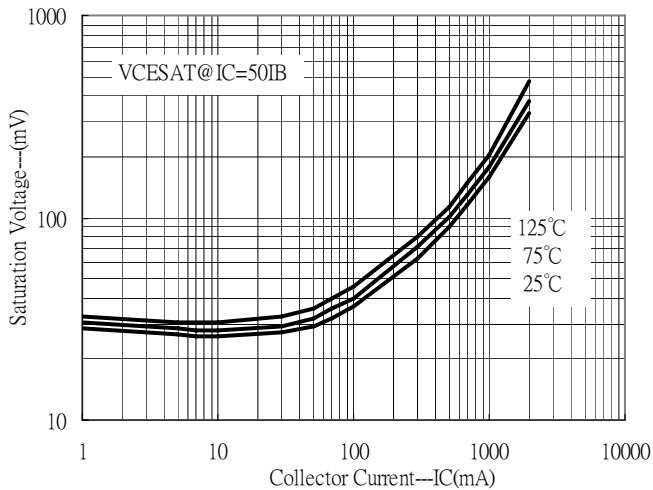

Saturation Voltage vs Collector Current

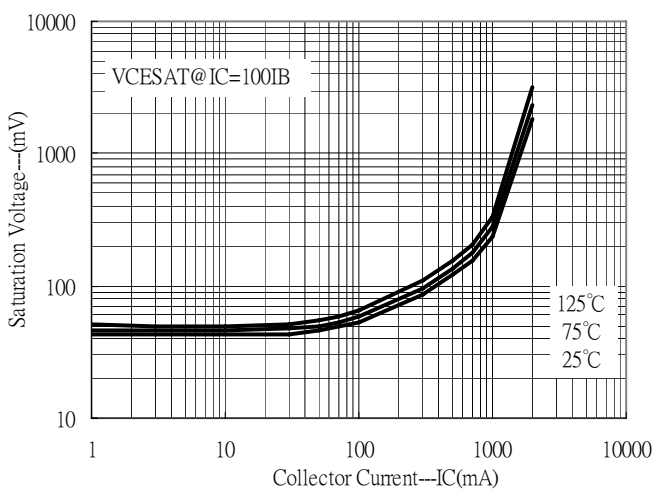

Typical Characteristics(Cont.)

On Voltage vs Collector Current

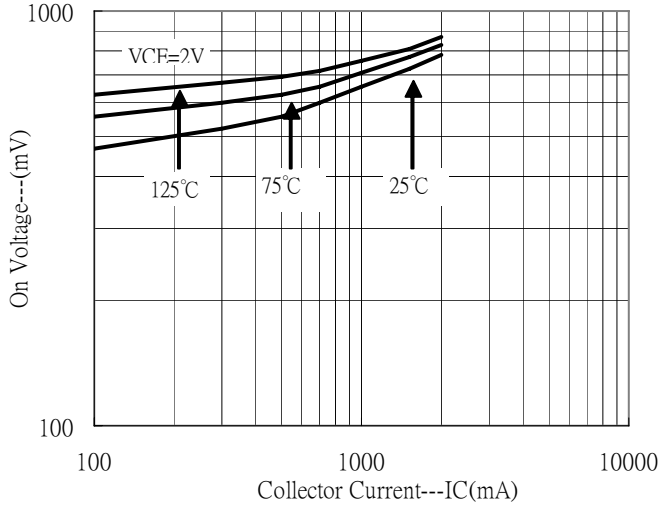

Capacitance vs Reverse-biased Voltage

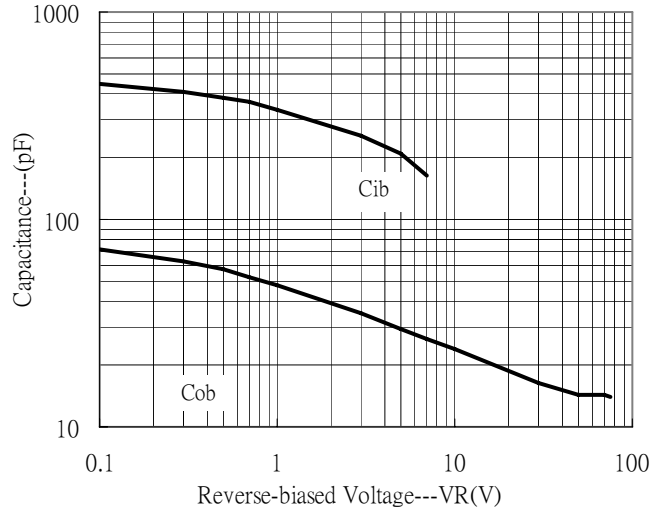

Power Derating Curve

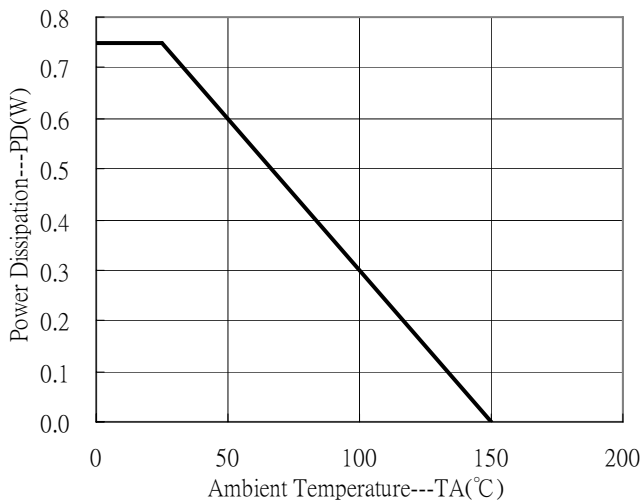

Safe Operating Area

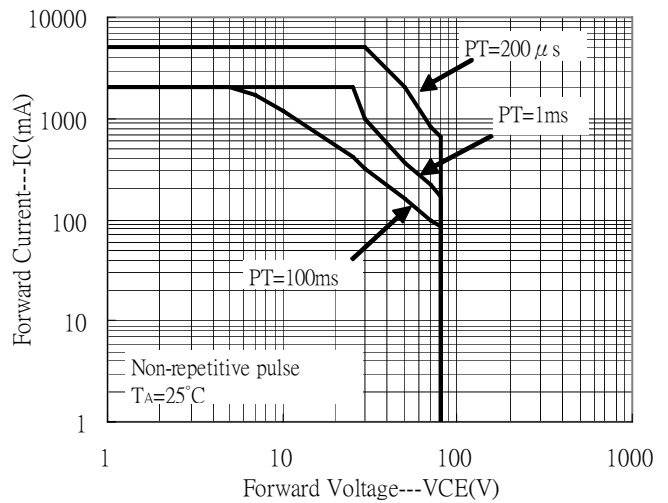

TO-92 Taping Outline

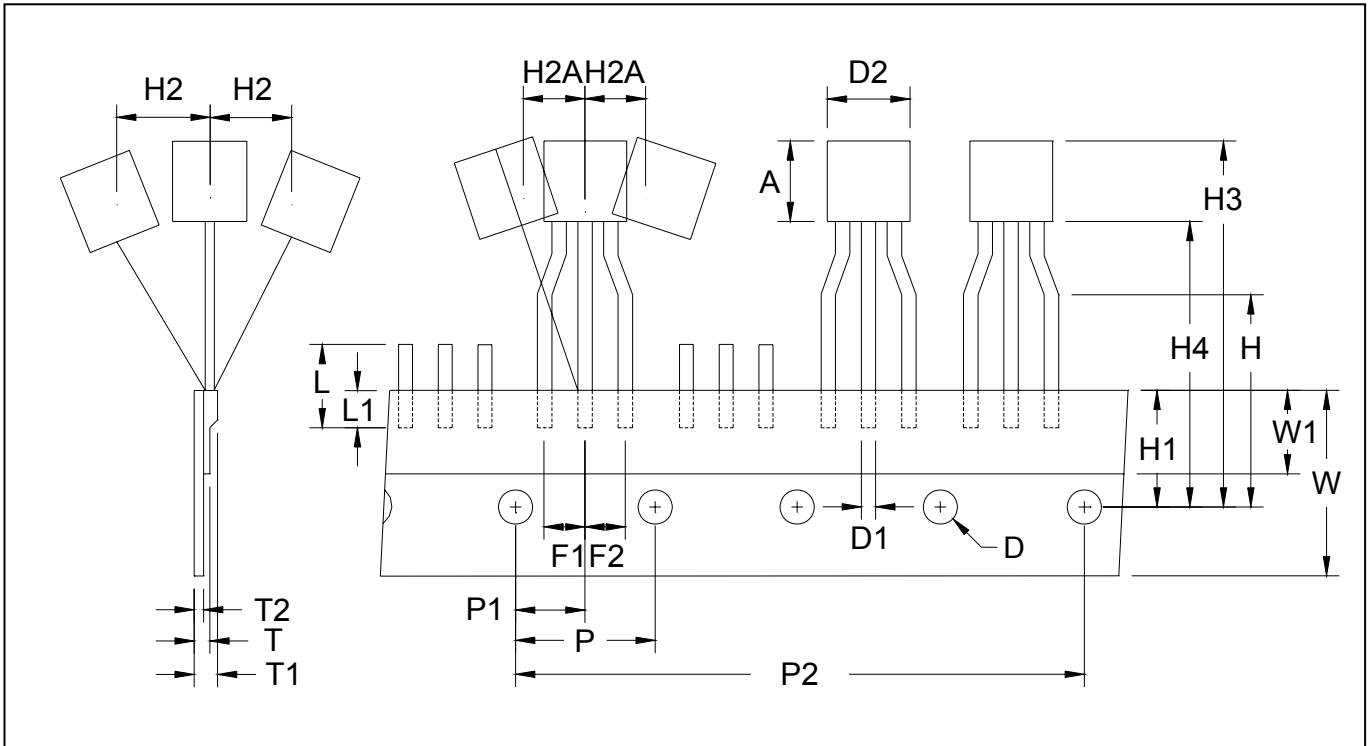

DIM	Item	Millimeters	
		Min.	Max.
A	Component body height	4.33	4.83
D	Tape Feed Diameter	3.80	4.20
D1	Lead Diameter	0.36	0.53
D2	Component Body Diameter	4.33	4.83
F1,F2	Component Lead Pitch	2.40	2.90
F1,F2	F1-F2	-	±0.3
H	Height Of Seating Plane	15.50	16.50
H1	Feed Hole Location	8.50	9.50
H2	Front To Rear Deflection	-	1
H2A	Deflection Left Or Right	-	1
H3	Component Height	-	27
H4	Feed Hole To Bottom Of Component	-	21
L	Lead Length After Component Removal	-	11
L1	Lead Wire Enclosure	2.50	-
P	Feed Hole Pitch	12.50	12.90
P1	Center Of Seating Plane Location	5.95	6.75
P2	4 Feed Hole Pitch	50.30	51.30
T	Over All Tape Thickness	-	0.55
T1	Total Taped Package Thickness	-	1.42
T2	Carrier Tape Thickness	0.36	0.68
W	Tape Width	17.50	19.00
W1	Adhesive Tape Width	5.00	7.00
-	20 pcs Pitch	253	255

Recommended wave soldering condition

Product	Peak Temperature	Soldering Time
Pb-free devices	260 +0/-5 °C	5 +1/-1 seconds

Recommended temperature profile for IR reflow

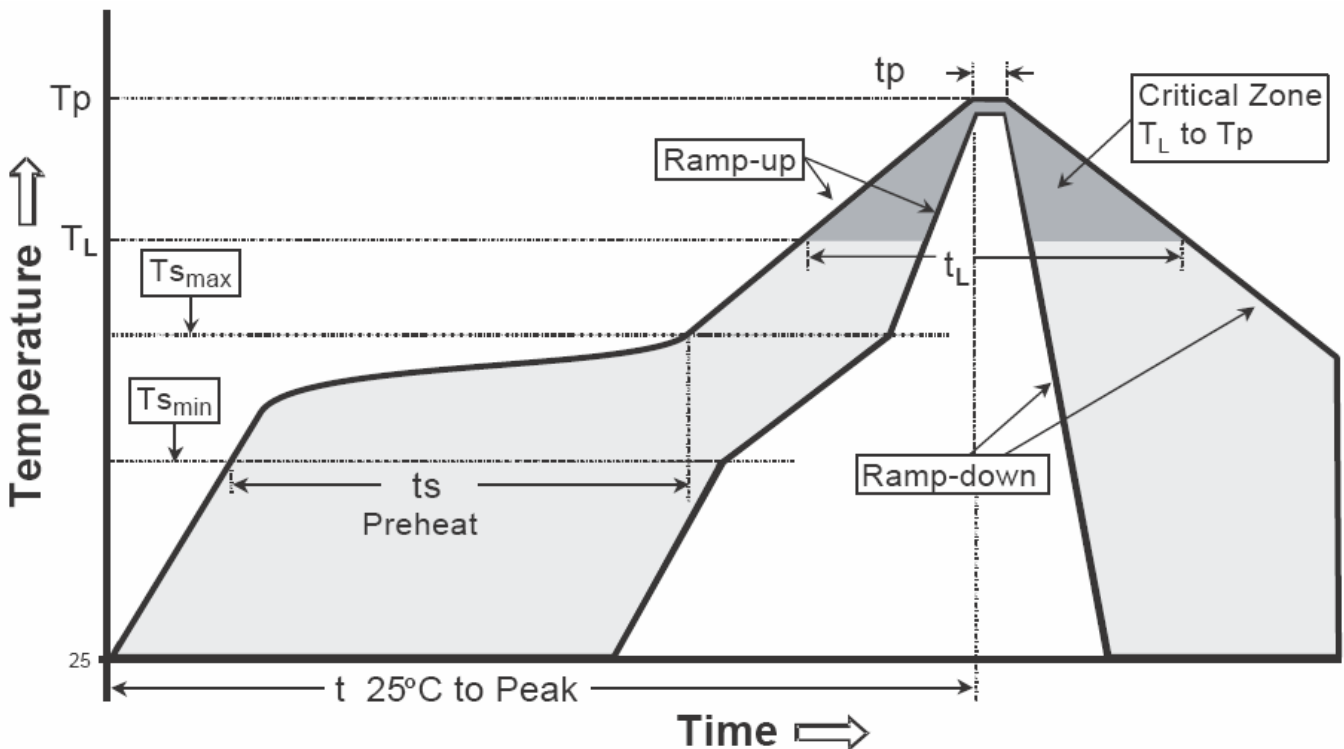

Profile feature	Sn-Pb eutectic Assembly	Pb-free Assembly
Average ramp-up rate (Tsmax to Tp)	3°C/second max.	3°C/second max.
Preheat		
-Temperature Min(Ts min)	100°C	150°C
-Temperature Max(Ts max)	150°C	200°C
-Time(ts min to ts max)	60-120 seconds	60-180 seconds
Time maintained above:		
-Temperature (TL)	183°C	217°C
- Time (tL)	60-150 seconds	60-150 seconds
Peak Temperature(TP)	240 +0/-5 °C	260 +0/-5 °C
Time within 5°C of actual peak temperature(tp)	10-30 seconds	20-40 seconds
Ramp down rate	6°C/second max.	6°C/second max.
Time 25 °C to peak temperature	6 minutes max.	8 minutes max.

Note : All temperatures refer to topside of the package, measured on the package body surface.

TO-92 Dimension

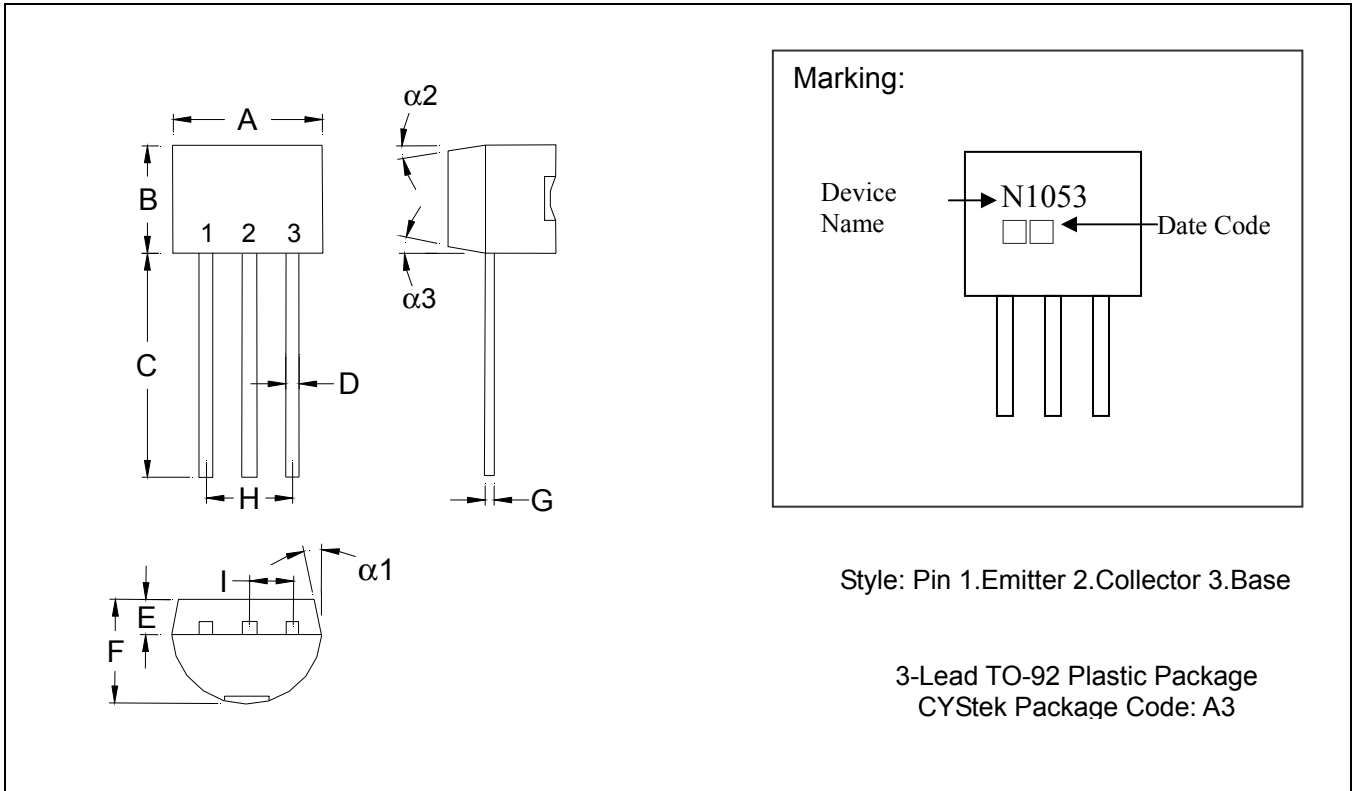

*: Typical

DIM	Inches		Millimeters		DIM	Inches		Millimeters	
	Min.	Max.	Min.	Max.		Min.	Max.	Min.	Max.
A	0.1704	0.1902	4.33	4.83	G	0.0142	0.0220	0.36	0.56
B	0.1704	0.1902	4.33	4.83	H	-	*0.1000	-	*2.54
C	0.5000	-	12.70	-	I	-	*0.0500	-	*1.27
D	0.0142	0.0220	0.36	0.56	$\alpha 1$	-	*5°	-	*5°
E	-	*0.0500	-	*1.27	$\alpha 2$	-	*2°	-	*2°
F	0.1323	0.1480	3.36	3.76	$\alpha 3$	-	*2°	-	*2°

Notes: 1. Controlling dimension: millimeters.
 2. Maximum lead thickness includes lead finish thickness, and minimum lead thickness is the minimum thickness of base material.
 3. If there is any question with packing specification or packing method, please contact your local CYStek sales office.

Material:

- Lead: Pure tin plated.
- Mold Compound: Epoxy resin family, flammability solid burning class: UL94V-0.

Important Notice:

- All rights are reserved. Reproduction in whole or in part is prohibited without the prior written approval of CYStek.
- CYStek reserves the right to make changes to its products without notice.
- CYStek **semiconductor products are not warranted to be suitable for use in Life-Support Applications, or systems.**
- CYStek assumes no liability for any consequence of customer product design, infringement of patents, or application assistance.