

**High Frequency Amplifier Transistor (11V, 50mA, 3.2GHz)**

# BTC3838N3

## Features

- High transition frequency,  $f_T=3.2\text{GHz}(\text{typ.})$
- Low output capacitance,  $C_{ob}=0.8\text{pF}(\text{typ.})$

## Applications

- UHF converter.
- Local oscillator

## Symbol

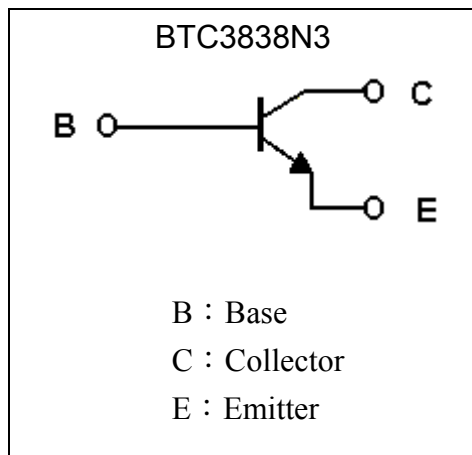

## Outline

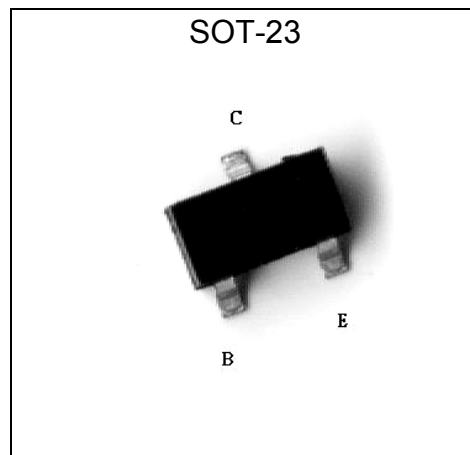

## Absolute Maximum Ratings (Ta=25°C)

Parameter	Symbol	Limits	Unit
Collector-Base Voltage	V <sub>CB0</sub>	20	V
Collector-Emitter Voltage	V <sub>CE0</sub>	11	V
Emitter-Base Voltage	V <sub>EB0</sub>	5	V
Collector Current	I <sub>C</sub>	50	mA
Power Dissipation	P <sub>d</sub>	200	mW
Junction Temperature	T <sub>j</sub>	150	°C
Storage Temperature	T <sub>stg</sub>	-55~+150	°C



**Characteristics (Ta=25°C)**

Symbol	Min.	Typ.	Max.	Unit	Test Conditions
$BV_{CBO}$	20	-	-	V	$I_C=10\mu A, I_E=0$
$BV_{CEO}$	11	-	-	V	$I_C=1mA, I_B=0$
$BV_{EBO}$	3	-	-	V	$I_E=10\mu A, I_C=0$
$I_{CBO}$	-	-	500	nA	$V_{CB}=10V, I_E=0$
$I_{EBO}$	-	-	500	nA	$V_{EB}=2V, I_C=0$
* $V_{CE(sat)}$	-	-	0.5	V	$I_C=10mA, I_B=5mA$
* $h_{FE}$	56	-	270	-	$V_{CE}=10V, I_C=5mA$
$f_T$	1.4	3.2	-	GHz	$V_{CE}=10V, I_C=10mA, f=500MHz$
Cob	-	0.8	1.5	pF	$V_{CB}=10V, I_E=0, f=1MHz$

\*Pulse Test: Pulse Width  $\leq 380\mu s$ , Duty Cycle  $\leq 2\%$

**Classification Of  $h_{FE}$**

Rank	N	P	Q
Range	56~120	82~180	120~270



### Characteristic Curves

Current Gain vs Collector Current

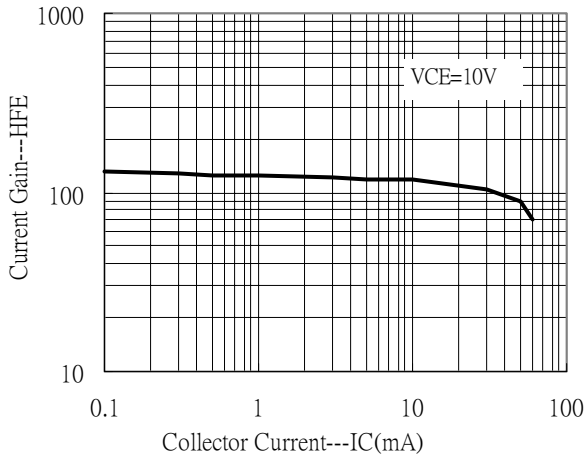

Saturation Voltage vs Collector Current

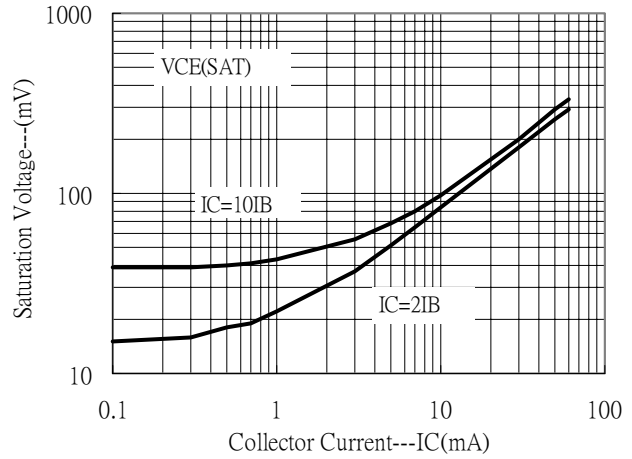

Saturation Voltage vs Collector Current

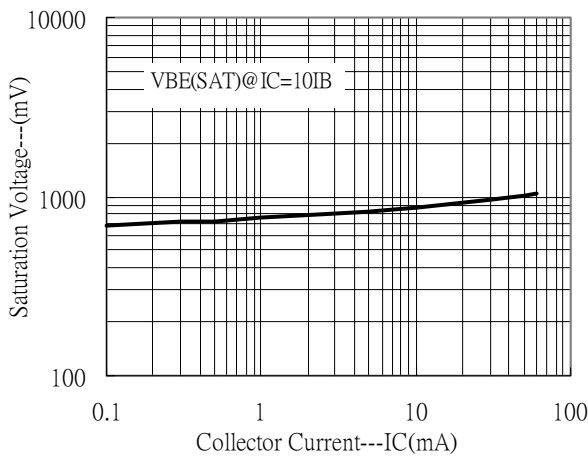

Cutoff Frequency vs Collector Current

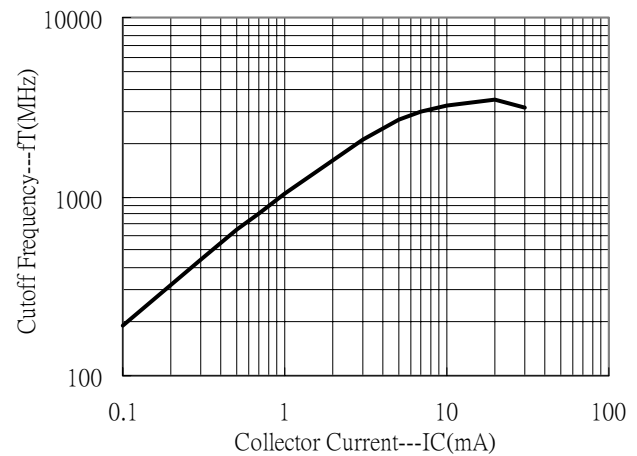

Output Capacitance vs Reverse Biased Voltage

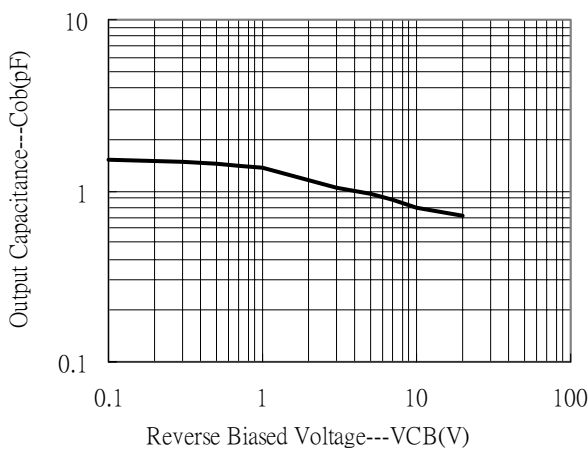

Power Derating Curve

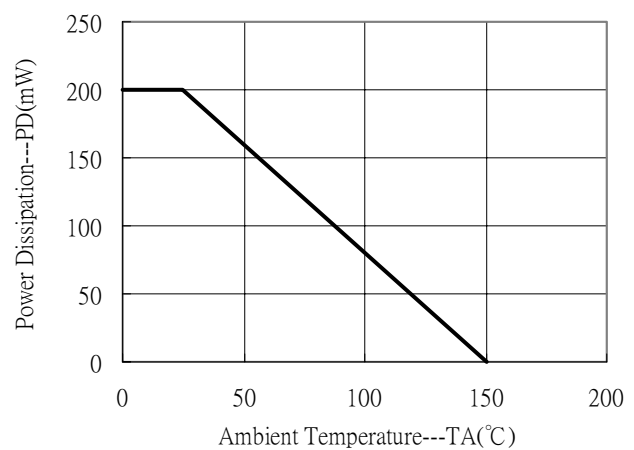

**SOT-23 Dimension**

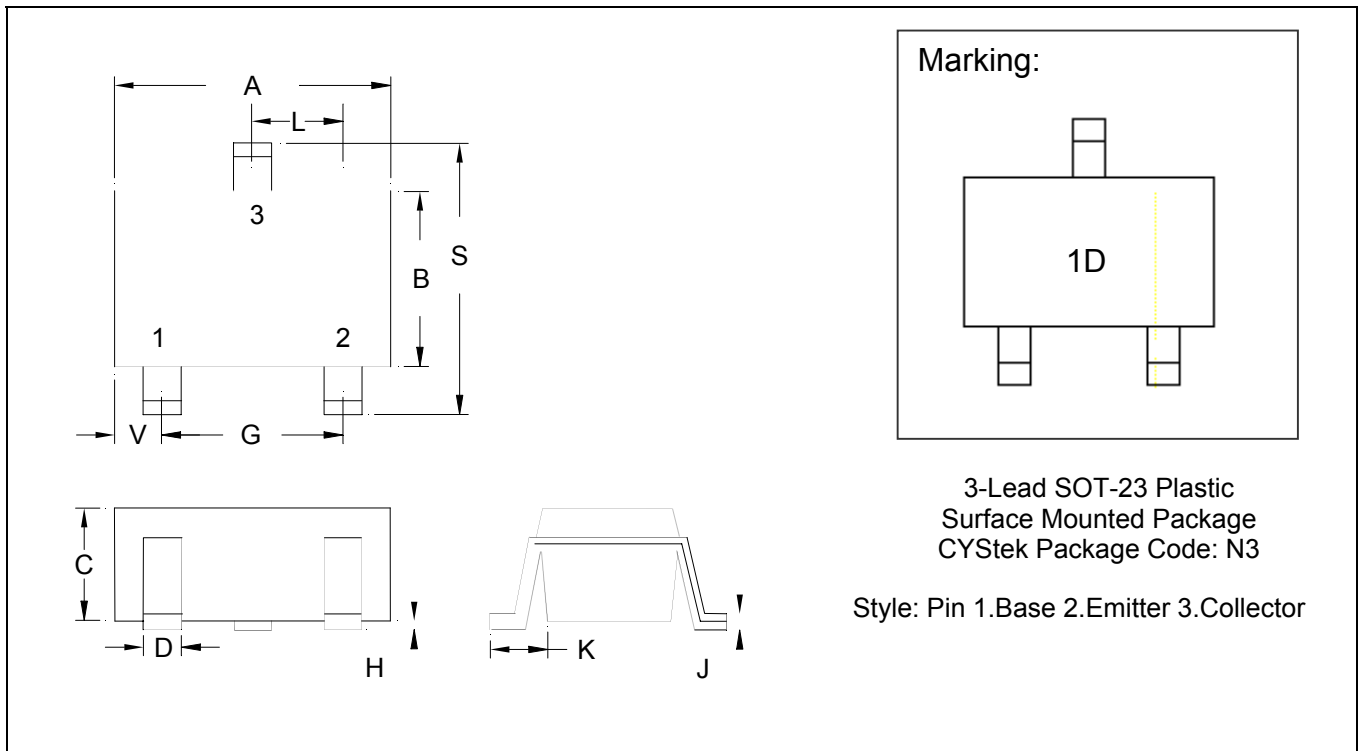

3-Lead SOT-23 Plastic  
 Surface Mounted Package  
 CYStek Package Code: N3  
 Style: Pin 1.Base 2.Emitter 3.Collector

\*: Typical

DIM	Inches		Millimeters		DIM	Inches		Millimeters	
	Min.	Max.	Min.	Max.		Min.	Max.	Min.	Max.
A	0.1102	0.1204	2.80	3.04	J	0.0034	0.0070	0.085	0.177
B	0.0472	0.0630	1.20	1.60	K	0.0128	0.0266	0.32	0.67
C	0.0335	0.0512	0.89	1.30	L	0.0335	0.0453	0.85	1.15
D	0.0118	0.0197	0.30	0.50	S	0.0830	0.1083	2.10	2.75
G	0.0669	0.0910	1.70	2.30	V	0.0098	0.0256	0.25	0.65
H	0.0005	0.0040	0.013	0.10					

- Notes: 1.Controlling dimension: millimeters.  
 2.Maximum lead thickness includes lead finish thickness, and minimum lead thickness is the minimum thickness of base material.  
 3.If there is any question with packing specification or packing method, please contact your local CYStek sales office.

**Material:**

- Lead: 42 Alloy ; solder plating
- Mold Compound: Epoxy resin family, flammability solid burning class: UL94V-0

**Important Notice:**

- All rights are reserved. Reproduction in whole or in part is prohibited without the prior written approval of CYStek.
- CYStek reserves the right to make changes to its products without notice.
- CYStek **semiconductor products are not warranted to be suitable for use in Life-Support Applications, or systems.**
- CYStek assumes no liability for any consequence of customer product design, infringement of patents, or application assistance.