

High Voltage PNP Epitaxial Planar Transistor

BTA1727L3

Features

- High breakdown voltage, $BV_{CEO}=-400V$
- Low saturation voltage
- High switching speed.
- Complementary to BTD2568L3
- Pb-free lead plating package

Symbol

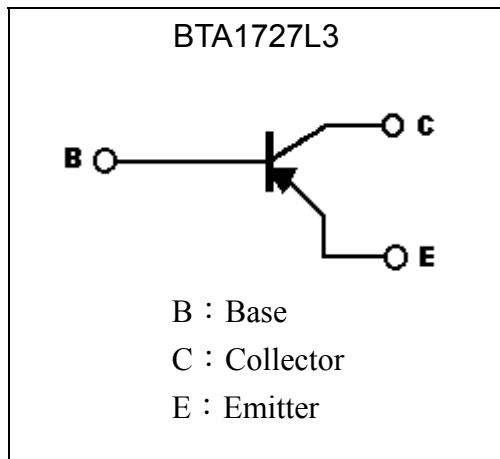

Outline

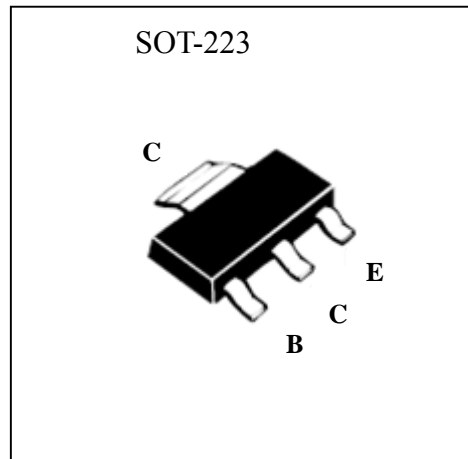

Ordering Information

Device	Package	Shipping
BTA1727L3-0-T3-X	SOT-223 (Pb-free lead plating package)	2500 pcs / tape & reel

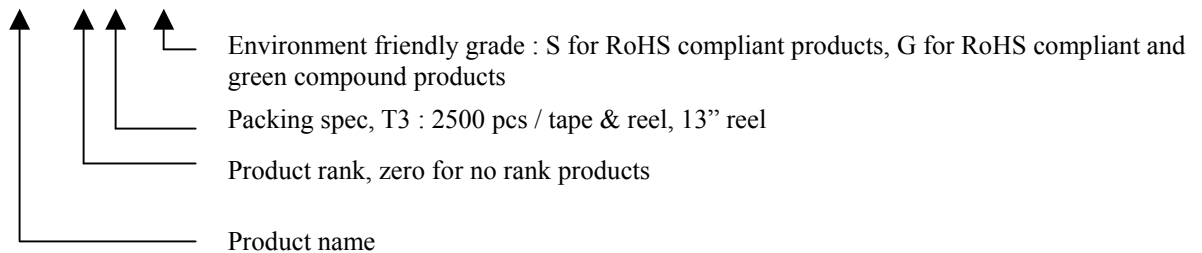



Absolute Maximum Ratings (Ta=25°C)

Parameter	Symbol	Limits	Unit
Collector-Base Voltage	V _{CB0}	-400	V
Collector-Emitter Voltage	V _{CEO}	-400	V
Emitter-Base Voltage	V _{EBO}	-6	V
Collector Current(DC)	I _C	-300	mA
Collector Current(Pulse)	I _{CP}	-1	A
Base Current	I _B	-100	mA
Power Dissipation @Tc=25°C	Pd	5	W
Junction Temperature	Tj	150	°C
Storage Temperature	Tstg	-55~+150	°C

Characteristics (Ta=25°C)

Symbol	Min.	Typ.	Max.	Unit	Test Conditions
BV _{CB0}	-400	-	-	V	I _C =-100μA, I _E =0
BV _{CEO}	-400	-	-	V	I _C =-1mA, I _B =0
BV _{EBO}	-6	-	-	V	I _E =-10μA, I _C =0
I _{CB0}	-	-	-100	nA	V _{CB} =-400V, I _E =0
I _{EBO}	-	-	-100	nA	V _{EB} =-4V, I _C =0
*V _{CE(sat)1}	-	-	-0.3	V	I _C =-10mA, I _B =-1mA
*V _{CE(sat)2}	-	-	-0.5	V	I _C =-50mA, I _B =-5mA
*V _{BE(sat)1}	-	-	-0.8	V	I _C =-10mA, I _B =-1mA
*V _{BE(sat)2}	-	-	-0.95	V	I _C =-50mA, I _B =-5mA
*V _{BE(on)}	-	-	-0.95	V	V _{CE} =-10V, I _C =-50mA
*h _{FE1}	50	-	-	-	V _{CE} =-10V, I _C =-1mA
*h _{FE2}	90	-	260	-	V _{CE} =-10V, I _C =-10mA
*h _{FE3}	90	-	260	-	V _{CE} =-10V, I _C =-50mA
*h _{FE4}	40	-	-	-	V _{CE} =-10V, I _C =-100mA
f _T	-	90	-	MHz	V _{CE} =-5V, I _C =-50mA, f=100MHz
Cob	-	7	-	pF	V _{CB} =-20V, f=1MHz

*Pulse Test : Pulse Width ≤380μs, Duty Cycle ≤2%

Recommended soldering footprint

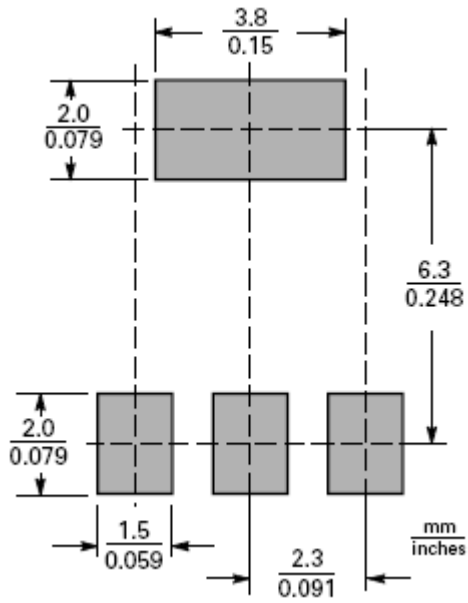

Typical Characteristics

Current Gain vs Collector Current

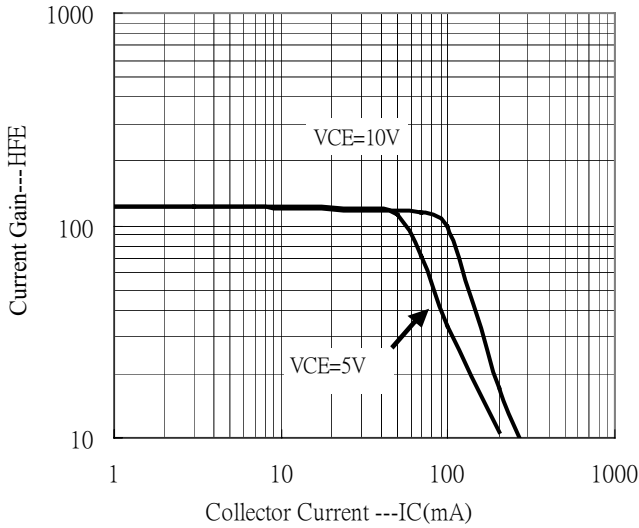

Saturation Voltage vs Collector Current

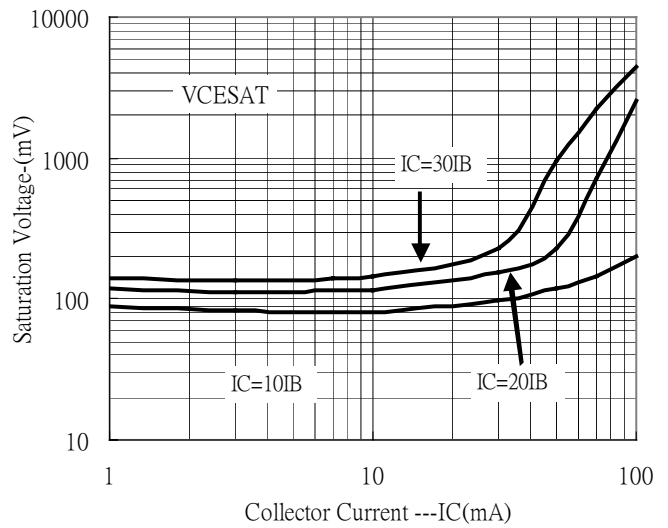

Saturation Voltage vs Collector Current

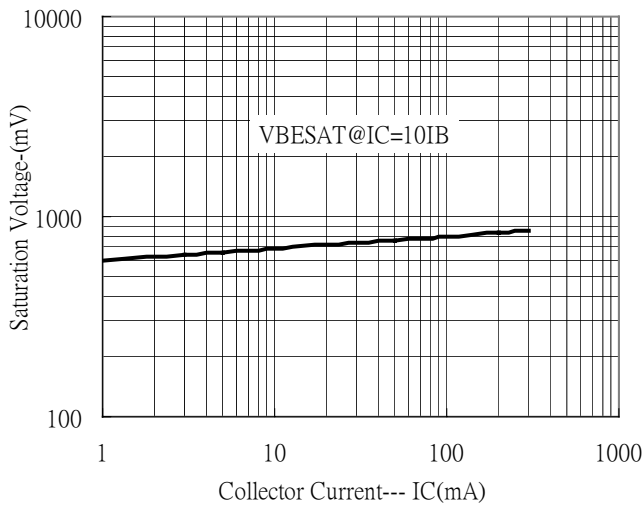

Power Derating Curve

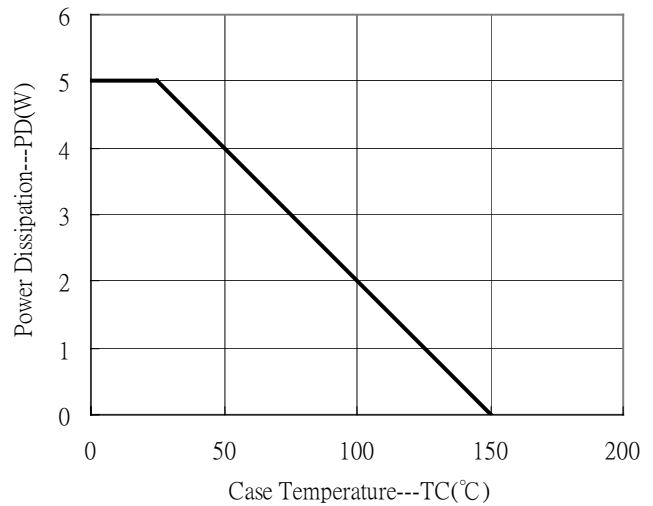

Transition Frequency vs Collector Current

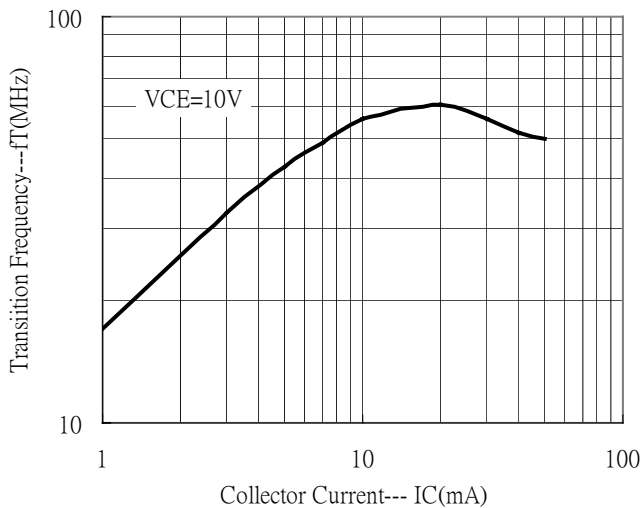

Capacitance Characteristics

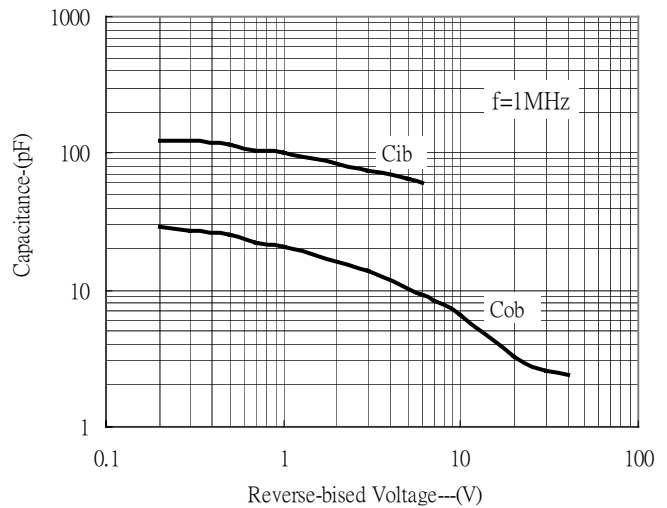

Reel Dimension

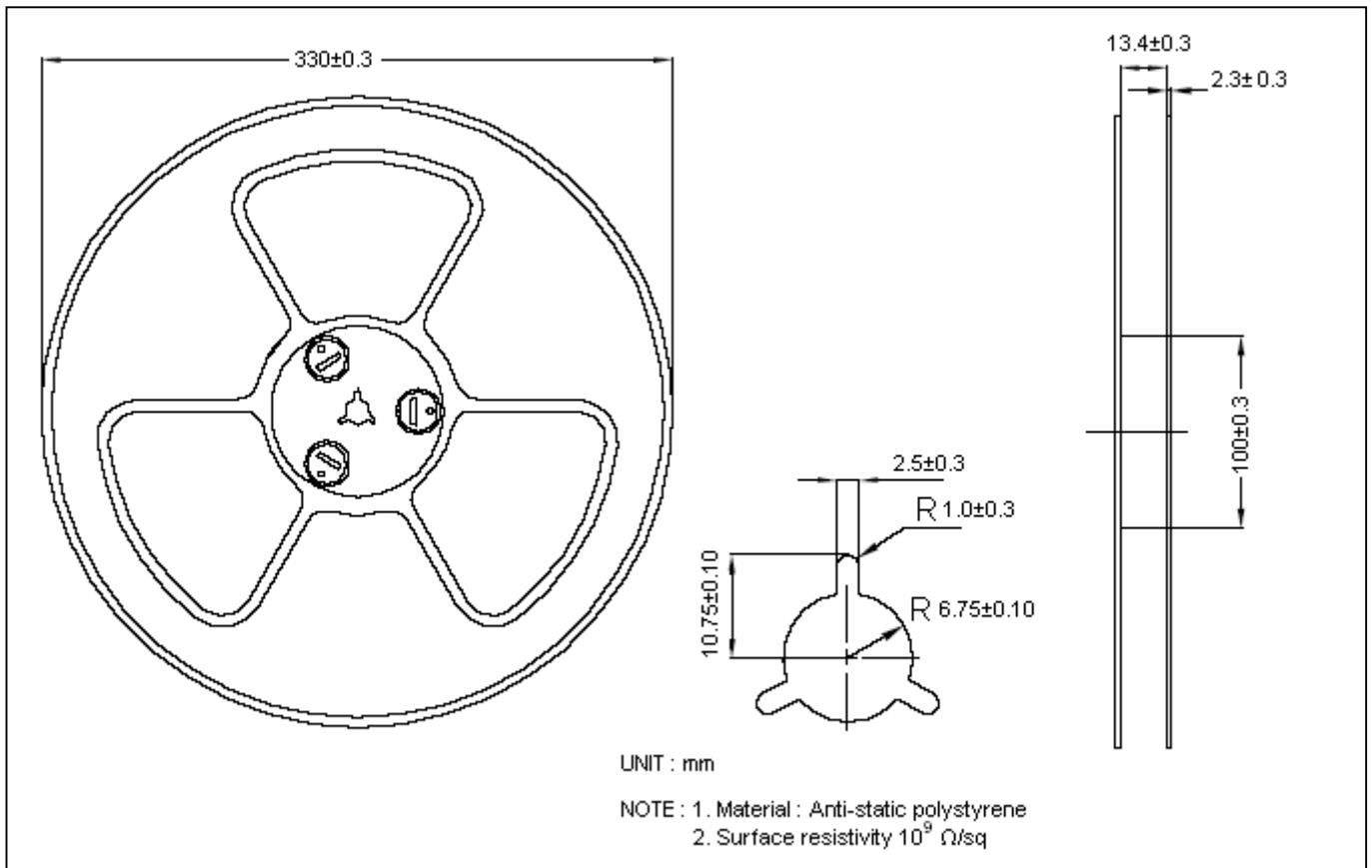

Carrier Tape Dimension

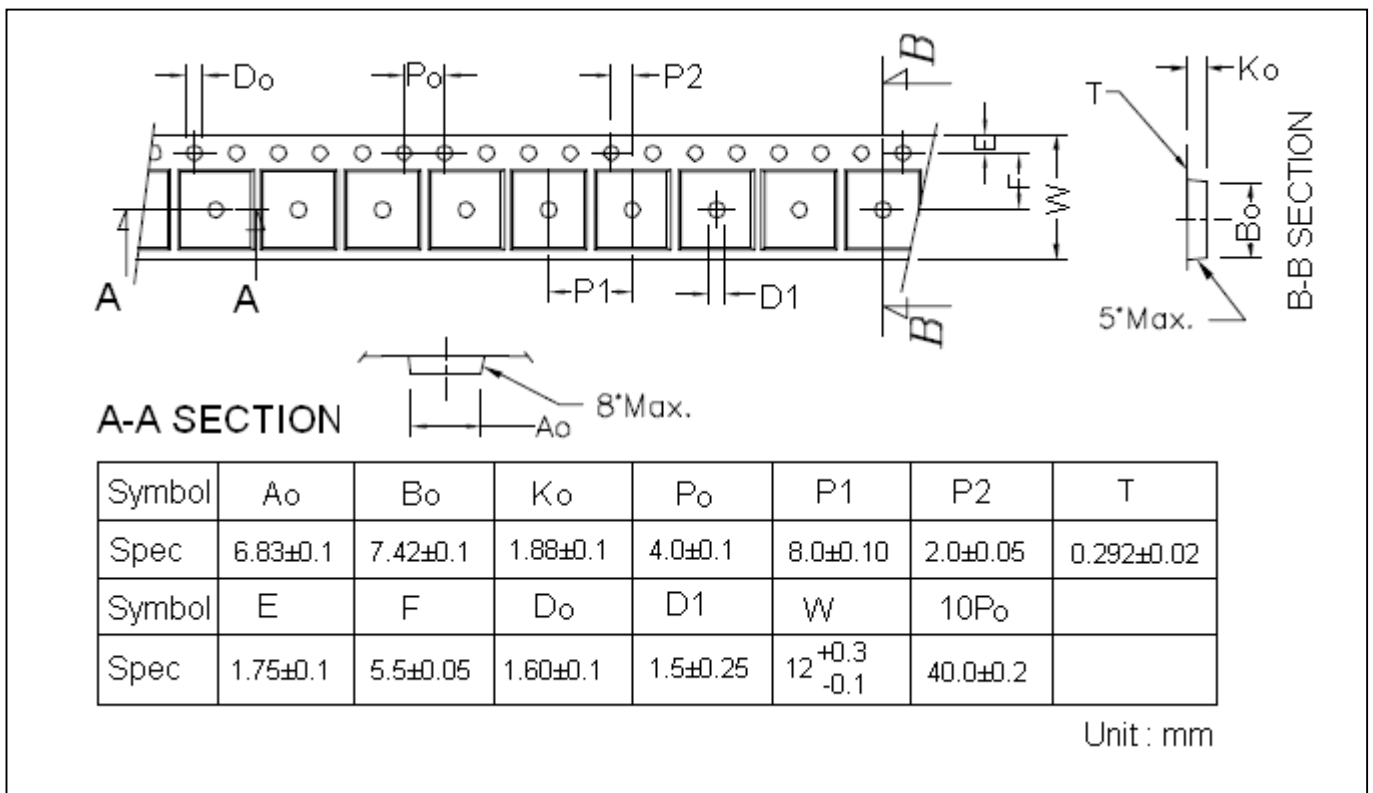

Recommended wave soldering condition

Product	Peak Temperature	Soldering Time
Pb-free devices	260 +0/-5 °C	5 +1/-1 seconds

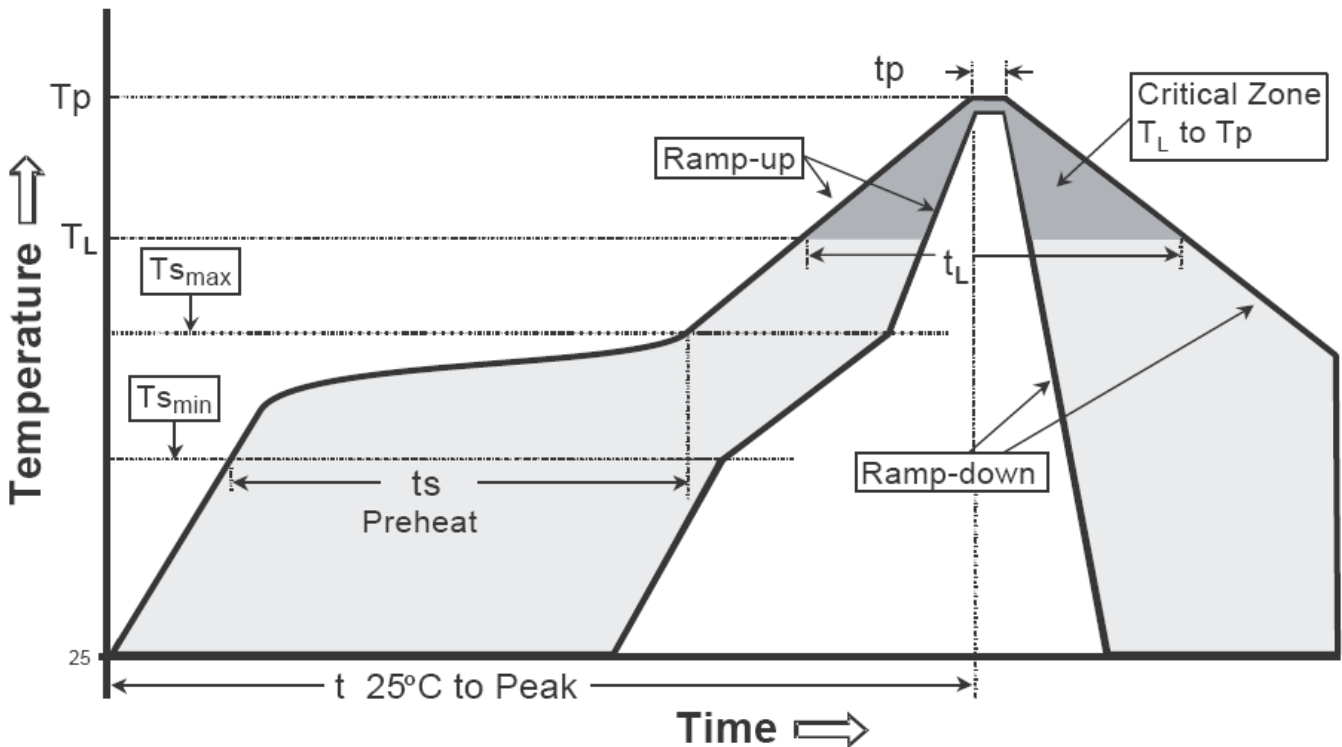
Recommended temperature profile for IR reflow

Profile feature	Sn-Pb eutectic Assembly	Pb-free Assembly
Average ramp-up rate (Tsmax to Tp)	3°C/second max.	3°C/second max.
Preheat		
-Temperature Min(Ts min)	100°C	150°C
-Temperature Max(Ts max)	150°C	200°C
-Time(ts min to ts max)	60-120 seconds	60-180 seconds
Time maintained above:		
-Temperature (TL)	183°C	217°C
- Time (tL)	60-150 seconds	60-150 seconds
Peak Temperature(Tp)	240 +0/-5 °C	260 +0/-5 °C
Time within 5°C of actual peak temperature(tp)	10-30 seconds	20-40 seconds
Ramp down rate	6°C/second max.	6°C/second max.
Time 25 °C to peak temperature	6 minutes max.	8 minutes max.

Note :1. All temperatures refer to topside of the package, measured on the package body surface.
 2. For devices mounted on FR-4 PCB of 1.6mm or equivalent grade PCB. If other grade PCB is used, care should be taken to match the coefficients of thermal expansion between components and PCB. If they are not matched well, the solder joints may crack or the bodies of the parts may crack or shatter as the assembly cools.

SOT-223 Dimension

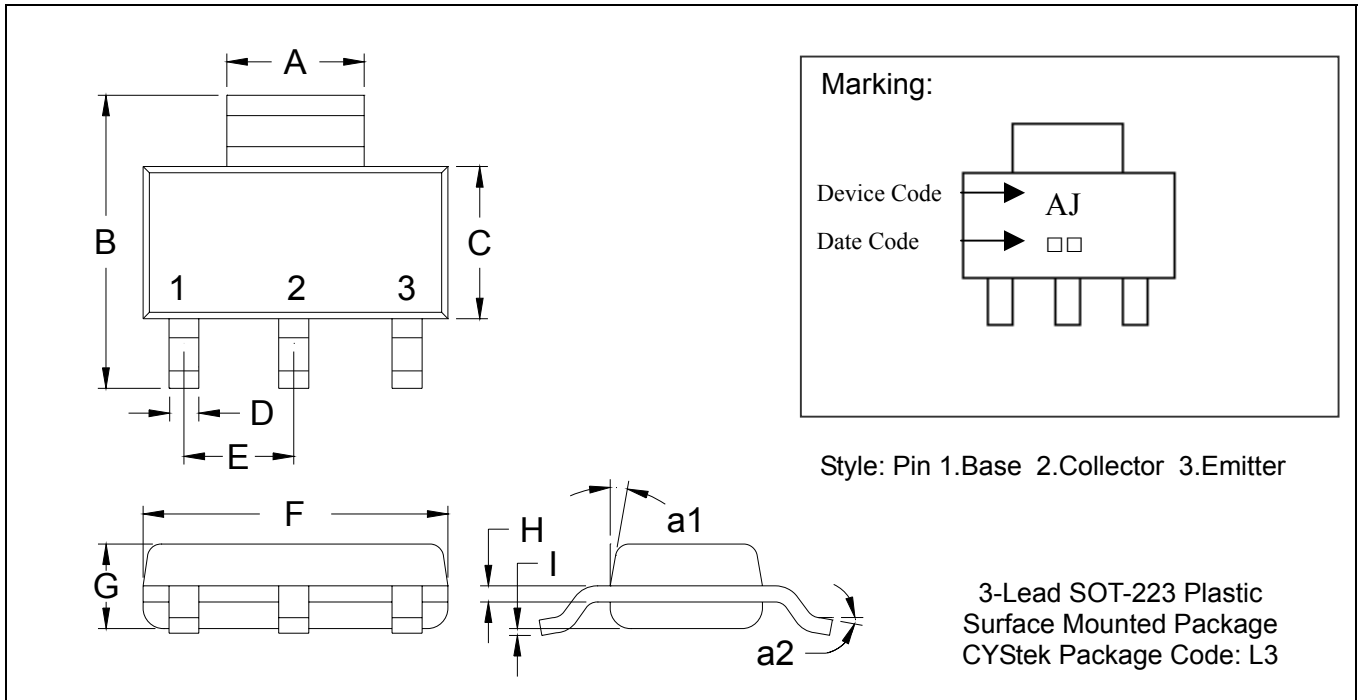

*: Typical

DIM	Inches		Millimeters		DIM	Inches		Millimeters	
	Min.	Max.	Min.	Max.		Min.	Max.	Min.	Max.
A	0.1142	0.1220	2.90	3.10	G	0.0551	0.0709	1.40	1.80
B	0.2638	0.2874	6.70	7.30	H	0.0098	0.0138	0.25	0.35
C	0.1299	0.1457	3.30	3.70	I	0.0008	0.0039	0.02	0.10
D	0.0236	0.0315	0.60	0.80	a1	*13°	-	*13°	-
E	*0.0906	-	*2.30	-	a2	0°	10°	0°	10°
F	0.2480	0.2638	6.30	6.70					

- Notes: 1.Controlling dimension: millimeters.
 2.Maximum lead thickness includes lead finish thickness, and minimum lead thickness is the minimum thickness of base material.
 3.If there is any question with packing specification or packing method, please contact your local CYStek sales office.

Material:

- Lead: Pure tin plated.
- Mold Compound: Epoxy resin family, flammability solid burning class: UL94V-0.

Important Notice:

- All rights are reserved. Reproduction in whole or in part is prohibited without the prior written approval of CYStek.
- CYStek reserves the right to make changes to its products without notice.
- CYStek **semiconductor products are not warranted to be suitable for use in Life-Support Applications, or systems.**
- CYStek assumes no liability for any consequence of customer product design, infringement of patents, or application assistance.