

# PNP Epitaxial Planar Transistor

## BTA1020M3

### Features

- Low  $V_{CE(SAT)}$ ,  $V_{CE(SAT)} = -215mV$  (Typ.) @  $I_C/I_B = -1A/-50mA$
- High breakdown voltage,  $BV_{CEO} = -50V$
- Complementary to BTA2655M3
- Pb-free lead plating and halogen-free package

### Symbol

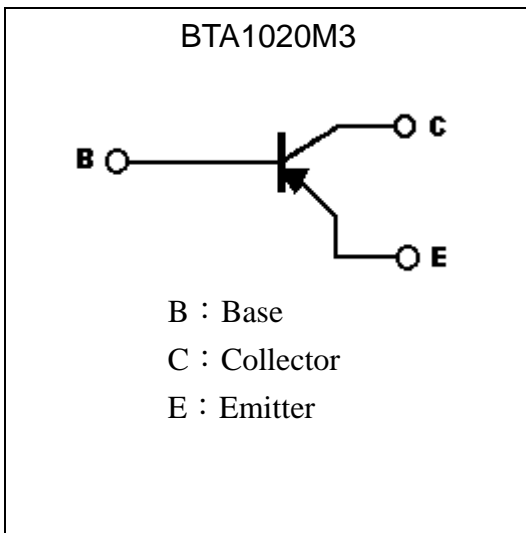

### Outline

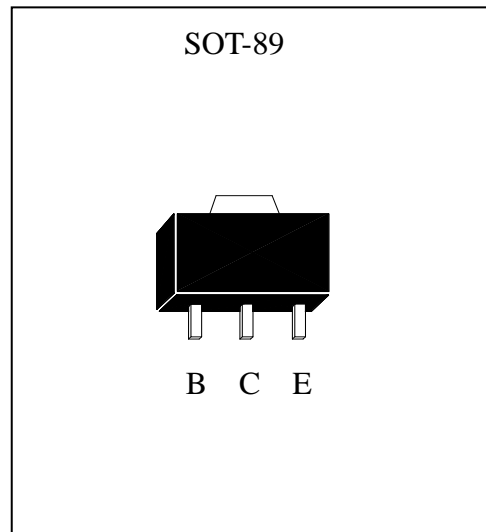

### Ordering Information

Device	Package	Shipping
BTA1020M3-0-T2-G	SOT-89 (Pb-free lead plating and halogen-free package)	1000 pcs / Tape & Reel

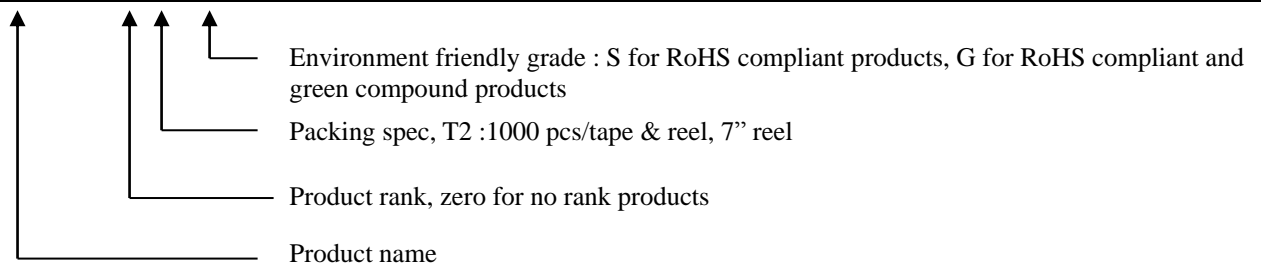



**Absolute Maximum Ratings** (Ta=25°C)

Parameter	Symbol	Limits	Unit
Collector-Base Voltage	V <sub>CB0</sub>	-80	V
Collector-Emitter Voltage	V <sub>CEO</sub>	-50	
Emitter-Base Voltage	V <sub>EBO</sub>	-7	
Collector Current (DC)	I <sub>C</sub>	-2	A
Collector Current (Pulse)	I <sub>CP</sub>	-5 (Note1)	
Power Dissipation	P <sub>D</sub>	0.6	W
		1.5 (Note 2)	
		2 (Note 3)	
Thermal Resistance, Junction to Ambient	R <sub>θJA</sub>	208	°C/W
		83.3 (Note 2)	
		62.5 (Note 3)	
Operating Junction Temperature Range	T <sub>j</sub>	-55~+150	°C
Storage Temperature Range	T <sub>stg</sub>	-55~+150	°C

- Note : 1. Single Pulse Pw ≤ 350μs, Duty ≤ 2%.  
 2. When mounted on FR-4 PCB with area measuring 25×25×1.6 mm.  
 3. When mounted on ceramic with area measuring 40×40×1 mm.

**Characteristics** (Ta=25°C)

Symbol	Min.	Typ.	Max.	Unit	Test Conditions
BV <sub>CB0</sub>	-80	-	-	V	I <sub>C</sub> =-100μA
BV <sub>CEO</sub>	-50	-	-		I <sub>C</sub> =-10mA
BV <sub>EBO</sub>	-7	-	-		I <sub>E</sub> =-10μA
I <sub>CB0</sub>	-	-	-100	nA	V <sub>CB</sub> =-80V
I <sub>EBO</sub>	-	-	-100		V <sub>EB</sub> =-7V
*V <sub>CE(sat)</sub>	-	-43	-180	mV	I <sub>C</sub> =-100mA, I <sub>B</sub> =-5mA
*V <sub>CE(sat)</sub>	-	-215	-450		I <sub>C</sub> =-1A, I <sub>B</sub> =-50mA
*V <sub>BE(sat)</sub>	-	-0.88	-1.2	V	I <sub>C</sub> =-1A, I <sub>B</sub> =-50mA
*h <sub>FE 1</sub>	120	-	240	-	V <sub>CE</sub> =-2V, I <sub>C</sub> =-500mA
*h <sub>FE 2</sub>	70	-	-	-	V <sub>CE</sub> =-2V, I <sub>C</sub> =-1.5A
f <sub>T</sub>	-	110	-	MHz	V <sub>CE</sub> =-2V, I <sub>C</sub> =-500mA, f=100MHz
Cob	-	18	-	pF	V <sub>CB</sub> =-10V, f=1MHz

\*Pulse Test: Pulse Width ≤ 380μs, Duty Cycle ≤ 2%

**Typical Characteristics**

Emitter Grounded Output Characteristics

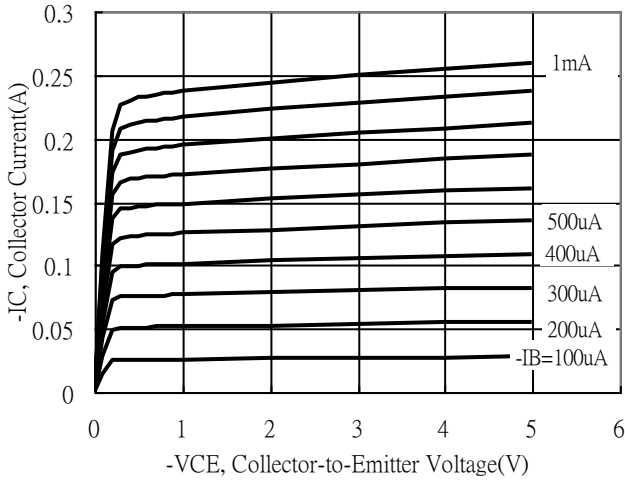

Emitter Grounded Output Characteristics

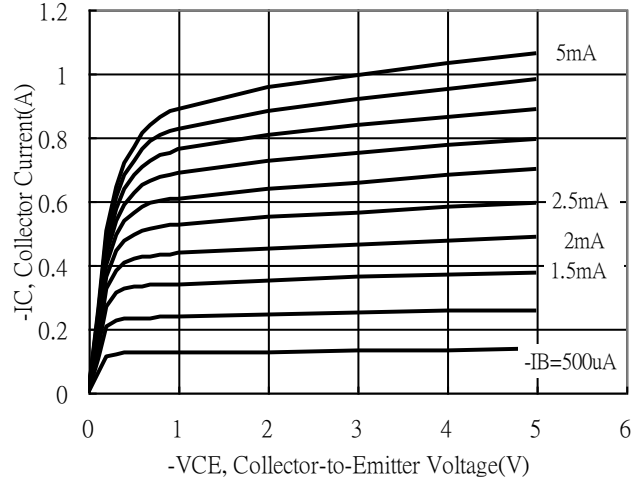

Emitter Grounded Output Characteristics

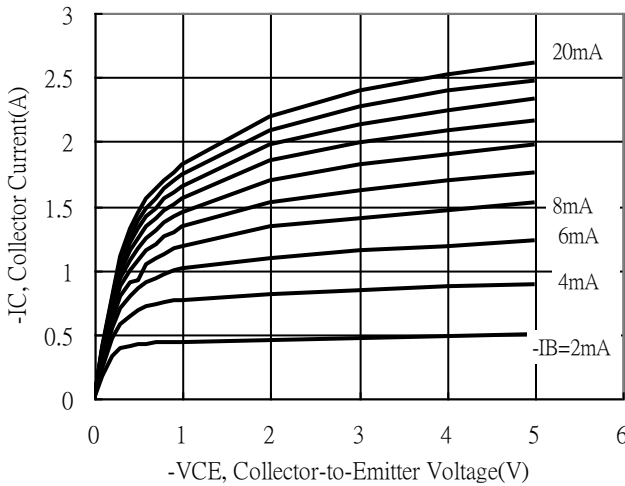

Emitter Grounded Output Characteristics

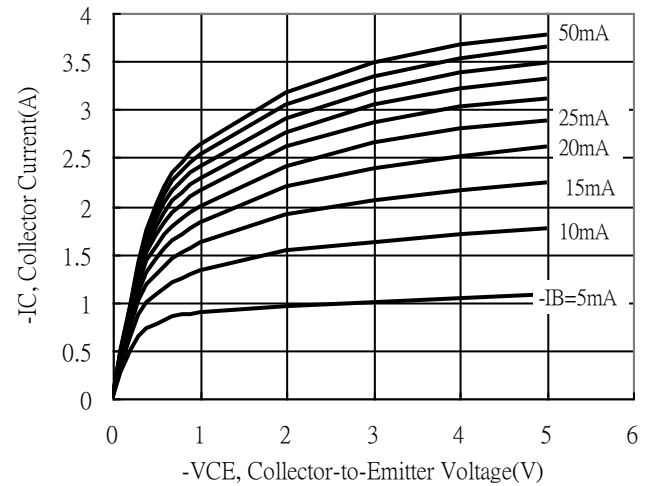

Current Gain vs Collector Current

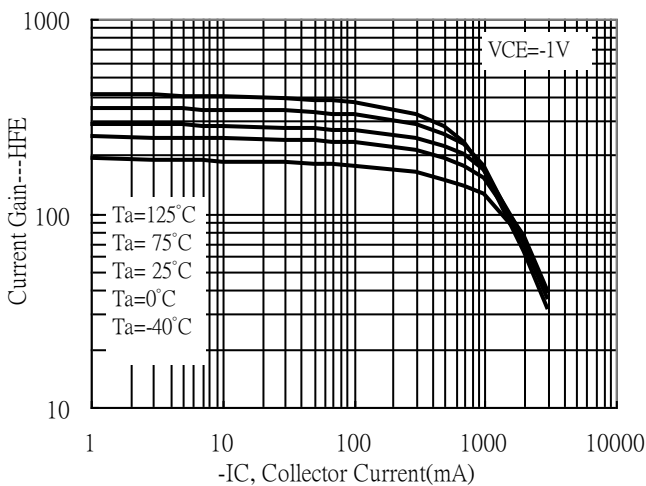

Current Gain vs Collector Current

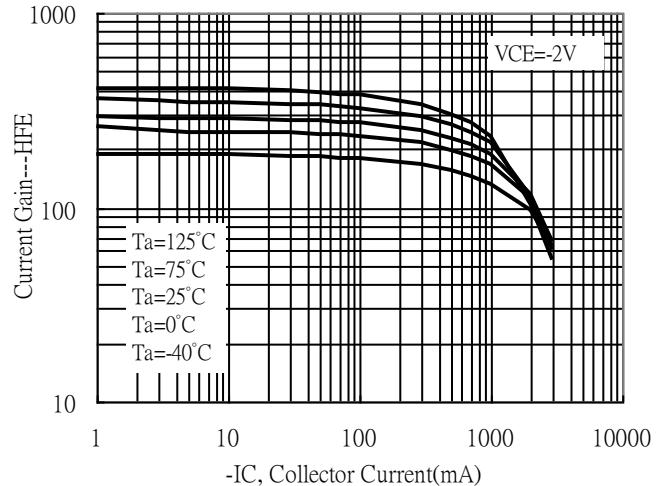

**Typical Characteristics(Cont.)**

Current Gain vs Collector Current

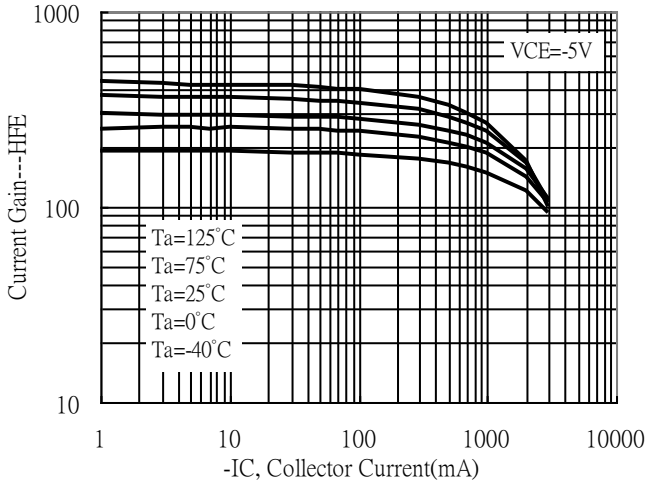

Saturation Voltage vs Collector Current

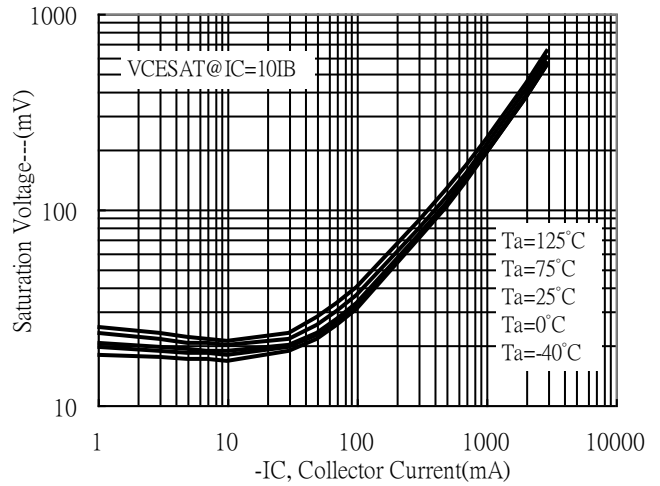

Saturation Voltage vs Collector Current

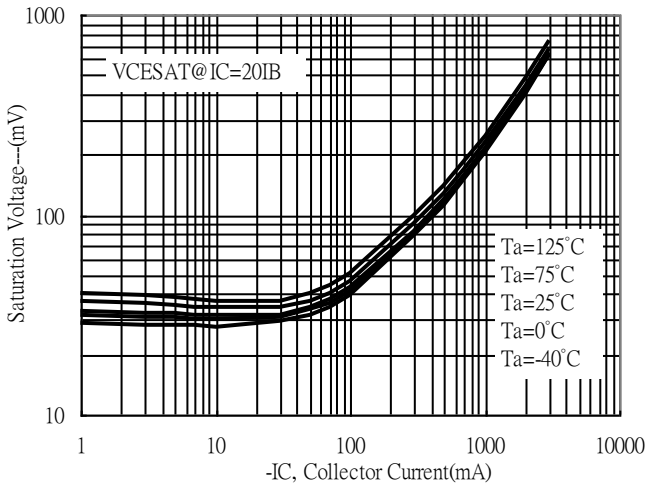

Saturation Voltage vs Collector Current

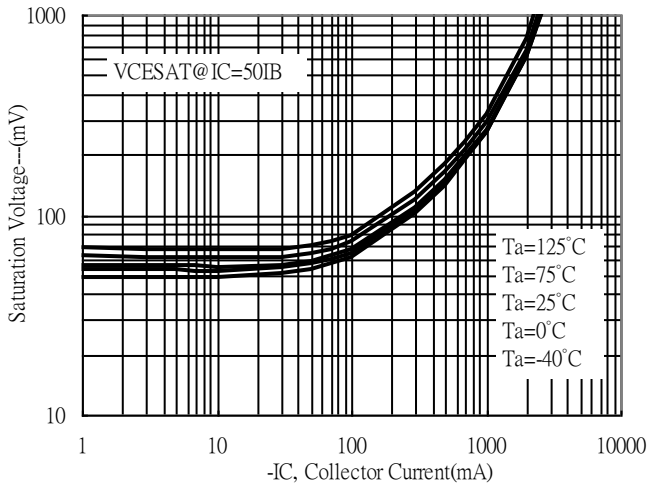

Saturation Voltage vs Collector Current

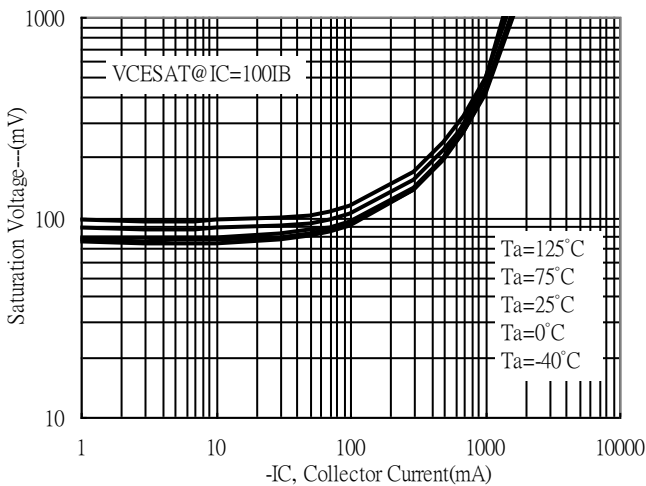

Saturation Voltage vs Collector Current

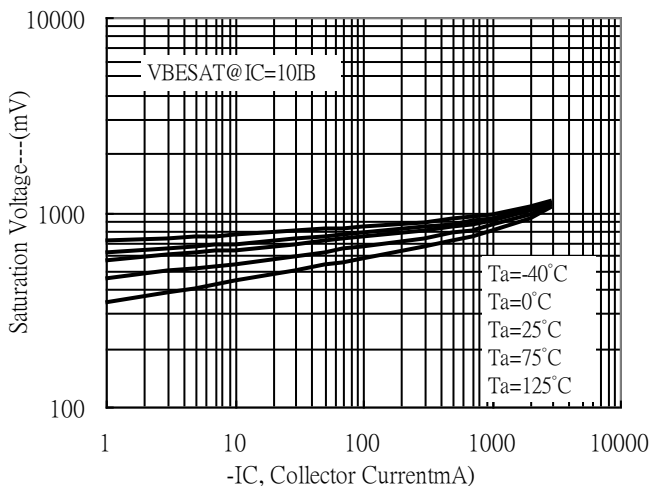

**Typical Characteristics(Cont.)**

On Voltage vs Collector Current

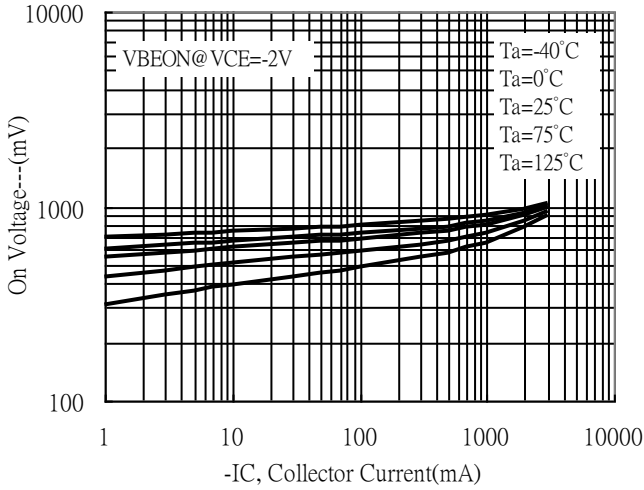

Cutoff Frequency vs Collector Current

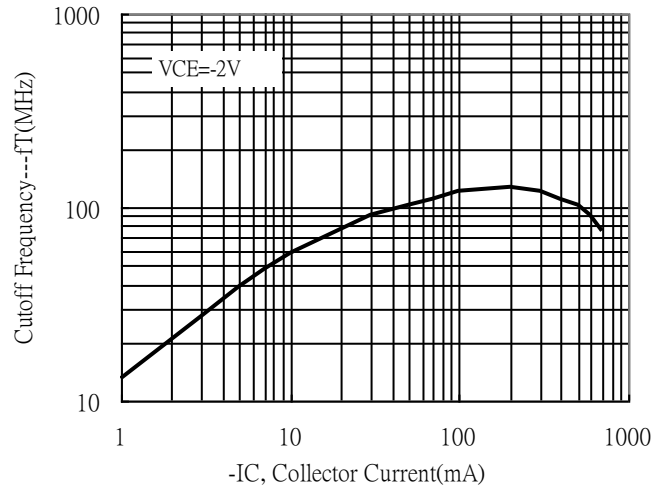

Capacitance vs Reverse-biased Voltage

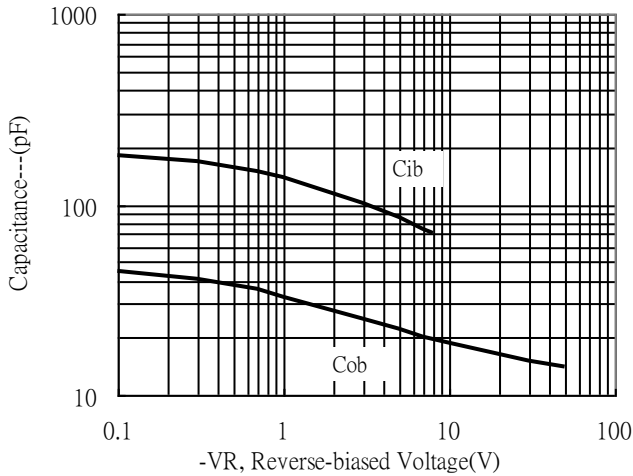

Power Derating Curve

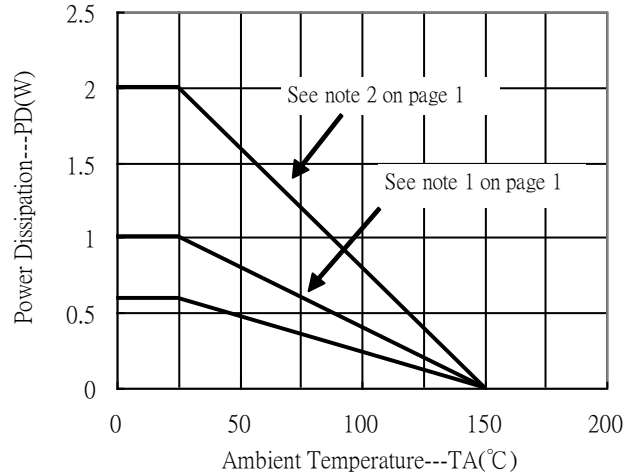

**Recommended soldering footprint**

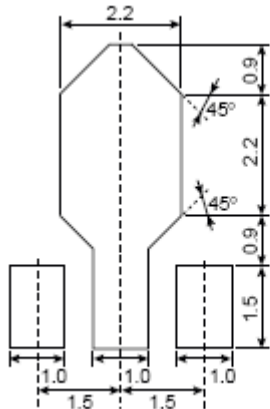

unit : mm

### Reel Dimension

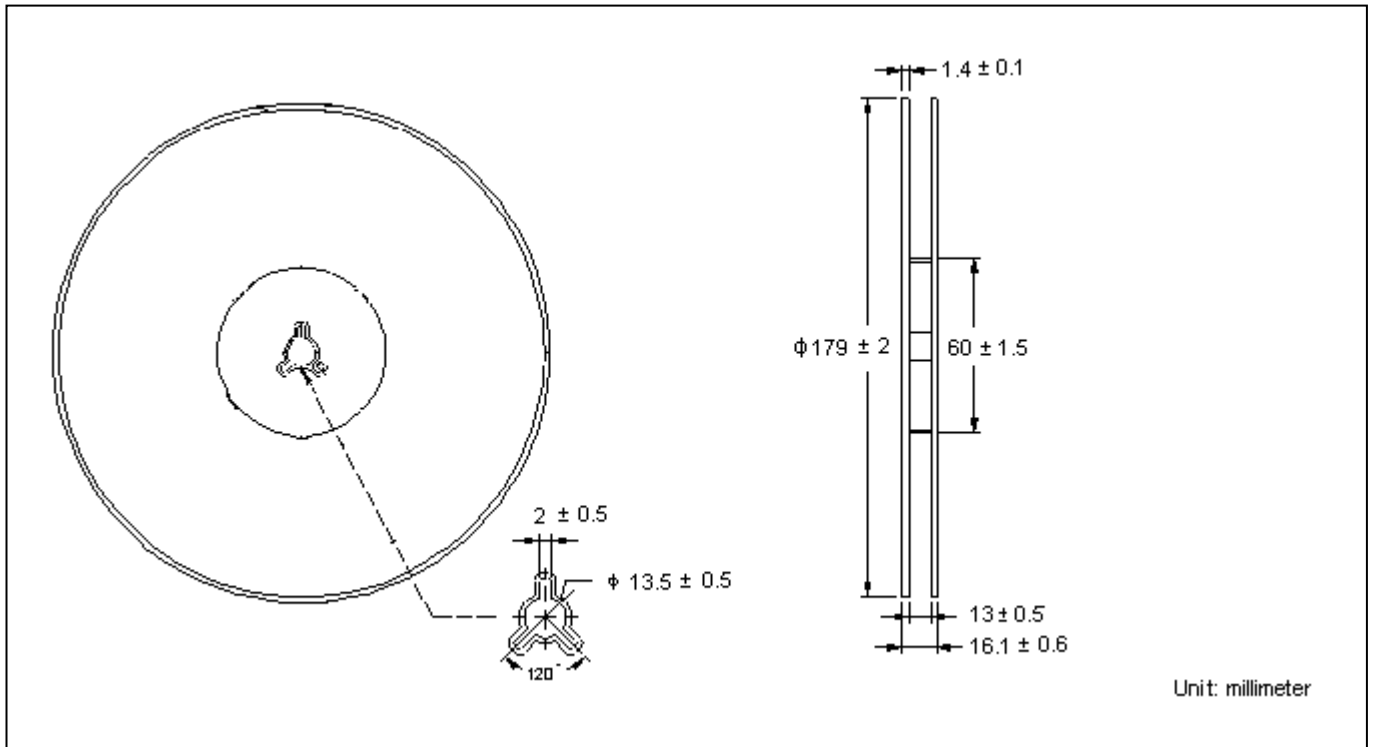

### Carrier Tape Dimension

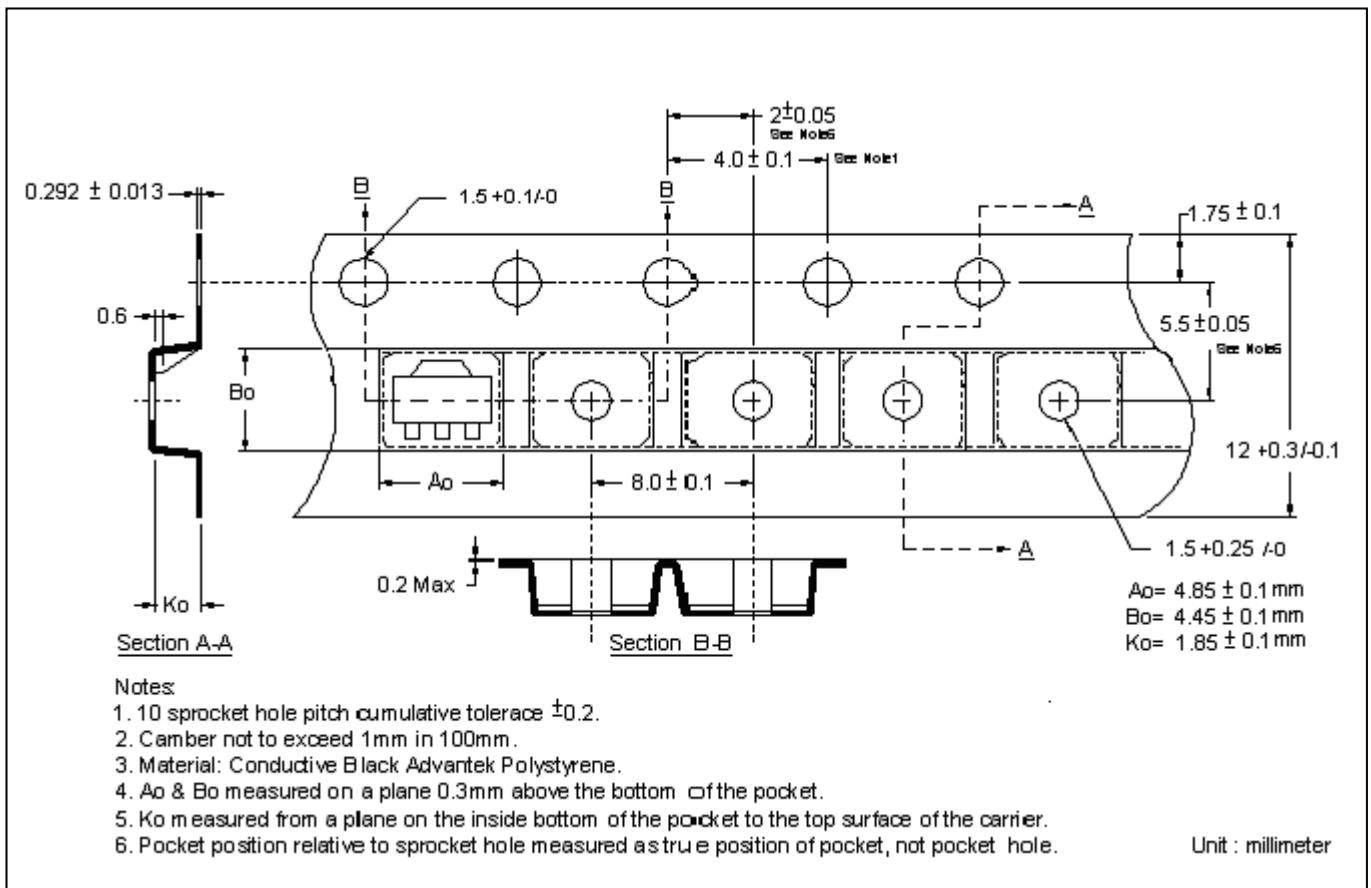

**Recommended wave soldering condition**

Product	Peak Temperature	Soldering Time
Pb-free devices	260 +0/-5 °C	5 +1/-1 seconds

**Recommended temperature profile for IR reflow**

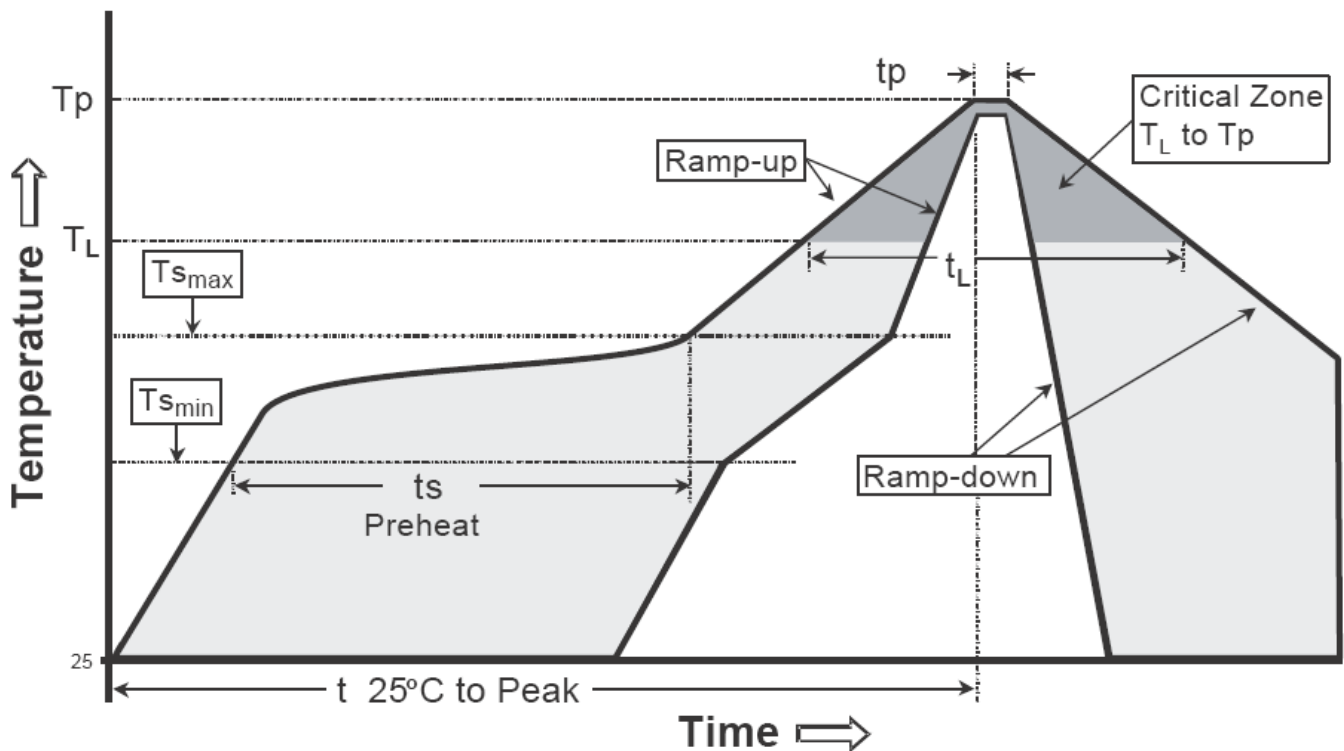

Profile feature	Sn-Pb eutectic Assembly	Pb-free Assembly
Average ramp-up rate (T <sub>smax</sub> to T <sub>p</sub> )	3°C/second max.	3°C/second max.
Preheat		
-Temperature Min(T <sub>s min</sub> )	100°C	150°C
-Temperature Max(T <sub>s max</sub> )	150°C	200°C
-Time(t <sub>s min</sub> to t <sub>s max</sub> )	60-120 seconds	60-180 seconds
Time maintained above:		
-Temperature (T <sub>L</sub> )	183°C	217°C
- Time (t <sub>L</sub> )	60-150 seconds	60-150 seconds
Peak Temperature(T <sub>P</sub> )	240 +0/-5 °C	260 +0/-5 °C
Time within 5°C of actual peak temperature(tp)	10-30 seconds	20-40 seconds
Ramp down rate	6°C/second max.	6°C/second max.
Time 25 °C to peak temperature	6 minutes max.	8 minutes max.

Note : All temperatures refer to topside of the package, measured on the package body surface.

**SOT-89 Dimension**

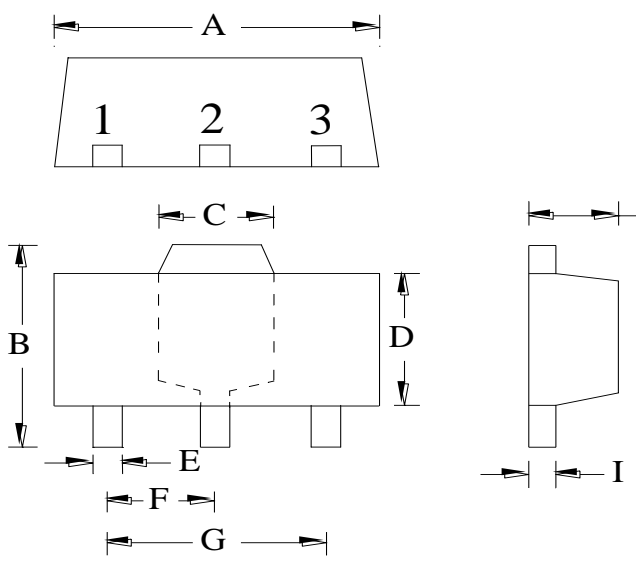

The diagram shows three views of the SOT-89 package: a top view with dimensions A, B, C, D, E, F, and G; a side view with dimensions H and I; and a perspective view with pins labeled 1, 2, and 3.

**Marking:**

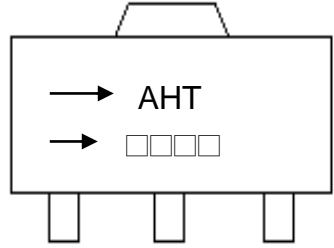

Device Code → AHT  
 Date Code → □□□□

Style: Pin 1. Base 2. Collector 3. Emitter

3-Lead SOT-89 Plastic  
 Surface Mounted Package  
 CYStek Package Code: M3

DIM	Inches		Millimeters		DIM	Inches		Millimeters	
	Min.	Max.	Min.	Max.		Min.	Max.	Min.	Max.
A	0.1732	0.1811	4.40	4.60	F	0.0591	TYP	1.50	TYP
B	0.1551	0.1673	3.94	4.25	G	0.1181	TYP	3.00	TYP
C	0.0610	REF	1.55	REF	H	0.0551	0.0630	1.40	1.60
D	0.0906	0.1024	2.30	2.60	I	0.0138	0.0173	0.35	0.44
E	0.0126	0.0205	0.32	0.52					

**Notes:** 1.Controlling dimension: millimeters.  
 2.Maximum lead thickness includes lead finish thickness, and minimum lead thickness is the minimum thickness of base material.  
 3.If there is any question with packing specification or packing method, please contact your local CYStek sales office.

**Material:**

- Lead: Pure tin plated.
- Mold Compound: Epoxy resin family, flammability solid burning class: UL94V-0.

**Important Notice:**

- All rights are reserved. Reproduction in whole or in part is prohibited without the prior written approval of CYStek.
- CYStek reserves the right to make changes to its products without notice.
- CYStek **semiconductor products are not warranted to be suitable for use in Life-Support Applications, or systems.**
- CYStek assumes no liability for any consequence of customer product design, infringement of patents, or application assistance.