

500mW Zener Diode Series

ZD5229ASH thru ZD5267ASH

Description

The ZD5229ASH thru ZD5267ASH series covers zener voltage range from 4.3V to 75V, and is encapsulated in SOD-123 package, very suitable for low cost, low power voltage regulation application.

Features

- V_Z tolerance : $\pm 2\%$
- Ultra small surface mount package
- General purpose, medium current
- Planar die construction
- Pb-free lead plating and halogen-free package

Symbol

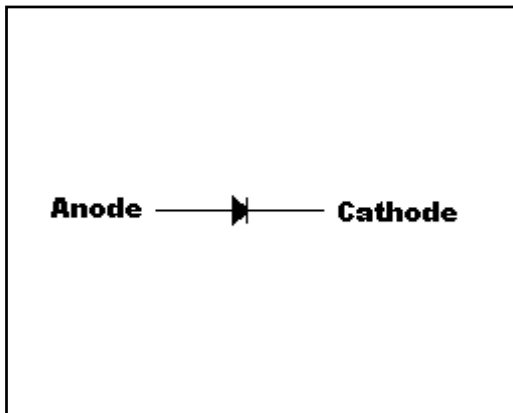

Outline

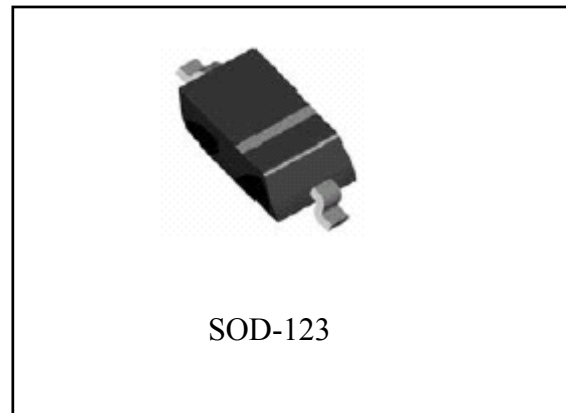

Ordering Information

| Device | Package | Shipping |
|------------------|--|------------------------|
| ZD52XXASH-0-T1-G | SOD-123 (Pb-free lead plating and halogen-free package) | 3000 pcs / tape & reel |

- ↑ Environment friendly grade : S for RoHS compliant products, G for RoHS compliant and green compound products
- ↑ Packing spec, T1 : 3000 pcs / tape & reel, 7" reel
- ↑ Product rank, zero for no rank products
- ↑ Product name



Absolute Maximum Ratings(Tj=25°C, unless otherwise specified)

- Maximum Temperatures
 Operating and Storage Temperature Range Tj, Tstg -65~+150 °C
- Maximum Forward Voltage @ If=10mA0.9V
- Maximum Power Dissipation
 Total Power Dissipation @TA=25 °C Ptot (Note 1)500 mW
- Thermal Resistance, Junction to Ambient RθJA250°C/W
 Thermal Resistance, Junction to Case RθJC150°C/W
- Maximum Z-current..... Ptot/Vz mA

Note : 1. Parts mounted on FR-5 board with area of 1inch × 1inch.

Electrical Characteristic (Ta=25°C, unless otherwise noted)

| Device | Type Code | Nom. Zener Voltage | | | Max. Zener Impedance | | | | Max. Zener Current | Max. Reverse Leakage Current | |
|---------|-----------|--------------------|-------|-------|----------------------|------|------|------|--------------------|------------------------------|-----|
| | | Vz@IzT (V) | | | ZzT | IzT | ZzK | IzK | IzM@Ta | IR | VR |
| | | Nom. | Min. | Max. | (Ω) | (mA) | (Ω) | (mA) | (mA) | (μA) | (V) |
| ZD5229A | G4 | 4.3 | 4.21 | 4.39 | 22 | 20 | 2000 | 0.25 | 106 | 5.0 | 1.0 |
| ZD5230A | G5 | 4.7 | 4.61 | 4.79 | 19 | 20 | 1900 | 0.25 | 97 | 5.0 | 2.0 |
| ZD5231A | E1 | 5.1 | 5.00 | 5.20 | 17 | 20 | 1600 | 0.25 | 89 | 5.0 | 2.0 |
| ZD5232A | E2 | 5.6 | 5.49 | 5.71 | 11 | 20 | 1600 | 0.25 | 81 | 5.0 | 3.0 |
| ZD5233A | E3 | 6.0 | 5.88 | 6.12 | 7.0 | 20 | 1600 | 0.25 | 76 | 5.0 | 3.5 |
| ZD5234A | E4 | 6.2 | 6.08 | 6.32 | 7.0 | 20 | 1000 | 0.25 | 73 | 5.0 | 4.0 |
| ZD5235A | E5 | 6.8 | 6.66 | 6.94 | 5.0 | 20 | 750 | 0.25 | 67 | 3.0 | 5.0 |
| ZD5236A | F1 | 7.5 | 7.35 | 7.65 | 6.0 | 20 | 500 | 0.25 | 61 | 3.0 | 6.0 |
| ZD5237A | F2 | 8.2 | 8.04 | 8.36 | 8.0 | 20 | 500 | 0.25 | 55 | 3.0 | 6.5 |
| ZD5238A | F3 | 8.7 | 8.53 | 8.87 | 8.0 | 20 | 600 | 0.25 | 55 | 3.0 | 6.5 |
| ZD5239A | F4 | 9.1 | 8.92 | 9.28 | 10 | 20 | 600 | 0.25 | 50 | 3.0 | 7.0 |
| ZD5240A | F5 | 10 | 9.80 | 10.20 | 17 | 20 | 600 | 0.25 | 45 | 3.0 | 8.0 |
| ZD5241A | H1 | 11 | 10.78 | 11.22 | 22 | 20 | 600 | 0.25 | 41 | 2.0 | 8.4 |
| ZD5242A | H2 | 12 | 11.76 | 12.24 | 30 | 20 | 600 | 0.25 | 38 | 1.0 | 9.1 |
| ZD5243A | H3 | 13 | 12.74 | 13.26 | 13 | 9.5 | 600 | 0.25 | 35 | 0.5 | 9.9 |
| ZD5245A | H5 | 15 | 14.70 | 15.30 | 16 | 8.5 | 600 | 0.25 | 30 | 0.1 | 11 |
| ZD5246A | J1 | 16 | 15.68 | 16.32 | 17 | 7.8 | 600 | 0.25 | 28 | 0.1 | 12 |
| ZD5248A | J3 | 18 | 17.64 | 18.36 | 21 | 7.0 | 600 | 0.25 | 25 | 0.1 | 14 |
| ZD5250A | J5 | 20 | 19.60 | 20.40 | 25 | 6.2 | 600 | 0.25 | 23 | 0.1 | 15 |
| ZD5251A | K1 | 22 | 21.56 | 22.44 | 29 | 5.6 | 600 | 0.25 | 21 | 0.1 | 17 |
| ZD5252A | K2 | 24 | 23.52 | 24.48 | 33 | 5.2 | 600 | 0.25 | 19.1 | 0.1 | 18 |
| ZD5254A | K4 | 27 | 26.46 | 27.54 | 41 | 5.0 | 600 | 0.25 | 16.8 | 0.1 | 21 |
| ZD5255A | K5 | 28 | 27.44 | 28.56 | 44 | 4.5 | 600 | 0.25 | 16.2 | 0.1 | 21 |
| ZD5256A | M1 | 30 | 29.40 | 30.60 | 49 | 4.2 | 600 | 0.25 | 15.1 | 0.1 | 23 |
| ZD5257A | M2 | 33 | 32.34 | 33.66 | 58 | 3.8 | 700 | 0.25 | 13.8 | 0.1 | 25 |
| ZD5258A | M3 | 36 | 35.28 | 36.72 | 70 | 3.4 | 700 | 0.25 | 12.6 | 0.1 | 27 |
| ZD5259A | M4 | 39 | 38.22 | 39.78 | 80 | 3.2 | 800 | 0.25 | 11.6 | 0.1 | 30 |



| | | | | | | | | | | | |
|---------|----|----|-------|-------|-----|-----|------|------|------|-----|----|
| ZD5260A | M5 | 43 | 42.14 | 43.86 | 93 | 3 | 900 | 0.25 | 10.6 | 0.1 | 33 |
| ZD5261A | N1 | 47 | 46.06 | 47.94 | 105 | 2.7 | 1000 | 0.25 | 9.6 | 0.1 | 36 |
| ZD5262A | N2 | 51 | 49.98 | 52.02 | 125 | 2.5 | 1100 | 0.25 | 8.8 | 0.1 | 39 |
| ZD5263A | N3 | 56 | 54.88 | 57.12 | 150 | 2.2 | 1300 | 0.25 | 8.0 | 0.1 | 43 |
| ZD5264A | N4 | 60 | 58.8 | 61.2 | 170 | 2.1 | 1400 | 0.25 | 7.5 | 0.1 | 46 |
| ZD5265A | N5 | 62 | 60.76 | 63.24 | 185 | 2.0 | 1400 | 0.25 | 7.3 | 0.1 | 47 |
| ZD5266A | P1 | 68 | 66.64 | 69.36 | 230 | 1.8 | 1600 | 0.25 | 6.6 | 0.1 | 52 |
| ZD5267A | P2 | 75 | 73.5 | 76.5 | 270 | 1.7 | 1700 | 0.25 | 6.0 | 0.1 | 56 |

Recommended Soldering Footprint

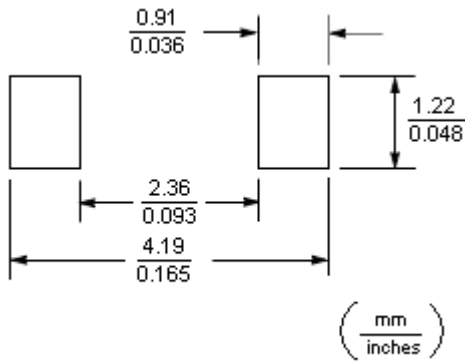



Typical Characteristics

Typical Temperature Coefficient

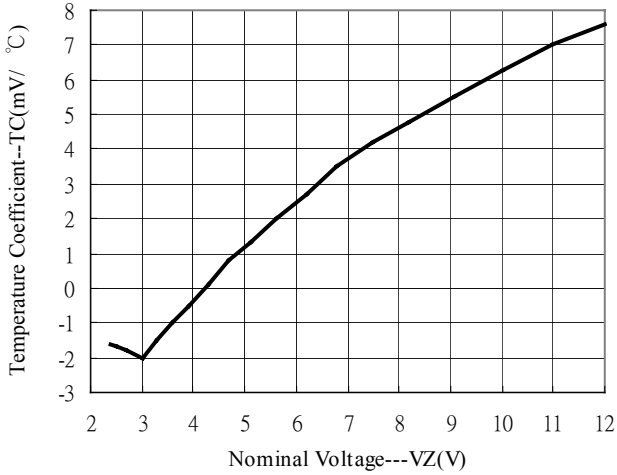

Dynamic Impedance

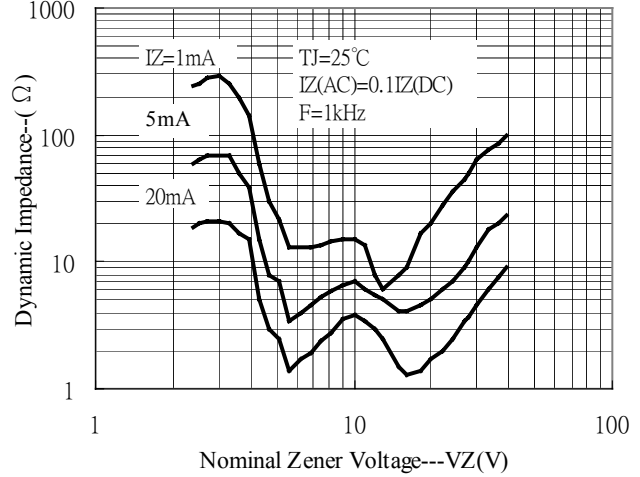

Typical Capacitance

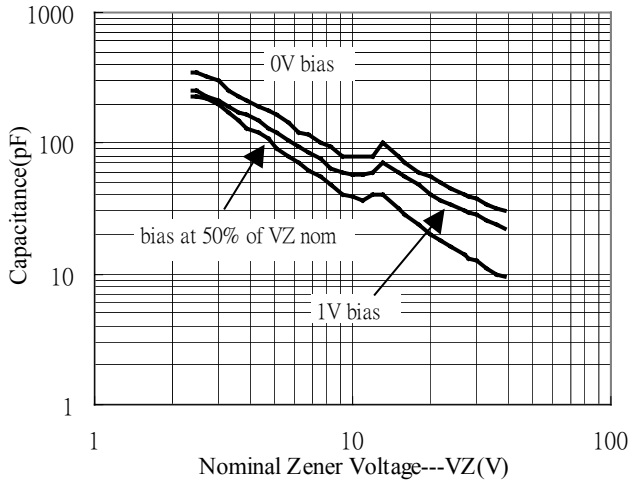

Power Derating Curve

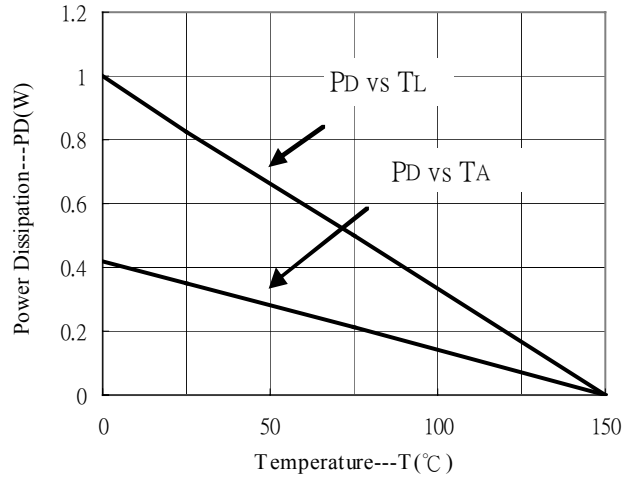

Zener Current vs Zener Voltage

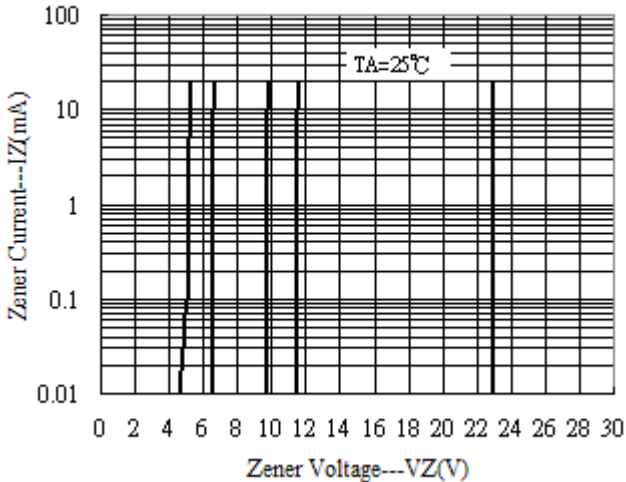

Typical Leakage Current

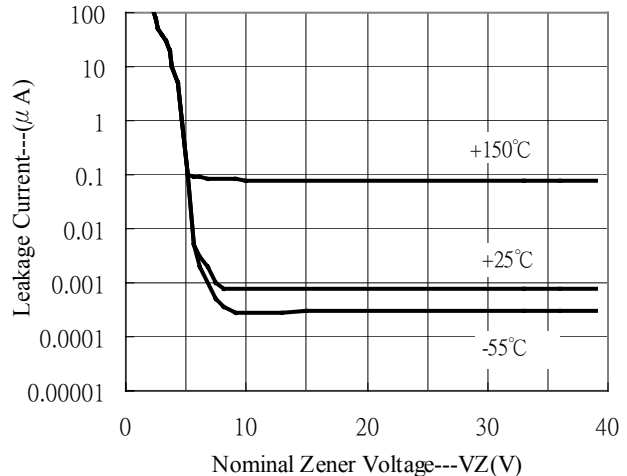

Reel Dimension

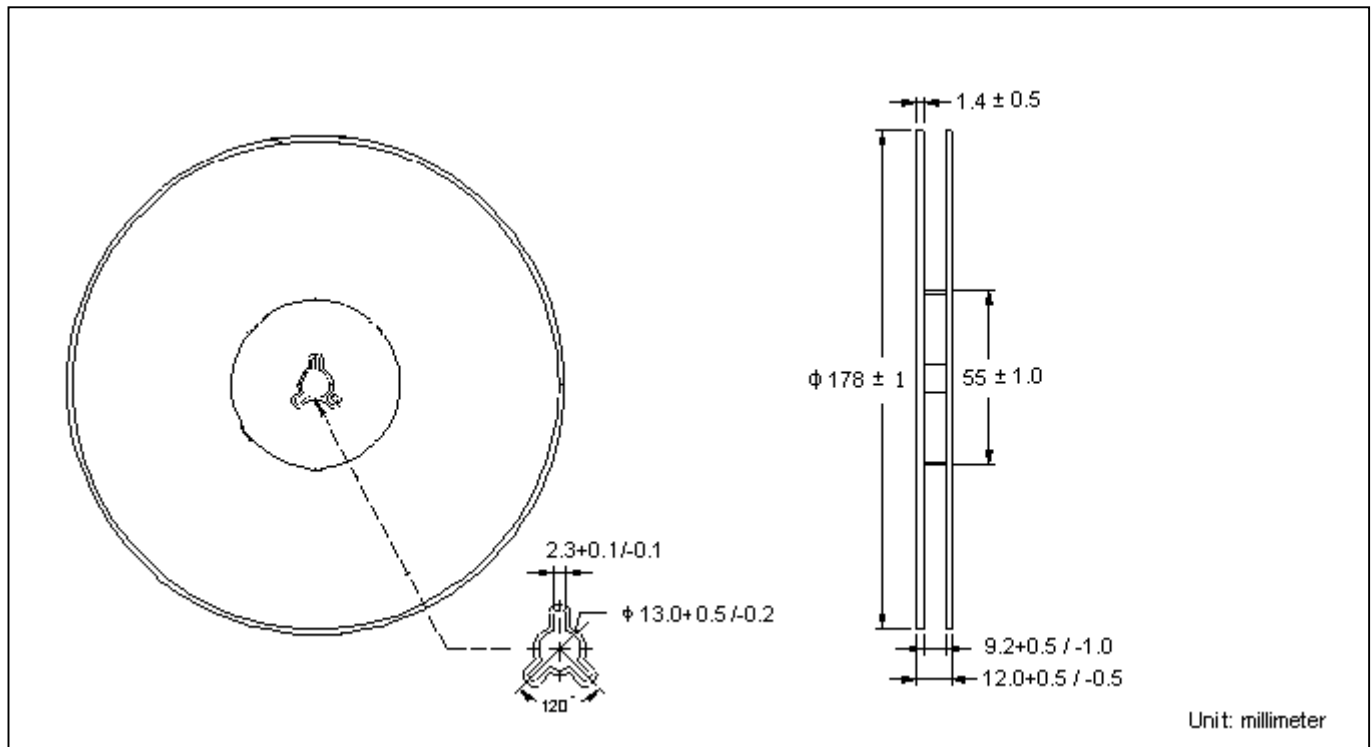

Carrier Tape Dimension

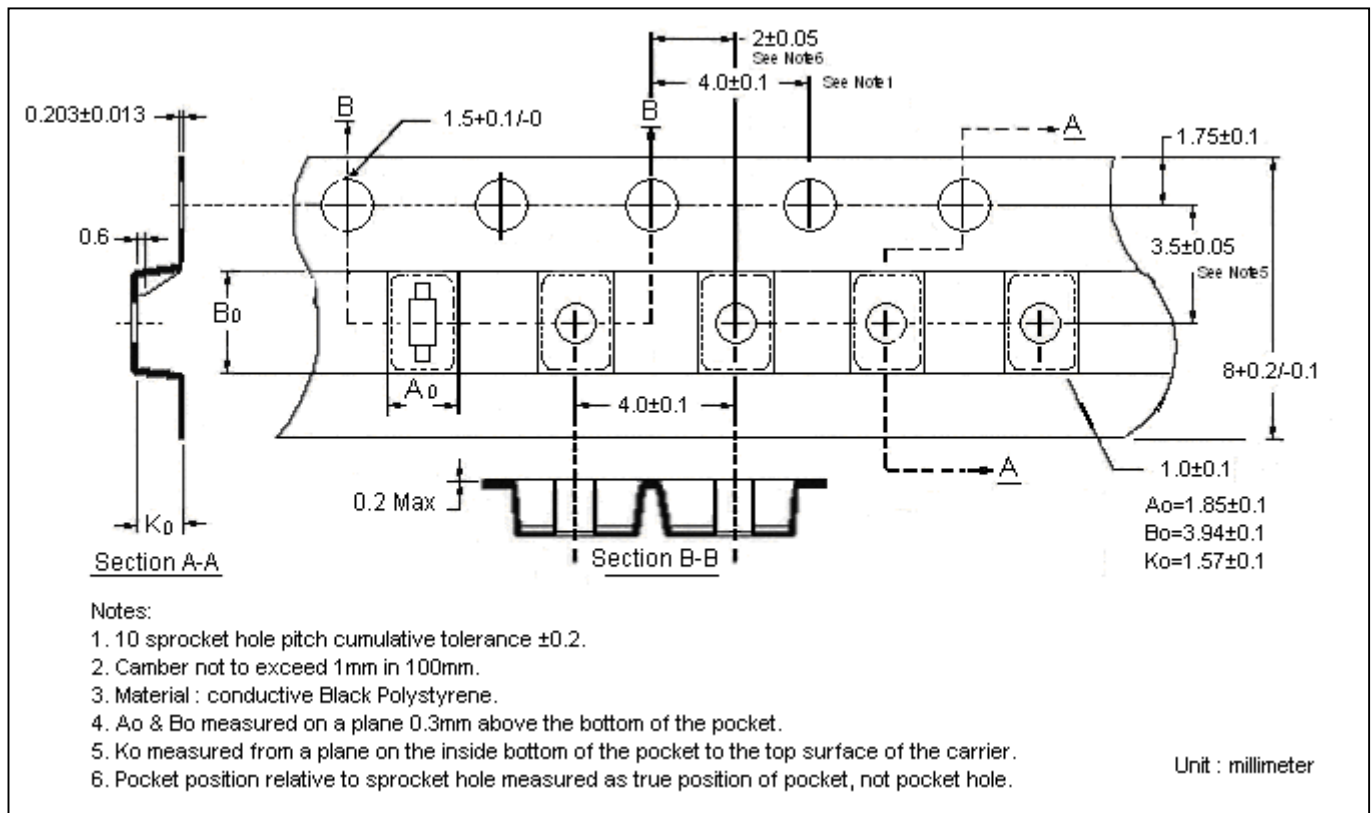

Recommended wave soldering condition

| | | |
|-----------------|------------------|-----------------|
| Product | Peak Temperature | Soldering Time |
| Pb-free devices | 260 +0/-5 °C | 5 +1/-1 seconds |

Recommended temperature profile for IR reflow

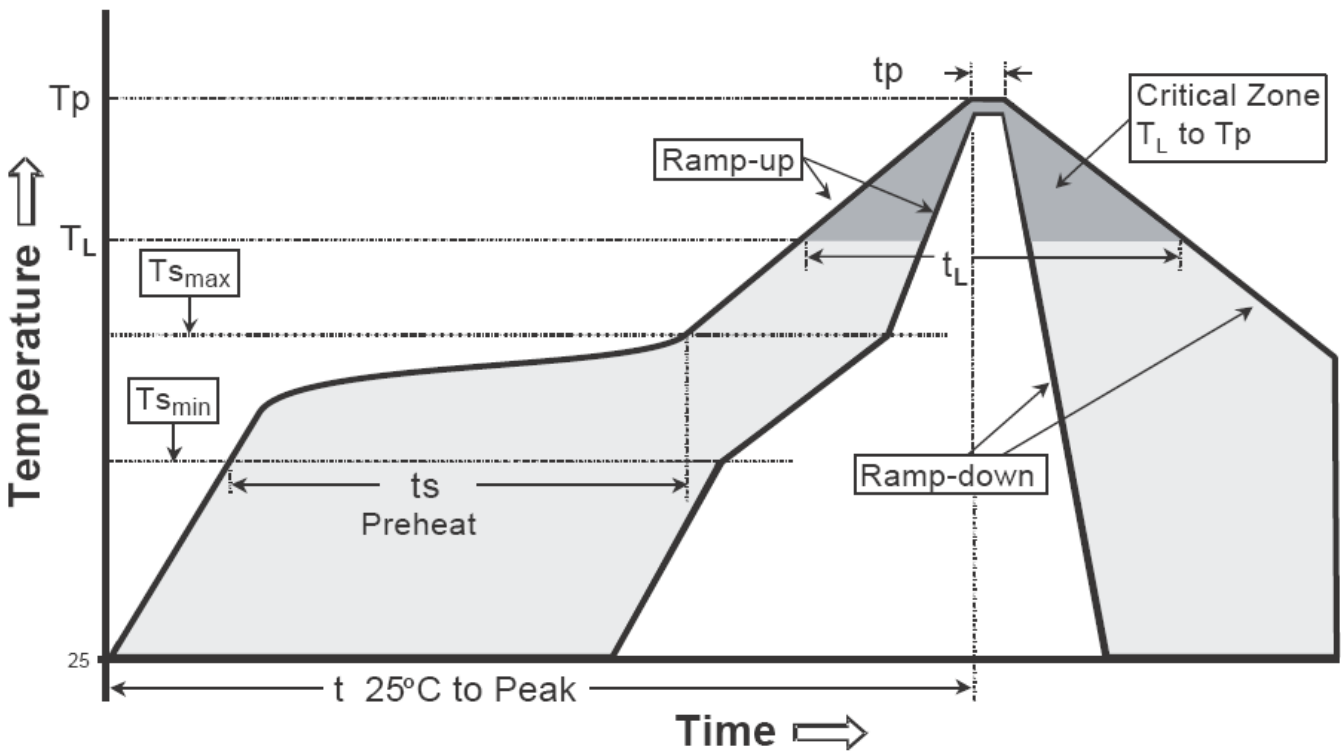

| Profile feature | Sn-Pb eutectic Assembly | Pb-free Assembly |
|--|-------------------------|------------------|
| Average ramp-up rate (Tsmax to Tp) | 3°C/second max. | 3°C/second max. |
| Preheat | | |
| -Temperature Min(Ts min) | 100°C | 150°C |
| -Temperature Max(Ts max) | 150°C | 200°C |
| -Time(ts min to ts max) | 60-120 seconds | 60-180 seconds |
| Time maintained above: | | |
| -Temperature (TL) | 183°C | 217°C |
| - Time (tL) | 60-150 seconds | 60-150 seconds |
| Peak Temperature(TP) | 240 +0/-5 °C | 260 +0/-5 °C |
| Time within 5°C of actual peak temperature(tp) | 10-30 seconds | 20-40 seconds |
| Ramp down rate | 6°C/second max. | 6°C/second max. |
| Time 25 °C to peak temperature | 6 minutes max. | 8 minutes max. |

Note : All temperatures refer to topside of the package, measured on the package body surface.

SOD-123 Dimension

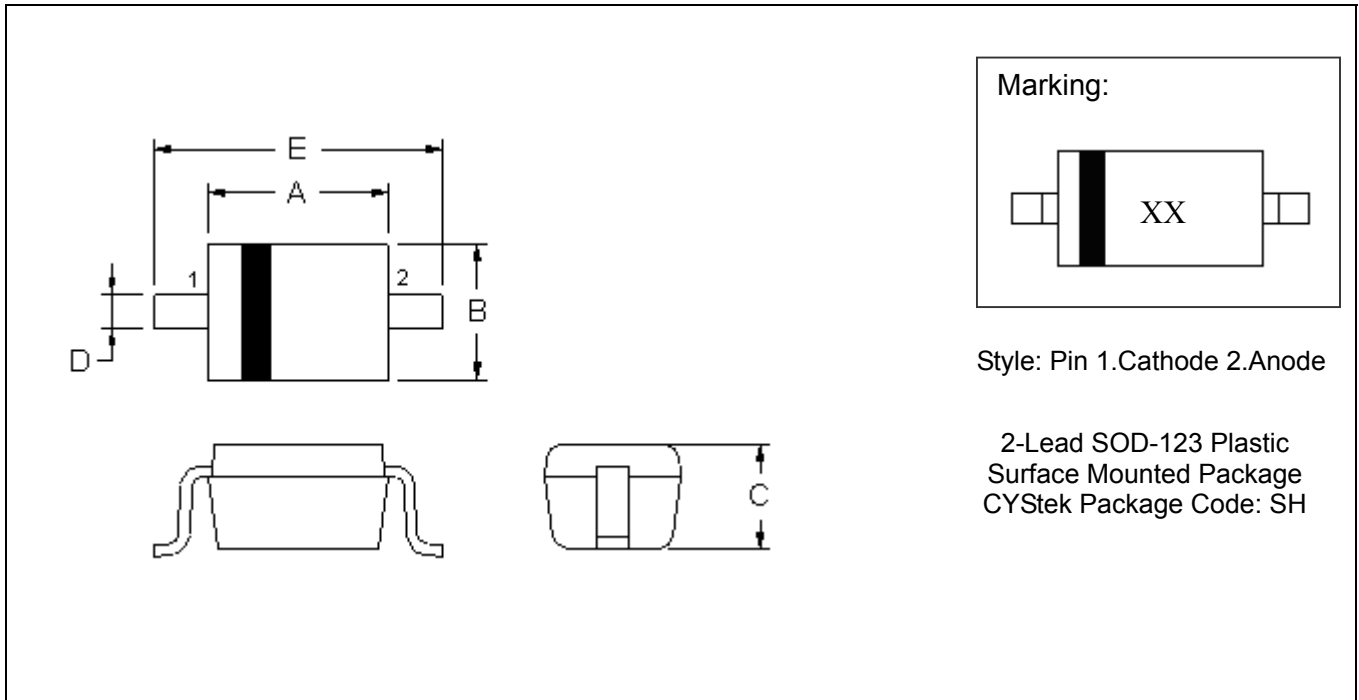

*: Typical

| DIM | Inches | | Millimeters | | DIM | Inches | | Millimeters | |
|-----|--------|-------|-------------|-------|-----|--------|-------|-------------|-------|
| | Min. | Max. | Min. | Max. | | Min. | Max. | Min. | Max. |
| A | 0.102 | 0.110 | 2.600 | 2.800 | E | 0.140 | 0.152 | 3.550 | 3.850 |
| B | 0.059 | 0.067 | 1.500 | 1.700 | | | | | |
| C | 0.041 | 0.049 | 1.050 | 1.250 | | | | | |
| D | 0.018 | 0.026 | 0.450 | 0.650 | | | | | |

Notes: 1.Controlling dimension : millimeters.
 2.Lead thickness specified per L/F drawing with solder plating.
 3.If there is any question with packing specification or packing method, please contact your local CYStek sales office.

Material:

- Lead: Pure tin plated
- Mold Compound: Epoxy resin family, flammability solid burning class: UL94V-0

Important Notice:

- All rights are reserved. Reproduction in whole or in part is prohibited without the prior written approval of CYStek.
- CYStek reserves the right to make changes to its products without notice.
- CYStek **semiconductor products are not warranted to be suitable for use in Life-Support Applications, or systems.**
- CYStek assumes no liability for any consequence of customer product design, infringement of patents, or application assistance.