

Zener Diode Series

ZD52XXBN3

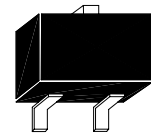

SOT-23

Thermal Characteristics

| Characteristics | Symbol | Max | Unit |
|---|----------|-------------|-------------|
| Total Device Dissipation FR-5 Board TA=25°C, Derate above 25°C | PD | 225 1.8 | mW mW/°C |
| Total Device Dissipation Alumina Substrate**TA=25°C, Derate above 25°C | PD | 300 2.4 | mW mW/°C |
| Thermal Resistance Junction to Ambient | RθJA | 417 | °C/W |
| Junction and Storage Temperature | Tj, Tstg | -55 to +150 | °C |

*FR-5 - 1.0×0.75×0.062 in. **Alumina - 0.4×0.3×0.024 in. 99.5% alumina.

Electrical Characteristic (VF=0.9V Max @IF=10mA for all types.)

| Device | Marking Code | Test Current IZT(mA) | Zener Voltage VZ(V) | Zzk IZ=0.25mA (Ω,Max) | Zzt IZ=IZT (Ω,Max) | Max. Reverse Current | |
|---------|--------------|-------------------------|------------------------|-----------------------------|--------------------------|----------------------|--------|
| | | | | | | IR(uA) | @VR(V) |
| ZD5221B | 18A | 20 | 2.4 ±5% | 1200 | 30 | 100 | 1.0 |
| ZD5222B | 18B | 20 | 2.5 ±5% | 1250 | 30 | 100 | 1.0 |
| ZD5223B | 18C | 20 | 2.7 ±5% | 1300 | 30 | 75 | 1.0 |
| ZD5225B | 18E | 20 | 3.0 ±5% | 1600 | 29 | 50 | 1.0 |
| ZD5226B | 8A | 20 | 3.3 ±5% | 1600 | 28 | 25 | 1.0 |
| ZD5227B | 8B | 20 | 3.6 ±5% | 1700 | 24 | 15 | 1.0 |
| ZD5228B | 8C | 20 | 3.9 ±5% | 1900 | 23 | 10 | 1.0 |
| ZD5229B | 8D | 20 | 4.3 ±5% | 2000 | 22 | 5.0 | 1.0 |
| ZD5230B | 8E | 20 | 4.7 ±5% | 1900 | 19 | 5.0 | 2.0 |
| ZD5231B | 8F | 20 | 5.1 ±5% | 1600 | 17 | 5.0 | 2.0 |
| ZD5232B | 8G | 20 | 5.6 ±5% | 1600 | 11 | 5.0 | 3.0 |
| ZD5233B | 8H | 20 | 6.0 ±5% | 1600 | 7.0 | 5.0 | 3.5 |
| ZD5234B | 8J | 20 | 6.2 ±5% | 1000 | 7.0 | 5.0 | 4.0 |
| ZD5235B | 8K | 20 | 6.8 ±5% | 750 | 5.0 | 3.0 | 5.0 |
| ZD5236B | 8L | 20 | 7.5 ±5% | 500 | 6.0 | 3.0 | 6.0 |
| ZD5237B | 8M | 20 | 8.2 ±5% | 500 | 8.0 | 3.0 | 6.5 |
| ZD5238B | 8N | 20 | 8.7 ±5% | 600 | 8.0 | 3.0 | 6.5 |
| ZD5239B | 8P | 20 | 9.1 ±5% | 600 | 10 | 3.0 | 7.0 |
| ZD5240B | KF5 | 20 | 10 ±5% | 600 | 17 | 3.0 | 8.0 |
| ZD5241B | 8R | 20 | 11 ±5% | 600 | 22 | 2.0 | 8.4 |
| ZD5242B | 8S | 20 | 12 ±5% | 600 | 30 | 1.0 | 9.1 |
| ZD5243B | 8T | 9.5 | 13 ±5% | 600 | 13 | 0.5 | 9.9 |
| ZD5244B | 8U | 9.0 | 14 ±5% | 600 | 15 | 0.1 | 10 |



Electrical Characteristic(Cont.)

| | | | | | | | |
|---------|-----|-----|--------|-----|----|-----|----|
| ZD5245B | 8V | 8.5 | 15 ±5% | 600 | 16 | 0.1 | 11 |
| ZD5246B | 8W | 7.8 | 16 ±5% | 600 | 17 | 0.1 | 12 |
| ZD5247B | 8X | 7.4 | 17 ±5% | 600 | 19 | 0.1 | 13 |
| ZD5248B | 8Y | 7.0 | 18 ±5% | 600 | 21 | 0.1 | 14 |
| ZD5249B | 8Z | 6.6 | 19 ±5% | 600 | 23 | 0.1 | 14 |
| ZD5250B | 81A | 6.2 | 20 ±5% | 600 | 25 | 0.1 | 15 |
| ZD5251B | 81B | 5.6 | 22 ±5% | 600 | 29 | 0.1 | 17 |
| ZD5252B | 81C | 5.2 | 24 ±5% | 600 | 33 | 0.1 | 18 |
| ZD5253B | 81D | 5.0 | 25 ±5% | 600 | 35 | 0.1 | 19 |
| ZD5254B | 81E | 4.6 | 27 ±5% | 600 | 41 | 0.1 | 21 |
| ZD5255B | 81F | 4.5 | 28 ±5% | 600 | 44 | 0.1 | 21 |
| ZD5256B | 81G | 4.2 | 30 ±5% | 600 | 49 | 0.1 | 23 |
| ZD5257B | 81H | 3.8 | 33 ±5% | 700 | 58 | 0.1 | 25 |
| ZD5258B | 81J | 3.4 | 36 ±5% | 700 | 70 | 0.1 | 27 |

Characteristic Curves

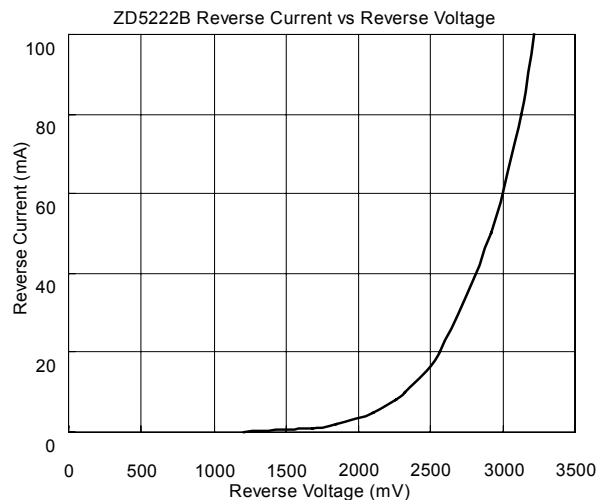
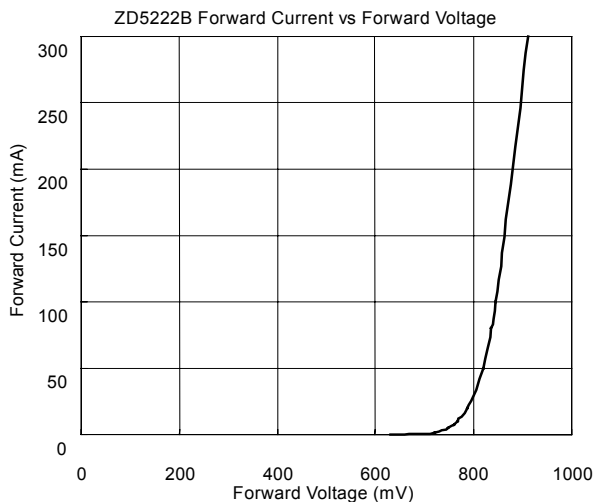
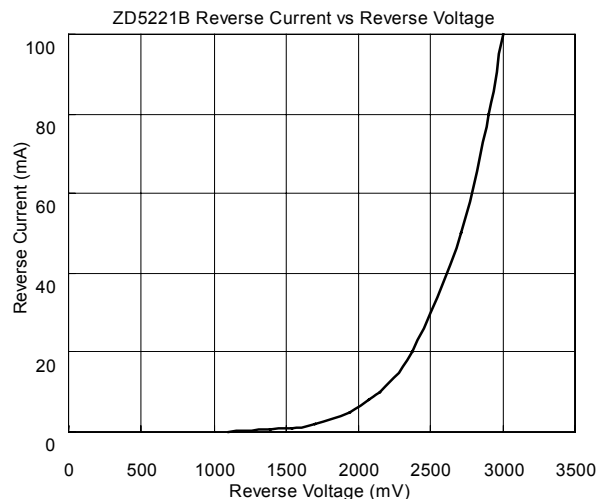
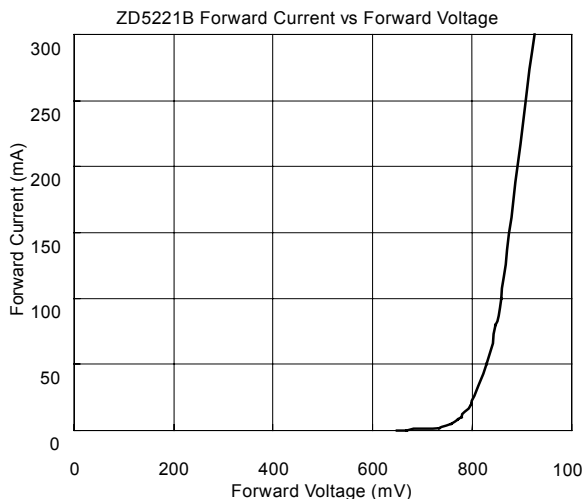

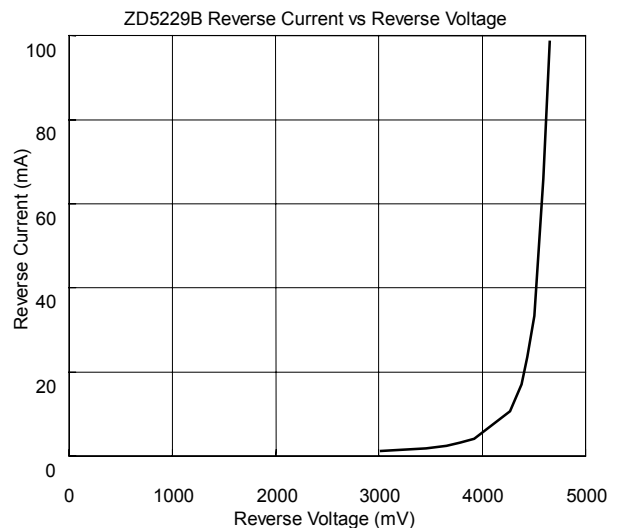
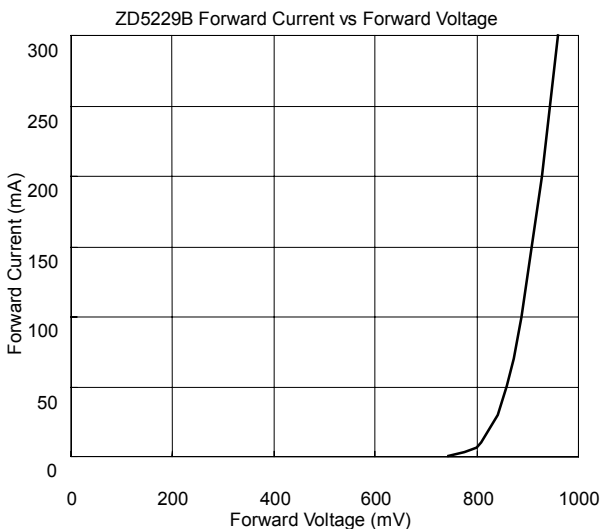
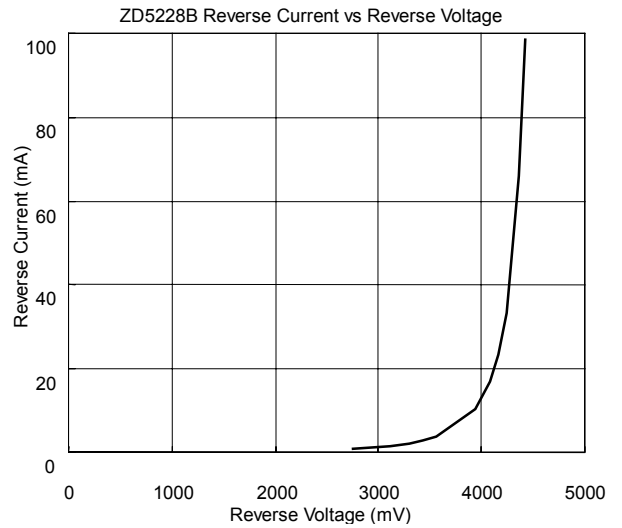
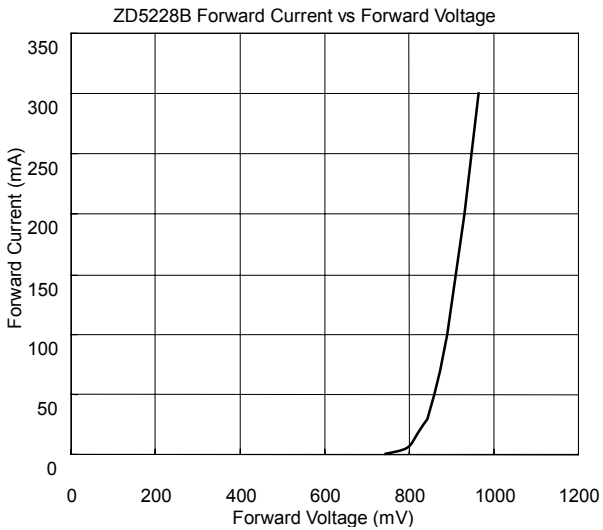
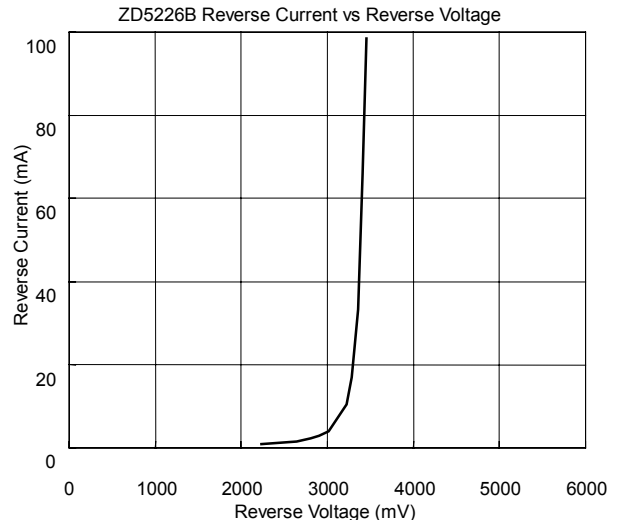
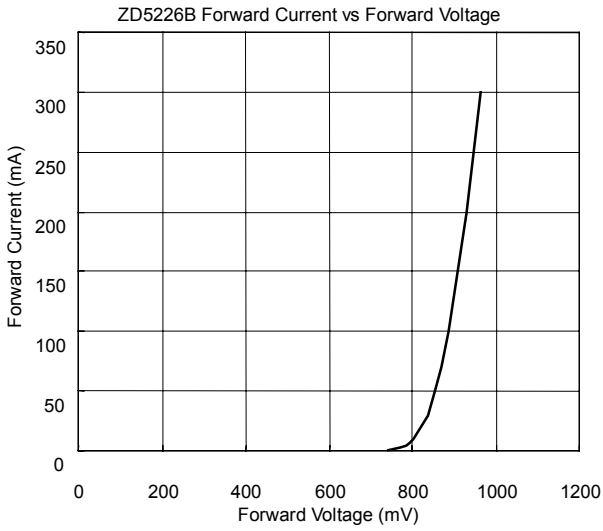

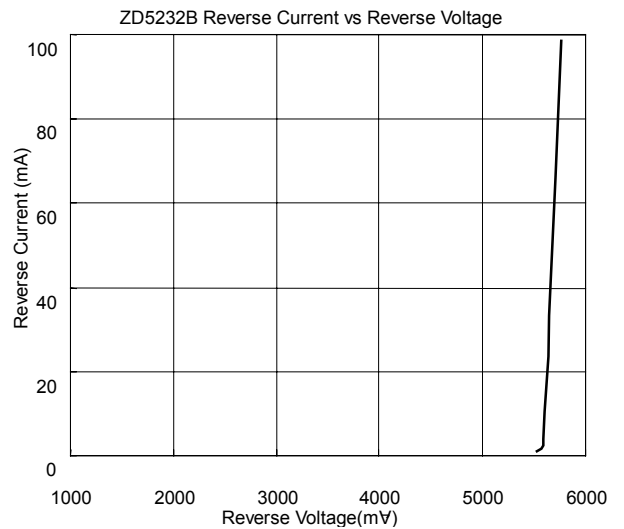
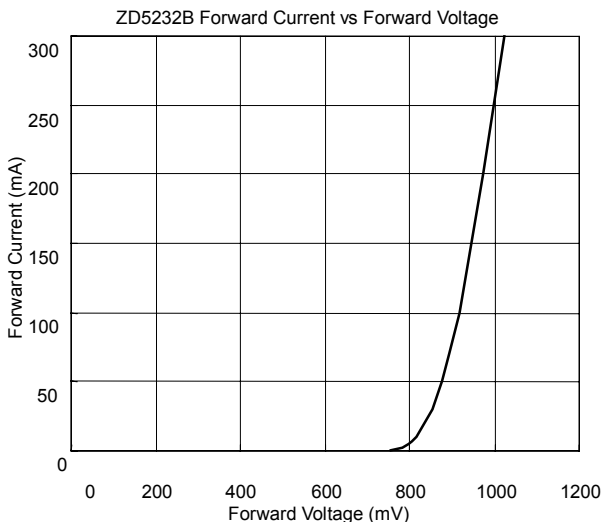
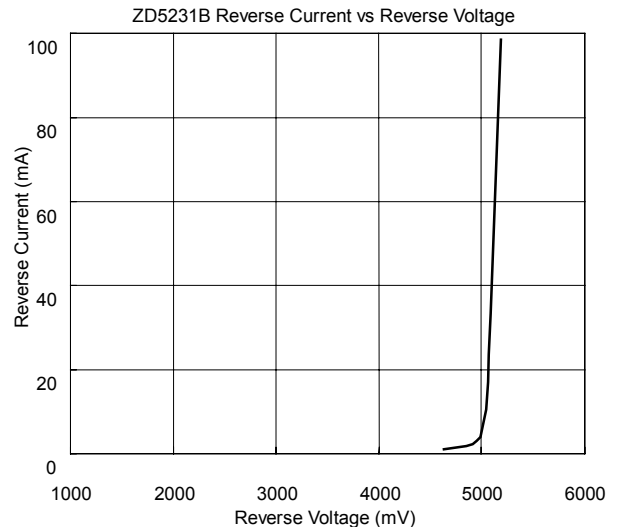
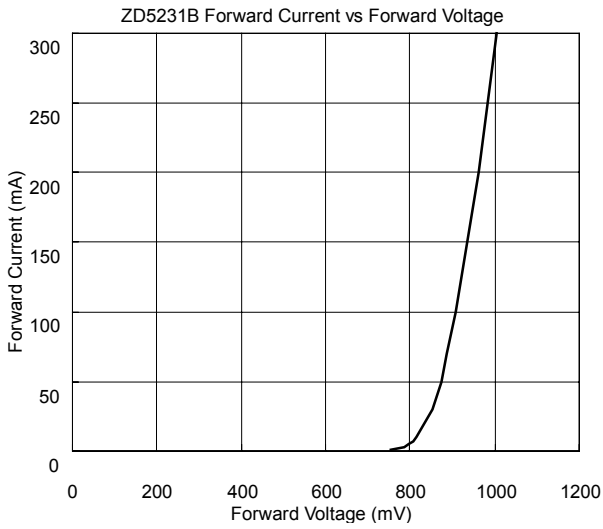
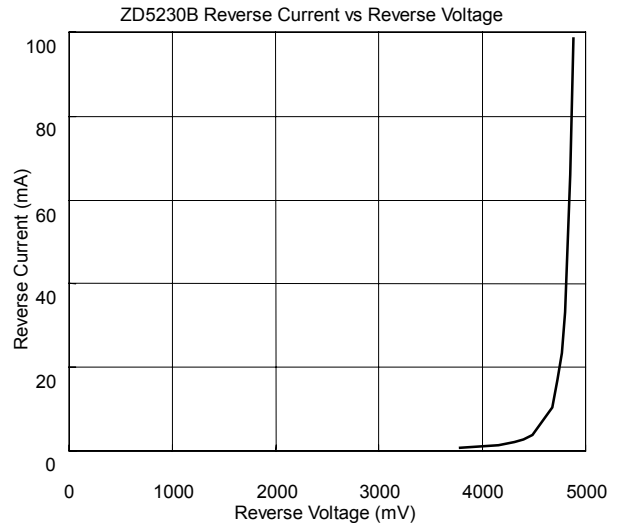
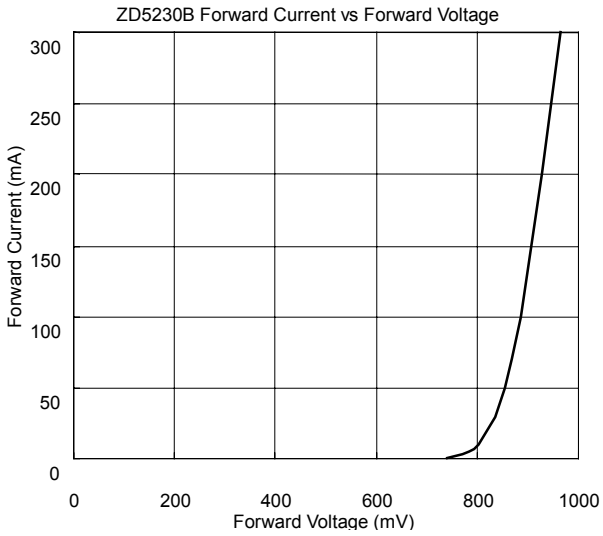

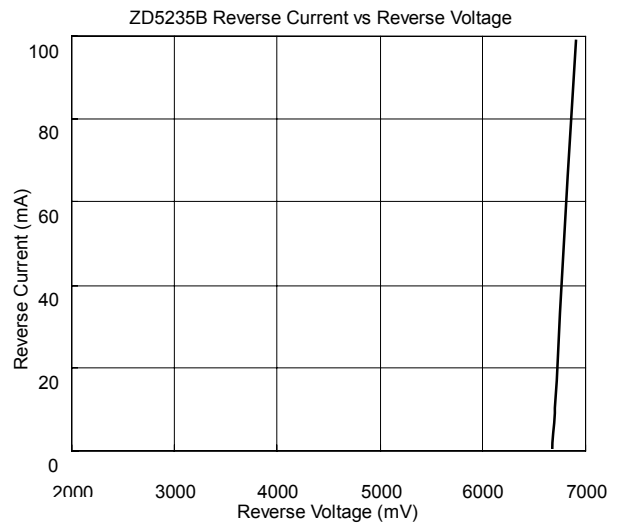
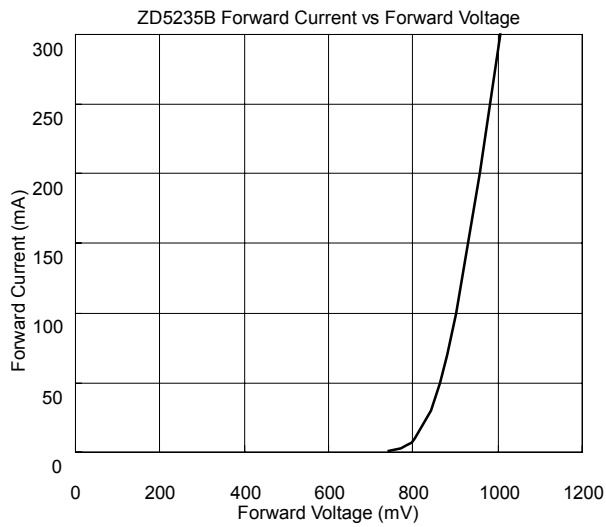
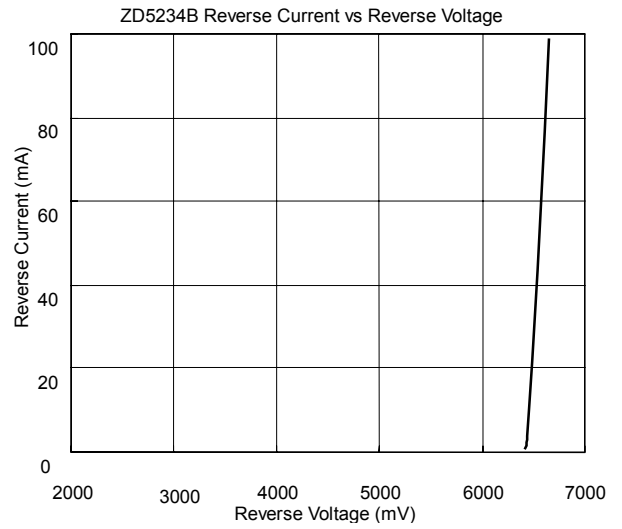
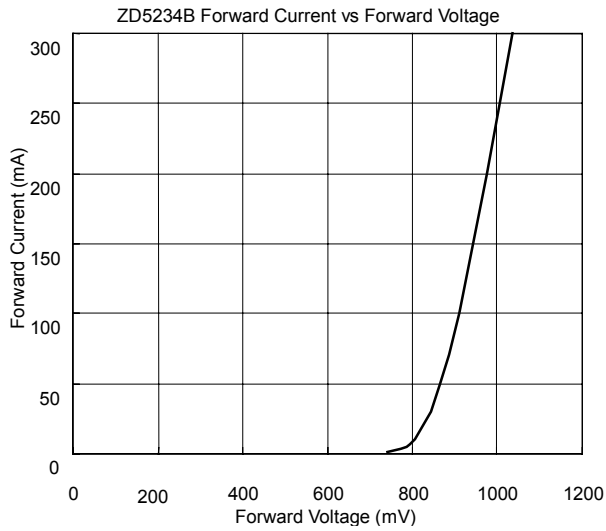
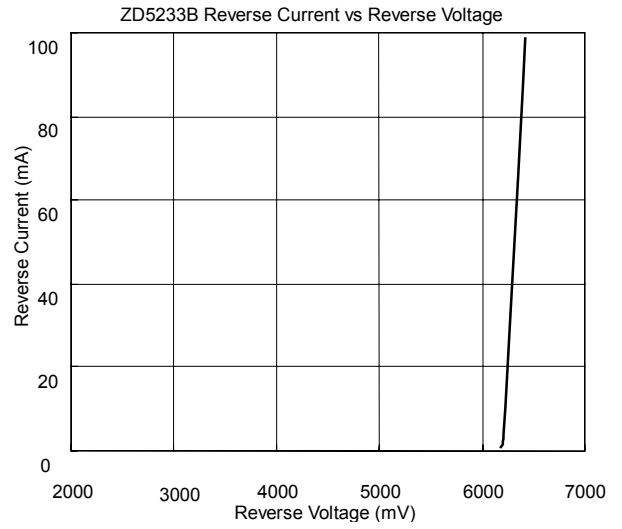
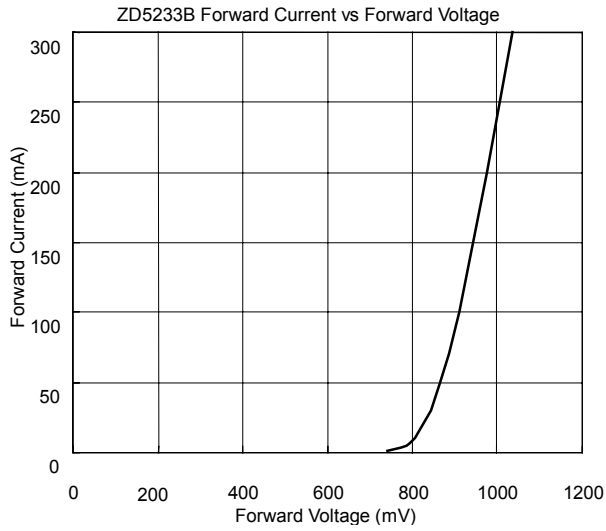

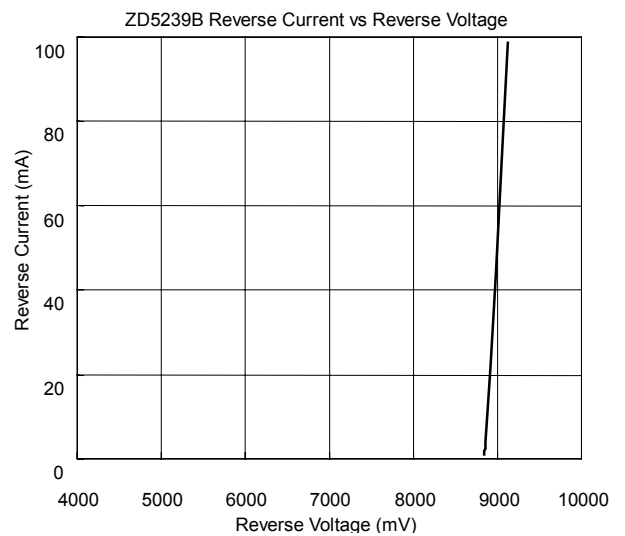
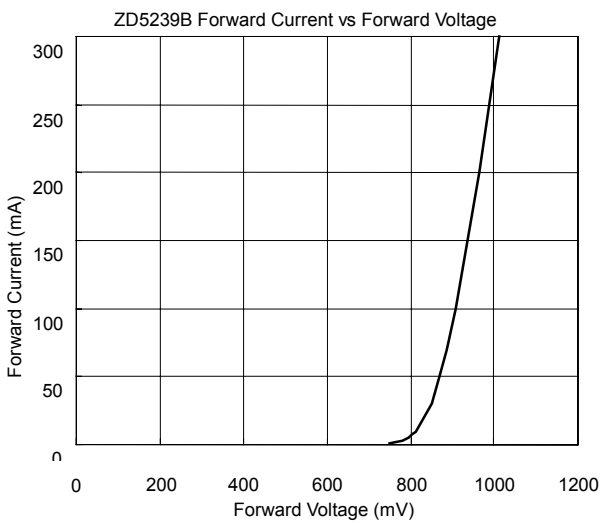
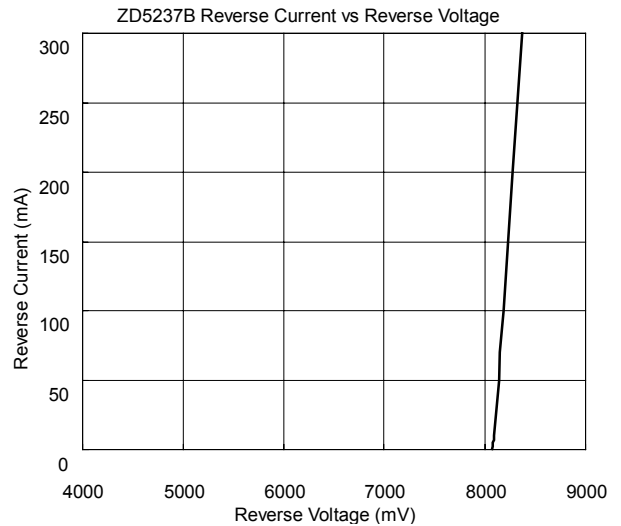
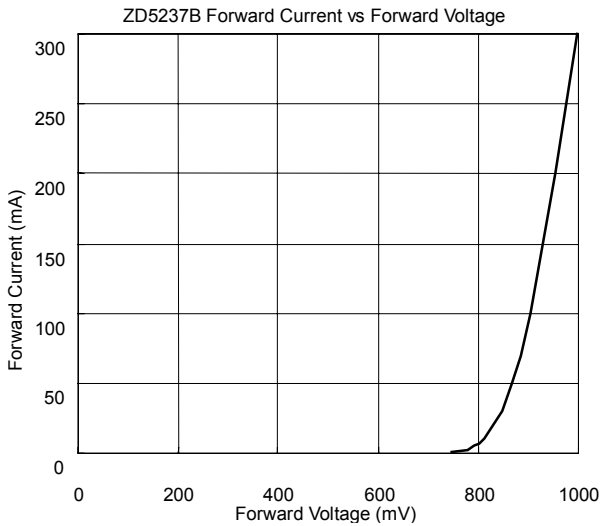
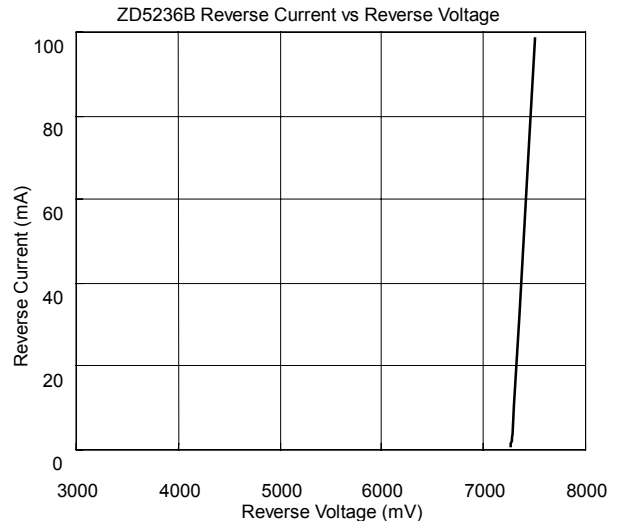
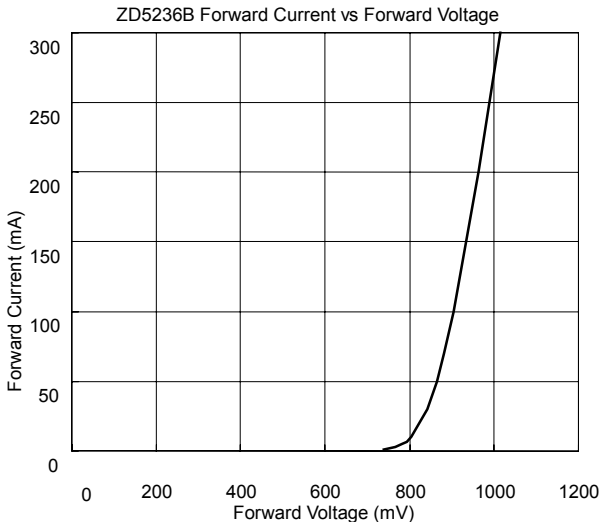

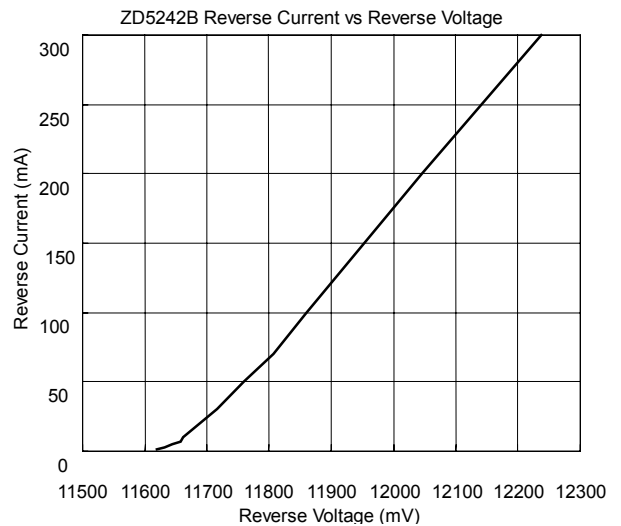
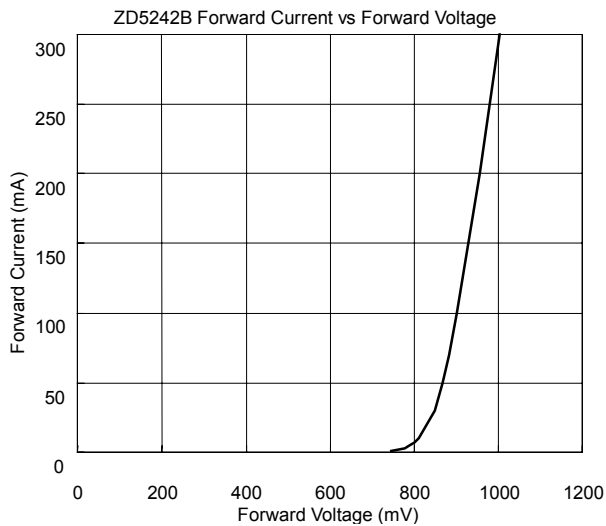
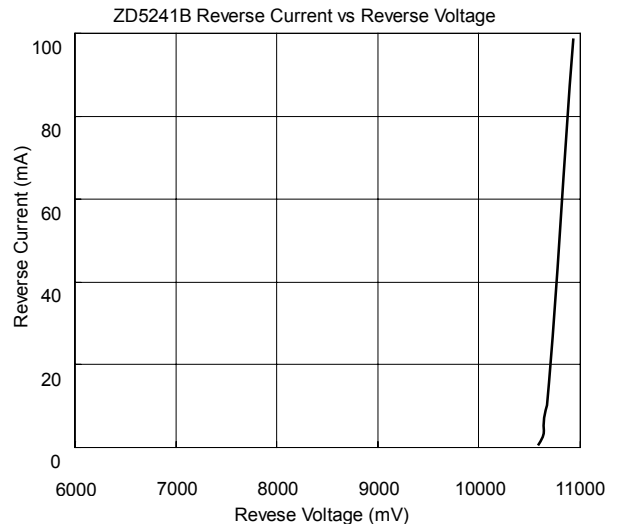
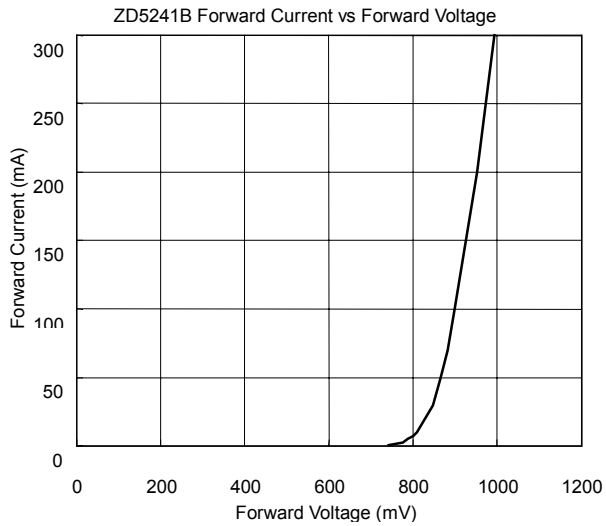
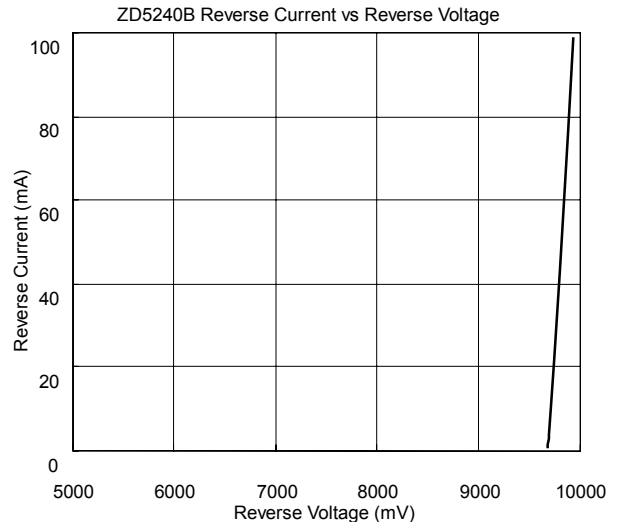
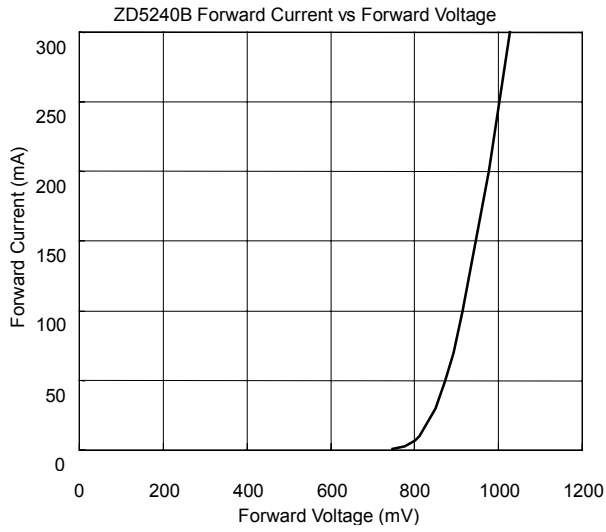

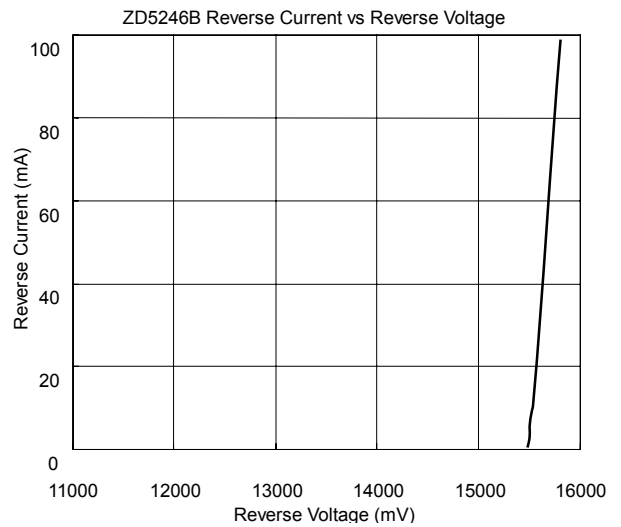
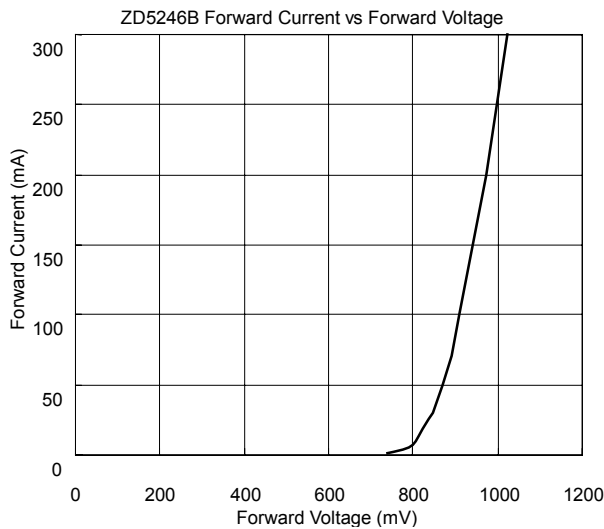
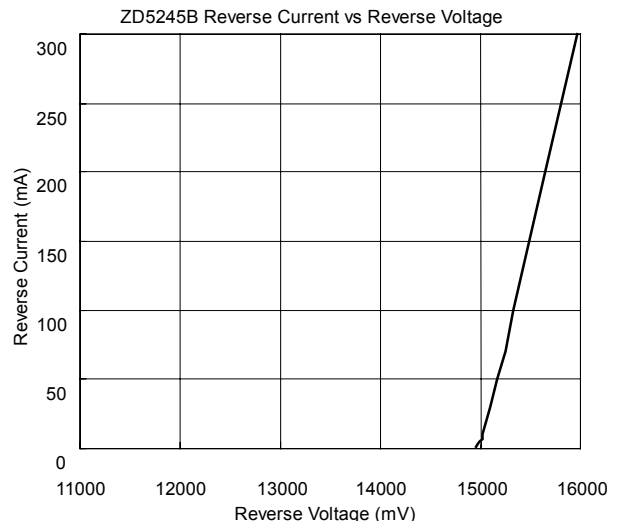
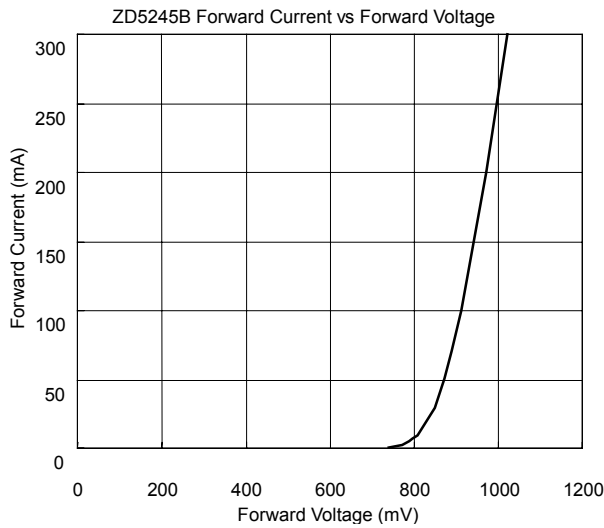
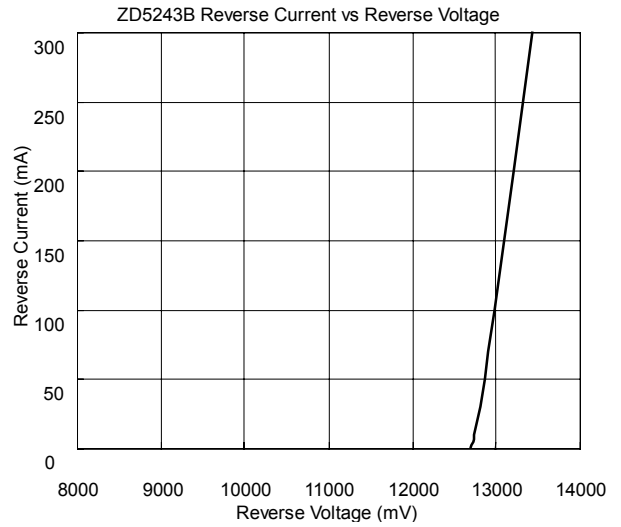
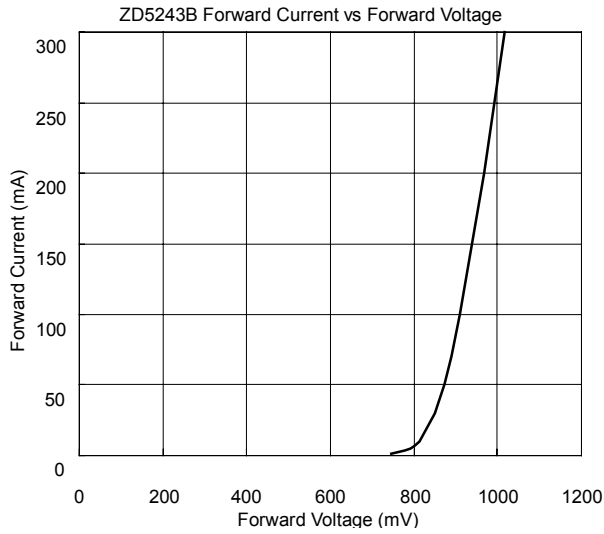

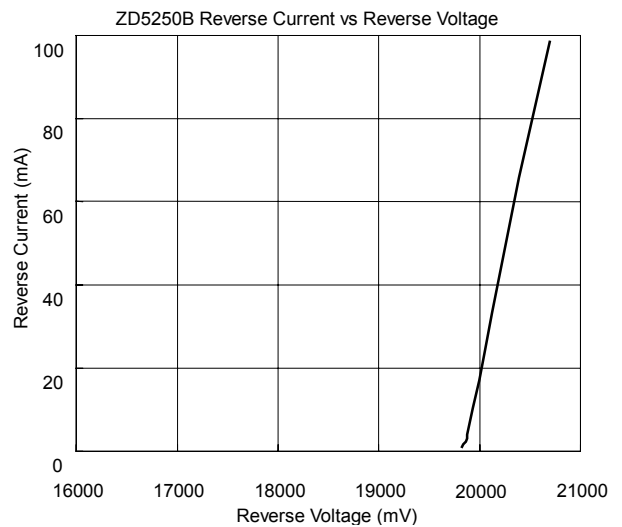
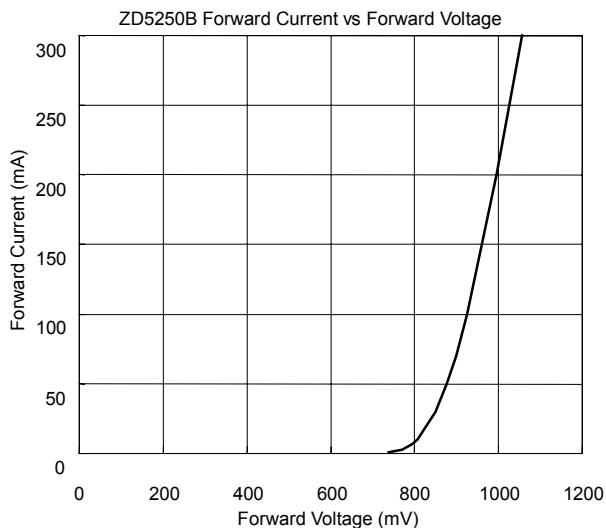
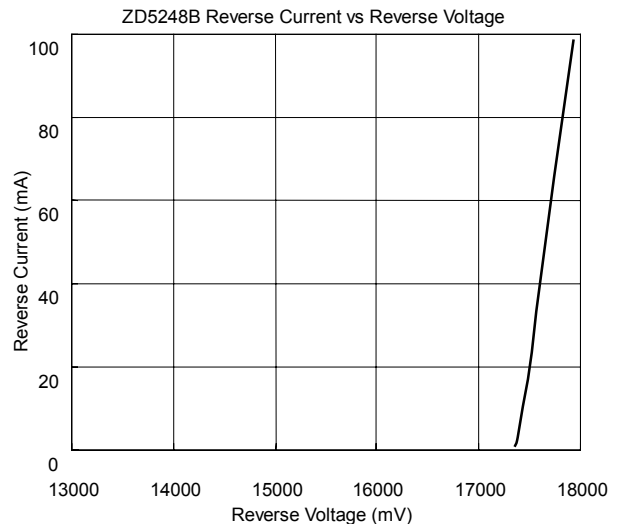
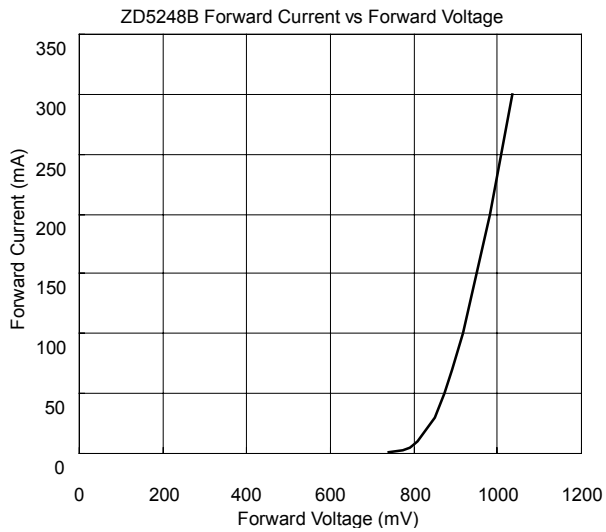
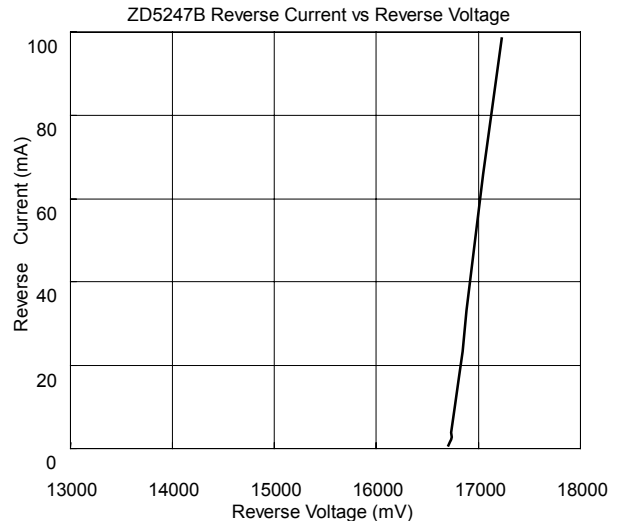
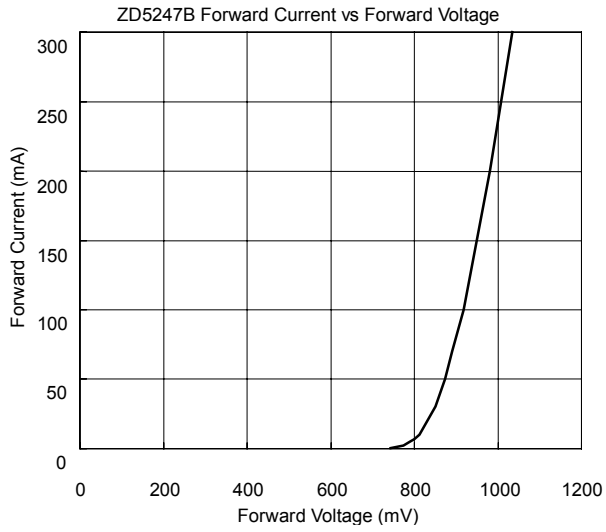

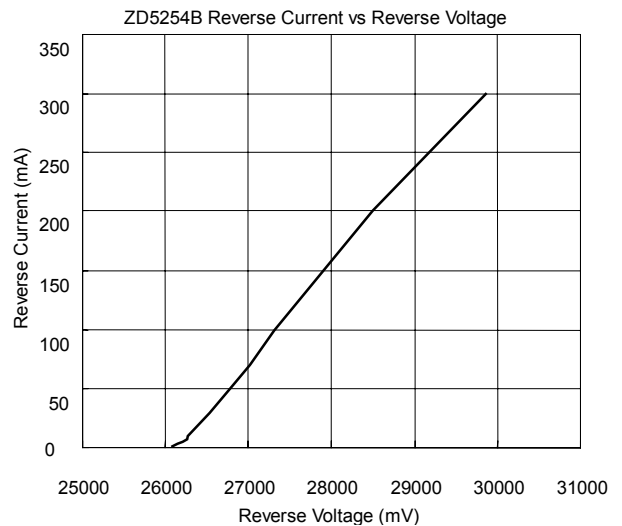
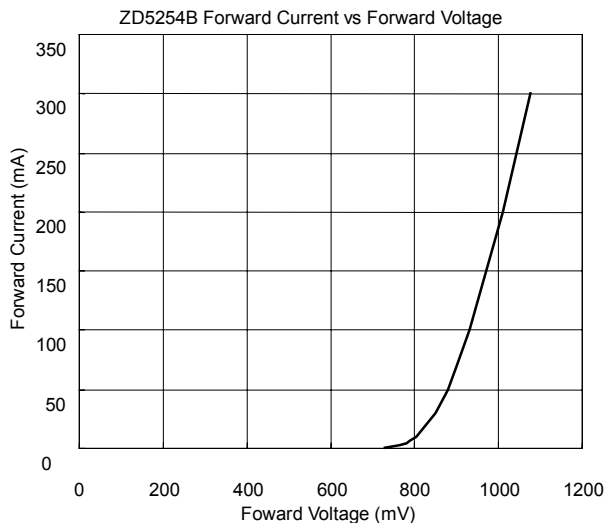
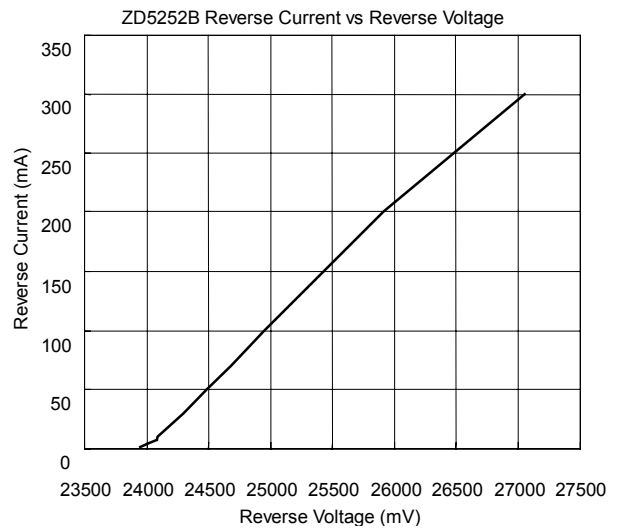
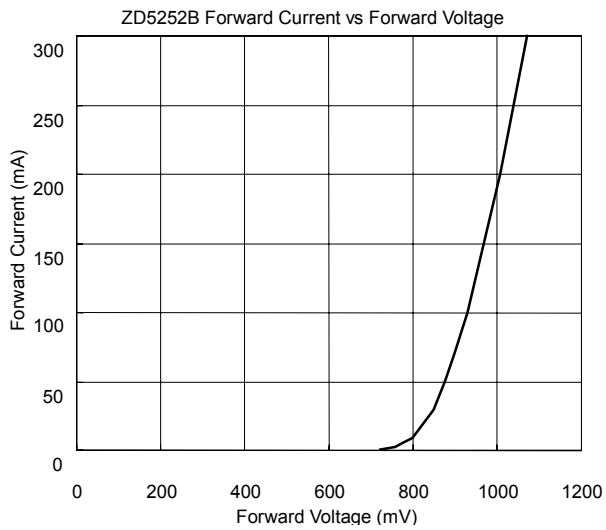
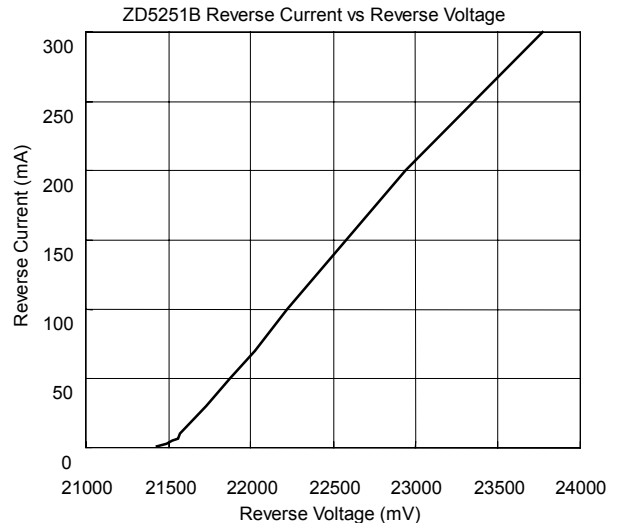
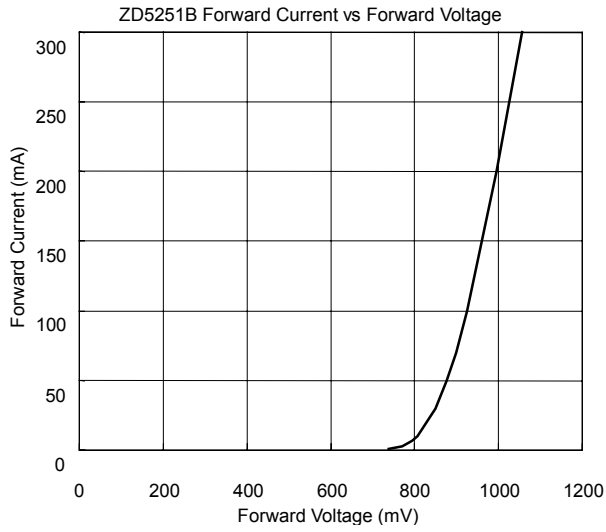

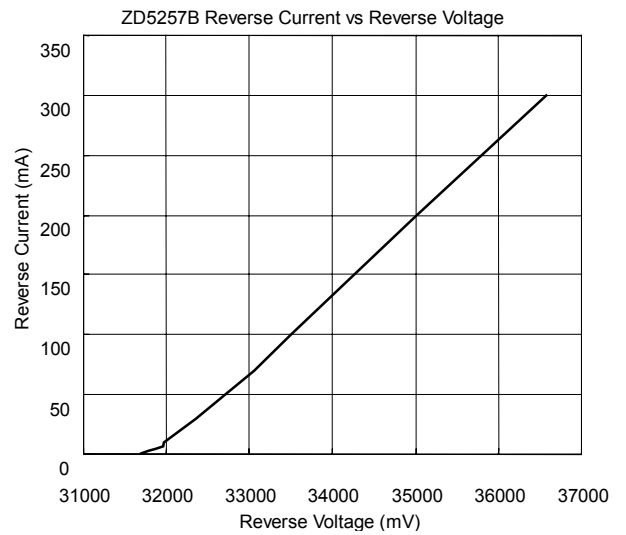
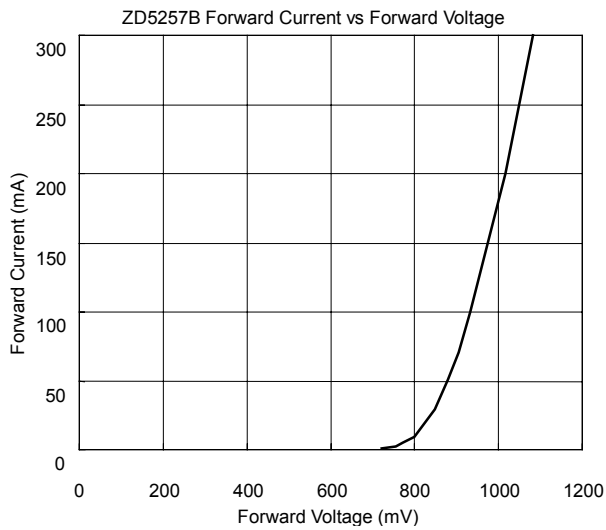
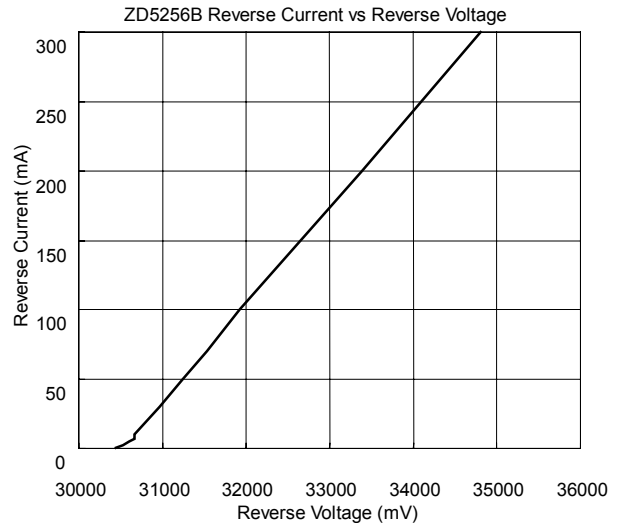
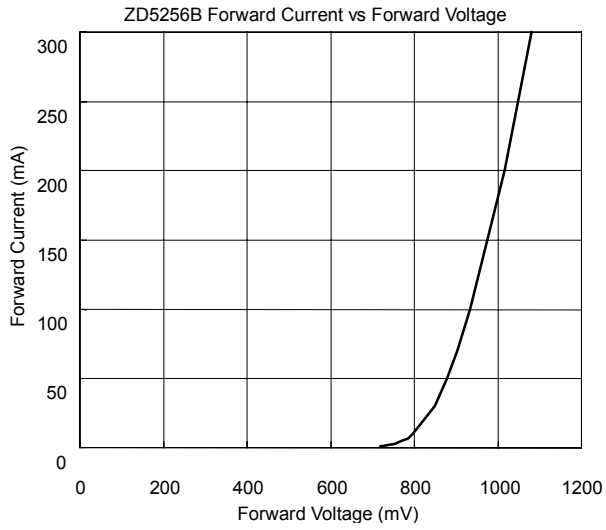

Recommended Footprint

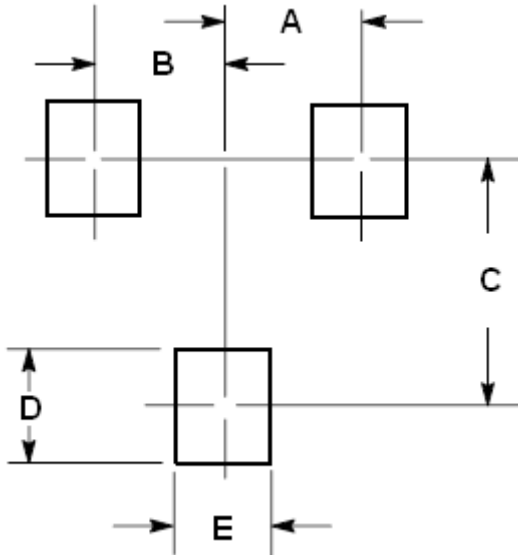

| DIM | Inches | Millimeters |
|-----|--------|-------------|
| | Typ | Typ |
| A | 0.039 | 1.0 |
| B | 0.039 | 1.0 |
| C | 0.079 | 2.0 |
| D | 0.035 | 0.9 |
| E | 0.031 | 0.8 |

Ordering Information

| Device | Package | Shipping |
|------------------|---|------------------------|
| ZD52XXBN3-0-T1-G | SOT-23 (Pb-free lead plating and halogen-free package) | 3000 pcs / Tape & Reel |

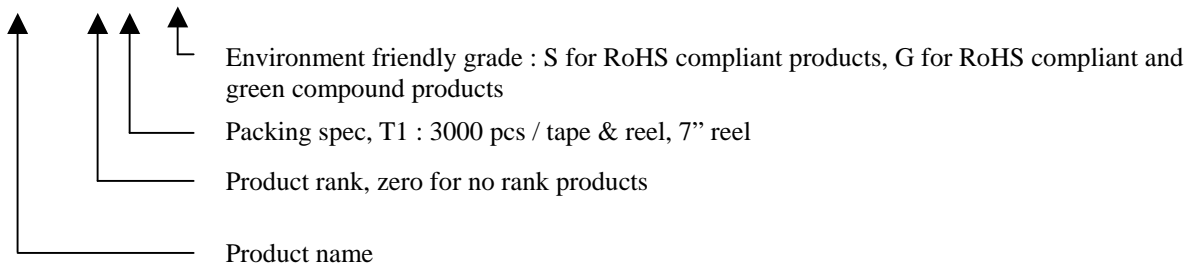

Reel Dimension

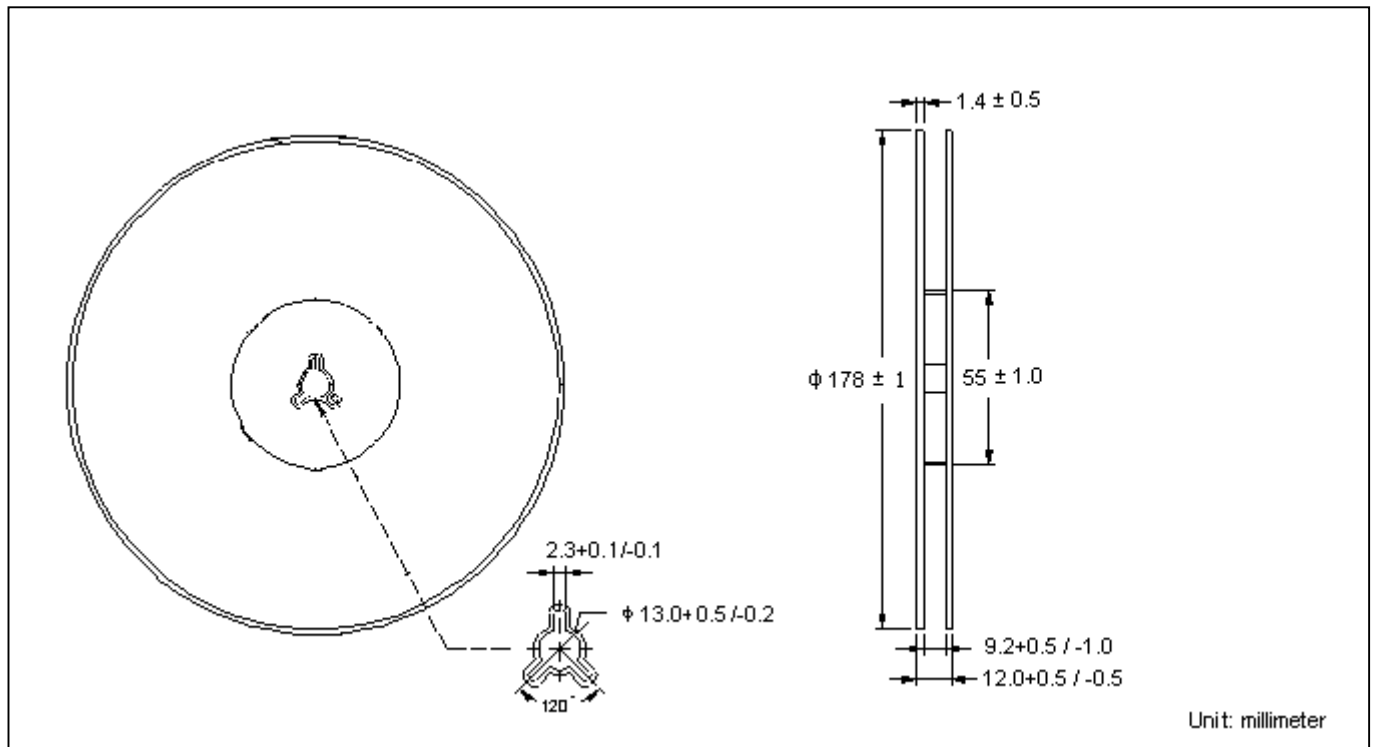

Carrier Tape Dimension

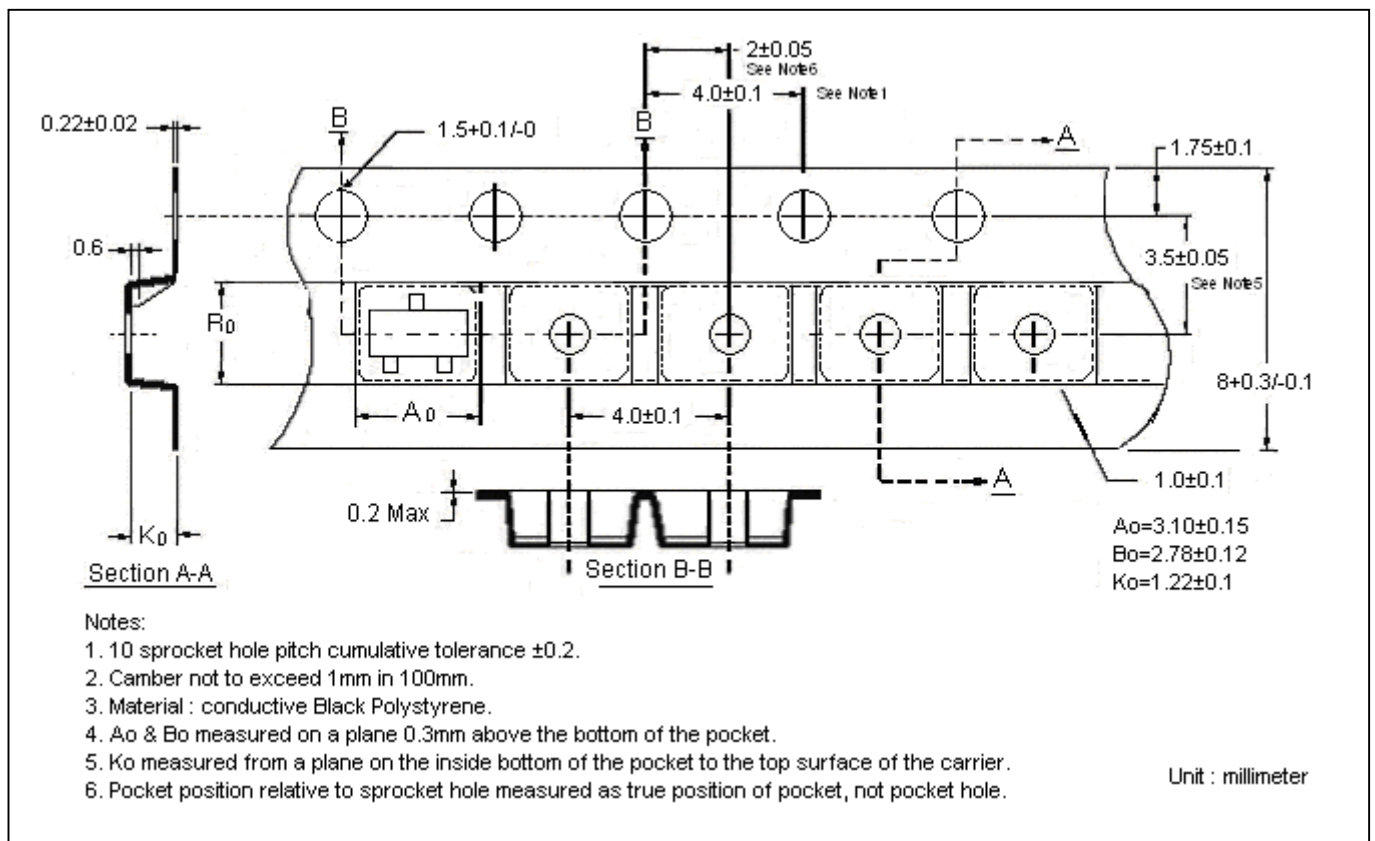

Recommended wave soldering condition

| | | |
|-----------------|------------------|-----------------|
| Product | Peak Temperature | Soldering Time |
| Pb-free devices | 260 +0/-5 °C | 5 +1/-1 seconds |

Recommended temperature profile for IR reflow

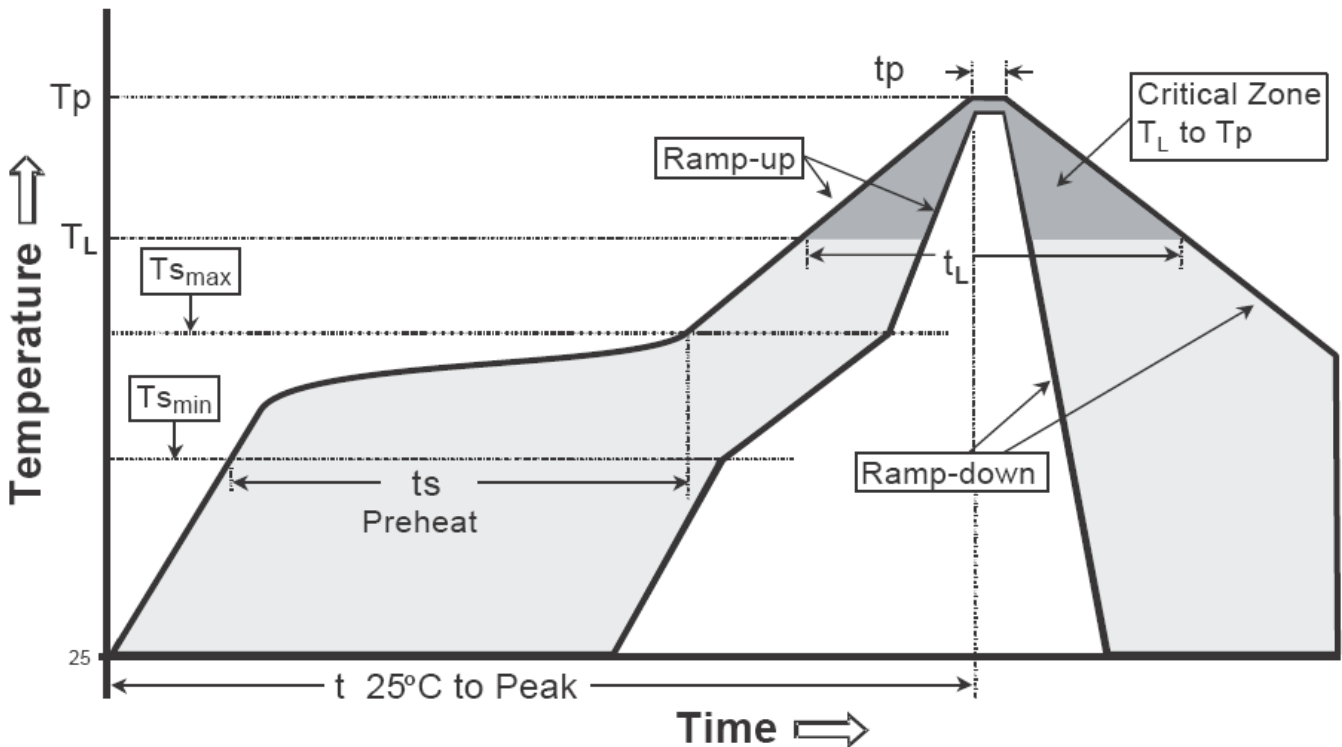

| Profile feature | Sn-Pb eutectic Assembly | Pb-free Assembly |
|--|-------------------------|------------------|
| Average ramp-up rate (Tsmmax to Tp) | 3°C/second max. | 3°C/second max. |
| Preheat | | |
| -Temperature Min(Ts min) | 100°C | 150°C |
| -Temperature Max(Ts max) | 150°C | 200°C |
| -Time(ts min to ts max) | 60-120 seconds | 60-180 seconds |
| Time maintained above: | | |
| -Temperature (Tl) | 183°C | 217°C |
| - Time (tl) | 60-150 seconds | 60-150 seconds |
| Peak Temperature(Tp) | 240 +0/-5 °C | 260 +0/-5 °C |
| Time within 5°C of actual peak temperature(tp) | 10-30 seconds | 20-40 seconds |
| Ramp down rate | 6°C/second max. | 6°C/second max. |
| Time 25 °C to peak temperature | 6 minutes max. | 8 minutes max. |

Note : All temperatures refer to topside of the package, measured on the package body surface.

SOT-23 Dimension

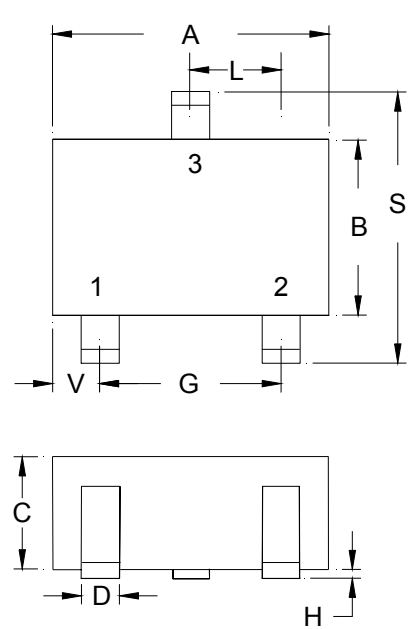
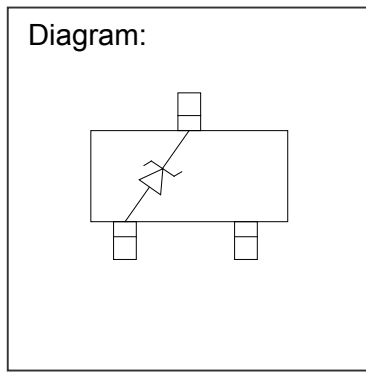
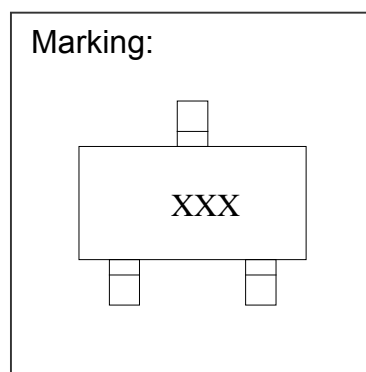

Diagram:



Marking:



3-Lead SOT-23 Plastic Surface Mounted Package
 CYStek Package Code: N3

Style: Pin 1.Anode 2.NC 3.Cathode

*: Typical

| DIM | Inches | | Millimeters | | DIM | Inches | | Millimeters | |
|-----|--------|--------|-------------|------|-----|--------|--------|-------------|-------|
| | Min. | Max. | Min. | Max. | | Min. | Max. | Min. | Max. |
| A | 0.1102 | 0.1204 | 2.80 | 3.04 | J | 0.0034 | 0.0070 | 0.085 | 0.177 |
| B | 0.0472 | 0.0630 | 1.20 | 1.60 | K | 0.0128 | 0.0266 | 0.32 | 0.67 |
| C | 0.0335 | 0.0512 | 0.89 | 1.30 | L | 0.0335 | 0.0453 | 0.85 | 1.15 |
| D | 0.0118 | 0.0197 | 0.30 | 0.50 | S | 0.0830 | 0.1083 | 2.10 | 2.75 |
| G | 0.0669 | 0.0910 | 1.70 | 2.30 | V | 0.0098 | 0.0256 | 0.25 | 0.65 |
| H | 0.0005 | 0.0040 | 0.013 | 0.10 | | | | | |

Notes: 1.Controlling dimension: millimeters.
 2.Maximum lead thickness includes lead finish thickness, and minimum lead thickness is the minimum thickness of base material.
 3.If there is any question with packing specification or packing method, please contact your local CYStek sales office.

Material:

- Lead: Pure tin plated.
- Mold Compound: Epoxy resin family, flammability solid burning class: UL94V-0.

Important Notice:

- All rights are reserved. Reproduction in whole or in part is prohibited without the prior written approval of CYStek.
- CYStek reserves the right to make changes to its products without notice.
- CYStek **semiconductor products are not warranted to be suitable for use in Life-Support Applications, or systems.**
- CYStek assumes no liability for any consequence of customer product design, infringement of patents, or application assistance.