

500mW Zener Diode Series

ZD52XXBSH

Description

The ZD52XXBSH series covers zener voltage range from 2.4V to 75V, and is encapsulated in SOD-123 package, very suitable for low cost, low power voltage regulation application.

Features

- Ultra small surface mount package
- General purpose, medium current
- Planar die construction
- Pb-free lead plating and halogen-free package

Symbol

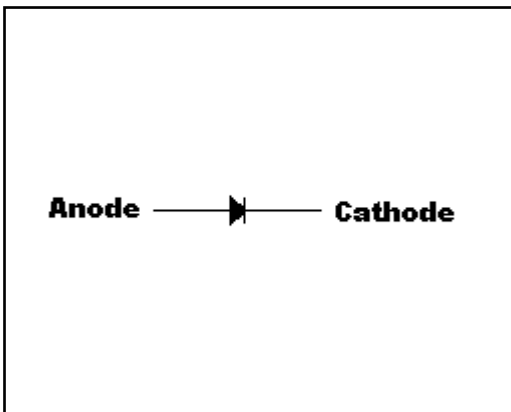

Outline

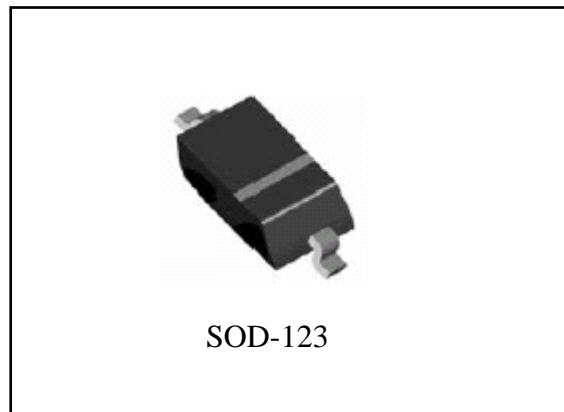

Ordering Information

Device	Package	Shipping
ZD52XXBSH-0-T1-G	SOD-123 (Pb-free lead plating and halogen-free package)	3000 pcs / tape & reel

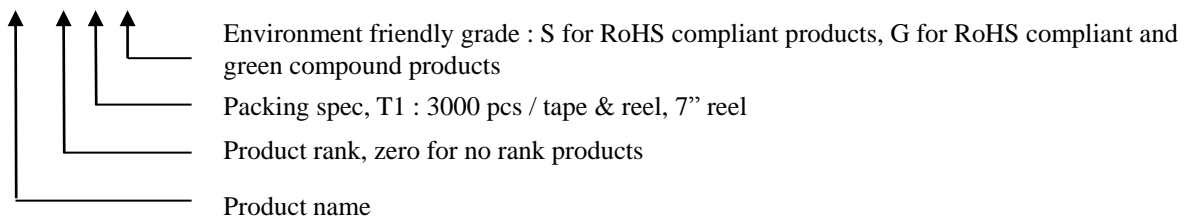



Absolute Maximum Ratings(Tj=25°C, unless otherwise specified)

- Maximum Temperatures
 Operating and Storage Temperature Range Tj, Tstg -65~+150 °C
- Maximum Forward Voltage @ If=10mA0.9V
- Maximum Power Dissipation
 Total Power Dissipation @TL=75 °C Ptot (Note 1)500 mW
- Thermal Resistance, Junction to Ambient Air RθJL (Note 1).....150°C/W
- Maximum Z-current..... Ptot/Vz mA
- ESD susceptibility (Note 2)..... 30KV

Note : 1. Parts mounted on FR-5 board with area of 3.5inch × 1.5inch.
 2. Human body model.

Electrical Characteristic (Ta=25°C, unless otherwise noted)

Device	Type Code	Nom. Zener Voltage				Max. Zener Impedance				Max. Zener Current	Max. Reverse Leakage Current	
		Vz@IzT				ZzT@ IzT		Zzk@ IzK			IzM@Ta	Ir
		Nom. (V)	Min. (V)	Max. (V)	IzT (mA)	ZzT (Ω)	IzT (mA)	Zzk (Ω)	IzK (mA)			
ZD5221B	C1	2.4	2.28	2.52	20	30	20	1200	0.25	188	100	1.0
ZD5223B	C3	2.7	2.57	2.84	20	30	20	1300	0.25	167	75	1.0
ZD5225B	C5	3.0	2.85	3.15	20	30	20	1600	0.25	150	50	1.0
ZD5226B	G1	3.3	3.14	3.47	20	28	20	1600	0.25	138	25	1.0
ZD5227B	G2	3.6	3.42	3.78	20	24	20	1700	0.25	126	15	1.0
ZD5228B	G3	3.9	3.71	4.10	20	23	20	1900	0.25	115	10	1.0
ZD5229B	G4	4.3	4.09	4.52	20	22	20	2000	0.25	106	5.0	1.0
ZD5230B	G5	4.7	4.47	4.94	20	19	20	1900	0.25	97	5.0	2.0
ZD5231B	E1	5.1	4.85	5.36	20	17	20	1600	0.25	89	5.0	2.0
ZD5232B	E2	5.6	5.32	5.88	20	11	20	1600	0.25	81	5.0	3.0
ZD5233B	E3	6.0	5.70	6.30	20	7.0	20	1600	0.25	76	5.0	3.5
ZD5234B	E4	6.2	5.89	6.51	20	7.0	20	1000	0.25	73	5.0	4.0
ZD5235B	E5	6.8	6.46	7.14	20	5.0	20	750	0.25	67	3.0	5.0
ZD5236B	F1	7.5	7.13	7.88	20	6.0	20	500	0.25	61	3.0	6.0
ZD5237B	F2	8.2	7.79	8.61	20	8.0	20	500	0.25	55	3.0	6.5
ZD5238B	F3	8.7	8.27	9.14	20	8.0	20	600	0.25	55	3.0	6.5
ZD5239B	F4	9.1	8.65	9.56	20	10	20	600	0.25	50	3.0	7.0
ZD5240B	F5	10	9.5	10.5	20	17	20	600	0.25	45	3.0	8.0
ZD5241B	H1	11	10.45	11.55	20	22	20	600	0.25	41	2.0	8.4
ZD5242B	H2	12	11.4	12.6	20	30	20	600	0.25	38	1.0	9.1
ZD5243B	H3	13	12.35	13.65	9.5	13	9.5	600	0.25	35	0.5	9.9
ZD5244B	H4	14	13.3	14.7	9	15	9	600	0.25	32	0.1	10
ZD5245B	H5	15	14.25	15.75	8.5	16	8.5	600	0.25	30	0.1	11
ZD5246B	J1	16	15.2	16.8	7.8	17	7.8	600	0.25	28	0.1	12
ZD5248B	J3	18	17.1	18.9	7.0	21	7.0	600	0.25	25	0.1	14
ZD5250B	J5	20	19	21	6.2	25	6.2	600	0.25	23	0.1	15

ZD5251B	K1	22	20.9	23.1	5.6	29	5.6	600	0.25	21	0.1	17
ZD5252B	K2	24	22.8	25.2	5.2	33	5.2	600	0.25	19.1	0.1	18
ZD5254B	K4	27	25.65	28.35	5.0	41	5.0	600	0.25	16.8	0.1	21
ZD5255B	K5	28	26.6	29.4	4.5	44	4.5	600	0.25	16.2	0.1	21
ZD5256B	M1	30	28.5	31.5	4.2	49	4.2	600	0.25	15.1	0.1	23
ZD5257B	M2	33	31.35	34.65	3.8	58	3.8	700	0.25	13.8	0.1	25
ZD5258B	M3	36	34.2	37.8	3.4	70	3.4	700	0.25	12.6	0.1	27
ZD5259B	M4	39	37.05	40.95	3.2	80	3.2	800	0.25	11.6	0.1	30
ZD5260B	M5	43	40.85	45.15	3	93	3	900	0.25	10.6	0.1	33
ZD5261B	N1	47	44.65	49.35	2.7	105	2.7	1000	0.25	9.6	0.1	36
ZD5262B	N2	51	48.45	53.55	2.5	125	2.5	1100	0.25	8.8	0.1	39
ZD5263B	N3	56	53.20	58.80	2.2	150	2.2	1300	0.25	8.0	0.1	43
ZD5264B	N4	60	57.00	63.00	2.1	170	2.1	1400	0.25	7.5	0.1	46
ZD5265B	N5	62	58.90	65.10	2.0	185	2.0	1400	0.25	7.3	0.1	47
ZD5266B	P1	68	64.60	71.40	1.8	230	1.8	1600	0.25	6.6	0.1	52
ZD5267B	P2	75	71.25	78.75	1.7	270	1.7	1700	0.25	6.0	0.1	56

Recommended Soldering Footprint



Typical Characteristics

Typical Temperature Coefficient

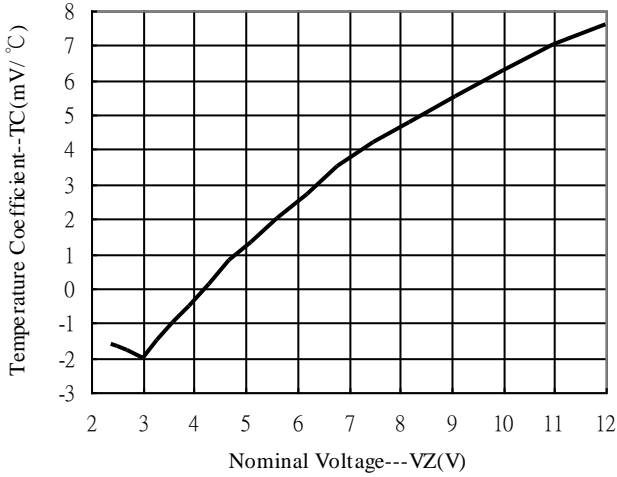

Dynamic Impedance

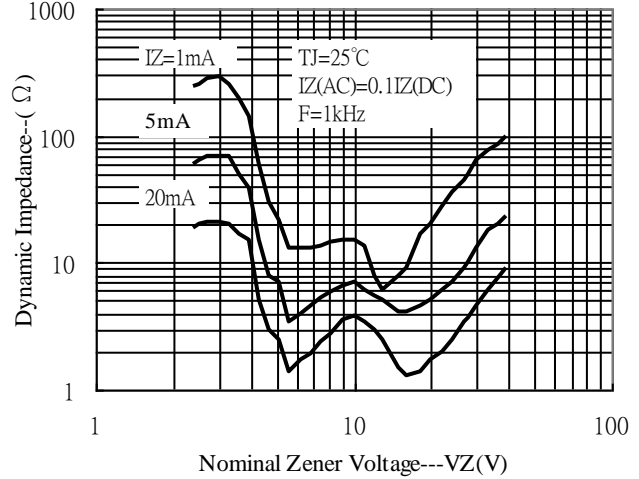

Typical Capacitance



Power Derating Curve

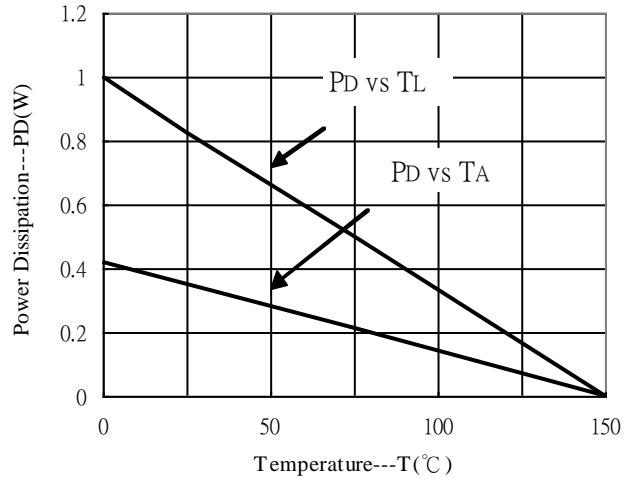

Zener Current vs Zener Voltage

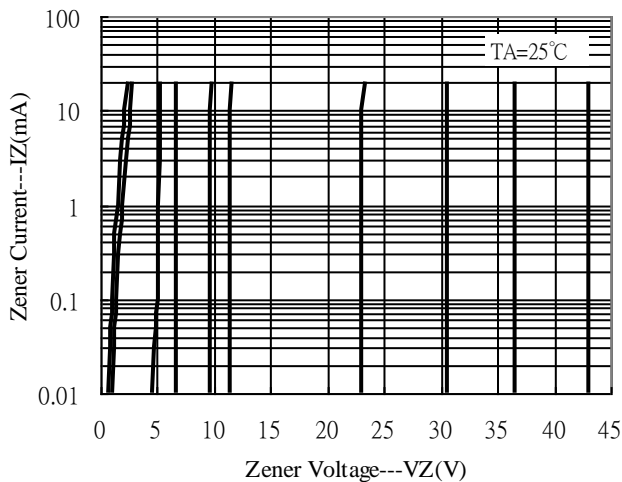

Typical Leakage Current



Reel Dimension

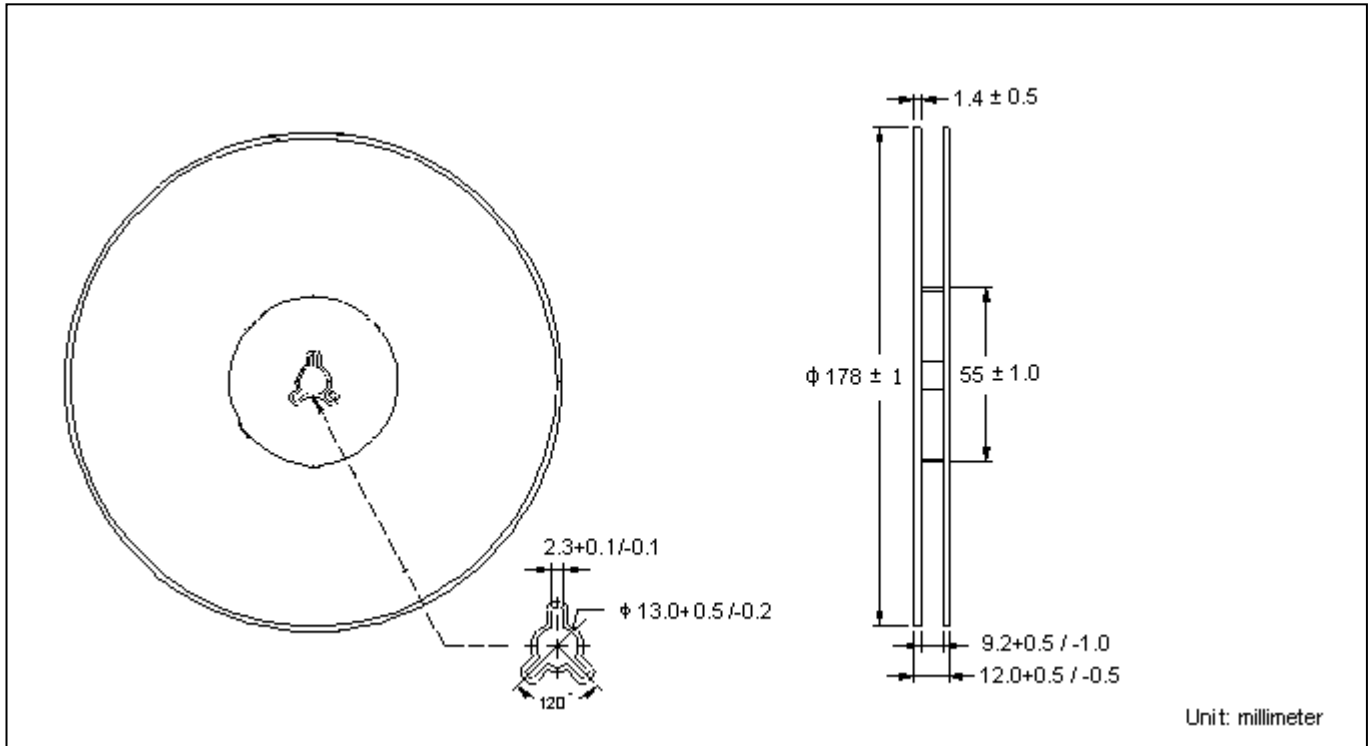

Carrier Tape Dimension

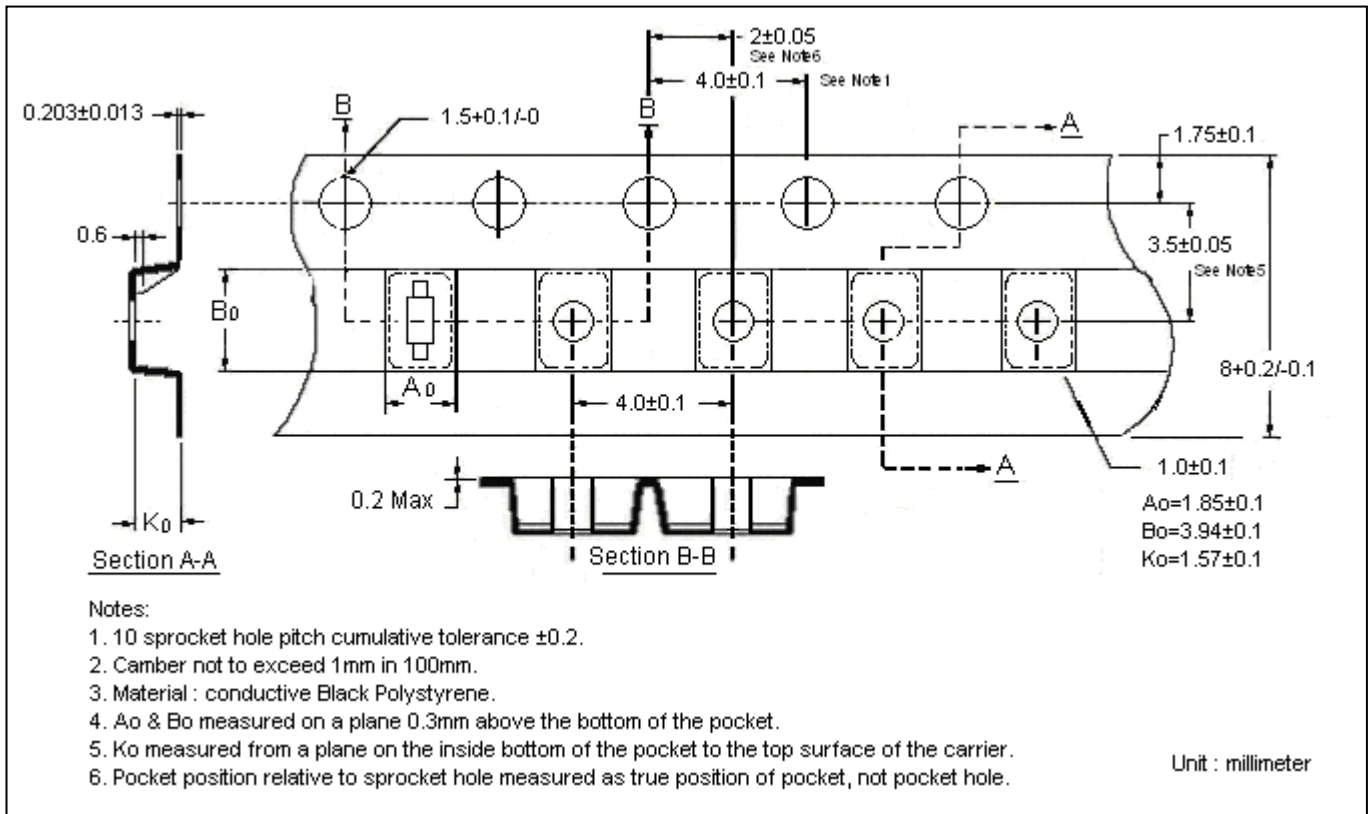

Recommended wave soldering condition

Product	Peak Temperature	Soldering Time
Pb-free devices	260 +0/-5 °C	5 +1/-1 seconds

Recommended temperature profile for IR reflow



Profile feature	Sn-Pb eutectic Assembly	Pb-free Assembly
Average ramp-up rate (T _{smax} to T _p)	3°C/second max.	3°C/second max.
Preheat		
-Temperature Min(T _{s min})	100°C	150°C
-Temperature Max(T _{s max})	150°C	200°C
-Time(t _{s min} to t _{s max})	60-120 seconds	60-180 seconds
Time maintained above:		
-Temperature (T _L)	183°C	217°C
- Time (t _L)	60-150 seconds	60-150 seconds
Peak Temperature(T _p)	240 +0/-5 °C	260 +0/-5 °C
Time within 5°C of actual peak temperature(tp)	10-30 seconds	20-40 seconds
Ramp down rate	6°C/second max.	6°C/second max.
Time 25 °C to peak temperature	6 minutes max.	8 minutes max.

Note : All temperatures refer to topside of the package, measured on the package body surface.

SOD-123 Dimension

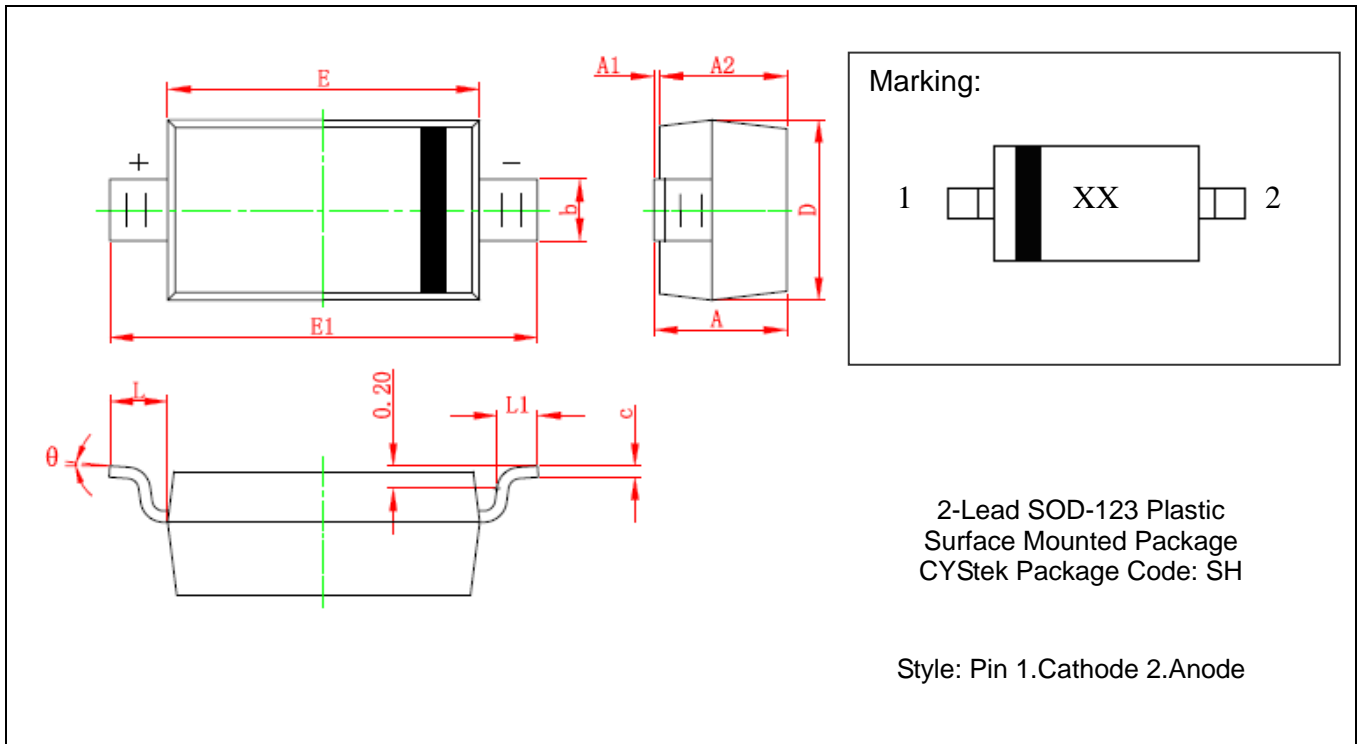

DIM	Millimeters		Inches		DIM	Millimeters		Inches	
	Min.	Max.	Min.	Max.		Min.	Max.	Min.	Max.
A	1.050	1.250	0.041	0.049	E	2.600	2.800	0.102	0.110
A1	0.000	0.100	0.000	0.004	E1	3.550	3.850	0.140	0.152
A2	1.050	1.115	0.041	0.045	L	0.500 REF		0.020 REF	
b	0.450	0.650	0.018	0.026	L1	0.250	0.450	0.010	0.018
c	0.080	0.150	0.003	0.006	θ	0°	8°	0°	8°
D	1.500	1.700	0.059	0.067					

Notes: 1.Controlling dimension : millimeters.
 2.Lead thickness specified per L/F drawing with solder plating.
 3.If there is any question with packing specification or packing method, please contact your local CYStek sales office.

Material:

- Lead: Pure tin plated.
- Mold Compound: Epoxy resin family, flammability solid burning class: UL94V-0.

Important Notice:

- All rights are reserved. Reproduction in whole or in part is prohibited without the prior written approval of CYStek.
- CYStek reserves the right to make changes to its products without notice.
- CYStek **semiconductor products are not warranted to be suitable for use in Life-Support Applications, or systems.**
- CYStek assumes no liability for any consequence of customer product design, infringement of patents, or application assistance.