

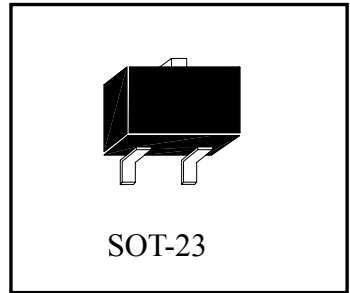

Zener Diode Series

# ZD52XXAN3



## Thermal Characteristics

Characteristics	Symbol	Max	Unit
Total Device Dissipation FR-5 Board TA=25°C, Derate above 25°C	P <sub>D</sub>	225	mW
		1.8	mW/°C
Total Device Dissipation Alumina Substrate**TA=25°C, Derate above 25°C	P <sub>D</sub>	300	mW
		2.4	mW/°C
Thermal Resistance Junction to Ambient	R <sub>θJA</sub>	417	°C/W
Junction and Storage Temperature	T <sub>j</sub> , T <sub>stg</sub>	-55 to +150	°C

\*FR-5 - 1.0×0.75×0.062 in. \*\*Alumina - 0.4×0.3×0.024 in. 99.5% alumina.

## Electrical Characteristic (V<sub>F</sub>=0.9V Max @I<sub>F</sub>=10mA for all types.)

Device	Marking Code	Nom. Zener Voltage			Max. Zener Impedance				Max. Zener Current	Max. Reverse Leakage Current	
		V <sub>Z</sub> @I <sub>ZT</sub> (V)			Z <sub>zT</sub>	I <sub>zT</sub>	Z <sub>zK</sub>	I <sub>zK</sub>	I <sub>ZM</sub> @T <sub>a</sub>	I <sub>R</sub>	V <sub>R</sub>
		Nom.	Min	Max	(Ω)	(mA)	(Ω)	(mA)	(mA)	(μA)	(V)
ZD5229A	8D	4.3	4.21	4.39	22	20	2000	0.25	106	5.0	1.0
ZD5230A	8E	4.7	4.61	4.79	19	20	1900	0.25	97	5.0	2.0
ZD5231A	8F	5.1	5.00	5.20	17	20	1600	0.25	89	5.0	2.0
ZD5232A	8G	5.6	5.49	5.71	11	20	1600	0.25	81	5.0	3.0
ZD5233A	8H	6.0	5.88	6.12	7.0	20	1600	0.25	76	5.0	3.5
ZD5234A	8J	6.2	6.08	6.32	7.0	20	1000	0.25	73	5.0	4.0
ZD5235A	8K	6.8	6.66	6.94	5.0	20	750	0.25	67	3.0	5.0
ZD5236A	8L	7.5	7.35	7.65	6.0	20	500	0.25	61	3.0	6.0
ZD5237A	8M	8.2	8.04	8.36	8.0	20	500	0.25	55	3.0	6.5
ZD5238A	8N	8.7	8.53	8.87	8.0	20	600	0.25	55	3.0	6.5
ZD5239A	8P	9.1	8.92	9.28	10	20	600	0.25	50	3.0	7.0
ZD5240A	KF5	10	9.80	10.20	17	20	600	0.25	45	3.0	8.0
ZD5241A	8R	11	10.78	11.22	22	20	600	0.25	41	2.0	8.4
ZD5242A	8S	12	11.76	12.24	30	20	600	0.25	38	1.0	9.1
ZD5243A	8T	13	12.74	13.26	13	9.5	600	0.25	35	0.5	9.9
ZD5245A	8V	15	14.70	15.30	16	8.5	600	0.25	30	0.1	11
ZD5246A	8W	16	15.68	16.32	17	7.8	600	0.25	28	0.1	12



**Electrical Characteristic(Cont.)**

Device	Type Code	Nom. Zener Voltage			Max. Zener Impedance				Max. Zener Current	Max. Reverse Leakage Current	
		Vz@IzT(V)			ZzT	IzT	ZzK	IzK	IzM@Ta	IR	VR
		Nom.	Min	Max	(Ω)	(mA)	(Ω)	(mA)	(mA)	(μA)	(V)
ZD5248A	8Y	18	17.64	18.36	21	7.0	600	0.25	25	0.1	14
ZD5250A	81A	20	19.60	20.40	25	6.2	600	0.25	23	0.1	15
ZD5251A	81B	22	21.56	22.44	29	5.6	600	0.25	21	0.1	17
ZD5252A	81C	24	23.52	24.48	33	5.2	600	0.25	19.1	0.1	18
ZD5254A	81E	27	26.46	27.54	41	5.0	600	0.25	16.8	0.1	21
ZD5255A	81F	28	27.44	28.56	44	4.5	600	0.25	16.2	0.1	21
ZD5256A	81G	30	29.40	30.60	49	4.2	600	0.25	15.1	0.1	23
ZD5257A	81H	33	32.34	33.66	58	3.8	700	0.25	13.8	0.1	25
ZD5258A	81J	36	35.28	36.72	70	3.4	700	0.25	12.6	0.1	27
ZD5259A	81K	39	38.22	39.78	80	3.2	800	0.25	11.6	0.1	30
ZD5260A	81L	43	42.14	43.86	93	3	900	0.25	10.6	0.1	33

\* The Vz tolerance is ±2%.

**Typical Characteristics**

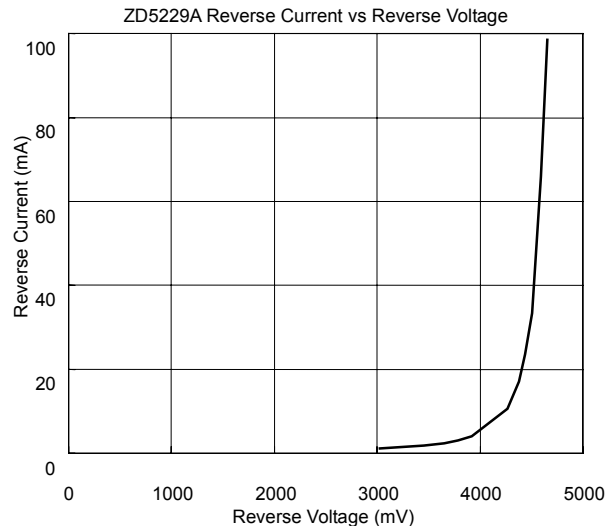
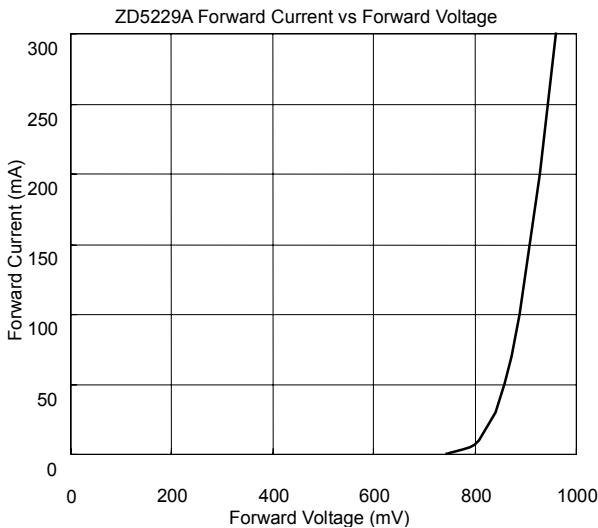

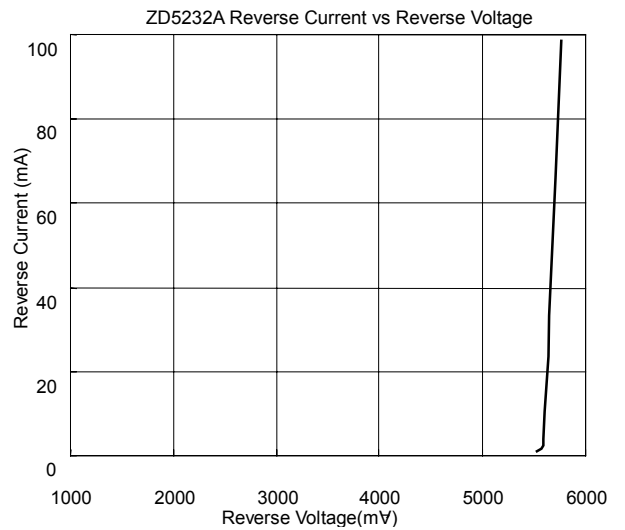
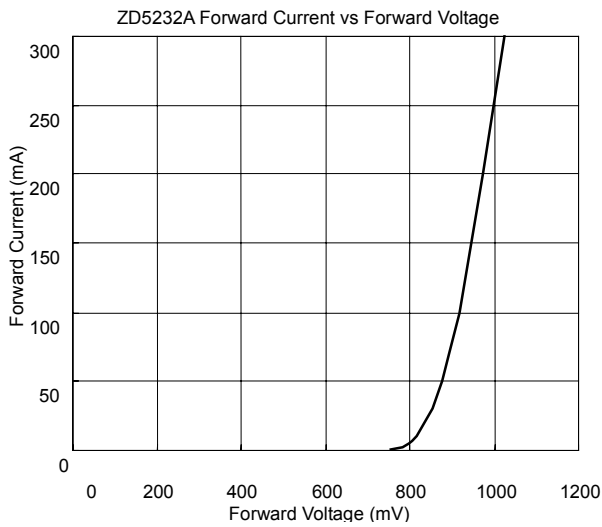
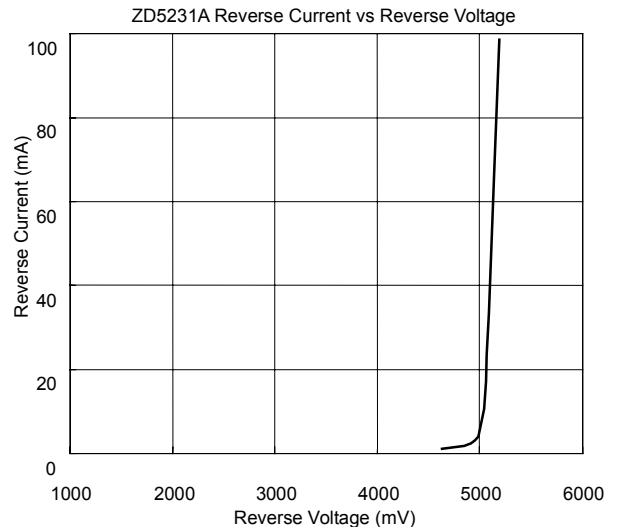
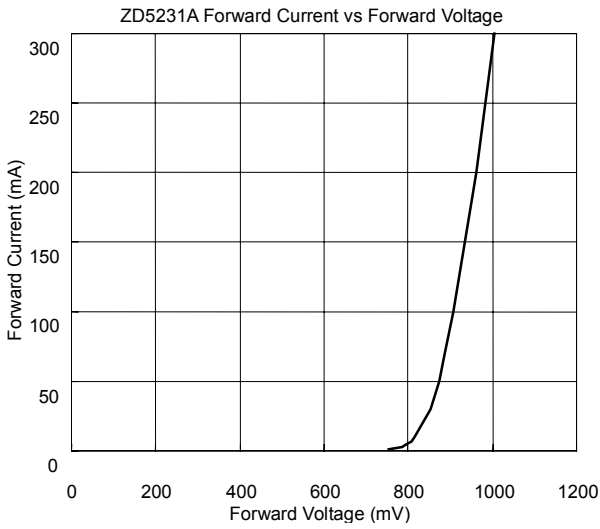
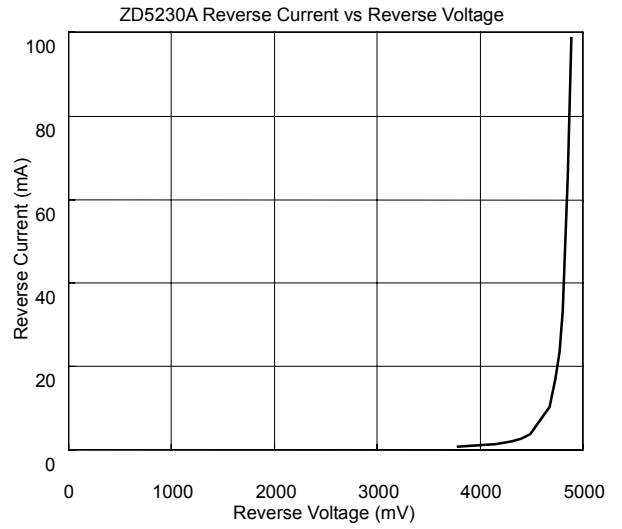
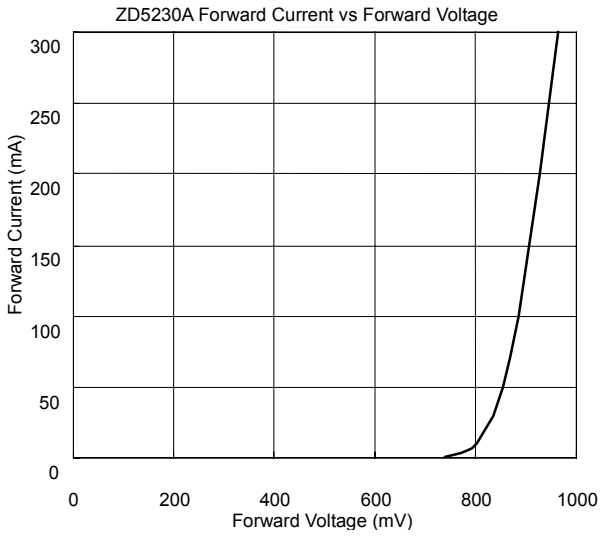

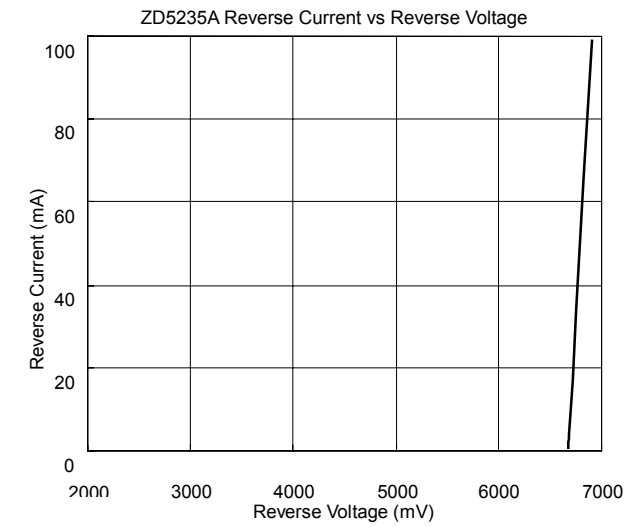
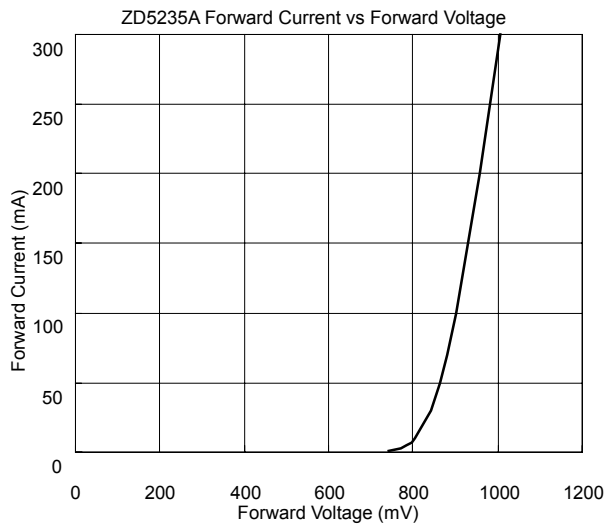
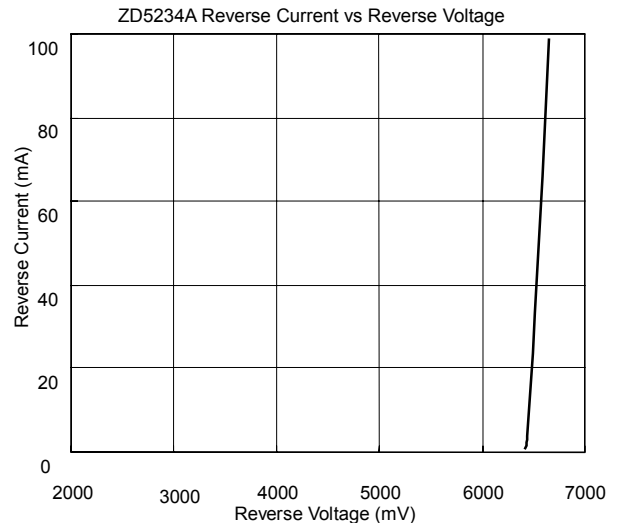
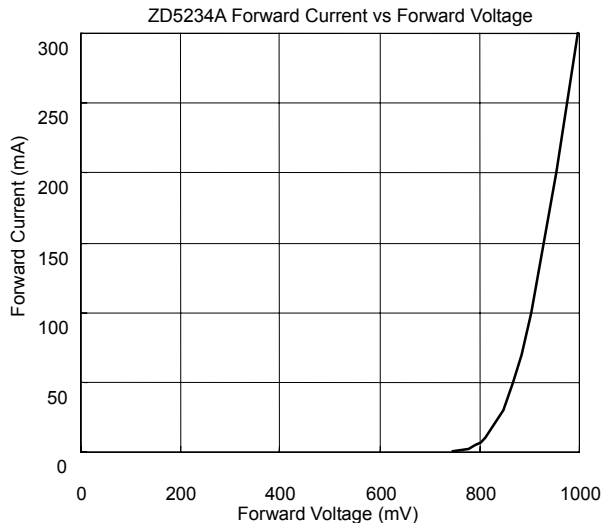
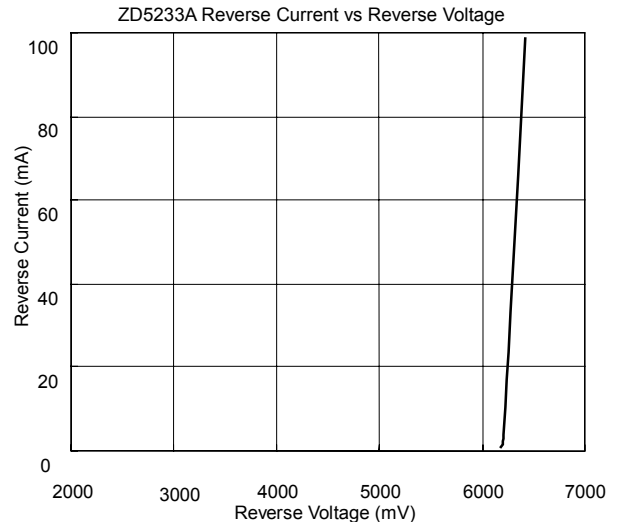
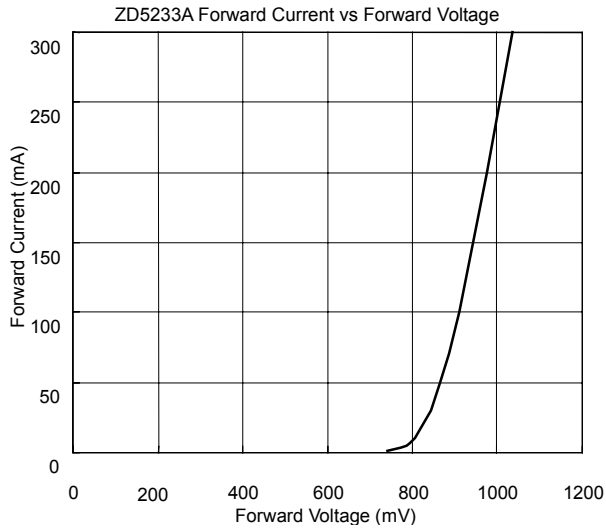

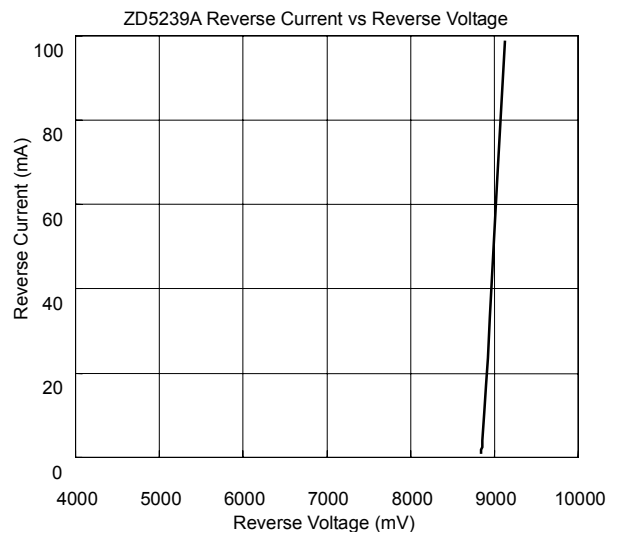
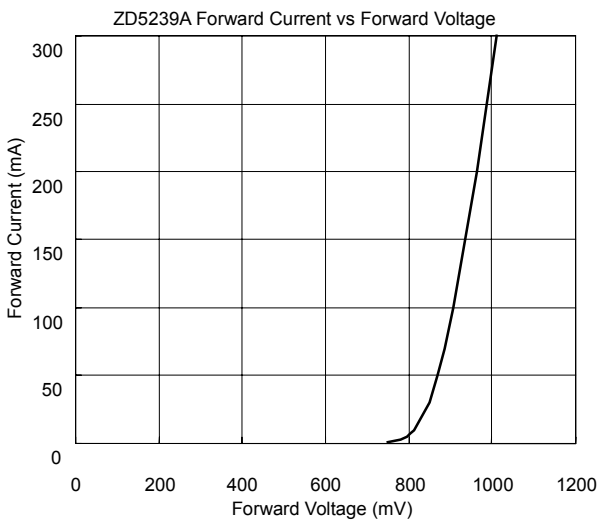
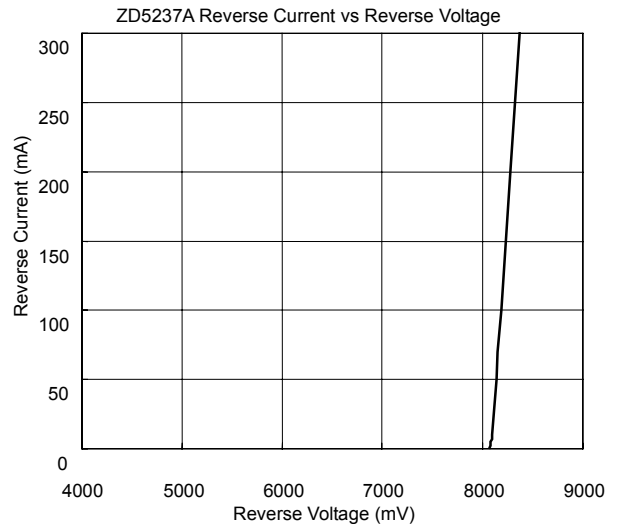
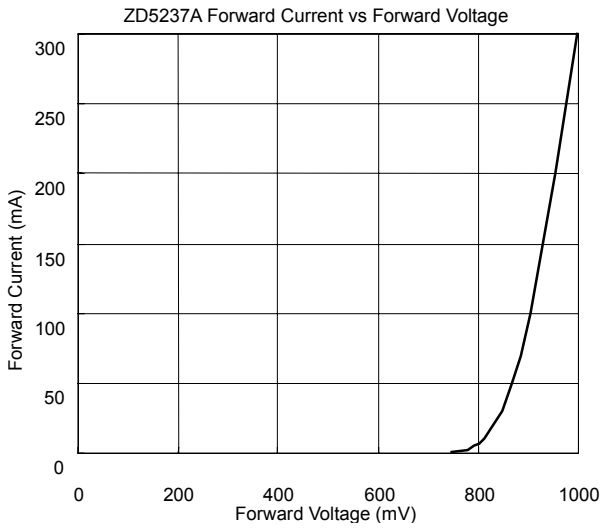
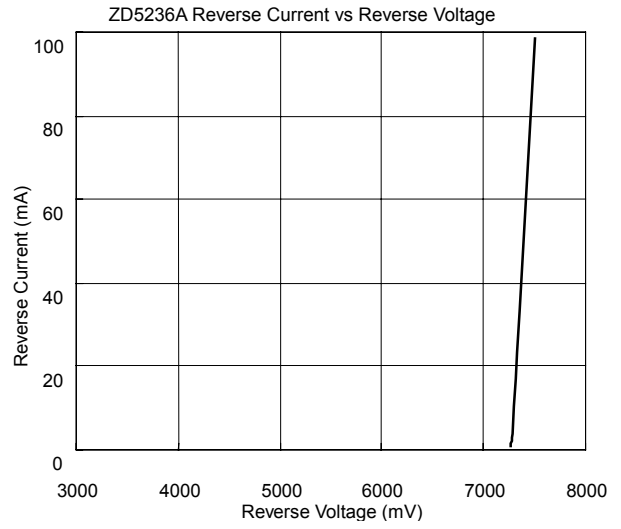
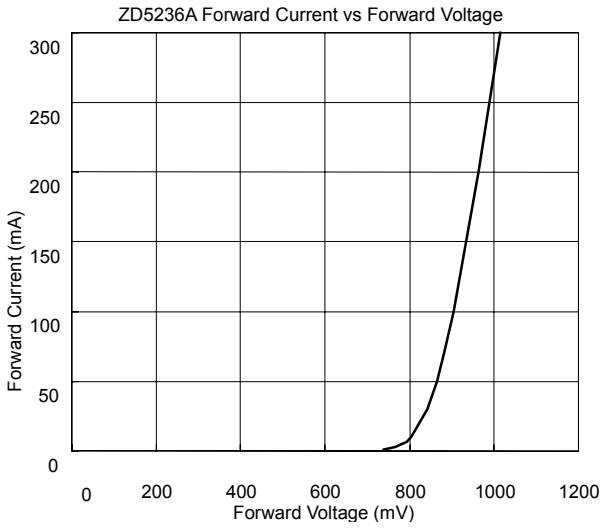

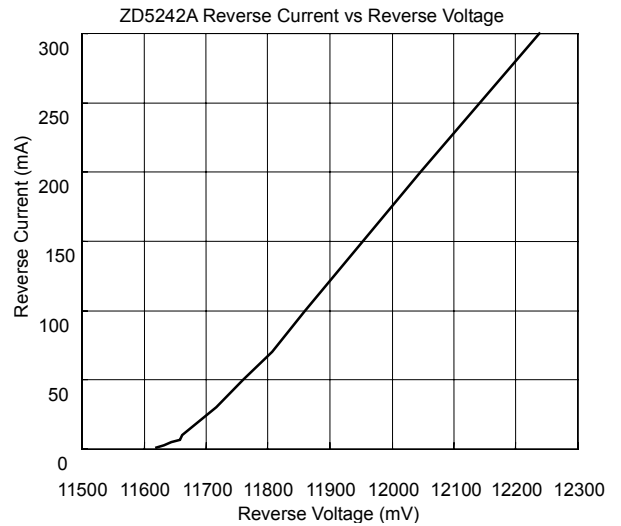
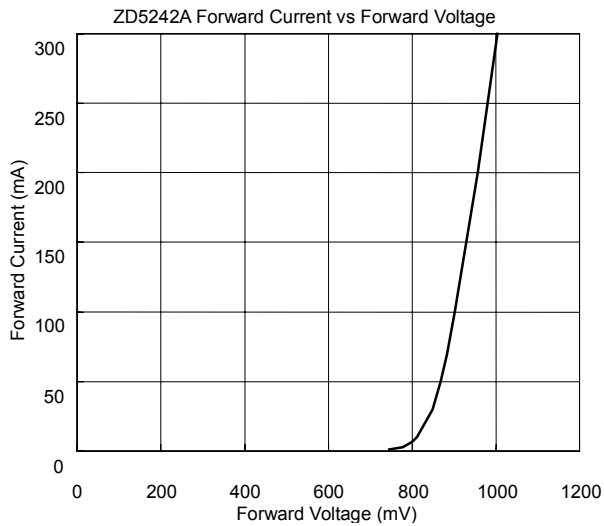
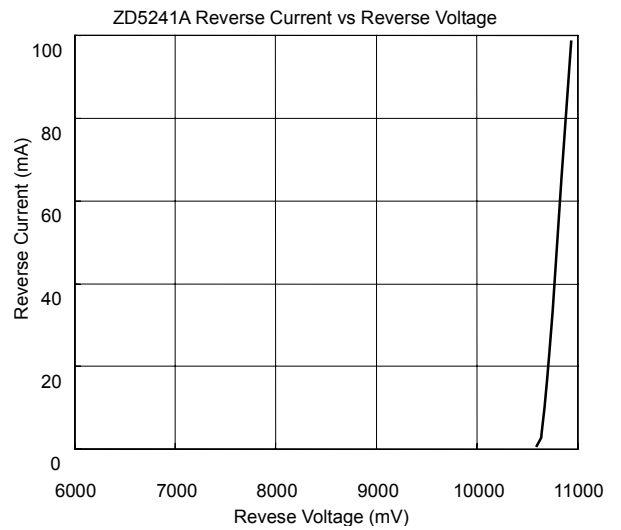
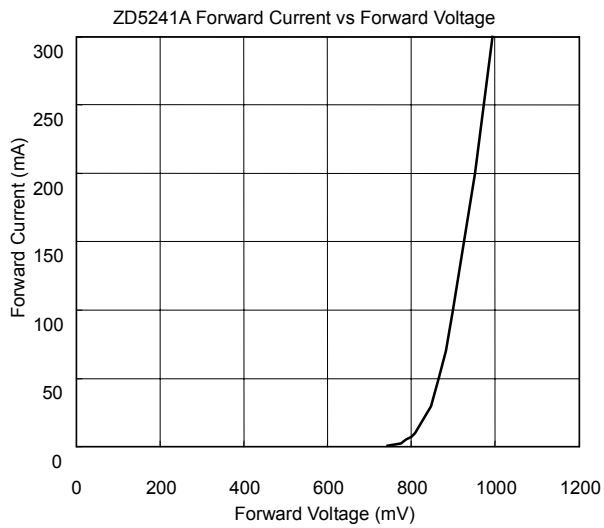
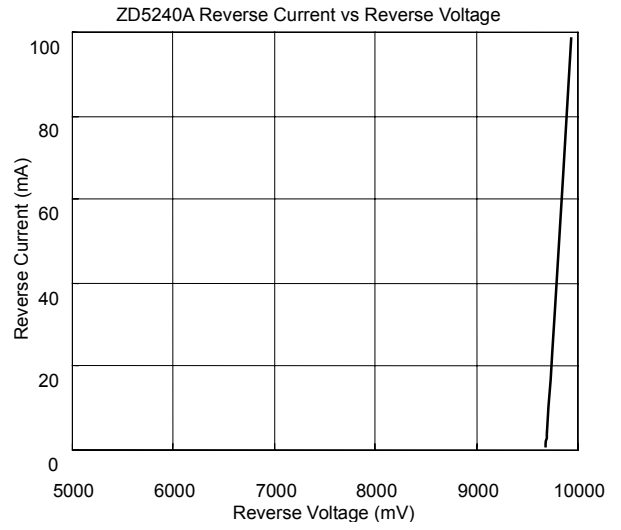
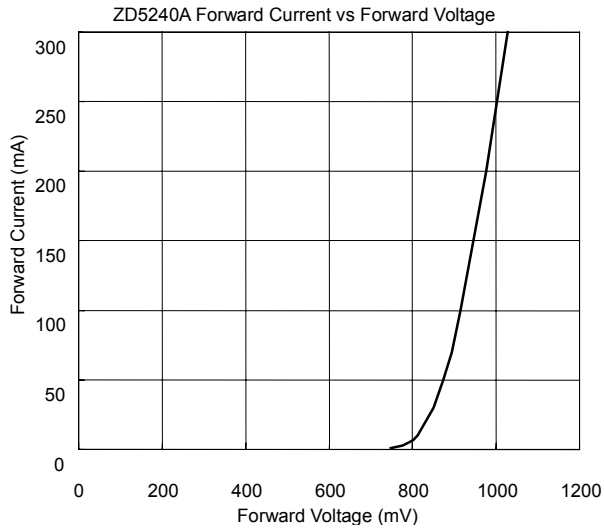

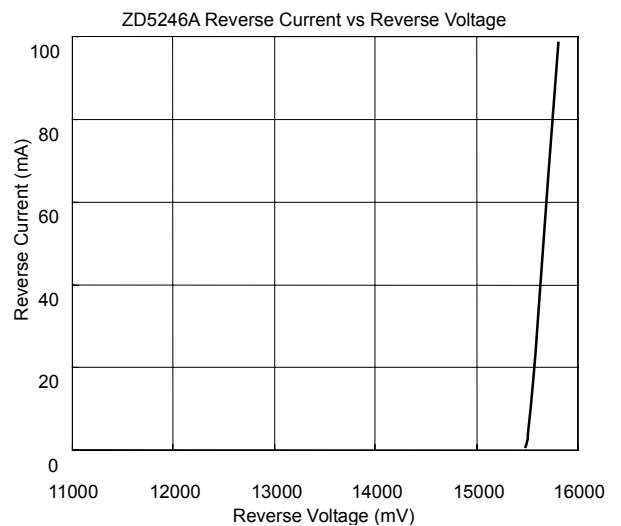
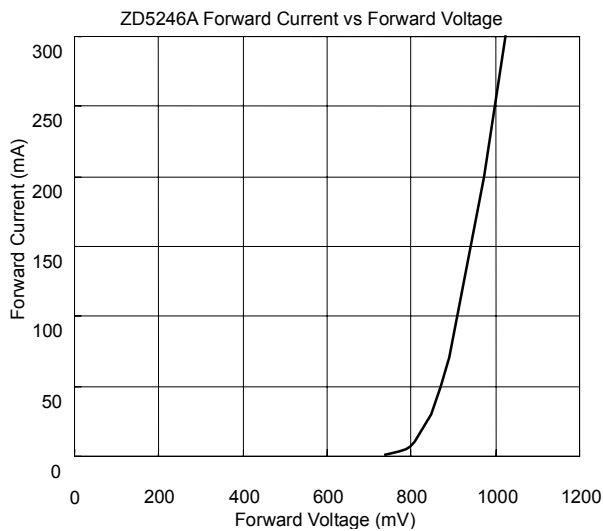
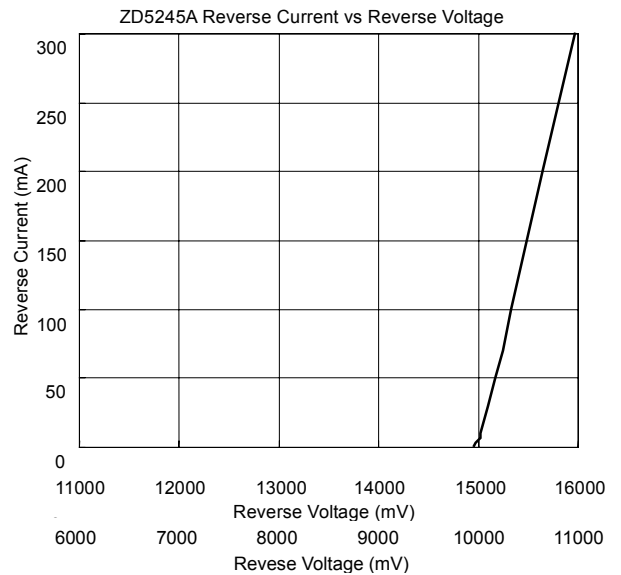
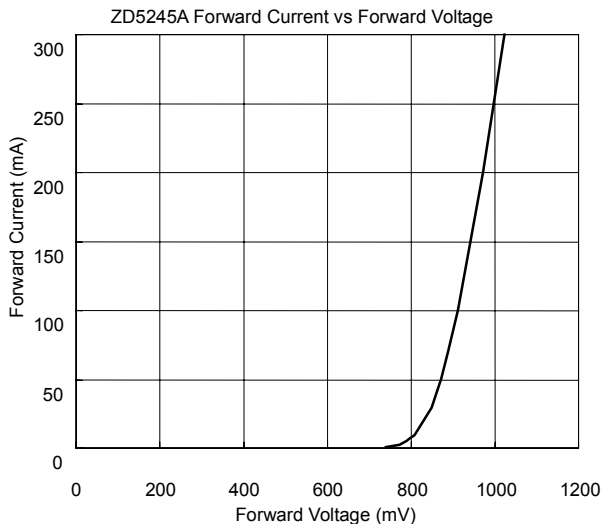
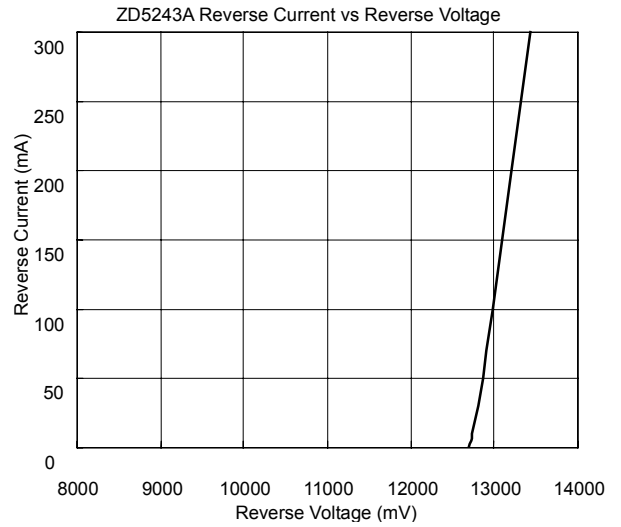
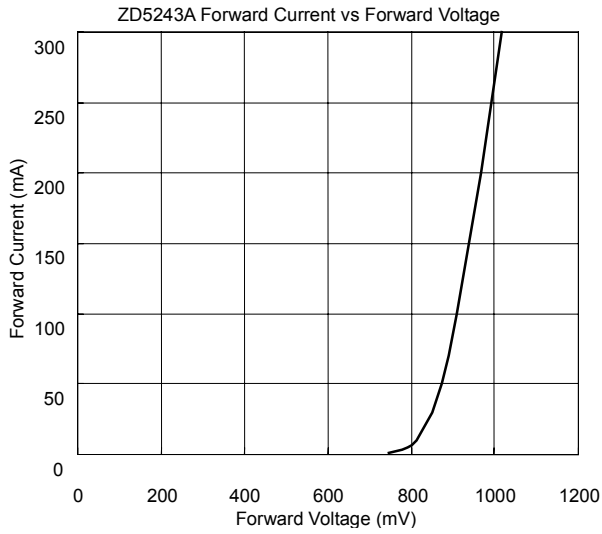

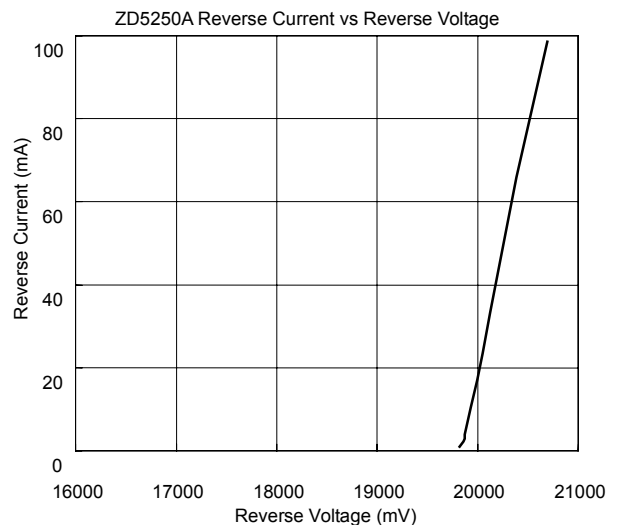
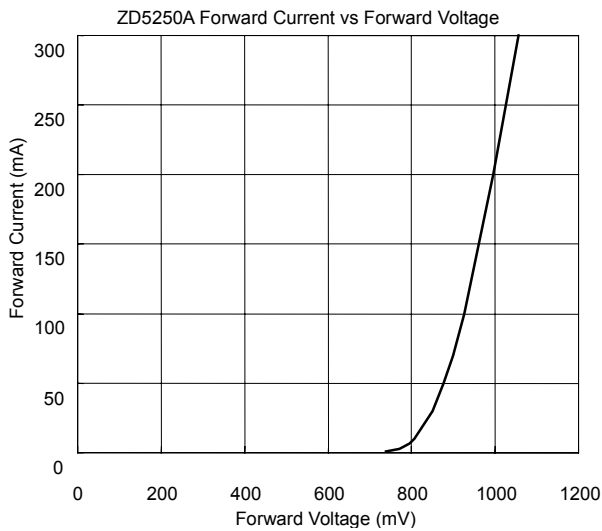
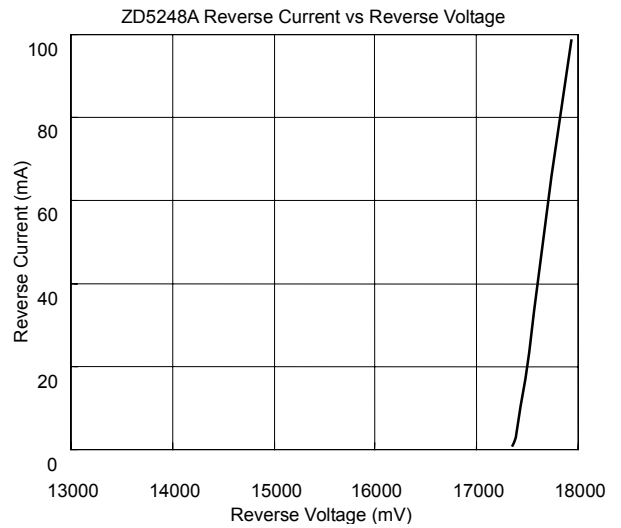
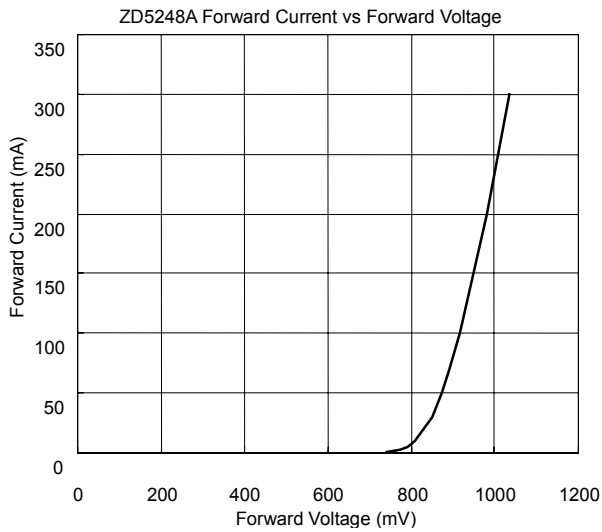
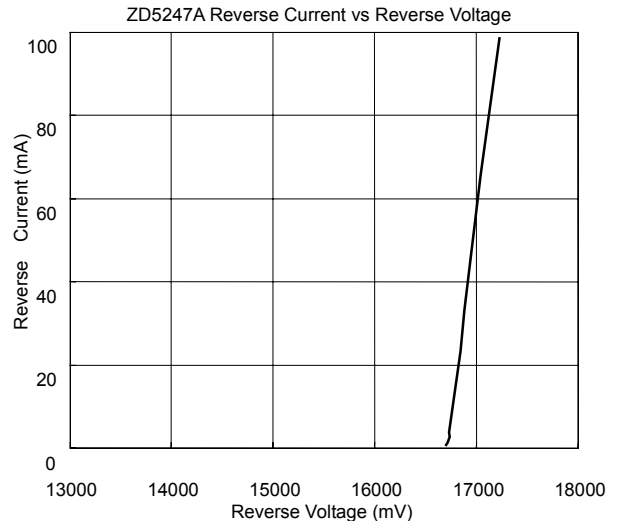
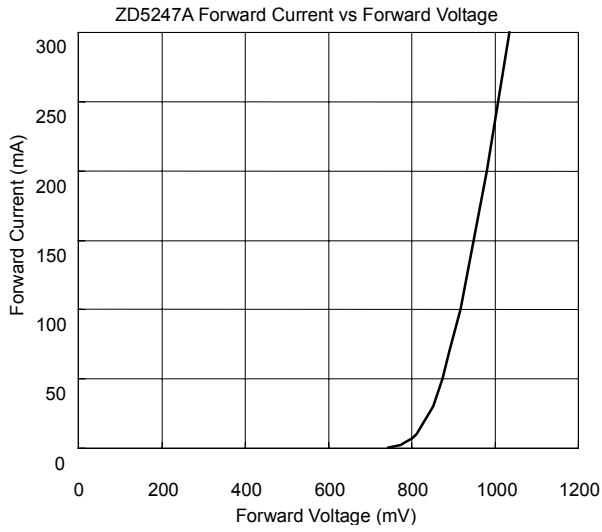



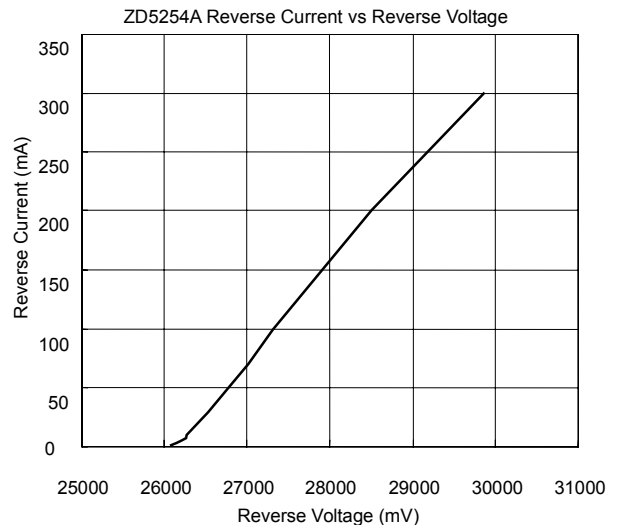
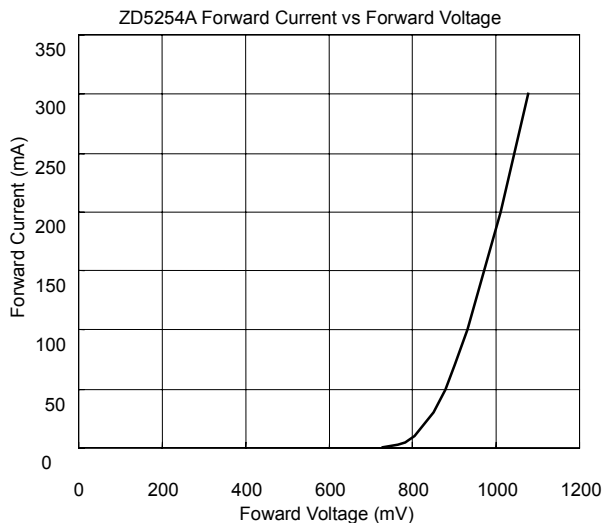
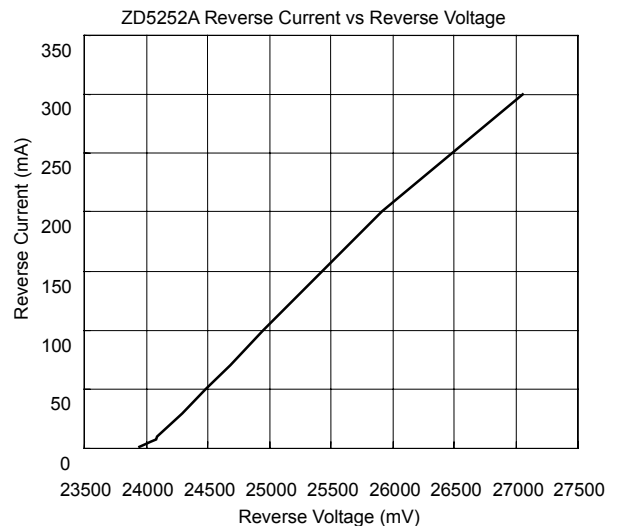
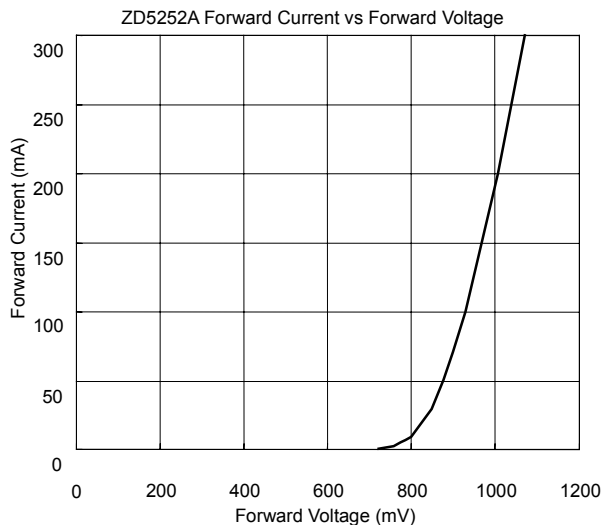
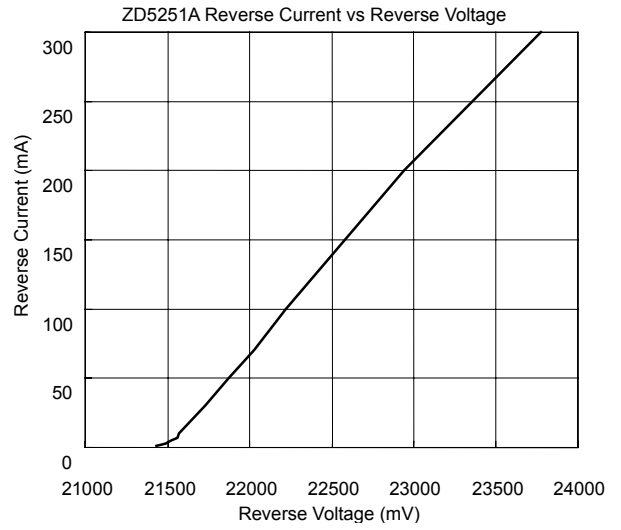
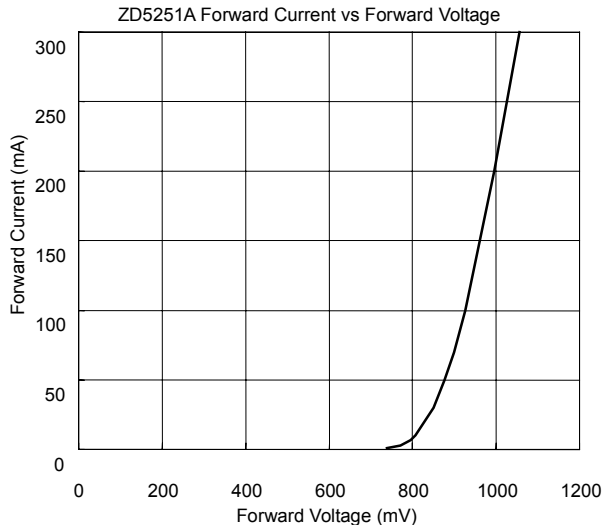

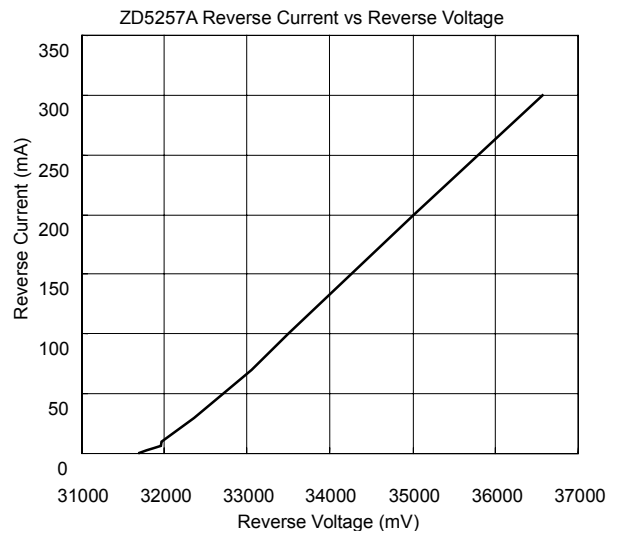
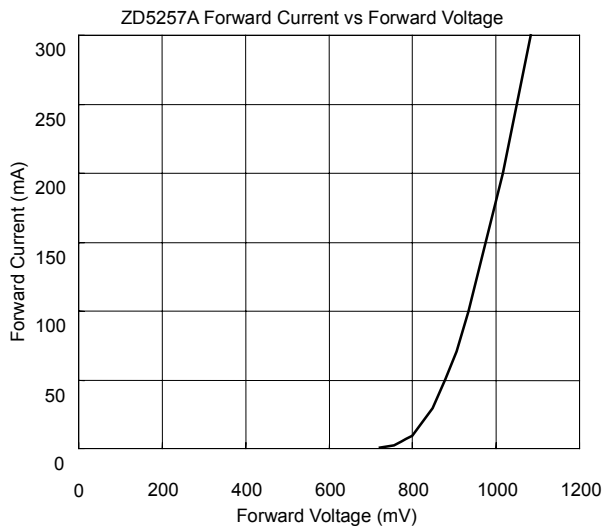
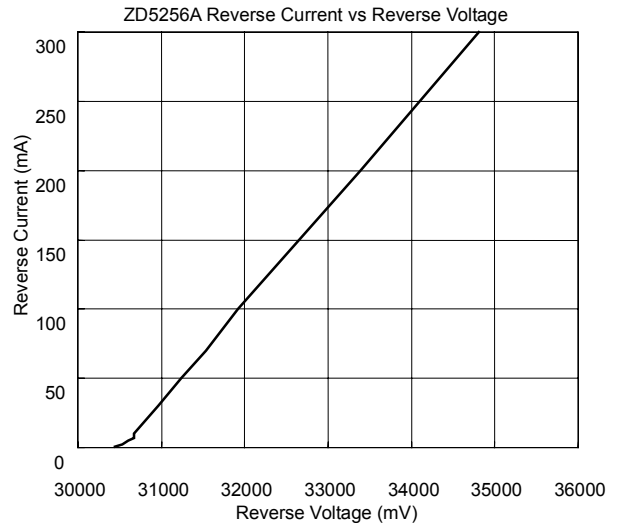
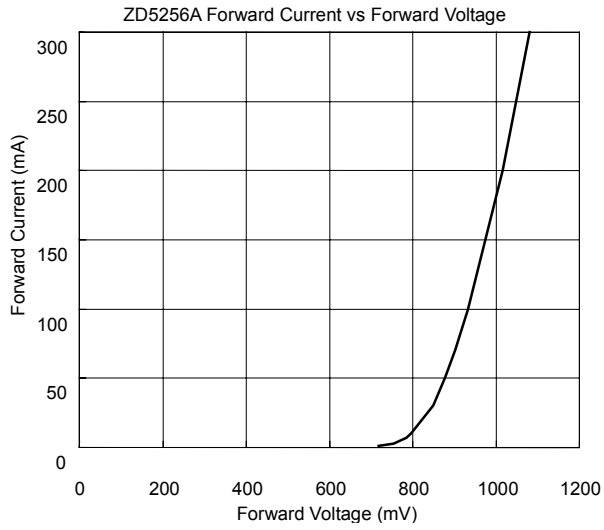

### Recommended Footprint

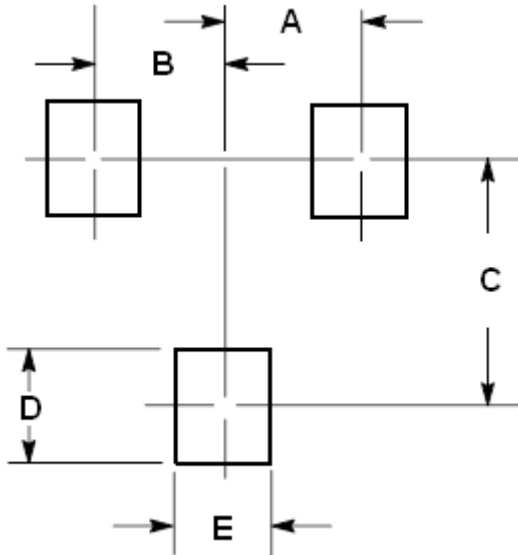

DIM	Inches	Millimeters
	Typ	Typ
A	0.039	1.0
B	0.039	1.0
C	0.079	2.0
D	0.035	0.9
E	0.031	0.8

### Ordering Information

Device	Package	Shipping
ZD52XXAN3-0-T1-G	SOT-23 (Pb-free lead plating and halogen-free package)	3000 pcs / Tape & Reel

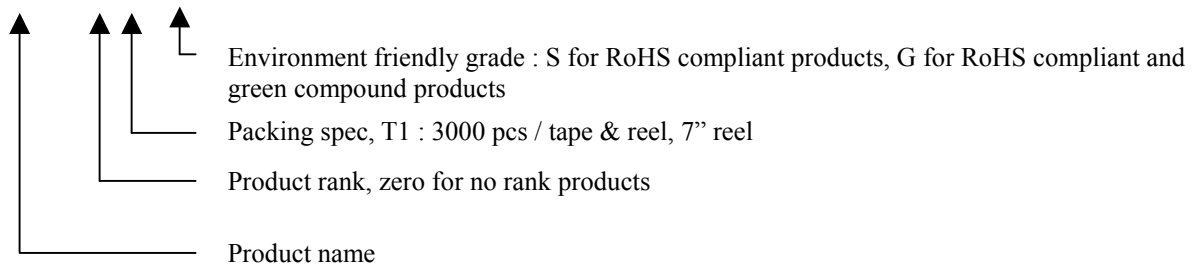

**Reel Dimension**

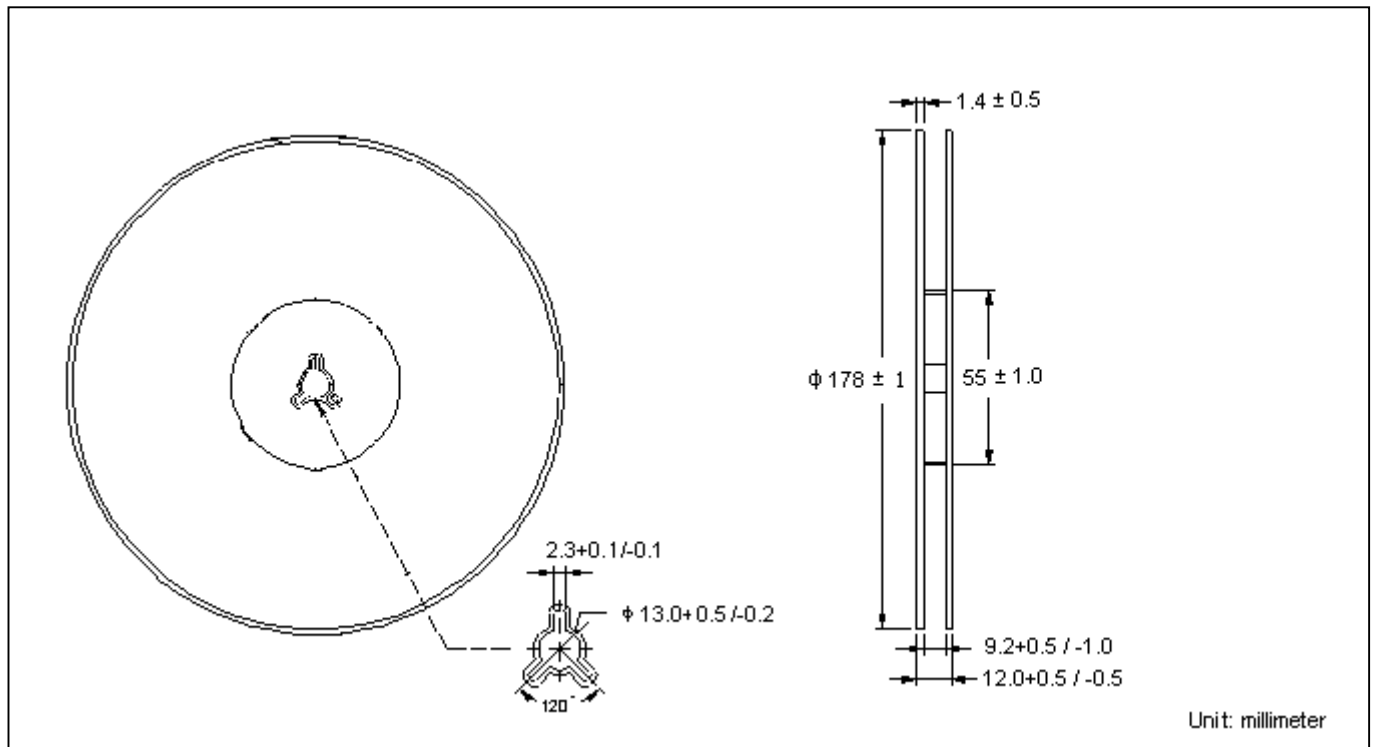

**Carrier Tape Dimension**

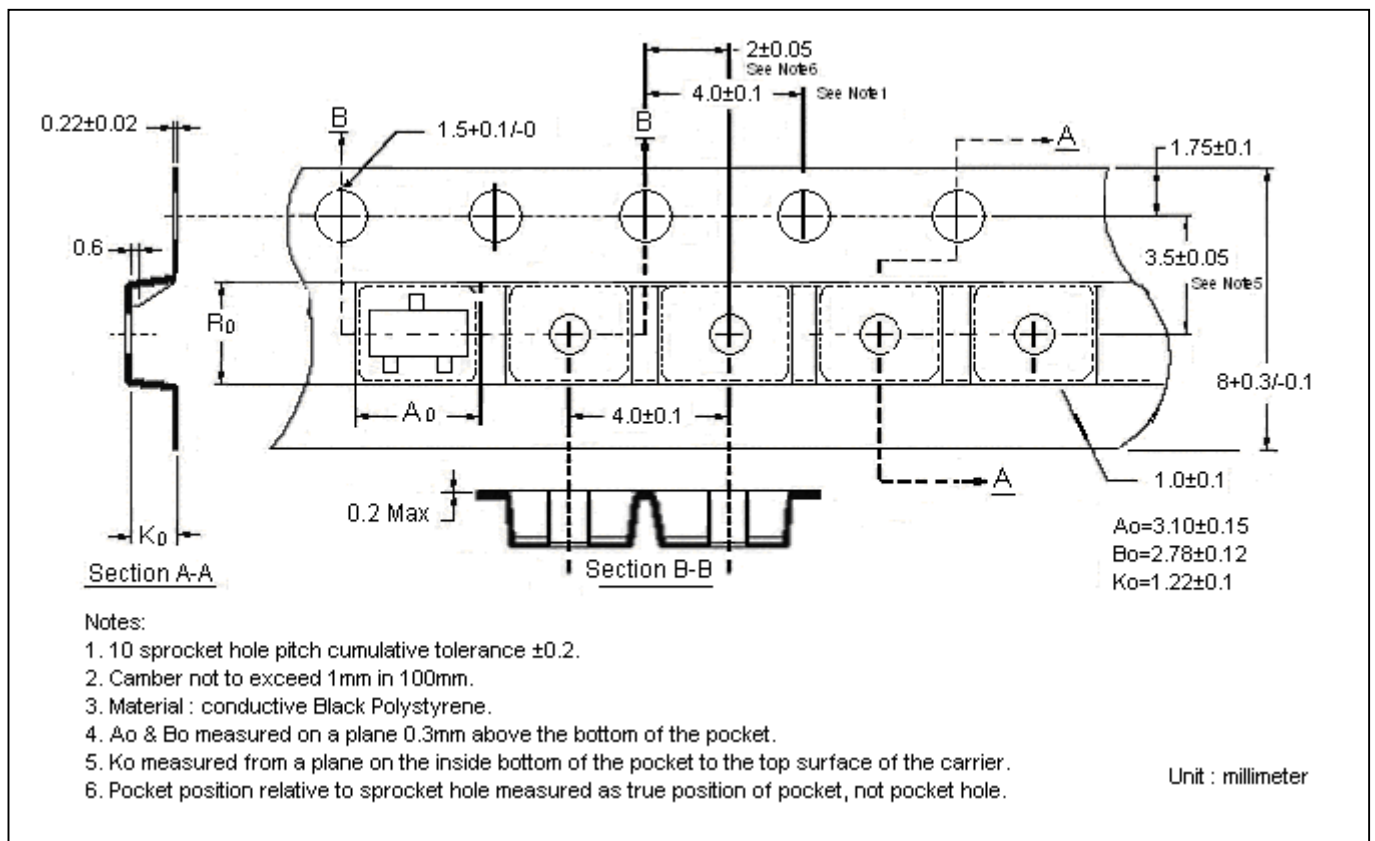

**Recommended wave soldering condition**

Product	Peak Temperature	Soldering Time
Pb-free devices	260 +0/-5 °C	5 +1/-1 seconds

**Recommended temperature profile for IR reflow**

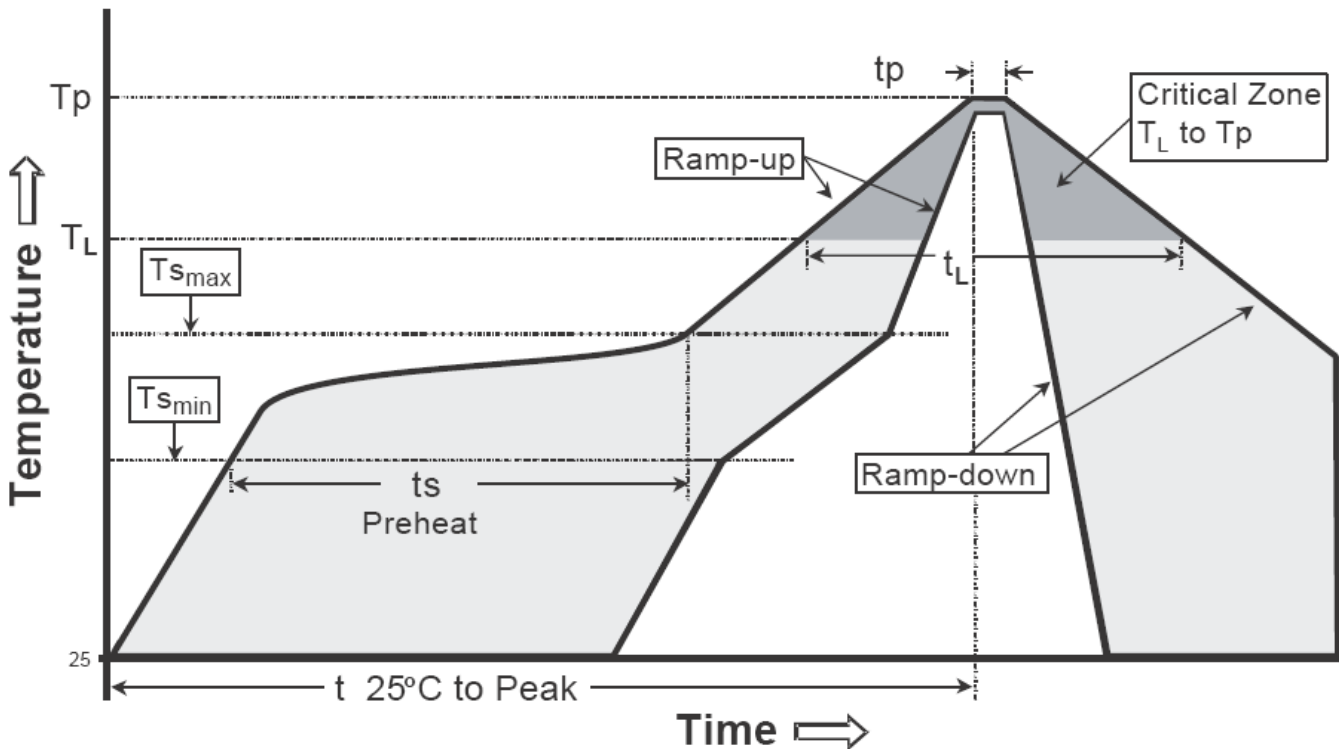

Profile feature	Sn-Pb eutectic Assembly	Pb-free Assembly
Average ramp-up rate (Tsmax to Tp)	3°C/second max.	3°C/second max.
Preheat		
-Temperature Min(Ts min)	100°C	150°C
-Temperature Max(Ts max)	150°C	200°C
-Time(ts min to ts max)	60-120 seconds	60-180 seconds
Time maintained above:		
-Temperature (Tl)	183°C	217°C
- Time (tl)	60-150 seconds	60-150 seconds
Peak Temperature(Tp)	240 +0/-5 °C	260 +0/-5 °C
Time within 5°C of actual peak temperature(tp)	10-30 seconds	20-40 seconds
Ramp down rate	6°C/second max.	6°C/second max.
Time 25 °C to peak temperature	6 minutes max.	8 minutes max.

Note : All temperatures refer to topside of the package, measured on the package body surface.

**SOT-23 Dimension**

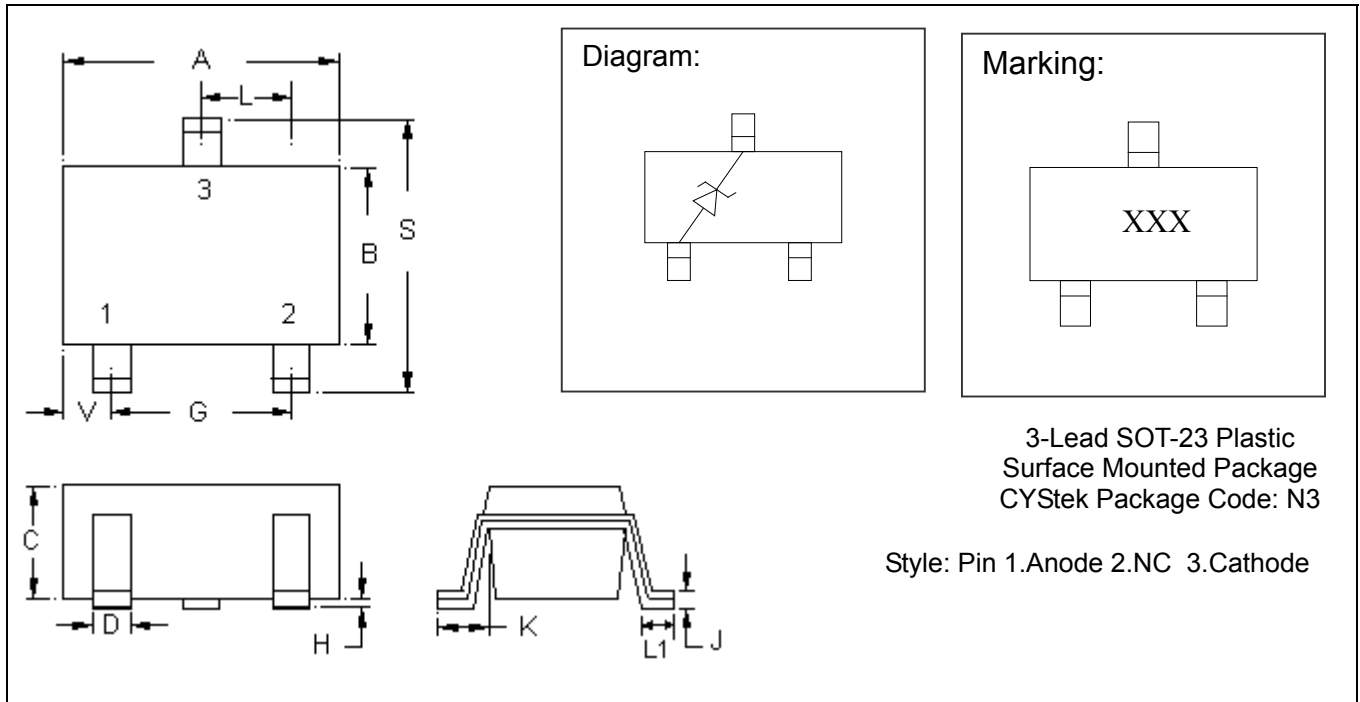

The diagram shows the SOT-23 package with dimensions A through V. It includes a top view with dimensions A, L, B, S, 1, 2, 3, V, and G. A side view shows dimensions C, D, H, and J. A perspective view shows dimensions K, L1, and L2. A schematic diagram shows the package with a diode symbol. A marking diagram shows the package with 'XXX' marking.

**Diagram:**

**Marking:**

3-Lead SOT-23 Plastic Surface Mounted Package  
 CYStek Package Code: N3

Style: Pin 1. Anode 2. NC 3. Cathode

\*: Typical

DIM	Inches		Millimeters		DIM	Inches		Millimeters	
	Min.	Max.	Min.	Max.		Min.	Max.	Min.	Max.
A	0.1102	0.1204	2.80	3.04	J	0.0032	0.0079	0.08	0.20
B	0.0472	0.0551	1.20	1.40	K	0.0118	0.0266	0.30	0.67
C	0.0335	0.0512	0.89	1.30	L	0.0335	0.0453	0.85	1.15
D	0.0118	0.0197	0.30	0.50	S	0.0830	0.1004	2.10	2.55
G	0.0669	0.0910	1.70	2.30	V	0.0098	0.0256	0.25	0.65
H	0.0000	0.0040	0.00	0.10	L1	0.0118	0.0197	0.30	0.50

**Notes:** 1. Controlling dimension: millimeters.  
 2. Maximum lead thickness includes lead finish thickness, and minimum lead thickness is the minimum thickness of base material.  
 3. If there is any question with packing specification or packing method, please contact your local CYStek sales office.

**Material:**

- Lead: Pure tin plated.
- Mold Compound: Epoxy resin family, flammability solid burning class: UL94V-0.

**Important Notice:**

- All rights are reserved. Reproduction in whole or in part is prohibited without the prior written approval of CYStek.
- CYStek reserves the right to make changes to its products without notice.
- CYStek **semiconductor products are not warranted to be suitable for use in Life-Support Applications, or systems.**
- CYStek assumes no liability for any consequence of customer product design, infringement of patents, or application assistance.