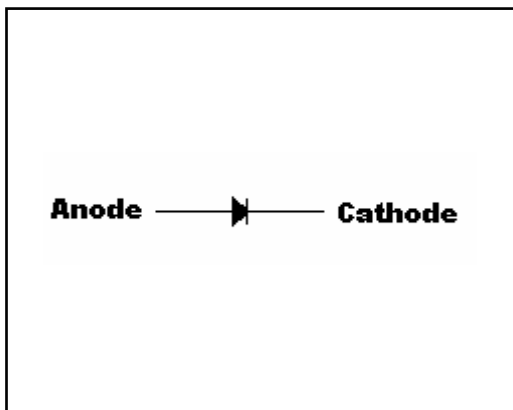
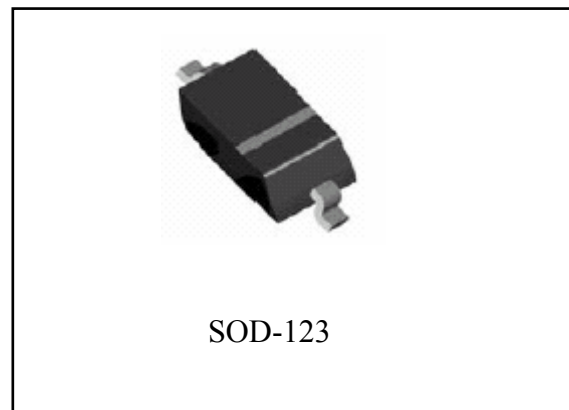

500mW Zener Diode Series**ZD46XXSH****Description**

The ZD46XXSH series covers zener voltage range from 1.8V to 43V, and is encapsulated in SOD-123 package, very suitable for low cost, low power voltage regulation application.

Features

- Ultra small surface mount package
- General purpose, medium current
- Planar die construction
- Pb-free package

Symbol**Outline****Ordering Information**

Device	Package	Shipping
ZD46XXSH-0-T1-G	SOD-123 (Pb-free lead plating and halogen-free package)	3000 pcs / Tape & Reel

Absolute Maximum Ratings($T_j=25^{\circ}\text{C}$, unless otherwise specified)

- Maximum Temperatures
 Operating and Storage Temperature Range T_j, T_{stg} $-65\sim+150^{\circ}\text{C}$
- Maximum Forward Voltage @ $I_F=10\text{mA}$ 0.9V
- Maximum Power Dissipation
 Total Power Dissipation @ $T_L=75^{\circ}\text{C}$ P_{tot} (Note 1) 500mW
- Thermal Resistance, Junction to Ambient Air $R_{\theta JL}$ (Note 1)..... 150°C/W
- Maximum Z-current..... $P_{tot}/V_Z\text{ mA}$

Note : 1. Parts mounted on FR-5 board with area of $3.5\text{inch} \times 1.5\text{inch}$.

Electrical Characteristic ($T_a=25^{\circ}\text{C}$, unless otherwise noted)

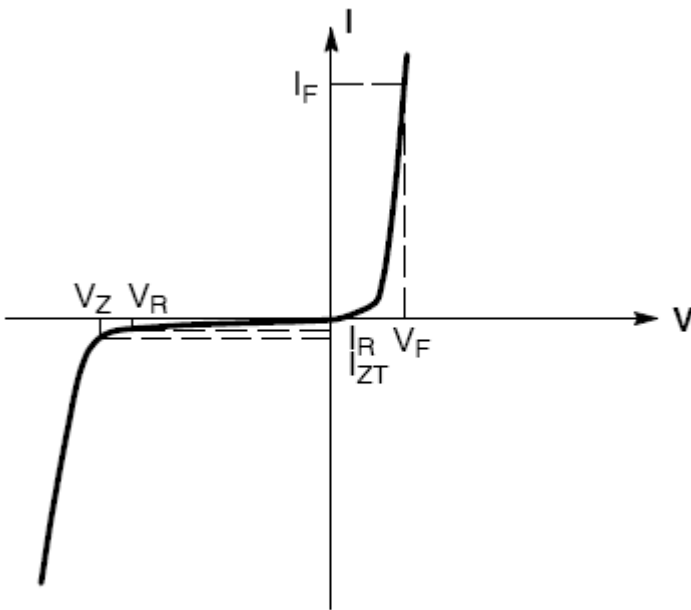

Zener Voltage Regulator

Symbol	Parameter
V_Z	Reverse zener voltage @ I_{ZT}
I_{ZT}	Reverse current
I_R	Reverse leakage current @ V_R
V_R	Reverse voltage
I_F	Forward current
V_F	Forward voltage @ I_F



Device	Type Code	Nom. Zener Voltage				Max. Reverse Leakage Current	
		V _Z @I _{ZT}				I _R (μA)	V _R (V)
		Min. (V)	Nom. (V)	Max. (V)	I _{ZT} (μA)		
ZD4678	CC	1.71	1.8	1.89	50	7.5	1
ZD4679	CD	1.90	2.0	2.10	50	5	1
ZD4680	CE	2.09	2.2	2.31	50	4	1
ZD4681	CF	2.28	2.4	2.52	50	2	1
ZD4682	CH	2.565	2.7	2.835	50	1	1
ZD4683	CJ	2.85	3.0	3.15	50	0.8	1
ZD4684	CK	3.13	3.3	3.47	50	7.5	1.5
ZD4685	CM	3.42	3.6	3.78	50	7.5	2
ZD4686	CN	3.70	3.9	4.10	50	5	2
ZD4687	CP	4.09	4.3	4.52	50	4	2
ZD4688	CT	4.47	4.7	4.94	50	10	3
ZD4689	CU	4.85	5.1	5.36	50	10	3
ZD4690	CV	5.32	5.6	5.88	50	10	4
ZD4691	CA	5.89	6.2	6.51	50	10	5
ZD4692	CX	6.46	6.8	7.14	50	10	5.1
ZD4693	CY	7.13	7.5	7.88	50	10	5.7
ZD4694	CZ	7.79	8.2	8.61	50	1	6.2
ZD4695	DC	8.27	8.7	9.14	50	1	6.6
ZD4696	DD	8.65	9.1	9.56	50	1	6.9
ZD4697	DE	9.50	10	10.5	50	1	7.6
ZD4698	DF	10.45	11	11.55	50	0.05	8.4
ZD4699	DH	11.40	12	12.60	50	0.05	9.1
ZD4700	DJ	12.35	13	13.65	50	0.05	9.8
ZD4701	DK	13.30	14	14.70	50	0.05	10.6
ZD4702	DM	14.25	15	15.75	50	0.05	11.4
ZD4703	DN	15.20	16	16.80	50	0.05	12.1
ZD4704	DP	16.15	17	17.85	50	0.05	12.9
ZD4705	DT	17.10	18	18.90	50	0.05	13.6
ZD4706	DU	18.05	19	19.95	50	0.05	14.4
ZD4707	DV	19.00	20	21.00	50	0.01	15.2
ZD4708	DA	20.90	22	23.10	50	0.01	16.7
ZD4709	DX	22.80	24	25.20	50	0.01	18.2
ZD4710	DY	23.75	25	26.25	50	0.01	19.0
ZD4711	EA	25.65	27	28.35	50	0.01	20.4
ZD4712	EC	26.60	28	29.40	50	0.01	21.2
ZD4713	ED	28.50	30	31.50	50	0.01	22.8
ZD4714	EE	31.35	33	34.65	50	0.01	25.0
ZD4715	EF	34.20	36	37.80	50	0.01	27.3
ZD4716	EH	37.05	39	40.95	50	0.01	29.6
ZD4717	EJ	40.85	43	45.15	50	0.01	32.6



Characteristic Curves

ZD4686

Reverse Leakage Current vs Reverse Voltage

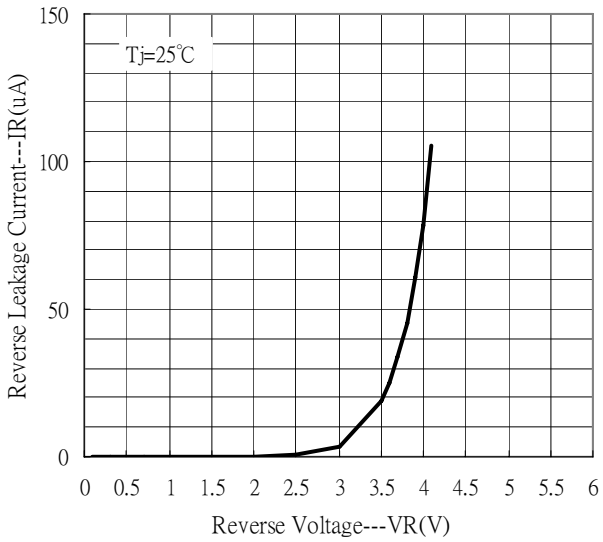

Forward Current vs Forward Voltage

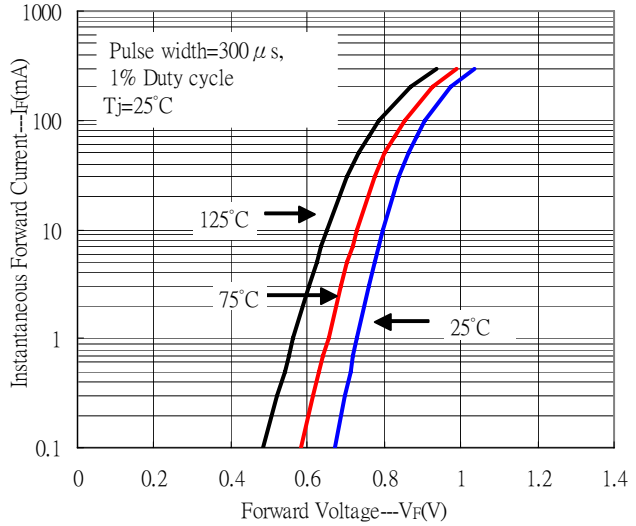

Junction Capacitance vs Reverse Voltage

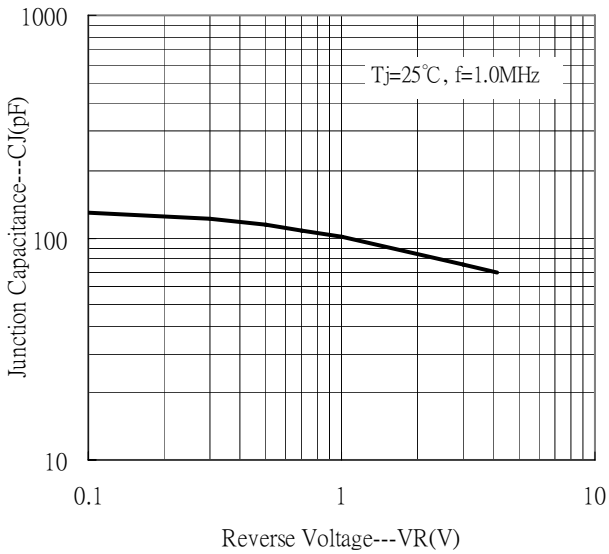

ZD4687

Reverse Leakage Current vs Reverse Voltage

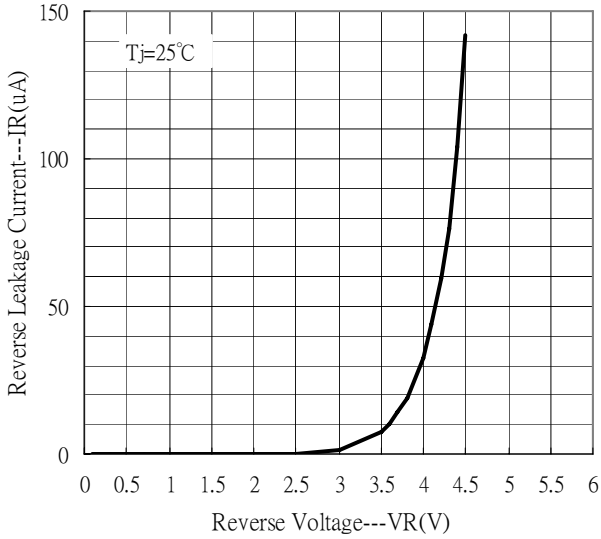

Forward Current vs Forward Voltage

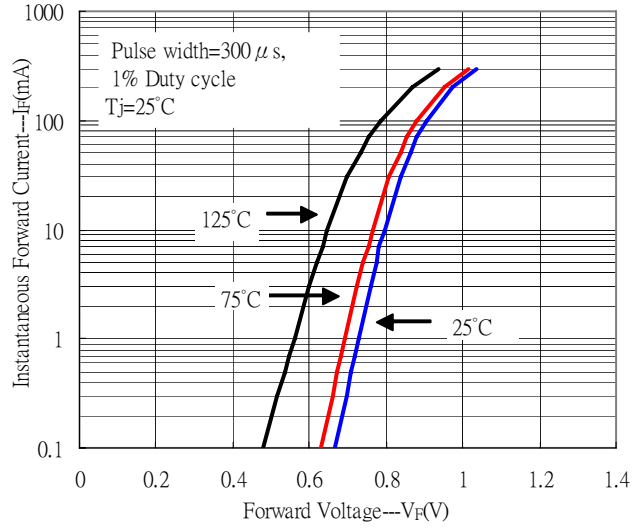

Junction Capacitance vs Reverse Voltage

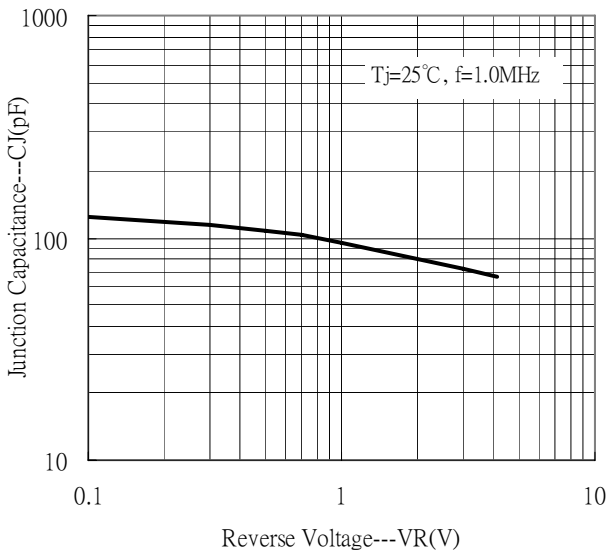

Reel Dimension

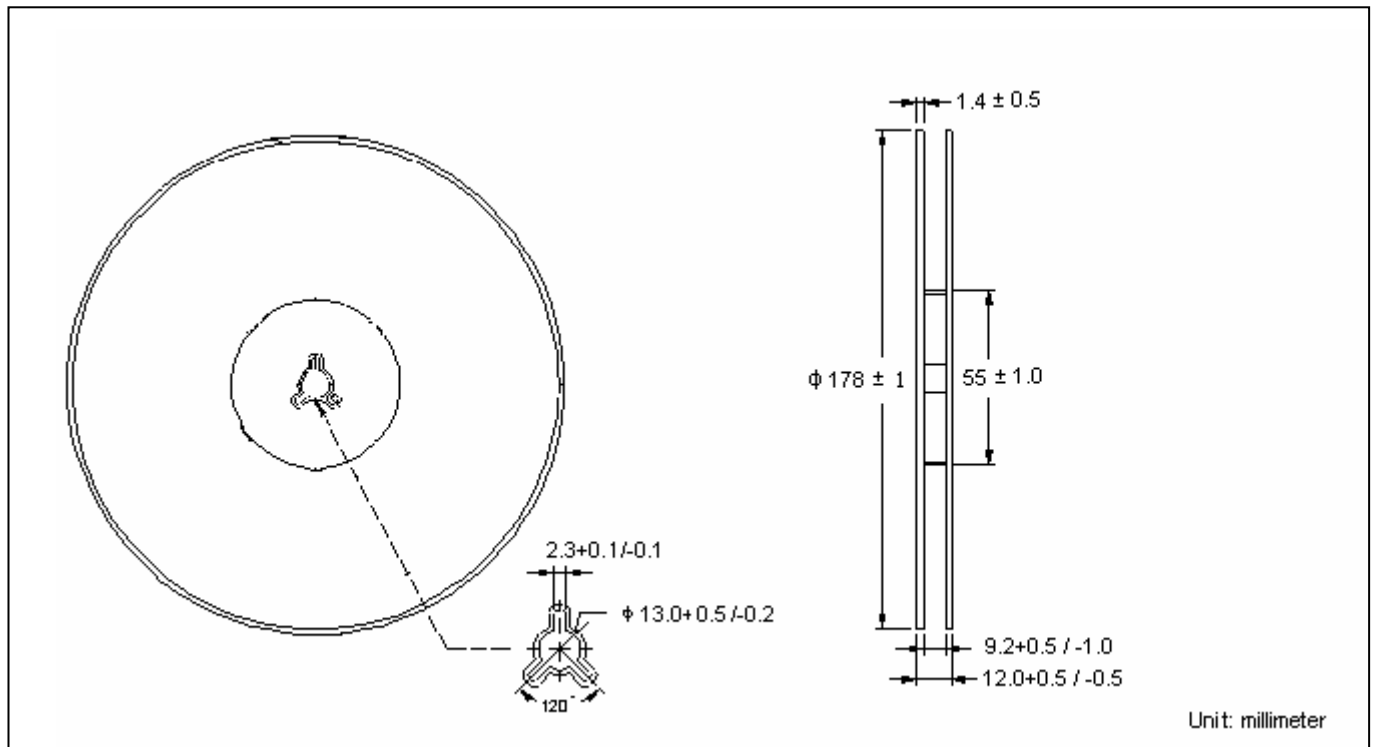

Carrier Tape Dimension

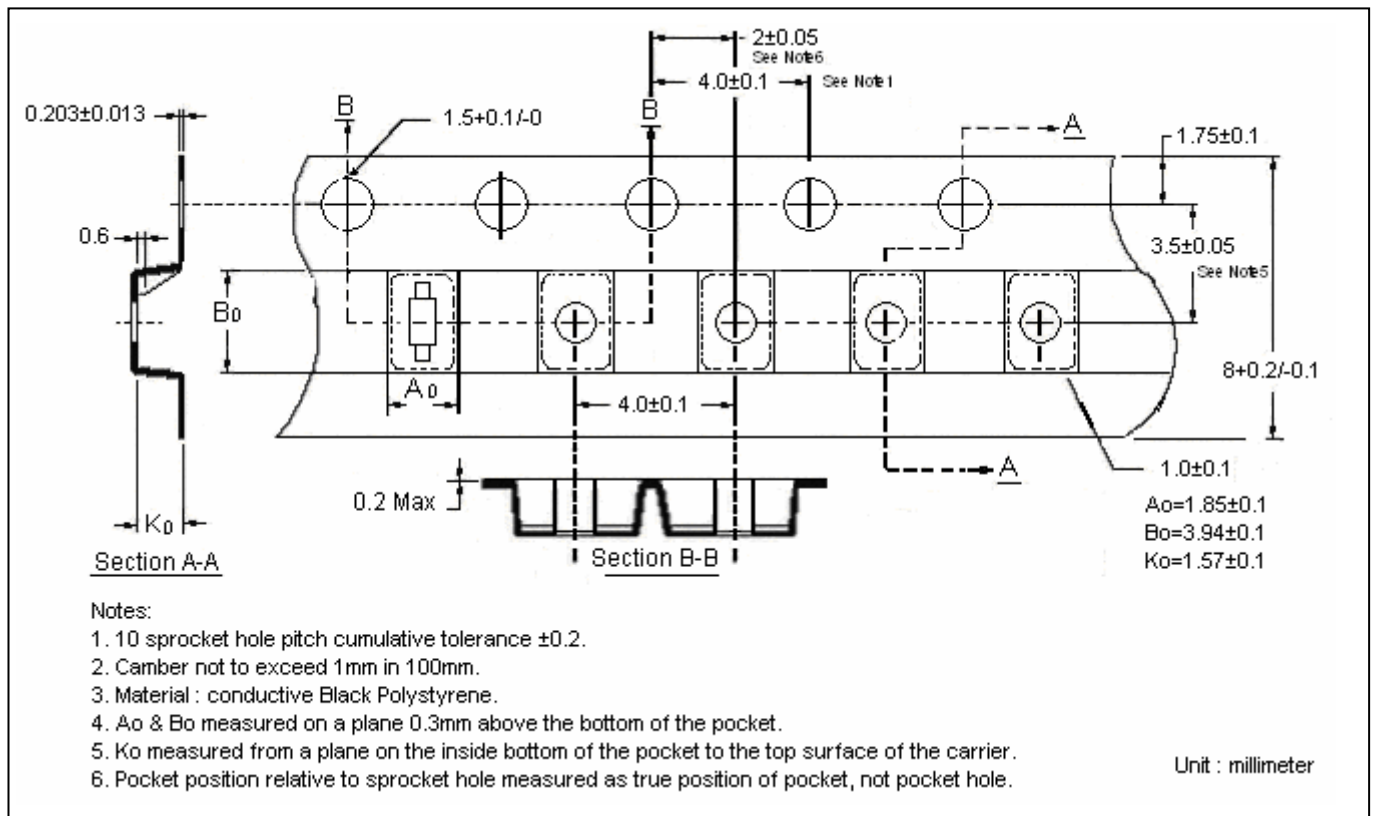

Recommended wave soldering condition

Product	Peak Temperature	Soldering Time
Pb-free devices	260 +0/-5 °C	5 +1/-1 seconds

Recommended temperature profile for IR reflow

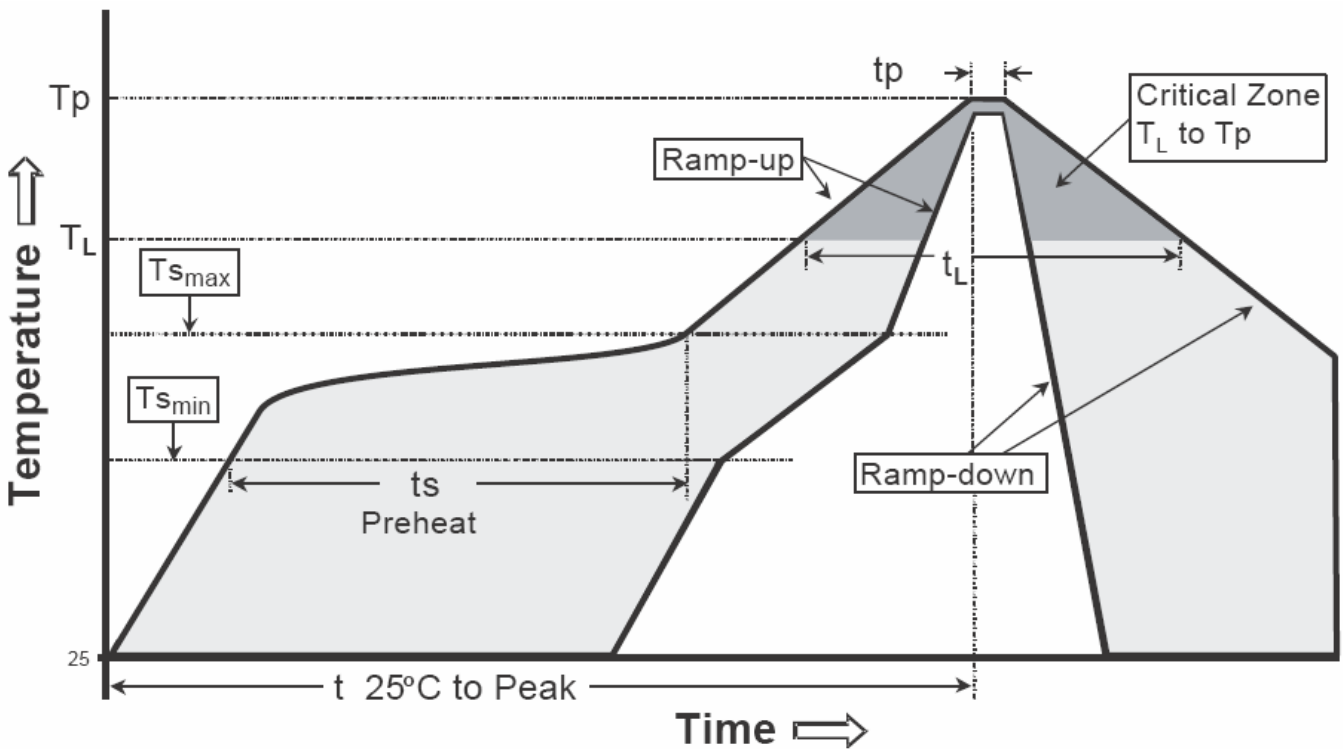

Profile feature	Sn-Pb eutectic Assembly	Pb-free Assembly
Average ramp-up rate (T _{smax} to T _p)	3°C/second max.	3°C/second max.
Preheat		
-Temperature Min(T _{s min})	100°C	150°C
-Temperature Max(T _{s max})	150°C	200°C
-Time(t _{s min} to t _{s max})	60-120 seconds	60-180 seconds
Time maintained above:		
-Temperature (T _L)	183°C	217°C
- Time (t _L)	60-150 seconds	60-150 seconds
Peak Temperature(T _p)	240 +0/-5 °C	260 +0/-5 °C
Time within 5°C of actual peak temperature(tp)	10-30 seconds	20-40 seconds
Ramp down rate	6°C/second max.	6°C/second max.
Time 25 °C to peak temperature	6 minutes max.	8 minutes max.

Note : All temperatures refer to topside of the package, measured on the package body surface.

SOD-123 Dimension

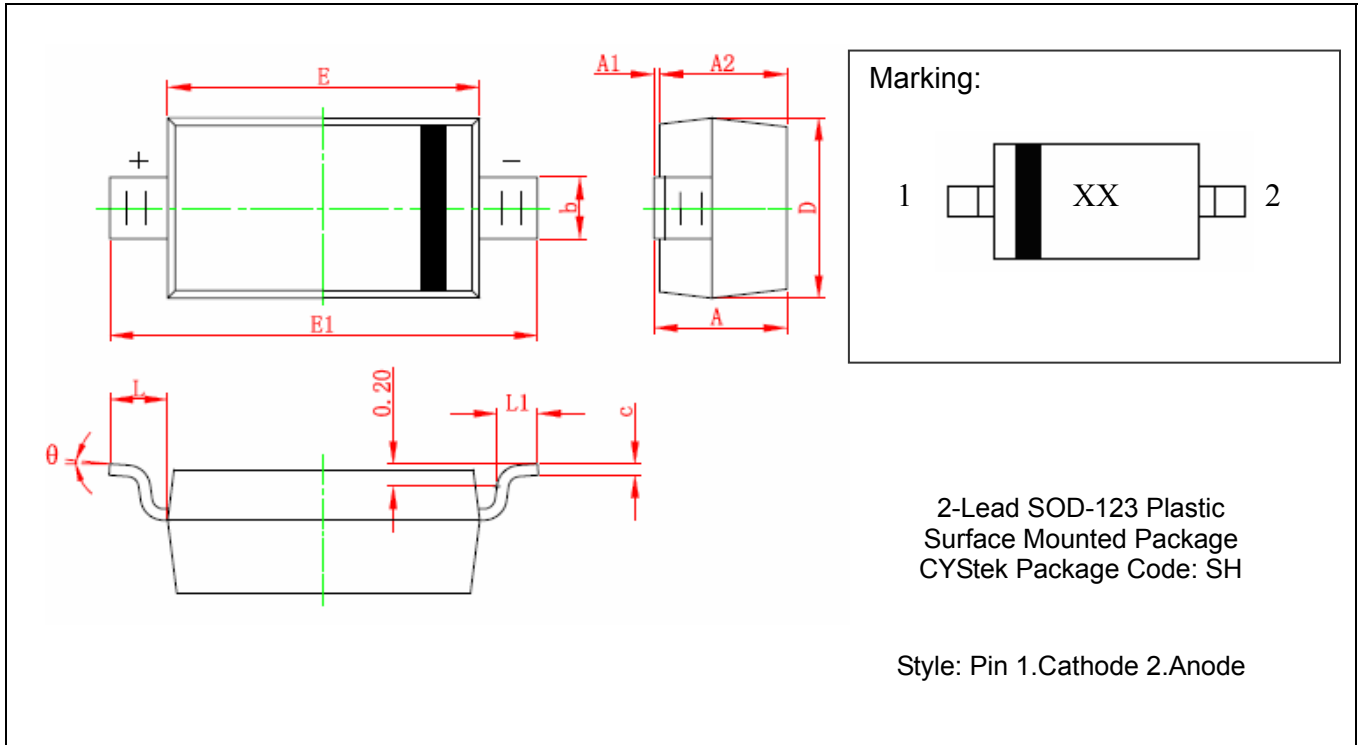

DIM	Millimeters		Inches		DIM	Millimeters		Inches	
	Min.	Max.	Min.	Max.		Min.	Max.	Min.	Max.
A	1.050	1.250	0.041	0.049	E	2.600	2.800	0.102	0.110
A1	0.000	0.100	0.000	0.004	E1	3.550	3.850	0.140	0.152
A2	1.050	1.115	0.041	0.045	L	0.500 REF		0.020 REF	
b	0.450	0.650	0.018	0.026	L1	0.250	0.450	0.010	0.018
c	0.080	0.150	0.003	0.006	θ	0°	8°	0°	8°
D	1.500	1.700	0.059	0.067					

Notes: 1.Controlling dimension : millimeters.
 2.Lead thickness specified per L/F drawing with solder plating.
 3.If there is any question with packing specification or packing method, please contact your local CYStek sales office.

Material:

- Lead: Pure tin plated.
- Mold Compound: Epoxy resin family, flammability solid burning class: UL94V-0.

Important Notice:

- All rights are reserved. Reproduction in whole or in part is prohibited without the prior written approval of CYStek.
- CYStek reserves the right to make changes to its products without notice.
- CYStek **semiconductor products are not warranted to be suitable for use in Life-Support Applications, or systems.**
- CYStek assumes no liability for any consequence of customer product design, infringement of patents, or application assistance.