

**Adjustable Precision Shunt Regulators**

# TL431SKA3

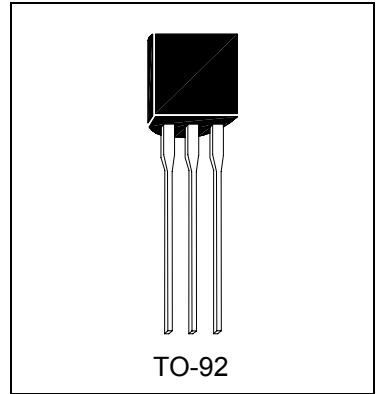

**Description**

The TL431SKA3 series are three-terminal adjustable regulators with guaranteed thermal stability over applicable temperature range. The output voltage may be set to any value between  $V_{REF}$  (approximately 2.495 volts) and 36 volts with two external resistors. These devices have a typical dynamic output impedance of  $0.1\Omega$ . Active output circuitry provides a very sharp turn-on characteristic, making these devices excellent replacement for zener diodes in many applications.

**Features**

- Programmable output voltage
- Temperature coefficient is 50ppm/°C typical
- Improved temperature compensation
- Sink current capability of 0.1mA to 100mA
- Low output noise voltage
- Fast turn on response
- Heat Resistance, Soldering iron : 300°C, 5 seconds
- Low dynamic output impedance  $0.1\Omega$  (typ.)
- Electrostatic discharge voltage 2.5kV.
- Pb-free lead plating and halogen-free package

**Classification**

Rank	A	B	C
$V_{REF}$	$2.495\pm 0.5\%$	$2.495\pm 1\%$	$2.495\pm 2\%$

**Ordering Information**

Device	Package	Shipping
TL431SKA3-X-TB-G	TO-92 (Pb-free lead plating and halogen-free package)	2000 pcs / Tape & Box
TL431SKA3-X-BK-G	TO-92 (Pb-free lead plating and halogen-free package)	1000 pcs/ bag, 10 bags/box, 10boxes/carton

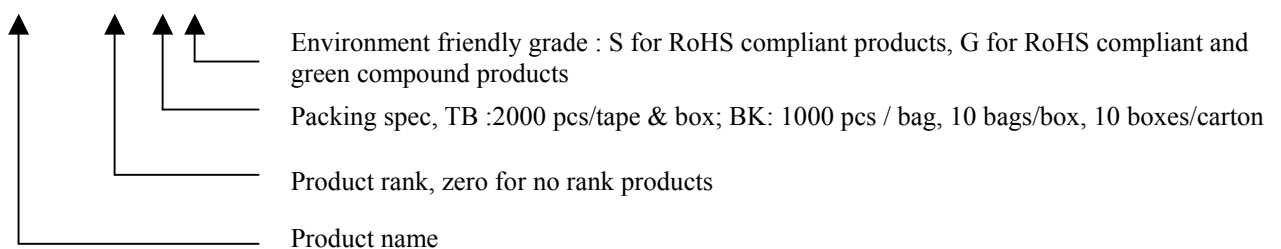

**Absolute Maximum Ratings** (Over operating free-air temperature range, unless otherwise specified)

Characteristics	Symbol	Value	Unit
Cathode Voltage	V <sub>KA</sub>	40	V
Cathode Current Range (Continuous)	I <sub>K</sub>	-100~+150	mA
Reference Input Current Range	I <sub>REF</sub>	-0.05~+10	mA
Power Dissipation	P <sub>D</sub>	T <sub>A</sub> =25 °C	0.6
		T <sub>C</sub> =25 °C	1.2
Operating Free-air Temperature Range	T <sub>j</sub>	-40~+125	°C
Lead Temperature (1.6mm aside from the case, 10s)	T <sub>L</sub>	260	°C
ESD(HBM)	V <sub>ESD</sub>	2500	V
Storage Temperature Range	T <sub>stg</sub>	-65~+150	°C

**Thermal Data**

Parameter	Symbol	Value	Unit
Thermal Resistance, Junction-to-ambient, max	R <sub>th,j-a</sub>	167	°C/W
Thermal Resistance, Junction-to-case, max	R <sub>th,j-c</sub>	83	

**Functional Block Diagram & Symbol**

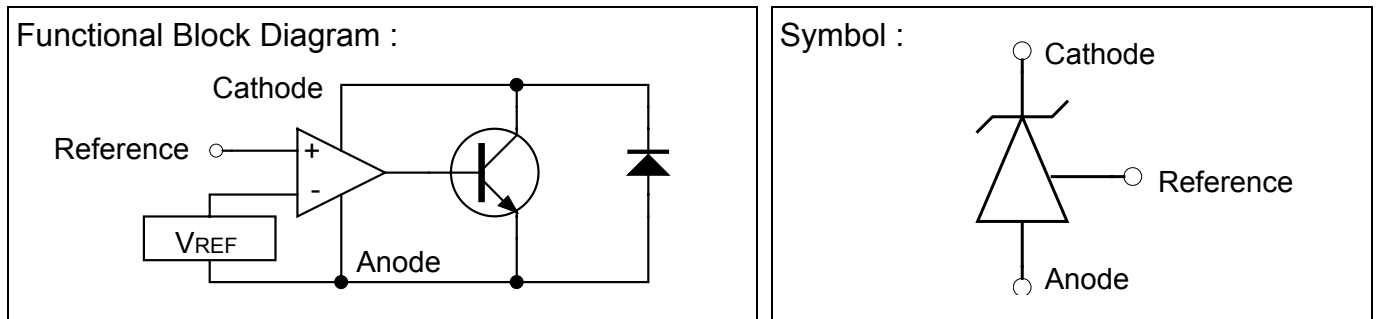

**Test Circuits**

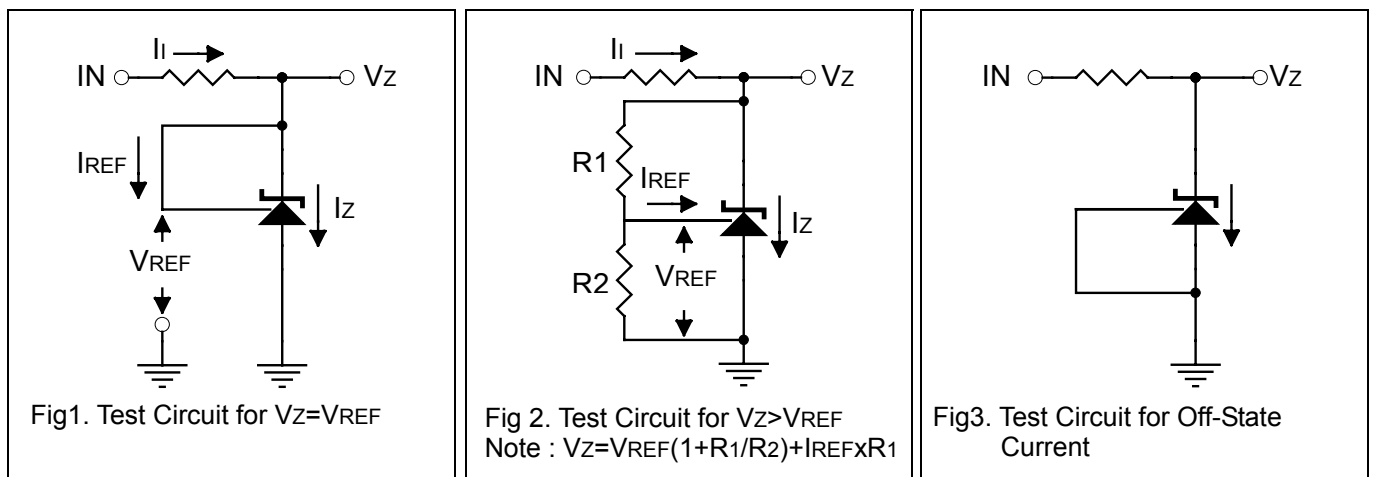



**Electrical Characteristics ( Ta=25°C unless otherwise specified )**

Characteristics	Symbol	Test Conditions	Min	Typ	Max	Unit	Test Circuit
Reference Input Voltage	A-rank	$V_{KA}=V_{REF}, I_K=10mA$	2.480	2.495	2.510	V	1
	B-rank		2.470	2.495	2.520		
	C-rank		2.445	2.495	2.545		
Deviation of Reference Input Voltage Over Full Temperature Range	$V_{REF(dev)}$	$V_{KA}=V_{REF}, I_K=10mA$ $0 \leq T_a \leq 125^\circ C$	-	8	17	mV	1
Ratio of Change in Reference Input Voltage to the Change in Cathode Voltage	$\Delta V_{REF} / \Delta V_{KA}$	$I_K=10mA,$ $\Delta V_{KA}=10V \text{ to } V_{REF}$	-	-1.0	-2.7	mV/V	2
		$I_K=10mA,$ $\Delta V_{KA}=36V \text{ to } 10V$	-	-0.4	-2.0	mV/V	2
Reference Input Current	$I_{REF}$	$I_K=10mA, R_1=10k\Omega,$ $R_2=\infty$	-	0.5	1.2	$\mu A$	2
Deviation of Reference Input Current Over Full Temperature Range	$I_{REF(dev)}$	$I_K=10mA, R_1=10k\Omega,$ $R_2=\infty, T_a=Full \text{ Range}$	-	0.4	1.2	$\mu A$	2
Minimum Cathode Current for Regulation	$I_{K(min)}$	$V_{KA}=V_{REF}$	-	0.04	0.3	mA	1
Off-State Cathode Current	$I_{K(off)}$	$V_{KA}=36V, V_{REF}=0V$	-	0.01	0.8	$\mu A$	3
Dynamic impedance	$Z_{KA}$	$V_{KA}=V_{REF}, f \leq 1.0KHz$ $I_K=0.2 \text{ to } 100mA$	-	0.1	0.37	$\Omega$	1

## Typical Characteristics

CATHODE CURRENT vs CATHODE VOLTAGE

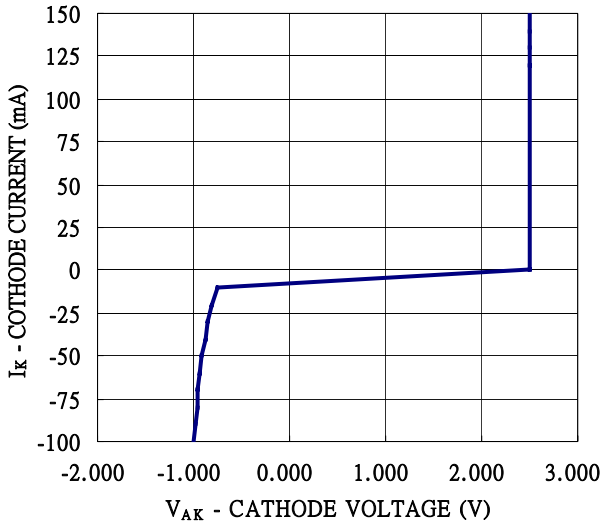

CATHODE CURRENT vs CATHODE VOLTAGE

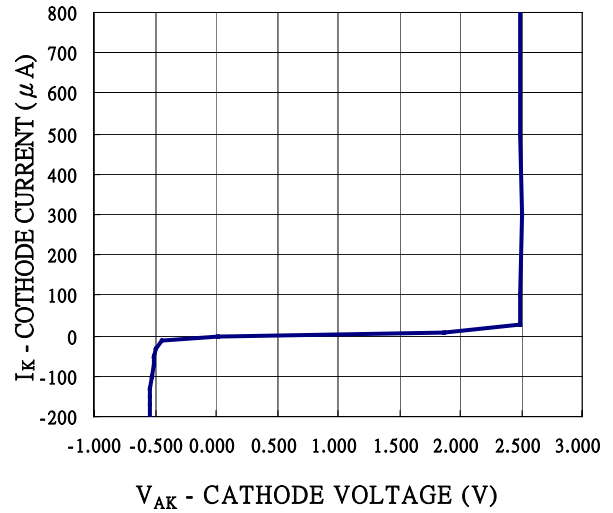

REFERENCE INPUT VOLTAGE vs AMBIENT TEMPERATURE

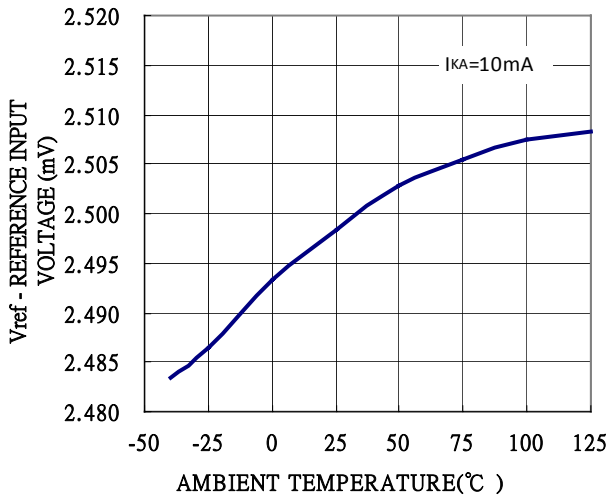

REFERENCE INPUT CURRENT vs AMBIENT TEMPERATURE

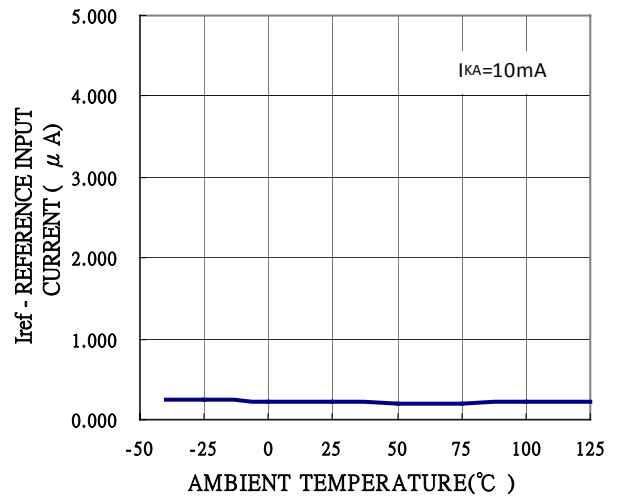

**Typical Characteristics(Cont.)**

CATHODE VOLTAGE vs REFERENCE INPUT VOLTAGE

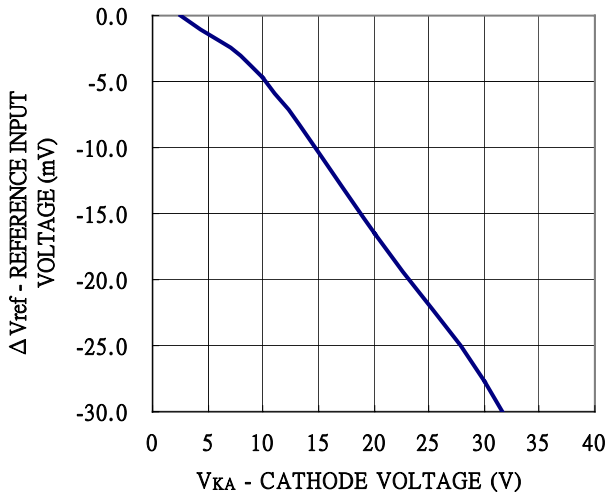

DYNAMIC IMPEDANCE vs FREQUENCY

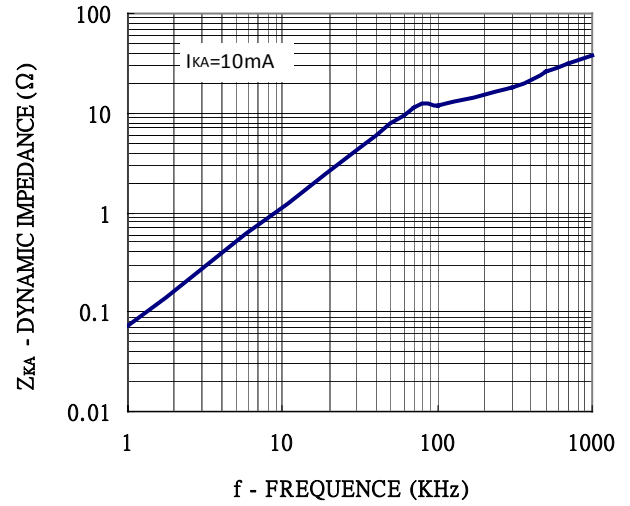

OPEN-LOOP VOLTAGE GAIN vs FREQUENCY

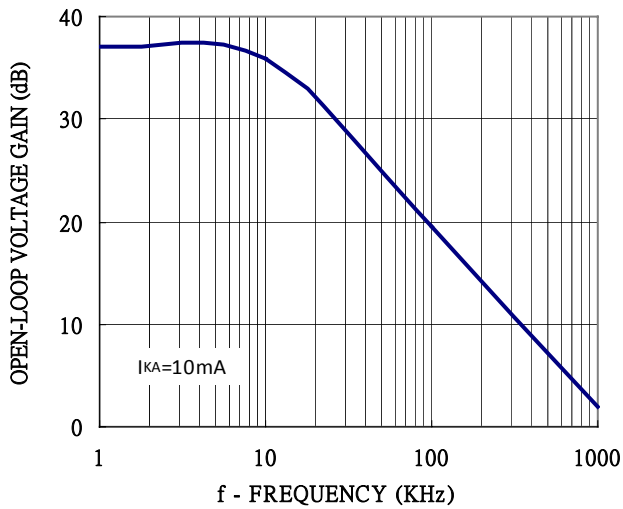

Power Derating Curve

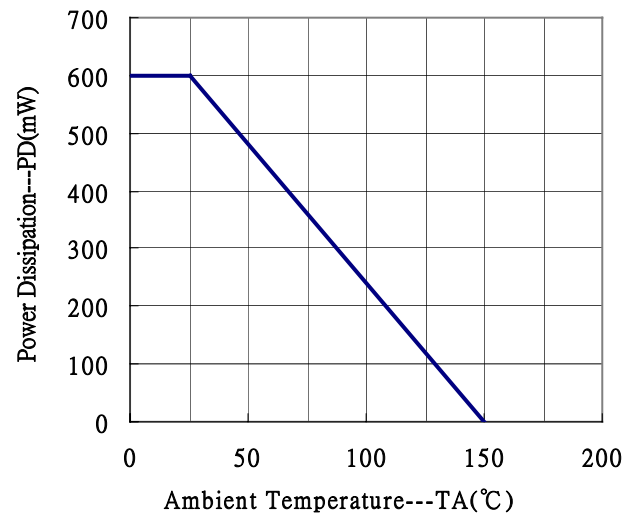

**Typical Characteristics(Cont.)**

Stability Boundary Conditions

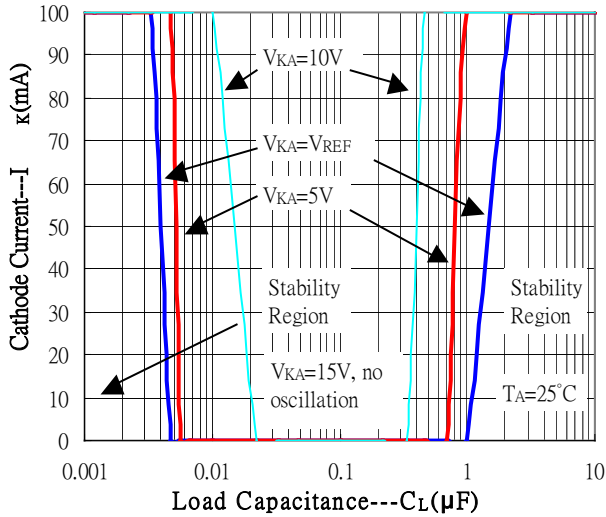

MINIMUM CATHODE CURRENT for REGULATION vs AMBIENT TEMPERATURE

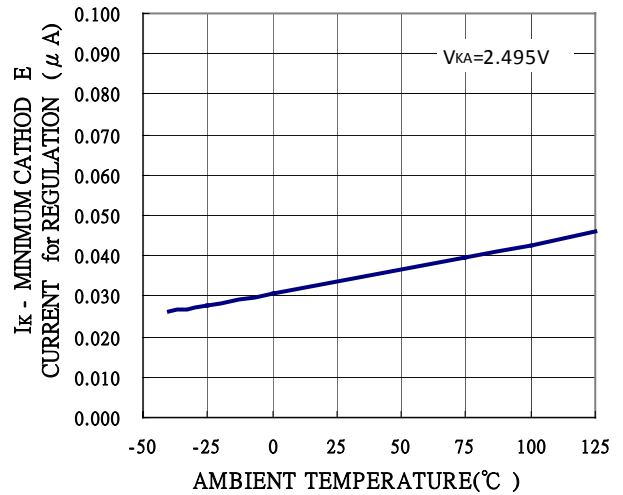

**Test Circuit for Stability Boundary Conditions**

$V_{KA}=V_{REF}$

$V_{KA}=5V, 10V, 15V$

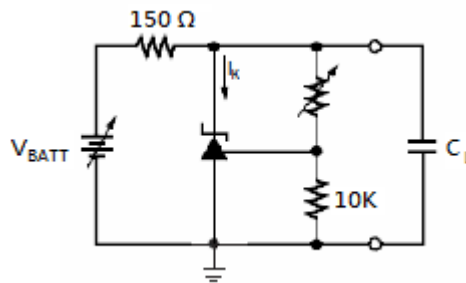
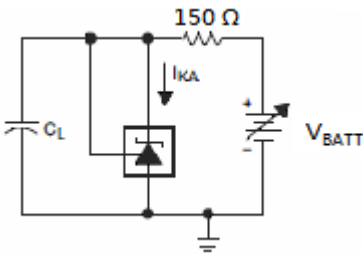

※  $C_L$ : MLCC capacitor

**TO-92 Taping Outline**

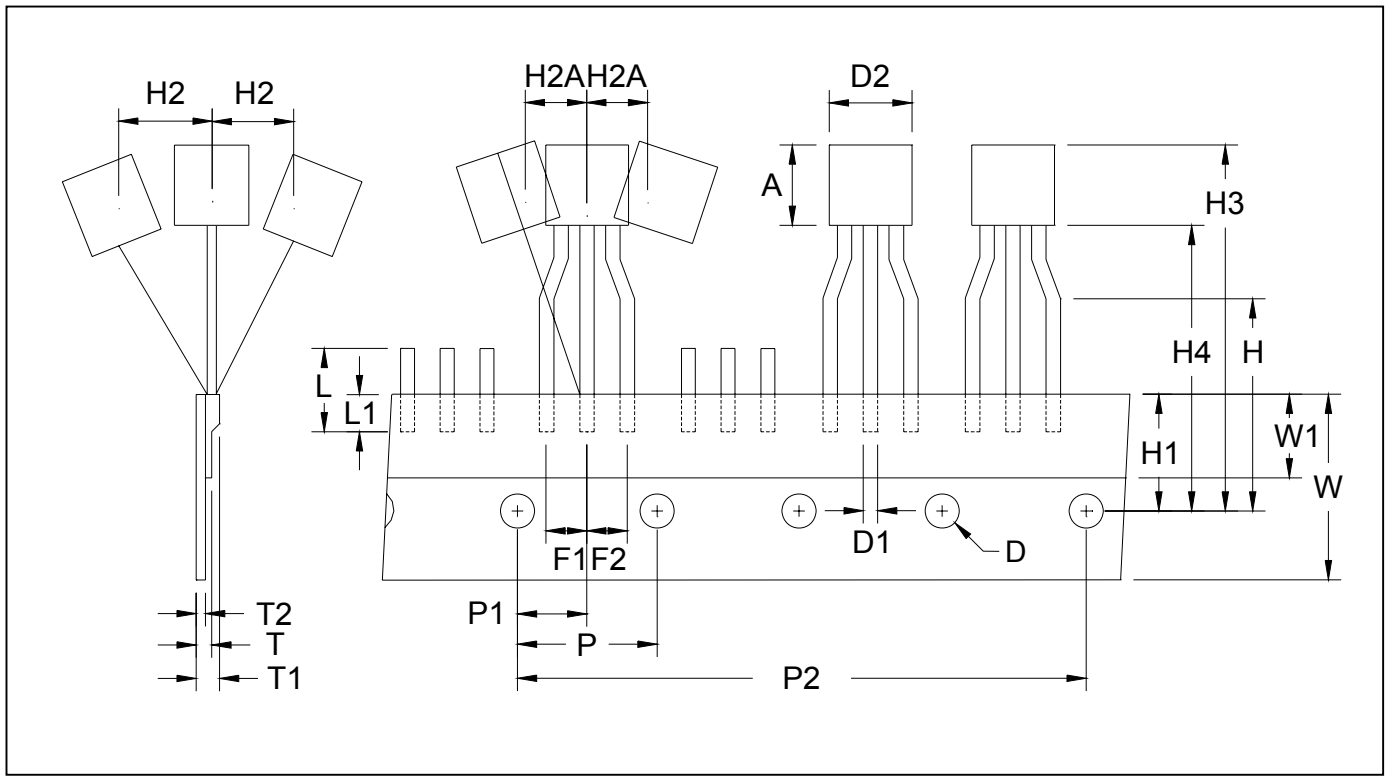

DIM	Item	Millimeters	
		Min.	Max.
A	Component body height	4.33	4.83
D	Tape Feed Diameter	3.80	4.20
D1	Lead Diameter	0.36	0.53
D2	Component Body Diameter	4.33	4.83
F1,F2	Component Lead Pitch	2.40	2.90
F1,F2	F1-F2	-	±0.3
H	Height Of Seating Plane	15.50	16.50
H1	Feed Hole Location	8.50	9.50
H2	Front To Rear Deflection	-	1
H2A	Deflection Left Or Right	-	1
H3	Component Height	-	27
H4	Feed Hole To Bottom Of Component	-	21
L	Lead Length After Component Removal	-	11
L1	Lead Wire Enclosure	2.50	-
P	Feed Hole Pitch	12.50	12.90
P1	Center Of Seating Plane Location	5.95	6.75
P2	4 Feed Hole Pitch	50.30	51.30
T	Over All Tape Thickness	-	0.55
T1	Total Taped Package Thickness	-	1.42
T2	Carrier Tape Thickness	0.36	0.68
W	Tape Width	17.50	19.00
W1	Adhesive Tape Width	5.00	7.00
-	20 pcs Pitch	253	255

**Recommended wave soldering condition**

Product	Peak Temperature	Soldering Time
Pb-free devices	260 +0/-5 °C	5 +1/-1 seconds

**Recommended temperature profile for IR reflow**

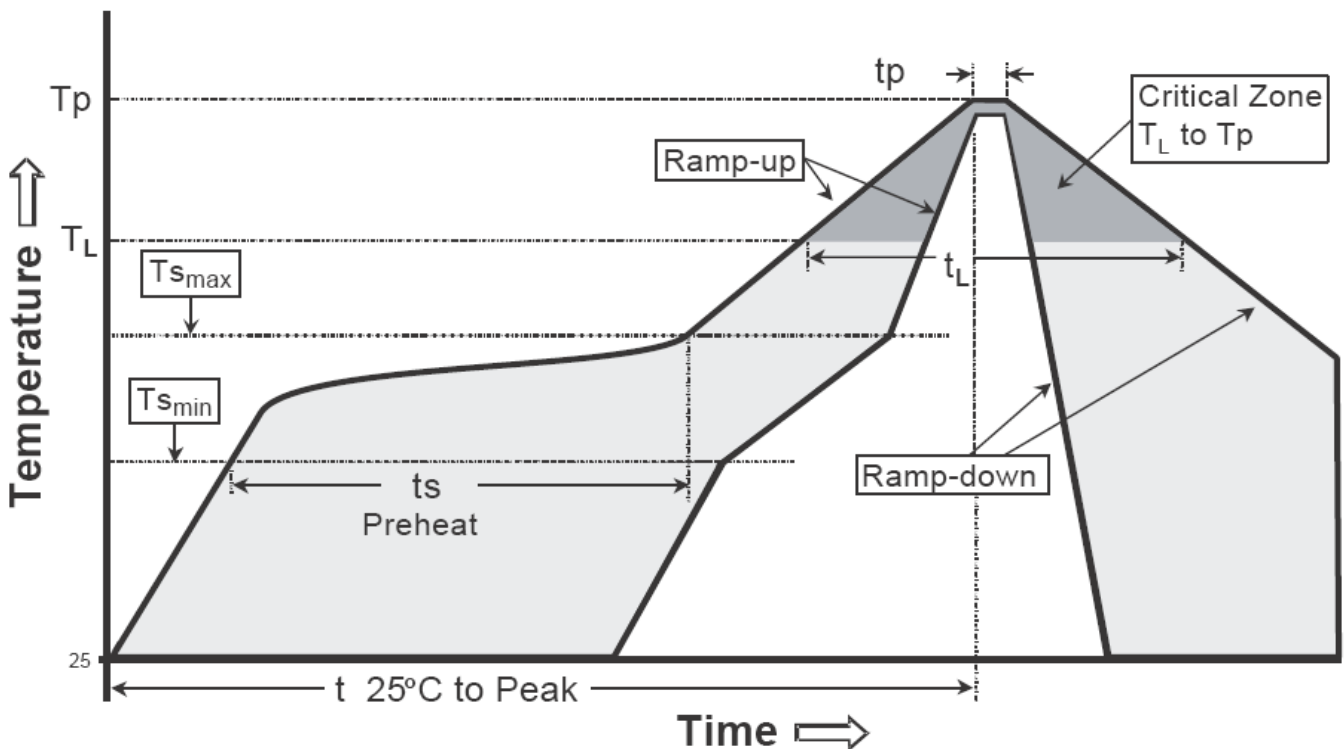

Profile feature	Sn-Pb eutectic Assembly	Pb-free Assembly
Average ramp-up rate (T <sub>s</sub> max to T <sub>p</sub> )	3°C/second max.	3°C/second max.
Preheat		
-Temperature Min(T <sub>s</sub> min)	100°C	150°C
-Temperature Max(T <sub>s</sub> max)	150°C	200°C
-Time(t <sub>s</sub> min to t <sub>s</sub> max)	60-120 seconds	60-180 seconds
Time maintained above:		
-Temperature (T <sub>L</sub> )	183°C	217°C
- Time (t <sub>L</sub> )	60-150 seconds	60-150 seconds
Peak Temperature(T <sub>P</sub> )	240 +0/-5 °C	260 +0/-5 °C
Time within 5°C of actual peak temperature(t <sub>p</sub> )	10-30 seconds	20-40 seconds
Ramp down rate	6°C/second max.	6°C/second max.
Time 25 °C to peak temperature	6 minutes max.	8 minutes max.

Note : All temperatures refer to topside of the package, measured on the package body surface.



**TO-92 Dimension**

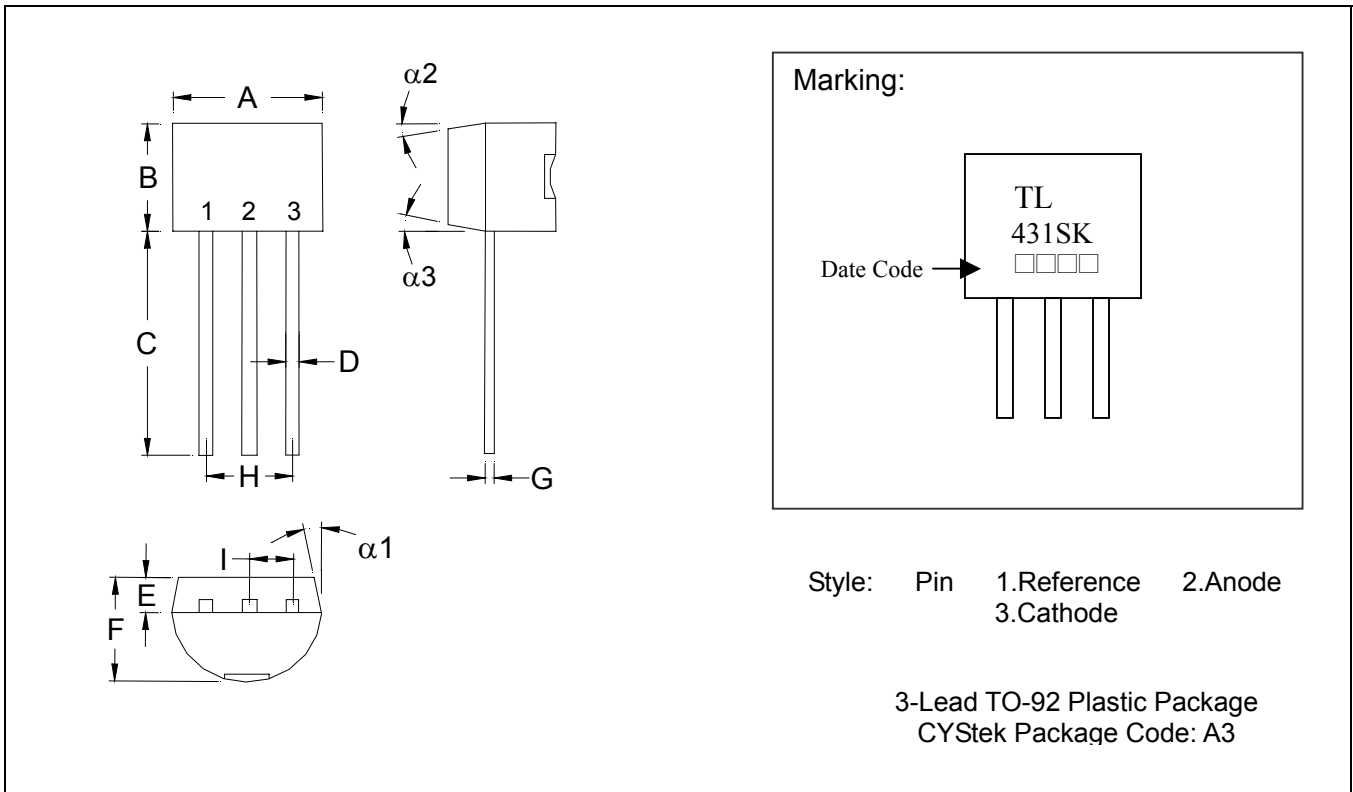

\*: Typical

DIM	Inches		Millimeters		DIM	Inches		Millimeters	
	Min.	Max.	Min.	Max.		Min.	Max.	Min.	Max.
A	0.1704	0.1902	4.33	4.83	G	0.0142	0.0220	0.36	0.56
B	0.1704	0.1902	4.33	4.83	H	-	*0.1000	-	*2.54
C	0.5000	-	12.70	-	I	-	*0.0500	-	*1.27
D	0.0142	0.0220	0.36	0.56	$\alpha 1$	-	*5°	-	*5°
E	-	*0.0500	-	*1.27	$\alpha 2$	-	*2°	-	*2°
F	0.1323	0.1480	3.36	3.76	$\alpha 3$	-	*2°	-	*2°

**Notes:** 1.Controlling dimension: millimeters.  
 2.Maximum lead thickness includes lead finish thickness, and minimum lead thickness is the minimum thickness of base material.  
 3.If there is any question with packing specification or packing method, please contact your local CYStek sales office.

**Material:**

- Lead: Pure tin plated.
- Mold Compound: Epoxy resin family, flammability solid burning class: UL94V-0.

**Important Notice:**

- All rights are reserved. Reproduction in whole or in part is prohibited without the prior written approval of CYStek.
- CYStek reserves the right to make changes to its products without notice.
- CYStek **semiconductor products are not warranted to be suitable for use in Life-Support Applications, or systems.**
- CYStek assumes no liability for any consequence of customer product design, infringement of patents, or application assistance.