

Surface Mount Transient Voltage Suppressors
Peak Pulse Power 600W Working Voltage 5.0 to 440V

SMBJ5.0 thru SMBJ440CA

Features

- Ideal for ESD protection of data line in accordance with IEC1000-4-2 (IEC801-2)
- Ideal for EFT protection of data line in accordance with IEC1000-4-4 (IEC801-4)
- Very-fast response time
- Excellent clamping capability
- Low leakage
- Glass passivated chip
- 600W peak pulse power capability with a 10/1000µs waveform, repetition rate (duty cycle) : 0.01%
- RoHS compliant package

Outline



Mechanical Data

- Case : JEDEC DO-214AA(SMB) molded plastic body
- Epoxy : Plastic package has UL flammability classification 94V-0
- Terminals: Pure tin plated, solderable per MIL-STD-750 method 2026
- Polarity: Color band denotes cathode end except Bipolar
- Mounting position : Any
- Weight: 0.093 gram approx.

Devices for bidirectional applications

For bi-directional devices, use suffix CA (e.g. SMBJ10CA). Electrical characteristics apply in both directions.

Ordering Information

Device	Package	Shipping
SMBJXXXA- 0-T6-G	SMB	3000 pcs / Tape & Reel
SMBJXXXCA-0-T6-G	(Pb-free lead plating and halogen-free package)	

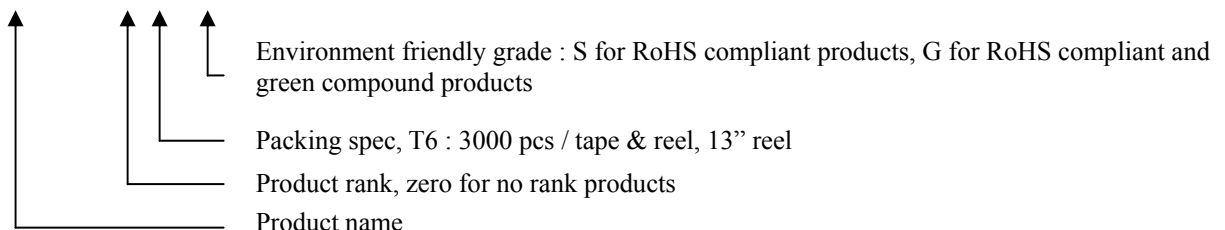

Maximum Ratings and Characteristics($T_A=25^\circ\text{C}$, unless otherwise noted)

Parameter	Symbol	Value	Unit
Peak power dissipation with a 10/1000 μs waveform	PPP	600 (Note 1)	W
Peak pulse current with a 10/1000 μs waveform	IPP	See next table (Note 1)	A
Peak forward surge current, 8.3ms single half sine wave unidirectional only (Note 2)	IFSM	100	A
Maximum instantaneous forward voltage at 50A for unidirectional only (Note 3)	V _F	3.5/5.0	V
Power dissipation on infinite heatsink at $T_L=75^\circ\text{C}$	P _D	5	W
Operating junction and storage temperature range	T _J ;T _{STG}	-55 ~ +150	$^\circ\text{C}$

Notes: 1.Non-repetitive current pulse, per Fig. 5 and derated above $T_A=25^\circ\text{C}$ per Fig. 1.

2.Measured on 8.3ms single half sine-wave or equivalent square wave, duty cycle=4 pulses per minute maximum.

3. $V_F<3.5\text{V}$ for devices of $V_{BR}<200\text{V}$ and $V_F<5\text{V}$ for devices of $V_{BR}>201\text{V}$.

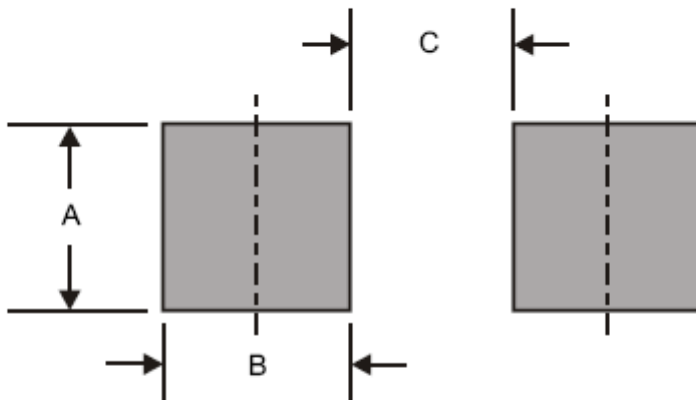
Recommended Footprint

Dimensions in inches and (millimeters)

DIM	Inches	Millimeters
	Typ	Typ
A	0.142	3.60
B	0.059	1.50
C	0.118	3.00



Electrical Characteristics Ratings at 25°C ambient temperature, unless otherwise noted.

Part Number (UNI)	Part Number (BI)	Device Marking Code		Breakdown Voltage $V_{(BR)}$ @ I_T			Maximum reverse leakage I_R @ V_{RWM} (μA)	Working Peak reverse voltage V_{RWM} (V)	Maximum reverse surge Current I_{PP} (A)	Maximum clamping voltage V_C @ I_{PP} (V)
		UNI	BI	Min (V)	Max (V)	I_T (mA)				
SMBJ5.0	SMBJ5.0C	KD	AD	6.40	7.30	10	800	5.0	62.50	9.6
SMBJ5.0A	SMBJ5.0CA	KE	AE	6.40	7.00	10	800	5.0	65.22	9.2
SMBJ6.0	SMBJ6.0C	KF	AF	6.67	8.15	10	800	6.0	52.63	11.4
SMBJ6.0A	SMBJ6.0CA	KG	AG	6.67	7.37	10	800	6.0	58.25	10.3
SMBJ6.5	SMBJ6.5C	KH	AH	7.22	8.82	10	500	6.5	48.78	12.3
SMBJ6.5A	SMBJ6.5CA	KK	AK	7.22	7.98	10	500	6.5	53.57	11.2
SMBJ7.0	SMBJ7.0C	KL	AL	7.78	9.51	10	200	7.0	45.11	13.3
SMBJ7.0A	SMBJ7.0CA	KM	AM	7.78	8.60	10	200	7.0	50.00	12.0
SMBJ7.5	SMBJ7.5C	KN	AN	8.33	10.20	1	100	7.5	41.96	14.3
SMBJ7.5A	SMBJ7.5CA	KP	AP	8.33	9.21	1	100	7.5	46.51	12.9
SMBJ8.0	SMBJ8.0C	KQ	AQ	8.89	10.90	1	50	8.0	40.00	15.0
SMBJ8.0A	SMBJ8.0CA	KR	AR	8.89	9.83	1	50	8.0	44.12	13.6
SMBJ8.5	SMBJ8.5C	KS	AS	9.44	11.50	1	10	8.5	37.74	15.9
SMBJ8.5A	SMBJ8.5K	KT	AT	9.44	10.40	1	10	8.5	41.67	14.4
SMBJ9.0	SMBJ9.0C	KU	AU	10.00	12.20	1	5	9.0	35.50	16.9
SMBJ9.0A	SMBJ9.0CA	KV	AV	10.00	11.10	1	5	9.0	38.96	15.4
SMBJ10	SMBJ10C	KW	AW	11.10	13.60	1	5	10.0	31.91	18.8
SMBJ10A	SMBJ10CA	KX	AX	11.10	12.30	1	5	10.0	35.29	17.0
SMBJ11	SMBJ11C	KY	AY	12.20	14.90	1	5	11.0	29.85	20.1
SMBJ11A	SMBJ11CA	KZ	AZ	12.20	13.50	1	5	11.0	32.97	18.2
SMBJ12	SMBJ12C	LD	BD	13.30	16.30	1	5	12.0	27.27	22.0
SMBJ12A	SMBJ12CA	LE	BE	13.30	14.70	1	5	12.0	30.15	19.9
SMBJ13	SMBJ13C	LF	BF	14.40	17.60	1	5	13.0	25.21	23.8
SMBJ13A	SMBJ13CA	LG	BG	14.40	15.90	1	5	13.0	27.91	21.5
SMBJ14	SMBJ14C	LH	BH	15.60	19.10	1	5	14.0	23.26	25.8
SMBJ14A	SMBJ14CA	LK	BK	15.60	17.20	1	5	14.0	25.86	23.2
SMBJ15	SMBJ15C	LL	BL	16.70	20.40	1	5	15.0	22.30	26.9
SMBJ15A	SMBJ15CA	LM	BM	16.70	18.50	1	5	15.0	24.59	24.4
SMBJ16	SMBJ16C	LN	BN	17.80	21.80	1	5	16.0	20.83	28.8
SMBJ16A	SMBJ16CA	LP	BP	17.80	19.70	1	5	16.0	23.08	26.0
SMBJ17	SMBJ17C	LQ	BQ	18.90	23.10	1	5	17.0	19.67	30.5
SMBJ17A	SMBJ17CA	LR	BR	18.90	20.90	1	5	17.0	21.74	27.6
SMBJ18	SMBJ18C	LS	BS	20.00	24.40	1	5	18.0	18.63	32.2
SMBJ18A	SMBJ18CA	LT	BT	20.00	22.10	1	5	18.0	20.55	29.2
SMBJ19	SMBJ19C	LA	BA	21.13	25.76	1	5	19.0	17.64	34.0
SMBJ19A	SMBJ19CA	LB	BB	21.10	23.30	1	5	19.0	19.49	30.8
SMBJ20	SMBJ20C	LU	BU	22.20	27.10	1	5	20.0	16.76	35.8
SMBJ20A	SMBJ20CA	LV	BV	22.20	24.50	1	5	20.0	18.52	32.4
SMBJ22	SMBJ22C	LW	BW	24.40	29.80	1	5	22.0	15.23	39.4



Electrical Characteristics(Cont.)

Part Number (UNI)	Part Number (BI)	Device Marking Code		Breakdown Voltage $V_{(BR)} @ I_T$			Maximum reverse leakage $I_R @ V_{RWM}$ (μA)	Working Peak reverse voltage V_{RWM} (V)	Maximum reverse surge Current I_{PP} (A)	Maximum clamping voltage $V_C @ I_{PP}$ (V)
		UNI	BI	Min (V)	Max (V)	I_T (mA)				
SMBJ22A	SMBJ22CA	LX	BX	24.40	26.90	1	5	22.0	16.9	35.5
SMBJ24	SMBJ24C	LY	BY	26.70	32.60	1	5	24.0	13.95	43.0
SMBJ24A	SMBJ24CA	LZ	BZ	26.70	29.50	1	5	24.0	15.42	38.9
SMBJ26	SMBJ26C	MD	CD	28.90	35.30	1	5	26.0	12.88	46.6
SMBJ26A	SMBJ26CA	ME	CE	28.90	31.90	1	5	26.0	14.25	42.1
SMBJ28	SMBJ28C	MF	CF	31.10	38.00	1	5	28.0	12.00	50.0
SMBJ28A	SMBJ28CA	MG	CG	31.10	34.40	1	5	28.0	13.22	45.4
SMBJ30	SMBJ30C	MH	CH	33.30	40.70	1	5	30.0	11.21	53.5
SMBJ30A	SMBJ30CA	MK	CK	33.30	36.80	1	5	30.0	12.40	48.4
SMBJ33	SMBJ33C	ML	CL	36.70	44.90	1	5	33.0	10.17	59.0
SMBJ33A	SMBJ33CA	MM	CM	36.70	40.60	1	5	33.0	11.26	53.3
SMBJ36	SMBJ36C	MN	CN	40.00	48.90	1	5	36.0	9.33	64.3
SMBJ36A	SMBJ36CA	MP	CP	40.00	44.20	1	5	36.0	10.33	58.1
SMBJ40	SMBJ40C	MQ	CQ	44.40	54.30	1	5	40.0	8.40	71.4
SMBJ40A	SMBJ40CA	MR	CR	44.40	49.10	1	5	40.0	9.30	64.5
SMBJ43	SMBJ43C	MS	CS	47.80	58.40	1	5	43.0	7.82	76.7
SMBJ43A	SMBJ43CA	MT	CT	47.80	52.80	1	5	43.0	8.65	69.4
SMBJ45	SMBJ45C	MU	CU	50.00	61.10	1	5	45.0	7.47	80.3
SMBJ45A	SMBJ45CA	MV	CV	50.00	55.30	1	5	45.0	8.25	72.7
SMBJ48	SMBJ48C	MW	CW	53.30	65.10	1	5	48.0	7.02	85.5
SMBJ48A	SMBJ48CA	MX	CX	53.30	58.90	1	5	48.0	7.75	77.4
SMBJ51	SMBJ51C	MY	CY	56.70	69.30	1	5	51.0	6.59	91.1
SMBJ51A	SMBJ51CA	MZ	CZ	56.70	62.70	1	5	51.0	7.28	82.4
SMBJ54	SMBJ54C	ND	DD	60.00	73.30	1	5	54.0	6.23	96.3
SMBJ54A	SMBJ54CA	NE	DE	60.00	66.30	1	5	54.0	6.89	87.1
SMBJ58	SMBJ58C	NF	DF	64.40	78.70	1	5	58.0	5.83	103.0
SMBJ58A	SMBJ58CA	NG	DG	64.40	71.20	1	5	58.0	6.41	93.6
SMBJ60	SMBJ60C	NH	DH	66.70	81.50	1	5	60.0	5.61	107.0
SMBJ60A	SMBJ60CA	NK	DK	66.70	73.70	1	5	60.0	6.20	96.8
SMBJ64	SMBJ64C	NL	DL	71.10	86.90	1	5	64.0	5.26	114.0
SMBJ64A	SMBJ64CA	NM	DM	71.10	78.60	1	5	64.0	5.83	103.0
SMBJ70	SMBJ70C	NN	DN	77.80	95.10	1	5	70.0	4.80	125.0
SMBJ70A	SMBJ70CA	NP	DP	77.80	86.00	1	5	70.0	5.31	113.0
SMBJ75	SMBJ75C	NQ	DQ	83.30	102.00	1	5	75.0	4.48	134.0
SMBJ75A	SMBJ75CA	NR	DR	83.30	92.10	1	5	75.0	4.96	121.0
SMBJ78	SMBJ78C	NS	DS	86.70	106.00	1	5	78.0	4.32	139.0
SMBJ78A	SMBJ78CA	NT	DT	86.70	95.80	1	5	78.0	4.76	126.0
SMBJ80	SMBJ80C	NA	DA	88.96	108.80	1	5	80.0	4.19	143.2
SMBJ80A	SMBJ80CA	NB	DB	88.80	97.60	1	5	80.0	4.63	129.6



Electrical Characteristics(Cont.)

Part Number (UNI)	Part Number (BI)	Device Marking Code		Breakdown Voltage $V_{(BR)} @ I_T$			Maximum reverse leakage I_R @ V_{RWM} (μA)	Working Peak reverse voltage V_{RWM} (V)	Maximum reverse surge Current I_{PP} (A)	Maximum clamping voltage V_C @ I_{PP} (V)
		UNI	BI	Min (V)	Max (V)	I_T (mA)				
SMBJ85	SMBJ85C	NU	DU	94.40	115.00	1	5	85.0	3.97	151.0
SMBJ85A	SMBJ85CA	NV	DV	94.40	104.00	1	5	85.0	4.38	137.0
SMBJ90	SMBJ90C	NW	DW	100.00	122.00	1	5	90.0	3.75	160.0
SMBJ90A	SMBJ90CA	NX	DX	100.00	111.00	1	5	90.0	4.11	146.0
SMBJ100	SMBJ100C	NY	DY	111.00	136.00	1	5	100.0	3.35	179.0
SMBJ100A	SMBJ100CA	NZ	DZ	111.00	123.00	1	5	100.0	3.70	162.0
SMBJ110	SMBJ110C	PD	ED	122.00	149.00	1	5	110.0	3.06	196.0
SMBJ110A	SMBJ110CA	PE	EE	122.00	135.00	1	5	110.0	3.39	177.0
SMBJ120	SMBJ120C	PF	EF	133.00	163.00	1	5	120.0	2.80	214.0
SMBJ120A	SMBJ120CA	PG	EG	133.00	147.00	1	5	120.0	3.11	193.0
SMBJ130	SMBJ130C	PH	EH	144.00	176.00	1	5	130.0	2.60	231.0
SMBJ130A	SMBJ130CA	PK	EK	144.00	159.00	1	5	130.0	2.87	209.0
SMBJ140	SMBJ140C	PA	EA	155.68	190.40	1	5	140.0	2.39	250.6
SMBJ140A	SMBJ140CA	PB	EB	155.00	171.00	1	5	140.0	2.65	226.8
SMBJ150	SMBJ150C	PL	EL	167.00	204.00	1	5	150.0	2.24	268.0
SMBJ150A	SMBJ150CA	PM	EM	167.00	185.00	1	5	150.0	2.47	243.0
SMBJ160	SMBJ160C	PN	EN	178.00	218.00	1	5	160.0	2.09	287.0
SMBJ160A	SMBJ160CA	PP	EP	178.00	197.00	1	5	160.0	2.32	259.0
SMBJ170	SMBJ170C	PQ	EQ	189.00	231.00	1	5	170.0	1.97	304.0
SMBJ170A	SMBJ170CA	PR	ER	189.00	209.00	1	5	170.0	2.18	275.0
SMBJ180	SMBJ180C	PS	ES	200.16	244.80	1	5	180.0	1.86	322.2
SMBJ180A	SMBJ180CA	PT	ET	200.00	220.00	1	5	180.0	2.06	291.6
SMBJ190	SMBJ190C	PU	EU	211.28	258.40	1	5	190.0	1.76	340.1
SMBJ190A	SMBJ190CA	PV	EV	211.00	232.00	1	5	190.0	1.95	307.8
SMBJ200A	SMBJ200CA	PW	EW	224.00	247.00	1	5	200.0	1.85	324.0
SMBJ220A	SMBJ220CA	PX	EX	246.00	272.00	1	5	220.0	1.69	356.0
SMBJ250A	SMBJ250CA	PZ	EZ	279.00	309.00	1	5	250.0	1.48	405.0
SMBJ300A	SMBJ300CA	QE	FE	335.00	371.00	1	5	300.0	1.23	486.0
SMBJ350A	SMBJ350CA	QG	FG	391.00	432.00	1	5	350.0	1.06	567.0
SMBJ400A	SMBJ400CA	QK	FK	447.00	494.00	1	5	400.0	0.93	648.0
SMBJ440A	SMBJ440CA	QM	FM	492.00	543.00	1	5	440.0	0.84	713.0

Note: 1. Suffix 'A' denotes 5% tolerance device. Without 'A' denotes 10% tolerance device.
 2. Add suffix 'C' or 'CA' after part number to specify Bi-directional devices.
 3. For bidirectional types having V_R of 10 volts and less, the I_R limit is doubled.

Typical Characteristics

Ratings and Characteristics Curves ($T_A=25^\circ\text{C}$ unless otherwise noted)

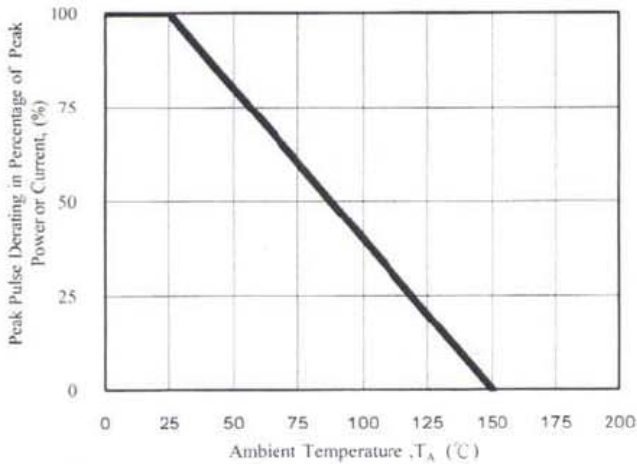

Fig. 1 - Pulse Derating Curve

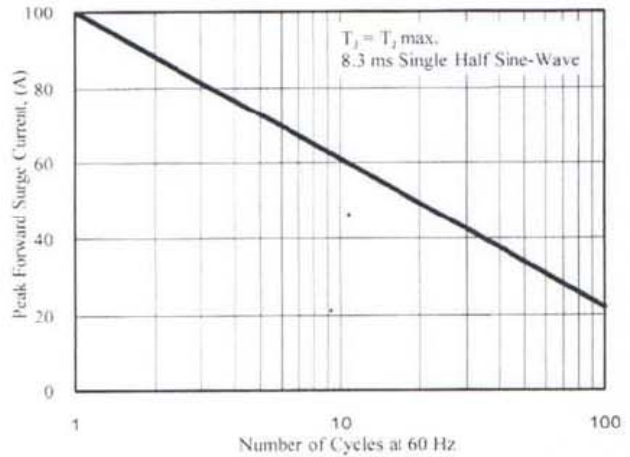

Fig. 2 - Maximum Non-Repetitive Surge Current

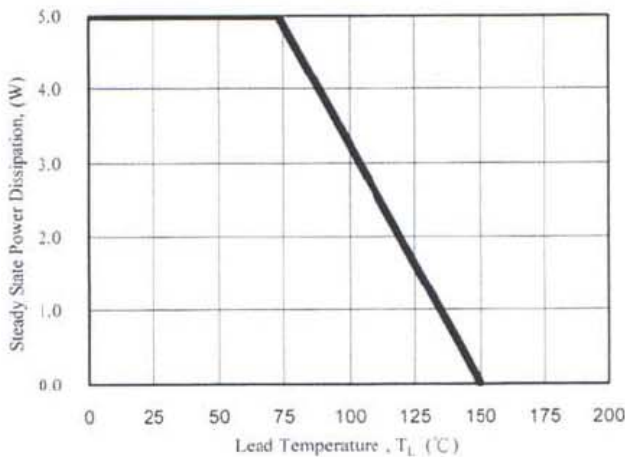

Fig. 3 - Steady State Power Derating Curve

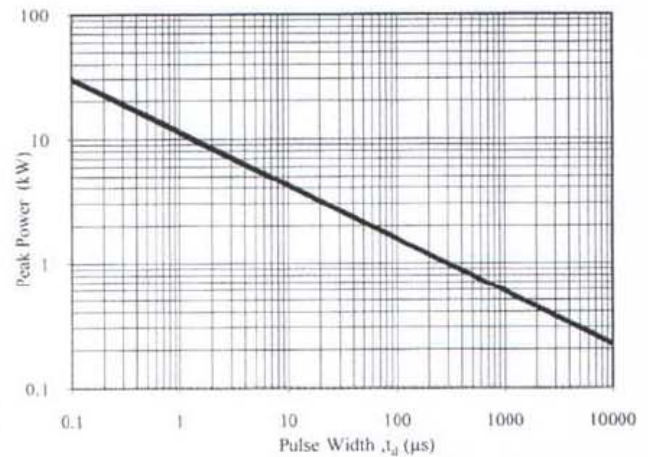

Fig. 4 - Peak Pulse Power Rating Curve

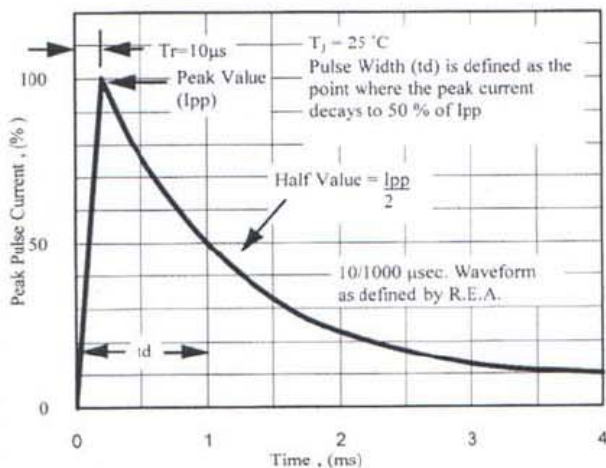

Fig. 5 - Pulse Waveform

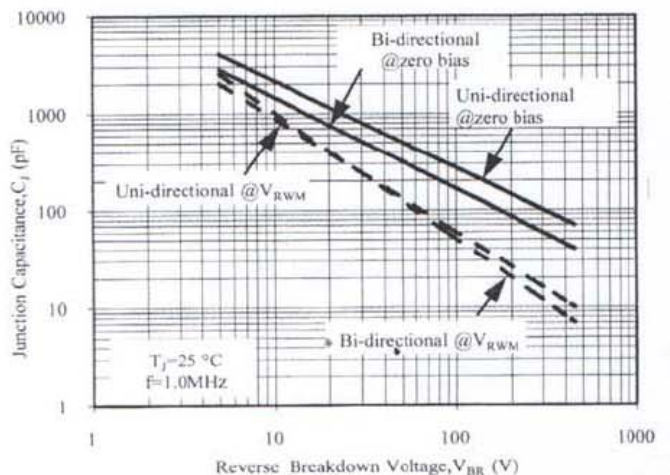
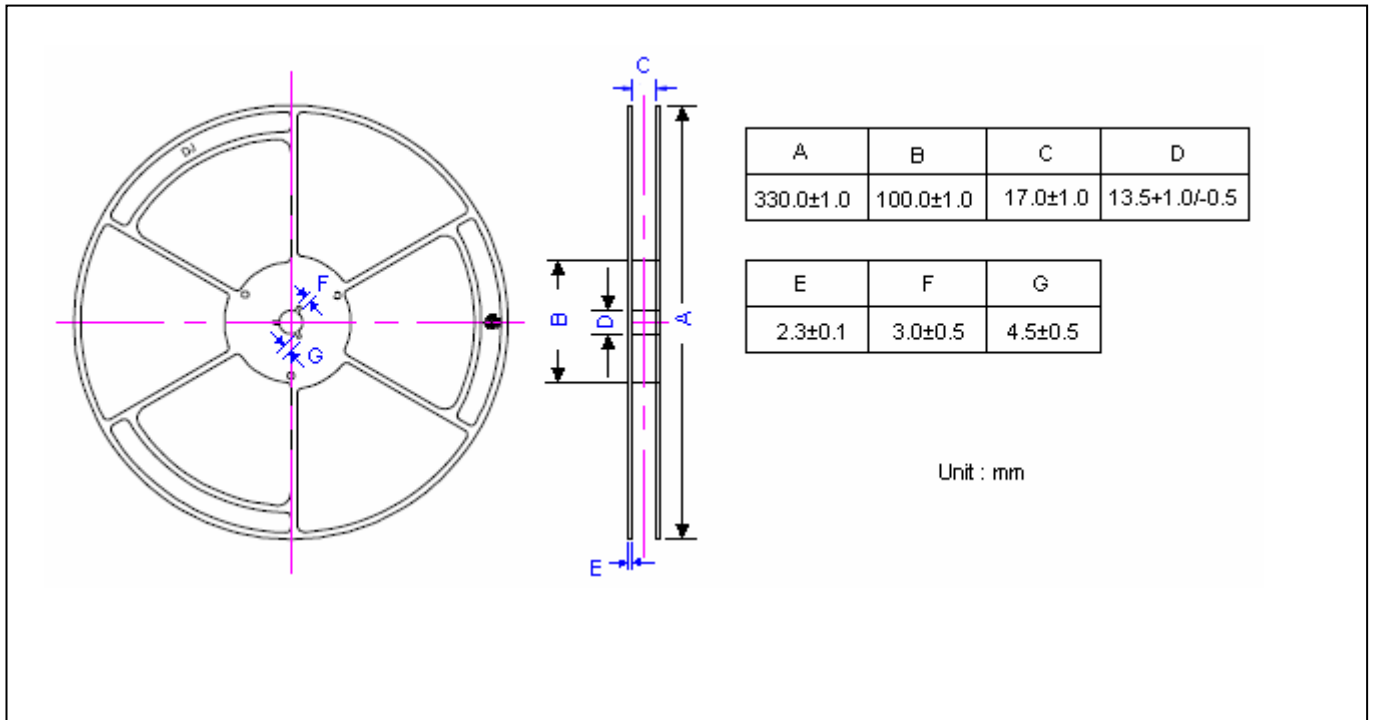
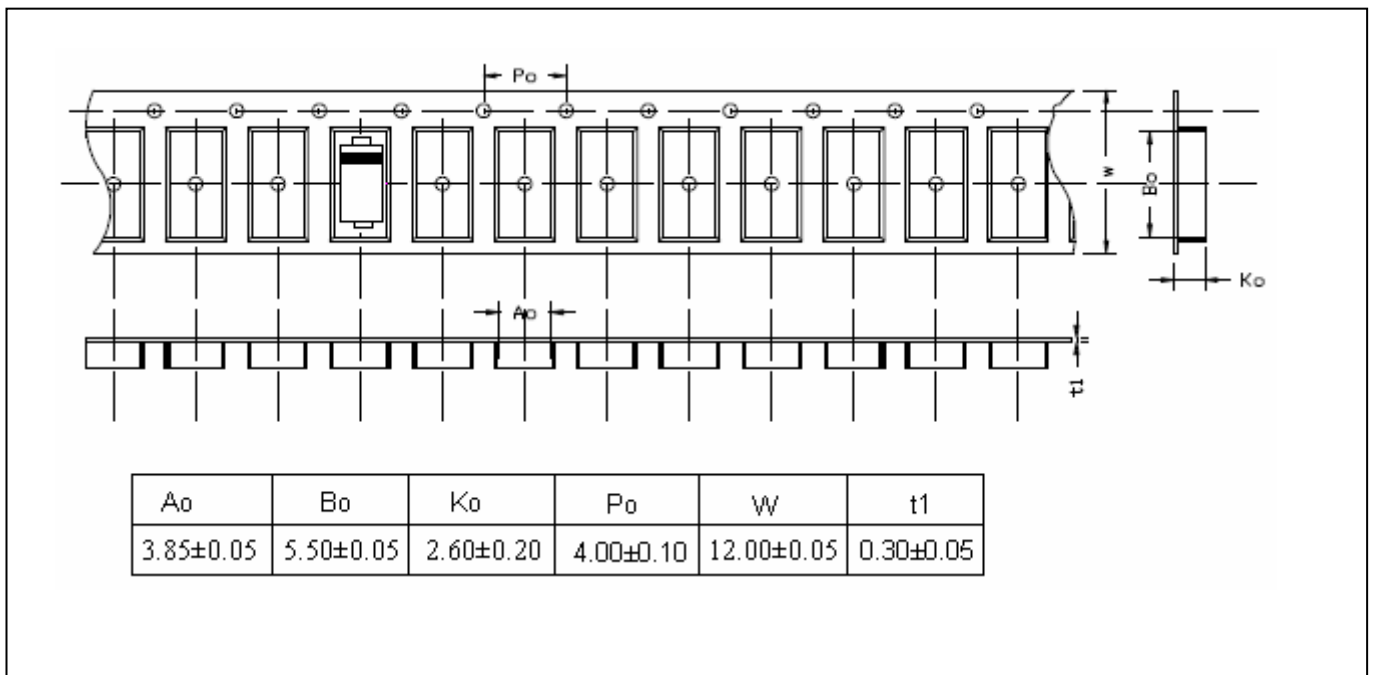

Fig. 6 - Typical Junction Capacitance

Reel Dimension



Carrier Tape Dimension



Recommended wave soldering condition

Product	Peak Temperature	Soldering Time
Pb-free devices	260 +0/-5 °C	5 +1/-1 seconds

Recommended temperature profile for IR reflow

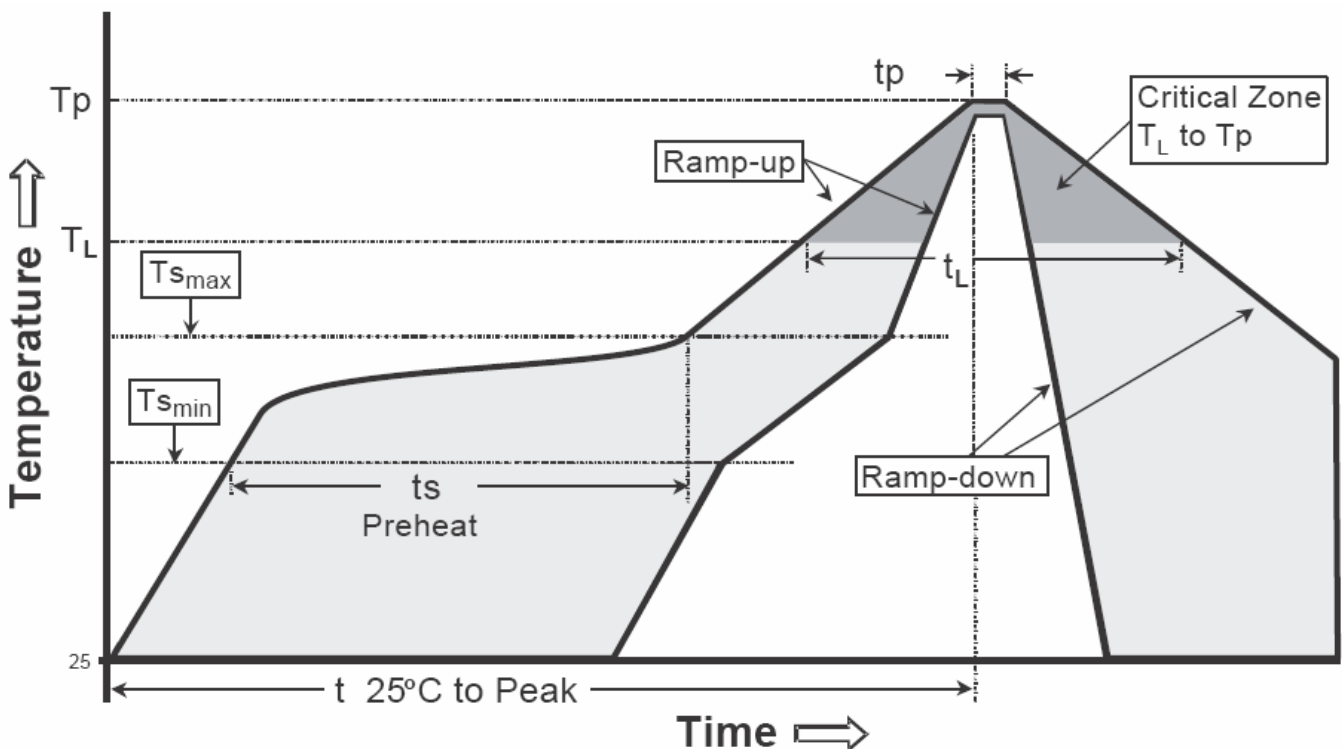

Profile feature	Sn-Pb eutectic Assembly	Pb-free Assembly
Average ramp-up rate (Tsmax to Tp)	3°C/second max.	3°C/second max.
Preheat		
-Temperature Min(Ts min)	100°C	150°C
-Temperature Max(Ts max)	150°C	200°C
-Time(ts min to ts max)	60-120 seconds	60-180 seconds
Time maintained above:		
-Temperature (TL)	183°C	217°C
- Time (tL)	60-150 seconds	60-150 seconds
Peak Temperature(TP)	240 +0/-5 °C	260 +0/-5 °C
Time within 5°C of actual peak temperature(tp)	10-30 seconds	20-40 seconds
Ramp down rate	6°C/second max.	6°C/second max.
Time 25 °C to peak temperature	6 minutes max.	8 minutes max.

Note : All temperatures refer to topside of the package, measured on the package body surface.

SMB/DO-214AA Dimension

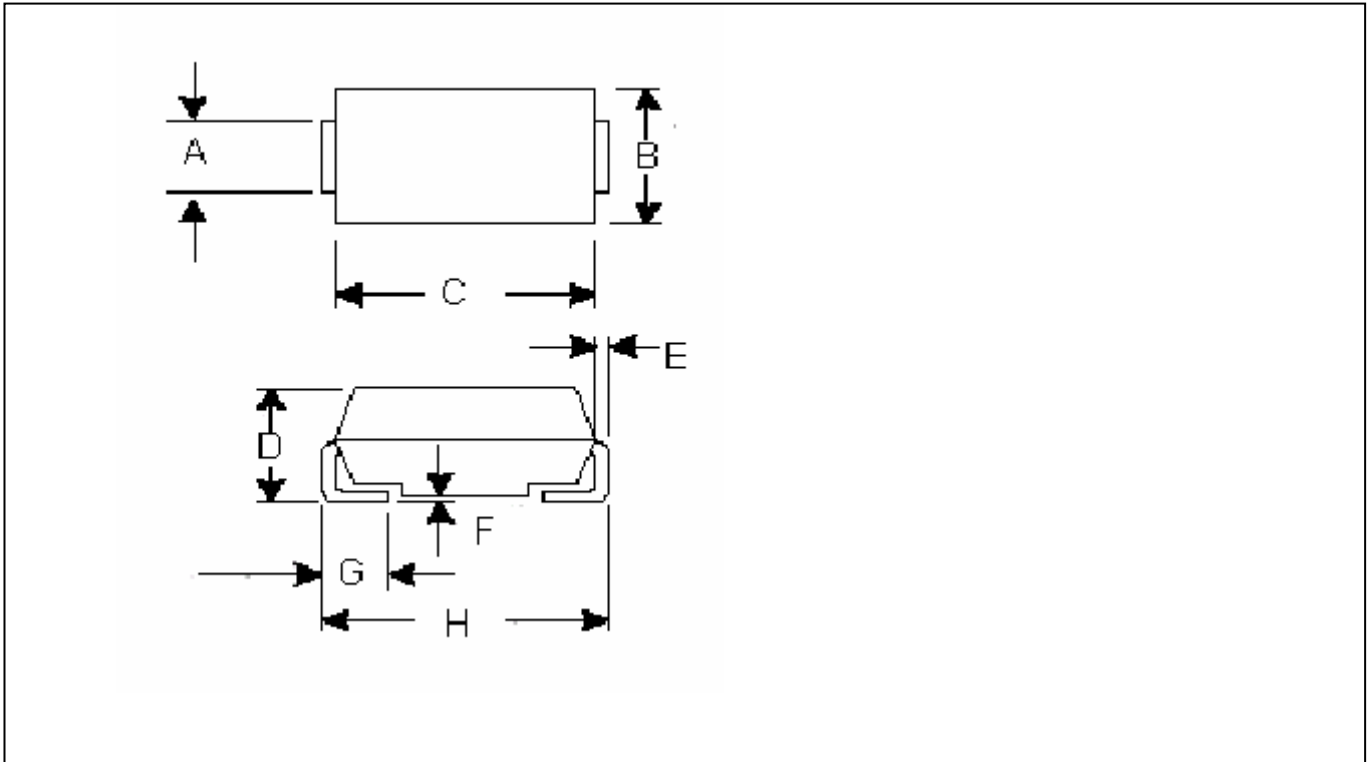

*:Typical

DIM	Inches		Millimeters		DIM	Inches		Millimeters	
	Min.	Max.	Min.	Max.		Min.	Max.	Min.	Max.
A	0.075	0.087	1.91	2.20	E	0.006	0.012	0.15	0.30
B	0.130	0.155	3.30	3.94	F	0.001	0.008	0.02	0.20
C	0.160	0.191	4.06	4.85	G	0.030	0.060	0.76	1.52
D	0.083	0.096	2.13	2.44	H	0.200	0.220	5.08	5.59

Notes : 1.Controlling dimension : millimeters.
 2.Maximum lead thickness includes lead finish thickness, and minimum lead thickness is the minimum thickness of base material.
 3.If there is any question with packing specification or packing method, please contact your local CYStek sales office.

Material :

- Lead : Pure tin plated.
- Mold Compound : Epoxy resin family, flammability solid burning class:UL94V-0.

Important Notice:

- All rights are reserved. Reproduction in whole or in part is prohibited without the prior written approval of CYStek.
- CYStek reserves the right to make changes to its products without notice.
- CYStek **semiconductor products are not warranted to be suitable for use in Life-Support Applications, or systems.**
- CYStek assumes no liability for any consequence of customer product design, infringement of patents, or application assistance.