

**5.0Amp. Surface Mount Schottky Barrier Diodes****SMB520-5100SB Series****Features**

- For surface mounted applications.
- For use in low voltage, high frequency inverters, free wheeling, and polarity protection applications
- Plastic material used carries Underwriters Laboratory Flammability Classification 94V-0
- Low leakage current
- High surge capability
- Exceeds environmental standards of MIL-S-19500/228

Mechanical Data

- Case: Molded plastic, SMB/JEDEC DO-214AA.
- Terminals: Solder plated, solderable per MIL-STD-750 method 2026
- Polarity: Indicated by cathode band.
- Mounting Position : Any.
- Weight: 0.0878 gram

Maximum Ratings and Electrical Characteristics

(Rating at 25°C ambient temperature unless otherwise specified.)

Parameter	Symbol	Type							Units
		SMB 520	SMB 530	SMB 540	SMB 550	SMB 560	SMB 580	SMB 5100	
Repetitive peak reverse voltage	V _{RRM}	20	30	40	50	60	80	100	V
Maximum RMS voltage	V _{RMS}	14	21	28	35	42	56	70	V
Maximum DC blocking voltage	V _R	20	30	40	50	60	80	100	V
Maximum instantaneous forward voltage, I _F =5A (Note 1)	V _F	0.55	0.55	0.55	0.7	0.7	0.85	0.85	V
Average forward rectified current	I _O	5							A
Peak forward surge current @8.3ms single half sine wave superimposed on rated load (JEDEC method)	I _{FSM}	150							A
Maximum DC reverse current V _R =V _{RRM} , T _A =25°C (Note) V _R =V _{RRM} , T _A =125°C (Note)	I _R	0.5 50							mA mA
Maximum thermal resistance, Junction to Lead	R _{th,JL}	12 (typ)							°C/W
Diode junction capacitance @ f=1MHz and applied 4VDC reverse voltage	C _J	380(typ)							pF
Storage temperature	T _{stg}	-55 ~ +150							°C
Operating temperature	T _J	-55 ~ +125			-55 ~ +150				°C

Notes : Pulse test, pulse width=300 μ sec, 2% duty cycle

Characteristic Curves

Forward Current Derating Curve

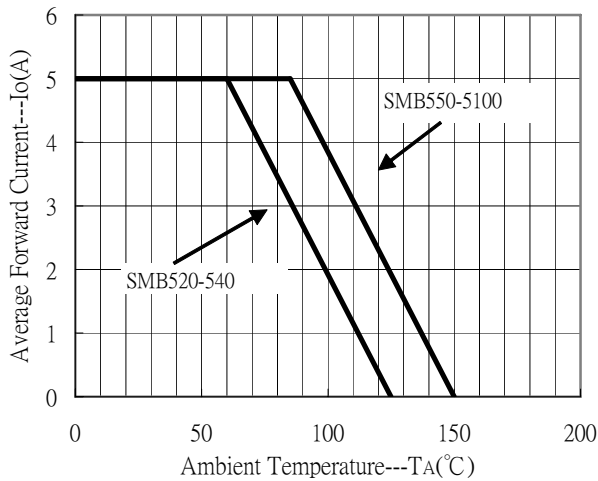

Maximum Non-Repetitive Forward Surge Current

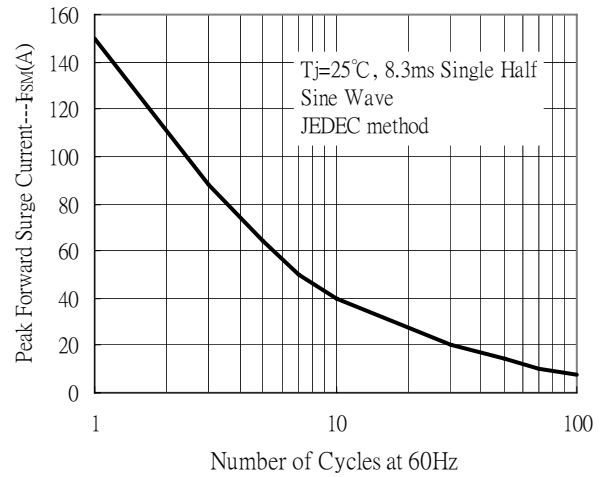

Forward Current vs Forward Voltage

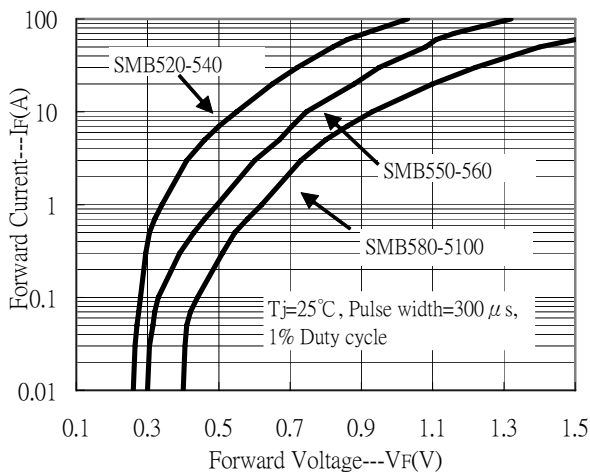

Junction Capacitance vs Reverse Voltage

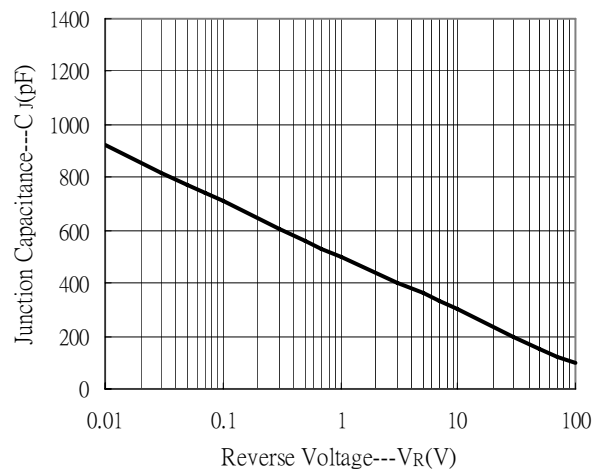

Reverse Leakage Current vs Reverse Voltage

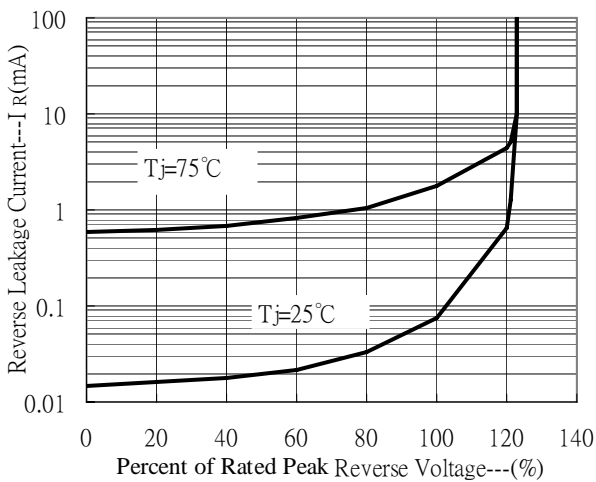

Taping Reel Dimension

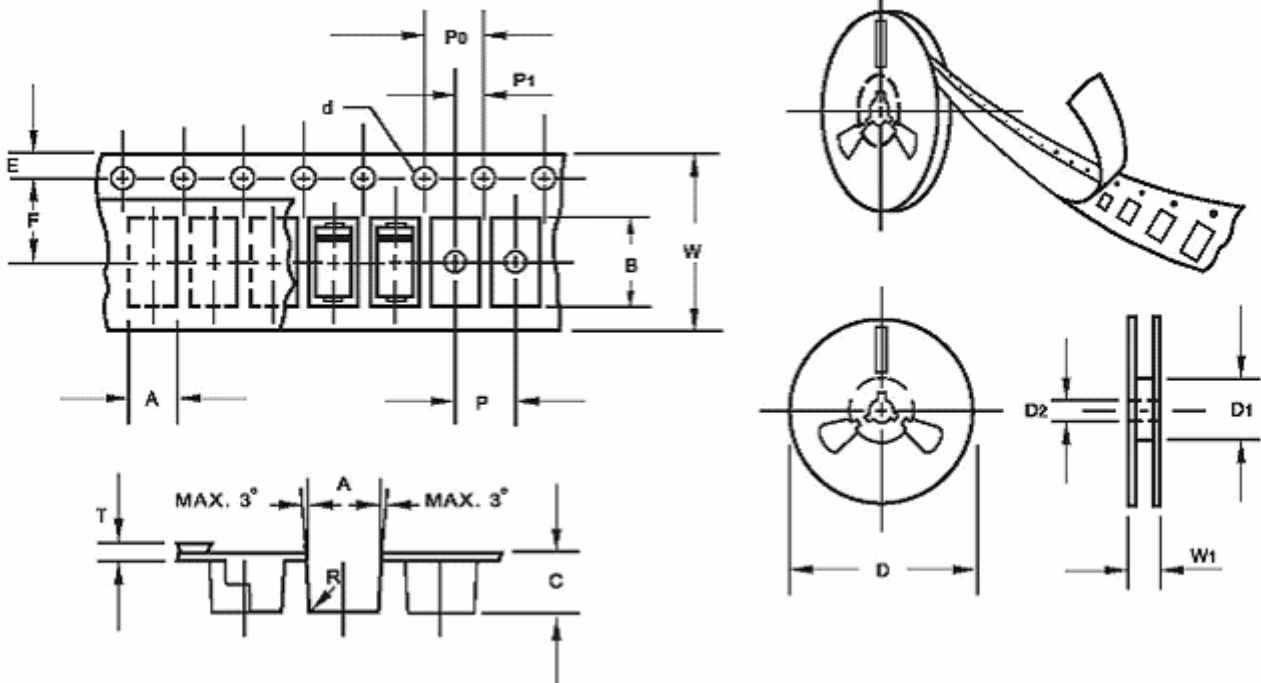

unit : mm

Item	Tolerance	Symbol	
Carrier width	0.10	A	SEE NOTE 2
Carrier length	0.10	B	
Carrier depth	0.10	C	
Sprocket hole	0.10	d	1.50
13" Reel outside diameter	2.00	D	330.0
13" Reel inner diameter	min.	D1	50.0
7" Reel outside diameter	2.00	D	178.0
7" Reel inner diameter	min.	D1	62.0
Feed hole diameter	0.50	D2	13.00
Sprocket hole position	0.10	E	1.75
Punch hole position	0.10	F	5.50
Punch hole pitch	0.10	P	8.00
Sprocket hole pitch	0.10	P0	4.00
Embossment center	0.10	P1	2.00
Tape width	0.30	W	12.00
Reel width	1.00	W1	16.80

NOTE: 1. Devices are packed in accordance with EIA standard RS-481-A and specification given above

2. A, B, and C are determined by the maximum dimensions of the component size.

The clearance between the component and the cavity must be within
 0.05mm (0.002") min. to 0.5mm (0.02") max. for 8mm tape and 12mm tape,
 0.15mm (0.066") min. to 0.90mm (0.035") max. for 16mm tape and
 0.15mm (0.066") min. to 1.0mm (0.59") max. for 24mm tape.

Recommended Wave Soldering Profile

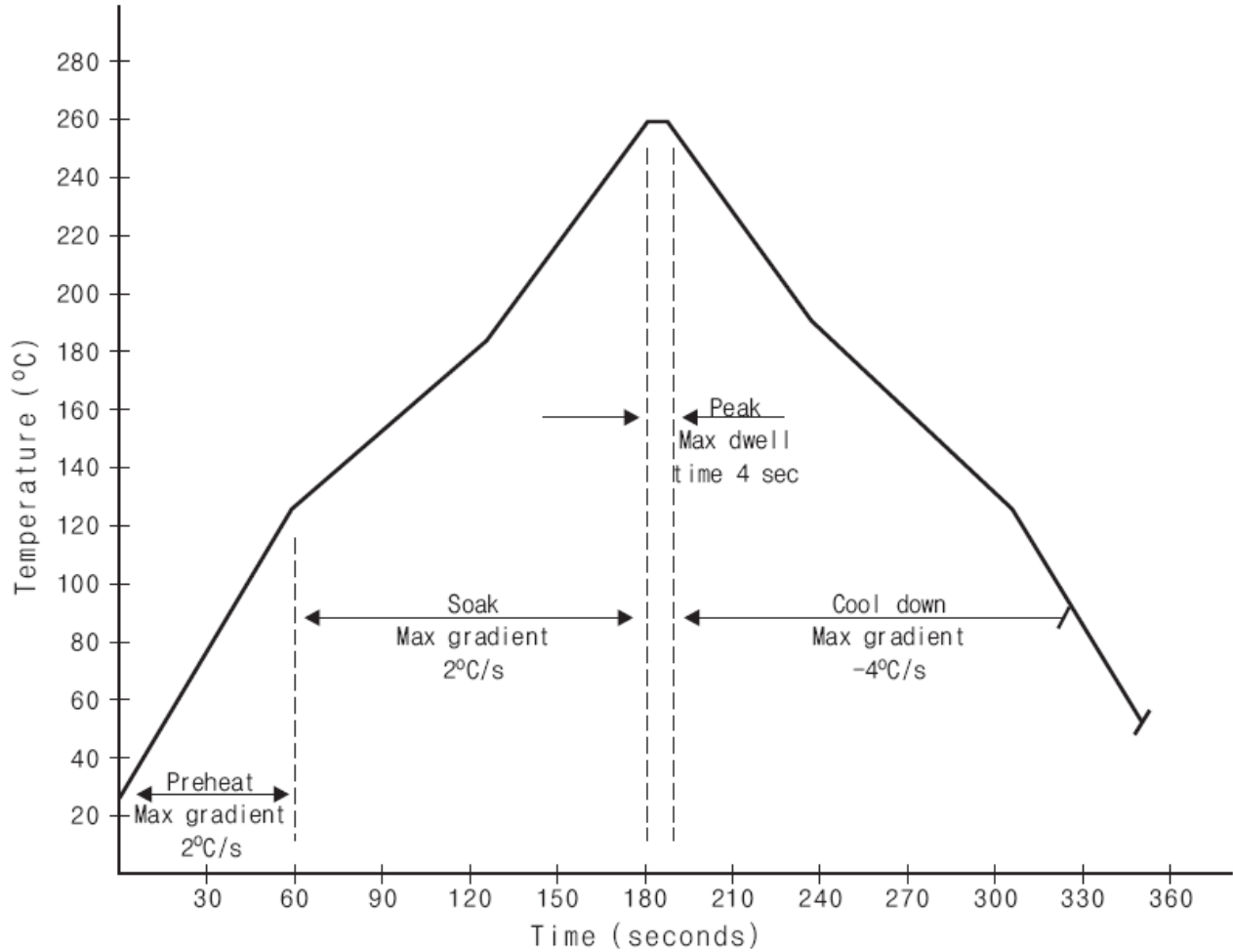

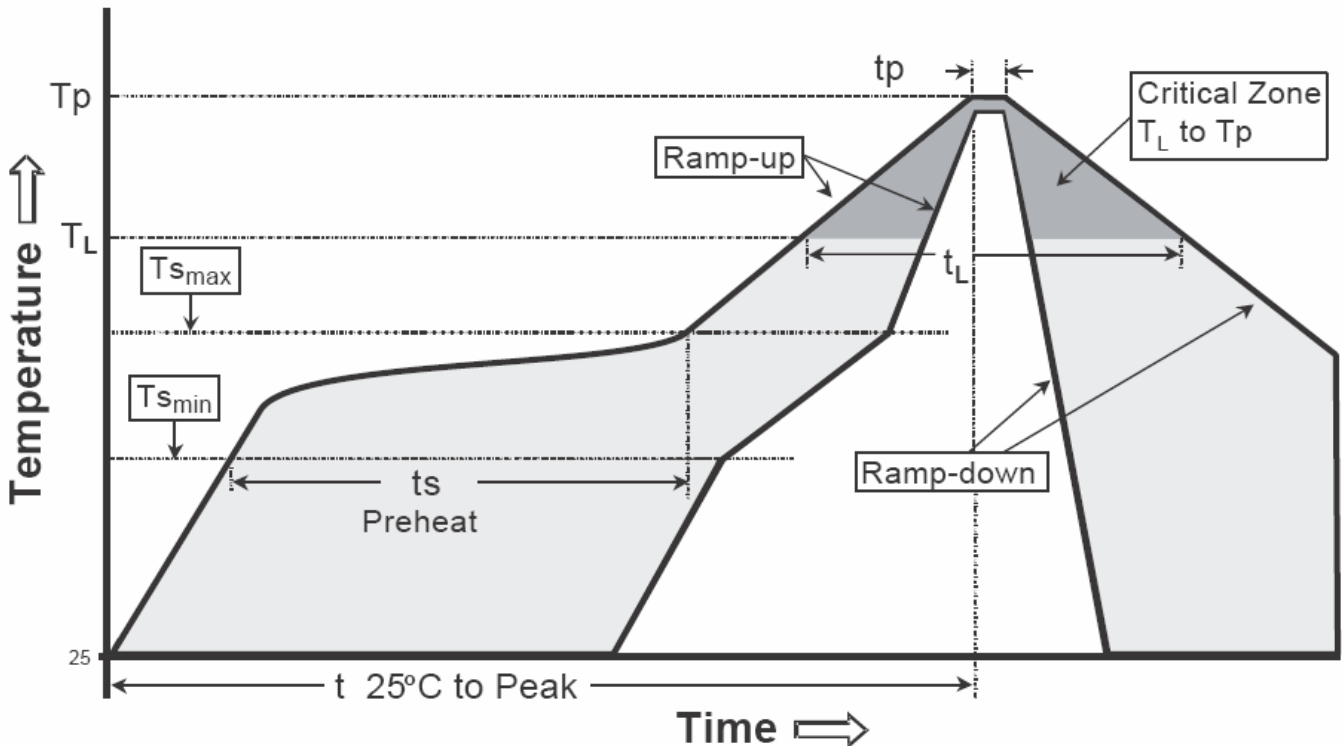
Recommended temperature profile for IR reflow

Profile feature	Sn-Pb eutectic Assembly	Pb-free Assembly
Average ramp-up rate (Tsmax to Tp)	3°C/second max.	3°C/second max.
Preheat		
-Temperature Min(Ts min)	100°C	150°C
-Temperature Max(Ts max)	150°C	200°C
-Time(ts min to ts max)	60-120 seconds	60-180 seconds
Time maintained above:		
-Temperature (TL)	183°C	217°C
- Time (tL)	60-150 seconds	60-150 seconds
Peak Temperature(TP)	240 +0/-5 °C	260 +0/-5 °C
Time within 5°C of actual peak temperature(tp)	10-30 seconds	20-40 seconds
Ramp down rate	6°C/second max.	6°C/second max.
Time 25 °C to peak temperature	6 minutes max.	8 minutes max.

Note : All temperatures refer to topside of the package, measured on the package body surface.

Recommended Footprint

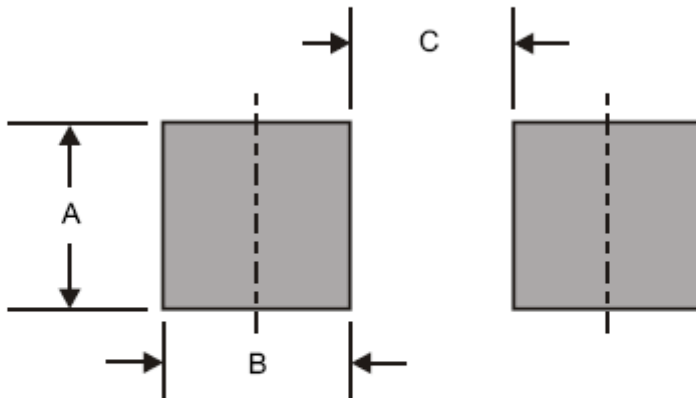

Dimensions in inches and (millimeters)

DIM	Inches	Millimeters
	Typ	Typ
A	0.142	3.60
B	0.059	1.50
C	0.118	3.00

Ordering Information

Device	Package	Shipping	Marking
SMB520SB	SMB	3000 pcs / Tape & Reel	SS52
SMB530SB	SMB	3000 pcs / Tape & Reel	SS53
SMB540SB	SMB	3000 pcs / Tape & Reel	SS54
SMB550SB	SMB	3000 pcs / Tape & Reel	SS55
SMB560SB	SMB	3000 pcs / Tape & Reel	SS56
SMB580SB	SMB	3000 pcs / Tape & Reel	SS58
SMB5100SB	SMB	3000 pcs / Tape & Reel	S510

DO-214AA/SMB Dimension

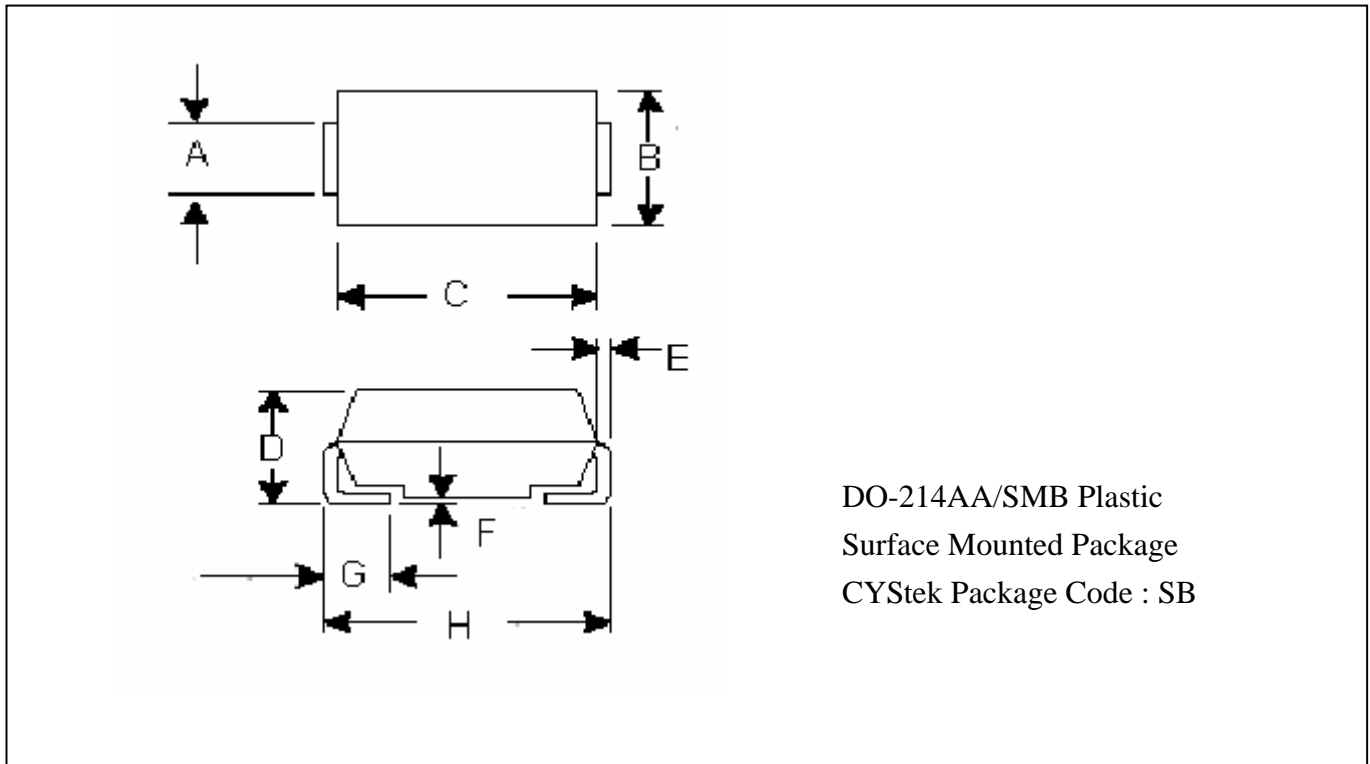

DO-214AA/SMB Plastic
 Surface Mounted Package
 CYStek Package Code : SB

*:Typical

DIM	Inches		Millimeters		DIM	Inches		Millimeters	
	Min.	Max.	Min.	Max.		Min.	Max.	Min.	Max.
A	0.076	0.082	1.93	2.08	E	0.006	0.012	0.15	0.31
B	0.137	0.147	3.48	3.73	F	0.004	0.008	0.10	0.20
C	0.167	0.187	4.25	4.75	G	0.035	0.056	0.90	1.41
D	0.078	0.103	1.99	2.61	H	0.207	0.215	5.26	5.46

Notes : 1.Controlling dimension : millimeters.
 2.Maximum lead thickness includes lead finish thickness, and minimum lead thickness is the minimum thickness of base material.
 3.If there is any question with packing specification or packing method, please contact your local CYStek sales office.

Material :

- Lead : Pure tin plated
- Mold Compound : Epoxy resin family, flammability solid burning class:UL94V-0

Important Notice:

- All rights are reserved. Reproduction in whole or in part is prohibited without the prior written approval of CYStek.
- CYStek reserves the right to make changes to its products without notice.
- CYStek **semiconductor products are not warranted to be suitable for use in Life-Support Applications, or systems.**
- CYStek assumes no liability for any consequence of customer product design, infringement of patents, or application assistance.