

**Surface Mount Transient Voltage Suppressors**  
**Peak Pulse Power 400W Stand Off Voltage 5.0 to 440V**

# SMAJ5.0 thru SMAJ440CA

## Features

- Low profile package with built-in strain relief for surface mounted applications
- Plastic package has UL flammability classification 94V-0
- Ideal for ESD protection of data line in accordance with IEC1000-4-2 (IEC801-2)
- Ideal for EFT protection of data line in accordance with IEC1000-4-4 (IEC801-4)
- Very-fast response time
- Optimized for LAN protection applications
- Low incremental surge resistance, excellent clamping capability
- Glass passivated junction
- High temperature soldering guaranteed: 250°C/10seconds at terminals
- 400W peak pulse power capability with a 10/1000µs waveform, repetition rate (duty cycle) : 0.01%

## Outline



## Mechanical Data

- Case : JEDEC DO-214AC(SMA) molded plastic body
- Terminals: Pure tin plated, solderable per MIL-STD-750 method 2026
- Polarity: For uni-directional types, the band denotes the cathode, which is positive with respect to the anode under normal TVS operation
- Mounting position : Any
- Weight: 0.002 oz., 0.064 gram

## Devices for bidirectional applications

For bi-directional devices, electrical characteristics apply in both directions.

## Maximum Ratings and Characteristics (T<sub>A</sub>=25°C, unless otherwise noted)

Parameter	Symbol	Value	Unit
Peak pulse power dissipation with a 10/1000µs waveform (Fig. 1)	PPPM	Minimum 400 (Note 1, 2)	W
Peak pulse current with a 10/1000µs waveform (Fig. 3)	IPPM	See next table (Note 1)	A
Peak forward surge current, 8.3ms single half sine wave uni-directional only (Note 2)	IFSM	40	A
Typical thermal resistance, junction-to-case	R <sub>θJC</sub>	32	°C/W
Typical thermal resistance, junction-to-ambient (Note 3)	R <sub>θJA</sub>	120	°C/W
Maximum instantaneous forward voltage at 25A for unidirectional only (Note 4)	V <sub>F</sub>	3.5 / 5.0	V
Operating junction and storage temperature range	T <sub>J</sub> ;T <sub>STG</sub>	-55 ~ +150	°C

Notes: 1. Non-repetitive current pulse, per Fig. 3 and derated above T<sub>A</sub>=25°C per Fig. 2.

2. Mounted on 0.2"×0.2" (5mm×5mm) copper pads to each terminal.

3. Mounted on minimum recommended pad layout.

4. V<sub>F</sub><3.5V for devices of V<sub>BR</sub><200V and V<sub>F</sub><5V for devices of V<sub>BR</sub>>201V.



**Electrical Characteristics** Ratings at 25°C ambient temperature, unless otherwise noted.

Part Number		Device Marking Code		Breakdown Voltage V <sub>BR</sub> @ I <sub>T</sub> (V)		Test current at I <sub>T</sub> (mA)	Reverse standoff voltage V <sub>RWM</sub> (V)	Maximum reverse leakage at V <sub>RWM</sub> I <sub>R</sub> (µA)	Maximum peak pulse Current I <sub>PPM</sub> (A)	Maximum clamping voltage at I <sub>PPM</sub> V <sub>C</sub> (V)
UNI	BI	UNI	BI	Min	Max					
SMAJ5.0	SMAJ5.0C	AD	WD	6.40	7.30	10	5.0	800	41.7	9.6
SMAJ5.0A	SMAJ5.0CA	AE	WE	6.40	7.00	10	5.0	800	43.5	9.2
SMAJ6.0	SMAJ6.0C	AF	WF	6.67	8.15	10	6.0	800	35.1	11.4
SMAJ6.0A	SMAJ6.0CA	AG	WG	6.67	7.37	10	6.0	800	38.8	10.3
SMAJ6.5	SMAJ6.5C	AH	WH	7.22	8.82	10	6.5	500	32.5	12.3
SMAJ6.5A	SMAJ6.5CA	AK	WK	7.22	7.98	10	6.5	500	35.7	11.2
SMAJ7.0	SMAJ7.0C	AL	WL	7.78	9.51	10	7.0	200	30.1	13.3
SMAJ7.0A	SMAJ7.0CA	AM	WM	7.78	8.60	10	7.0	200	33.3	12.0
SMAJ7.5	SMAJ7.5C	AN	WN	8.33	10.2	1.0	7.5	100	28.0	14.3
SMAJ7.5A	SMAJ7.5CA	AP	WP	8.33	9.21	1.0	7.5	100	31.0	12.9
SMAJ8.0	SMAJ8.0C	AQ	WQ	8.89	10.9	1.0	8.0	50	26.7	15.0
SMAJ8.0A	SMAJ8.0CA	AR	WR	8.89	9.83	1.0	8.0	50	29.4	13.6
SMAJ8.5	SMAJ8.5C	AS	WS	9.44	11.5	1.0	8.5	10	25.2	15.9
SMAJ8.5A	SMAJ8.5CA	AT	WT	9.44	10.4	1.0	8.5	10	27.8	14.4
SMAJ9.0	SMAJ9.0C	AU	WU	10.0	12.2	1.0	9.0	5.0	23.7	16.9
SMAJ9.0A	SMAJ9.0CA	AV	WV	10.0	11.1	1.0	9.0	5.0	26.0	15.4
SMAJ10	SMAJ10C	AW	WW	11.1	13.6	1.0	10	5.0	21.3	18.8
SMAJ10A	SMAJ10CA	AX	WX	11.1	12.3	1.0	10	5.0	23.5	17.0
SMAJ11	SMAJ11C	AY	WY	12.2	14.9	1.0	11	5.0	19.9	20.1
SMAJ11A	SMAJ11CA	AZ	WZ	12.2	13.5	1.0	11	5.0	22.0	18.2
SMAJ12	SMAJ12C	BD	XD	13.3	16.3	1.0	12	5.0	18.2	22.0
SMAJ12A	SMAJ12CA	BE	XE	13.3	14.7	1.0	12	5.0	20.1	19.9
SMAJ13	SMAJ13C	BF	XF	14.4	17.6	1.0	13	5.0	16.8	23.8
SMAJ13A	SMAJ13CA	BG	XG	14.4	15.9	1.0	13	5.0	18.6	21.5
SMAJ14	SMAJ14C	BH	XH	15.6	19.1	1.0	14	5.0	15.5	25.8
SMAJ14A	SMAJ14CA	BK	XK	15.6	17.2	1.0	14	5.0	17.2	23.2
SMAJ15	SMAJ15C	BL	XL	16.7	20.4	1.0	15	5.0	14.9	26.9
SMAJ15A	SMAJ15CA	BM	XM	16.7	18.5	1.0	15	5.0	16.4	24.4
SMAJ16	SMAJ16C	BN	XN	17.8	21.8	1.0	16	5.0	13.9	28.8
SMAJ16A	SMAJ16CA	BP	XP	17.8	19.7	1.0	16	5.0	15.4	26.0
SMAJ17	SMAJ17C	BQ	XQ	18.9	23.1	1.0	17	5.0	13.1	30.5
SMAJ17A	SMAJ17CA	BR	XR	18.9	20.9	1.0	17	5.0	14.5	27.6
SMAJ18	SMAJ18C	BS	XS	20.0	24.4	1.0	18	5.0	12.4	32.2
SMAJ18A	SMAJ18CA	BT	XT	20.0	22.1	1.0	18	5.0	13.7	29.2
SMAJ19	SMAJ19C	BA	XA	21.1	25.8	1.0	19	5.0	11.8	34.0
SMAJ19A	SMAJ19CA	BB	XB	21.1	23.3	1.0	19	5.0	13.0	30.8
SMAJ20	SMAJ20C	BU	XU	22.2	27.1	1.0	20	5.0	11.2	35.8
SMAJ20A	SMAJ20CA	BV	XV	22.2	24.5	1.0	20	5.0	12.3	32.4
SMAJ22	SMAJ22C	BW	XW	24.4	29.8	1.0	22	5.0	10.2	39.4
SMAJ22A	SMAJ22CA	BX	XX	24.4	26.9	1.0	22	5.0	11.3	35.5
SMAJ24	SMAJ24C	BY	XY	26.7	32.6	1.0	24	5.0	9.3	43.0
SMAJ24A	SMAJ24CA	BZ	XZ	26.7	29.5	1.0	24	5.0	10.3	38.9



**Electrical Characteristics(Cont.)**

Part Number		Device Marking Code		Breakdown Voltage V <sub>BR</sub> @ I <sub>T</sub> (V)		Test current at I <sub>T</sub> (mA)	Reverse standoff voltage V <sub>RWM</sub> (V)	Maximum reverse leakage at V <sub>RWM</sub> I <sub>R</sub> (μA)	Maximum peak pulse Current I <sub>PPM</sub> (A)	Maximum clamping voltage at I <sub>PPM</sub> V <sub>C</sub> (V)
UNI	BI	UNI	BI	Min	Max					
SMAJ26	SMAJ26C	CD	YD	28.9	35.3	1.0	26	5.0	8.6	46.6
SMAJ26A	SMAJ26CA	CE	YE	28.9	31.9	1.0	26	5.0	9.5	42.1
SMAJ28	SMAJ28C	CF	YF	31.1	38.0	1.0	28	5.0	8.0	50.0
SMAJ28A	SMAJ28CA	CG	YG	31.1	34.4	1.0	28	5.0	8.8	45.4
SMAJ30	SMAJ30C	CH	YH	33.3	40.7	1.0	30	5.0	7.5	53.5
SMAJ30A	SMAJ30CA	CK	YK	33.3	36.8	1.0	30	5.0	8.3	48.4
SMAJ33	SMAJ33C	CL	YL	36.7	44.9	1.0	33	5.0	6.8	59.0
SMAJ33A	SMAJ33CA	CM	YM	36.7	40.6	1.0	33	5.0	7.5	53.3
SMAJ36	SMAJ36C	CN	YN	40.0	48.9	1.0	36	5.0	6.2	64.3
SMAJ36A	SMAJ36CA	CP	YP	40.0	44.2	1.0	36	5.0	6.9	58.1
SMAJ40	SMAJ40C	CQ	YQ	44.4	54.3	1.0	40	5.0	5.6	71.4
SMAJ40A	SMAJ40CA	CR	YR	44.4	49.1	1.0	40	5.0	6.2	64.5
SMAJ43	SMAJ43C	CS	YS	47.8	58.4	1.0	43	5.0	5.2	76.7
SMAJ43A	SMAJ43CA	CT	YT	47.8	52.8	1.0	43	5.0	5.8	69.4
SMAJ45	SMAJ45C	CU	YU	50.0	61.1	1.0	45	5.0	5.0	80.3
SMAJ45A	SMAJ45CA	CV	YV	50.0	55.3	1.0	45	5.0	5.5	72.7
SMAJ48	SMAJ48C	CW	YW	53.3	65.1	1.0	48	5.0	4.7	85.5
SMAJ48A	SMAJ48CA	CX	YX	53.3	58.9	1.0	48	5.0	5.2	77.4
SMAJ51	SMAJ51C	CY	YY	56.7	69.3	1.0	51	5.0	4.4	91.1
SMAJ51A	SMAJ51CA	CZ	YZ	56.7	62.7	1.0	51	5.0	4.9	82.4
SMAJ54	SMAJ54C	RD	ZD	60.0	73.3	1.0	54	5.0	4.2	96.3
SMAJ54A	SMAJ54CA	RE	ZE	60.0	66.3	1.0	54	5.0	4.6	87.1
SMAJ58	SMAJ58C	RF	ZF	64.4	78.7	1.0	58	5.0	3.9	103
SMAJ58A	SMAJ58CA	RG	ZG	64.4	71.2	1.0	58	5.0	4.3	93.6
SMAJ60	SMAJ60C	RH	ZH	66.7	81.5	1.0	60	5.0	3.7	107
SMAJ60A	SMAJ60CA	RK	ZK	66.7	73.7	1.0	60	5.0	4.1	96.8
SMAJ64	SMAJ64C	RL	ZL	71.1	86.9	1.0	64	5.0	3.5	114
SMAJ64A	SMAJ64CA	RM	ZM	71.1	78.6	1.0	64	5.0	3.9	103
SMAJ70	SMAJ70C	RN	ZN	77.8	95.1	1.0	70	5.0	3.2	125
SMAJ70A	SMAJ70CA	RP	ZP	77.8	86.0	1.0	70	5.0	3.5	113
SMAJ75	SMAJ75C	RQ	ZQ	83.3	102	1.0	75	5.0	3.0	134
SMAJ75A	SMAJ75CA	RR	ZR	83.3	92.1	1.0	75	5.0	3.3	121
SMAJ78	SMAJ78C	RS	ZS	86.7	106	1.0	78	5.0	2.9	139
SMAJ78A	SMAJ78CA	RT	ZT	86.7	95.8	1.0	78	5.0	3.2	126
SMAJ80	SMAJ80C	RA	ZA	88.8	109	1.0	80	5.0	2.8	143
SMAJ80A	SMAJ80CA	RB	ZB	88.8	98	1.0	80	5.0	3.1	130
SMAJ85	SMAJ85C	RU	ZU	94.4	115	1.0	85	5.0	2.7	151
SMAJ85A	SMAJ85CA	RV	ZV	94.4	104	1.0	85	5.0	2.9	137
SMAJ90	SMAJ90C	RW	ZW	100	122	1.0	90	5.0	2.5	160
SMAJ90A	SMAJ90CA	RX	ZX	100	111	1.0	90	5.0	2.7	146
SMAJ100	SMAJ100C	RY	ZY	111	136	1.0	100	5.0	2.2	179
SMAJ100A	SMAJ100CA	RZ	ZZ	111	123	1.0	100	5.0	2.5	162



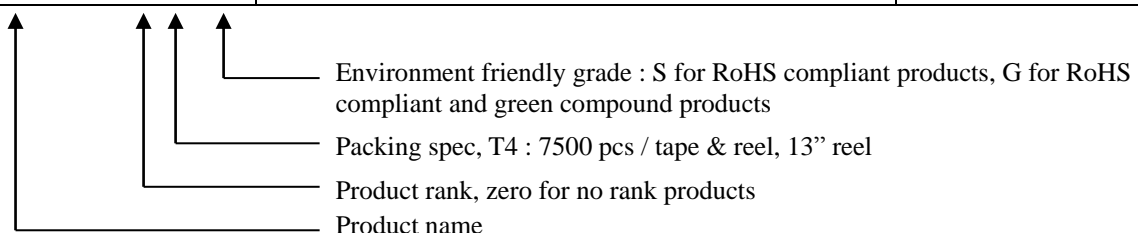
**Electrical Characteristics(Cont.)**

Part Number		Device Marking Code		Breakdown Voltage V <sub>BR</sub> @ I <sub>T</sub> (V)		Test current at I <sub>T</sub> (mA)	Reverse standoff voltage V <sub>RWM</sub> (V)	Maximum reverse leakage at V <sub>RWM</sub> I <sub>R</sub> (μA)	Maximum peak pulse Current I <sub>PPM</sub> (A)	Maximum clamping voltage at I <sub>PPM</sub> V <sub>C</sub> (V)
UNI	BI	UNI	BI	Min	Max					
SMAJ110	SMAJ110C	SD	VD	122	149	1.0	110	5.0	2.0	196
SMAJ110A	SMAJ110CA	SE	VE	122	135	1.0	110	5.0	2.3	177
SMAJ120	SMAJ120C	SF	VF	133	163	1.0	120	5.0	1.9	214
SMAJ120A	SMAJ120CA	SG	VG	133	147	1.0	120	5.0	2.1	193
SMAJ130	SMAJ130C	SH	VH	144	176	1.0	130	5.0	1.7	231
SMAJ130A	SMAJ130CA	SK	VK	144	159	1.0	130	5.0	1.9	209
SMAJ140	SMAJ140C	SA	VA	155	190	1.0	140	5.0	1.6	251
SMAJ140A	SMAJ140CA	SB	VB	155	171	1.0	140	5.0	1.8	227
SMAJ150	SMAJ150C	SL	VL	167	204	1.0	150	5.0	1.5	268
SMAJ150A	SMAJ150CA	SM	VM	167	185	1.0	150	5.0	1.7	243
SMAJ160	SMAJ160C	SN	VN	178	218	1.0	160	5.0	1.4	287
SMAJ160A	SMAJ160CA	SP	VP	178	197	1.0	160	5.0	1.5	259
SMAJ170	SMAJ170C	SQ	VQ	189	231	1.0	170	5.0	1.3	304
SMAJ170A	SMAJ170CA	SR	VR	189	209	1.0	170	5.0	1.5	275
SMAJ180	SMAJ180C	SS	VS	200	245	1.0	180	5.0	1.2	322
SMAJ180A	SMAJ180CA	ST	VT	200	222	1.0	180	5.0	1.4	292
SMAJ190	SMAJ190C	SU	VU	211	258	1.0	190	5.0	1.2	340
SMAJ190A	SMAJ190CA	SV	VV	211	232	1.0	190	5.0	1.3	308
SMAJ200A	SMAJ200CA	SW	VW	224	247	1.0	200	5.0	1.2	324
SMAJ220A	SMAJ220CA	SX	VX	246	272	1.0	220	5.0	1.1	356
SMAJ250A	SMAJ250CA	SZ	VZ	279	309	1.0	250	5.0	1.0	405
SMAJ300A	SMAJ300CA	DE	HE	335	371	1.0	300	5.0	0.8	486
SMAJ350A	SMAJ350CA	DG	HG	391	432	1.0	350	5.0	0.7	567
SMAJ400A	SMAJ400CA	DK	HK	447	494	1.0	400	5.0	0.6	648
SMAJ440A	SMAJ440CA	DM	HM	492	543	1.0	440	5.0	0.6	713

- Note: 1.Suffix 'A' denotes 5% tolerance device. Without 'A' denotes 10% tolerance device.  
 2.Add suffix 'C' or 'CA' after part number to specify bi-directional devices.  
 3.For bi-directional devices with V<sub>R</sub> of 10 volts and less, the I<sub>R</sub> limit is doubled.

**Ordering Information**

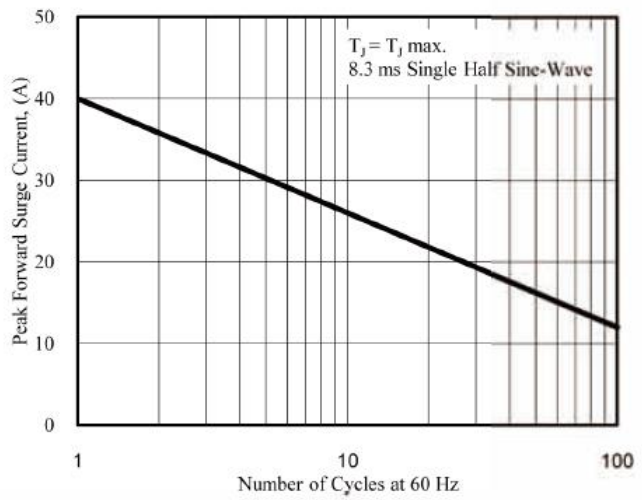
Device	Package	Shipping
SMAJXXX(A)-0-T4-G	SMA	7500 pcs / Tape & Reel
SMAJXXXC(A)-0-T4-G	(Pb-free lead plating and halogen-free package)	



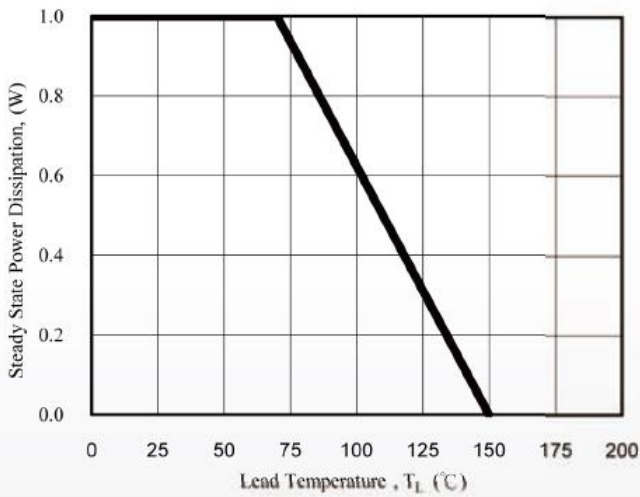
**Typical Characteristics**



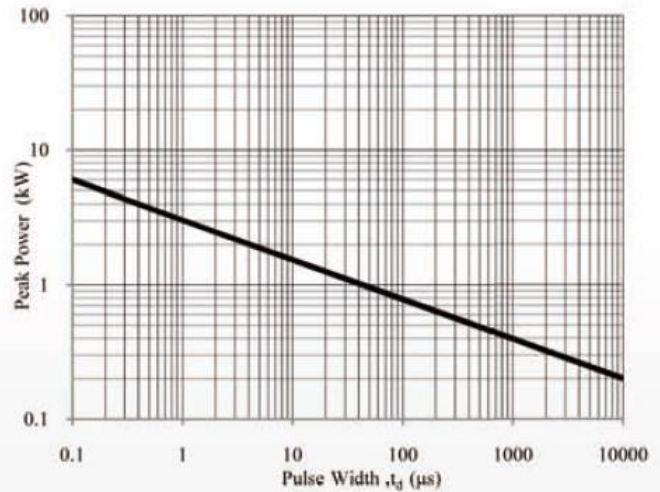
**Fig. 1 - Pulse Derating Curve**



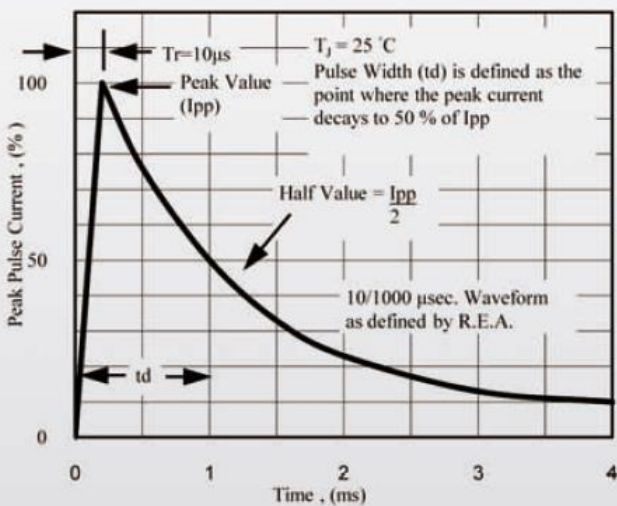
**Fig. 2 - Maximum Non-Repetitive Surge Current**



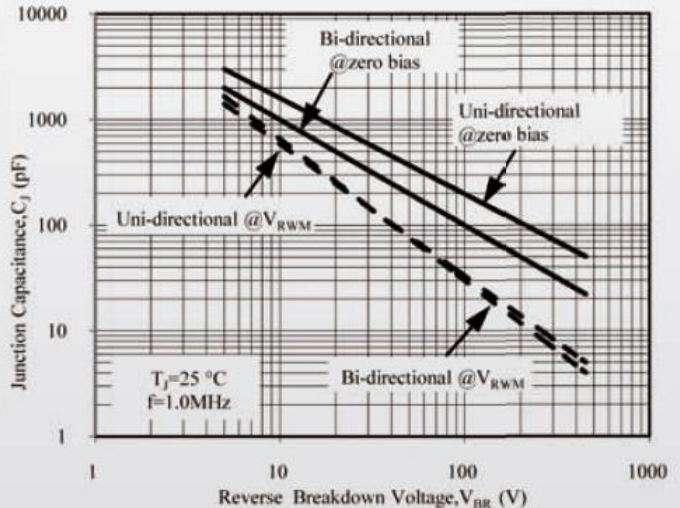
**Fig. 3 - Steady State Power Derating Curve**



**Fig. 4 - Peak Pulse Power Rating Curve**

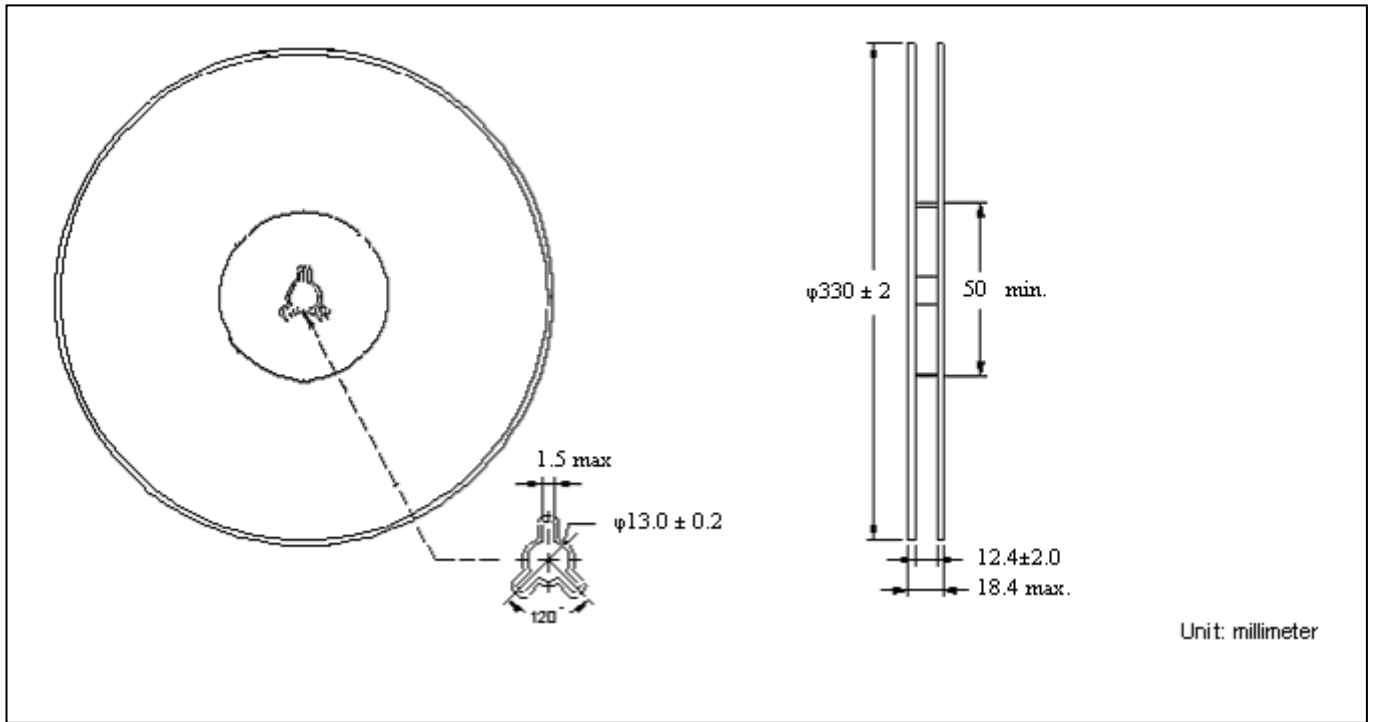


**Fig. 5 - Pulse Waveform**



**Fig. 6 - Typical Junction Capacitance**

**Reel Dimension**



**Carrier Tape Dimension**



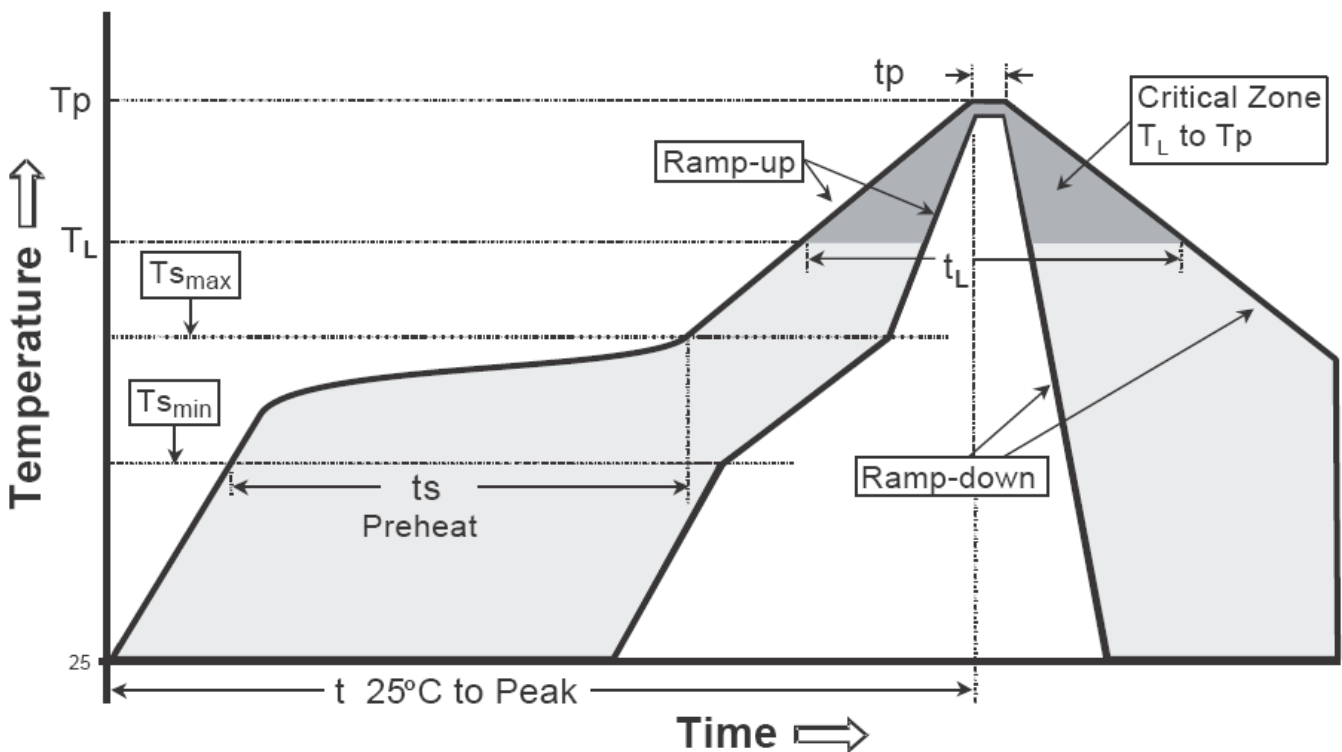
### Recommended soldering footprint



**Recommended wave soldering condition**

Product	Peak Temperature	Soldering Time
Pb-free devices	260 +0/-5 °C	5 +1/-1 seconds

**Recommended temperature profile for IR reflow**

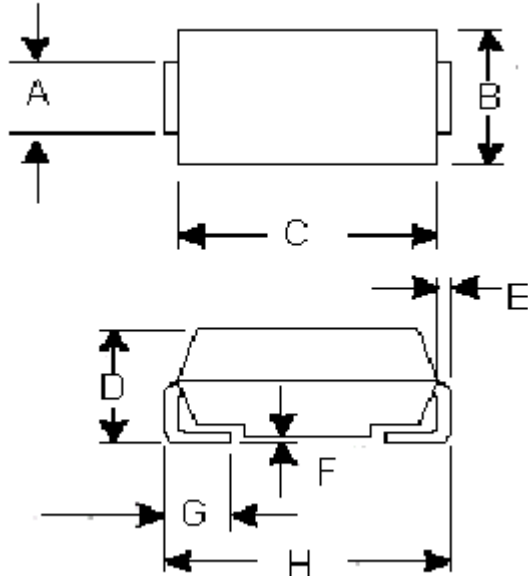


Profile feature	Sn-Pb eutectic Assembly	Pb-free Assembly
Average ramp-up rate (T <sub>smax</sub> to T <sub>p</sub> )	3°C/second max.	3°C/second max.
Preheat		
-Temperature Min(T <sub>s min</sub> )	100°C	150°C
-Temperature Max(T <sub>s max</sub> )	150°C	200°C
-Time(t <sub>s min</sub> to t <sub>s max</sub> )	60-120 seconds	60-180 seconds
Time maintained above:		
-Temperature (T <sub>L</sub> )	183°C	217°C
- Time (t <sub>L</sub> )	60-150 seconds	60-150 seconds
Peak Temperature(T <sub>p</sub> )	240 +0/-5 °C	260 +0/-5 °C
Time within 5°C of actual peak temperature(tp)	10-30 seconds	20-40 seconds
Ramp down rate	6°C/second max.	6°C/second max.
Time 25 °C to peak temperature	6 minutes max.	8 minutes max.

Note : All temperatures refer to topside of the package, measured on the package body surface.



**DO-214AC/SMA Dimension**



DO-214AC/SMA Plastic  
 Surface Mounted Package  
 CYStek Package Code : SA

\*:Typical

DIM	Inches		Millimeters		DIM	Inches		Millimeters	
	Min.	Max.	Min.	Max.		Min.	Max.	Min.	Max.
A	0.048	0.064	1.23	1.63	E	0.006	0.012	0.15	0.31
B	0.095	0.109	2.40	2.76	F	0.000	0.008	0.00	0.20
C	0.157	0.181	4.00	4.60	G	0.030	0.059	0.75	1.51
D	0.075	0.089	1.90	2.26	H	0.189	0.206	4.80	5.22

Notes : 1.Controlling dimension : millimeters.  
 2.Maximum lead thickness includes lead finish thickness, and minimum lead thickness is the minimum thickness of base material.  
 3.If there is any question with packing specification or packing method, please contact your local CYStek sales office.

**Material :**

- Lead : Pure tin plated.
- Mold Compound : Epoxy resin family, flammability solid burning class:UL94V-0.

**Important Notice:**

- All rights are reserved. Reproduction in whole or in part is prohibited without the prior written approval of CYStek.
- CYStek reserves the right to make changes to its products without notice.
- CYStek **semiconductor products are not warranted to be suitable for use in Life-Support Applications, or systems.**
- CYStek assumes no liability for any consequence of customer product design, infringement of patents, or application assistance.