

5Amp. MOS BARRIER RECTIFIER

SKM0545UAF

$I_{F(AV)}$	5A
V_{RRM}	45V
V_F at 125°C	0.42V
T_j	150°C

Features

- 150°C operating junction temperature
- Softest, fast switching capability
- Reduced ultra-low forward voltage drop (VF) ; better efficiency and cooler operation.
- Lead-Free Finish; RoHS Compliant
- Halogen and Antimony Free. “Green” Device
- MCD technology provides a superior avalanche capability than schottky diodes

Mechanical Data

- Case: SMAF molded plastic
- Mounting Position: Any
- Weight: 0.068 grams (approximate)
- Terminals: Pure tin plated, solderable per JESD22-B102
- Epoxy: UL 94V-0 rate flame retardant
- Polarity : As marked.

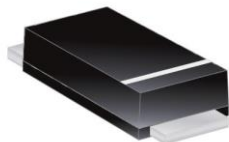

SMAF



Anode

Cathode

Ordering Information

Device	Package	Shipping
SKM0545UAF-0-T4-G	SMAF (RoHS compliant package)	7500/Tape & Reel

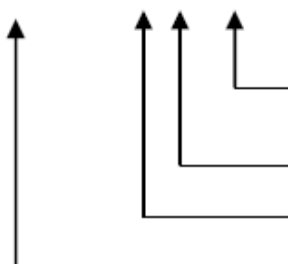

Environment friendly grade : S for RoHS compliant products, G for RoHS compliant and green compound products

Packing spec, T4 : 7500 pcs / tape & reel, 13"reel

Product rank, zero for no rank products

Product name

Marking Information

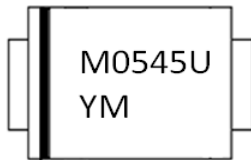

M0545U = Product Type Marking Code

Y M = Date Code Marking

Y = Last One Digits of Year (ex: 4 for 2014)

M = Month code (1 ~ 9、10→A、11→B、12→C)

Maximum Ratings and Electrical Characteristics

(Rating at 25°C ambient temperature unless otherwise specified. Single phase, half wave, 60Hz, resistive or inductive load. For capacitive load, derate current by 20%.)

Parameter	Symbol	Min.	Typ.	Max.	Units
Maximum DC blocking voltage	V _{DC}			45	V
Maximum Recurrent peak reverse voltage	V _{RRM}			45	V
Maximum RMS voltage	V _{RMS}			32	V
Maximum instantaneous forward voltage at I _F =5A	V _F	T _C =25°C	0.46	0.49	V
		T _C =125°C	0.43	0.45	
Maximum instantaneous reverse current at	I _R	V _R =45 V, T _C =25°C	60	300	μA
		V _R =45 V, T _C =125°C	15	35	mA
Maximum Average forward rectified current @ T _C =100°C	I _{F(AV)}			5	A
Non-repetitive peak forward surge current @ 8.3ms single half sine wave superimposed on rated load (JEDEC method)	I _{FSM}	120			A
Peak Repetitive Reverse Surge Current (2uS-1Khz)	I _{RRM}			2	A
Storage temperature range	T _{stg}	-55		150	°C
Operating junction temperature range	T _J	-55		150	°C

Thermal Data

Parameter	Symbol	Value	Unit
Typical Thermal Resistance, Junction-to-ambient(1)	R _{th,j-a}	38	°C/W
Typical Resistance, Junction-to-case(2)	R _{th,j-c}	31	°C/W

Note

- FR-4 PCB, 2oz. Copper. Minimum recommended pad layout.
- Short duration pulse test used to minimize self-heating effect.

Typical Characteristics

Forward Current Derating Curve

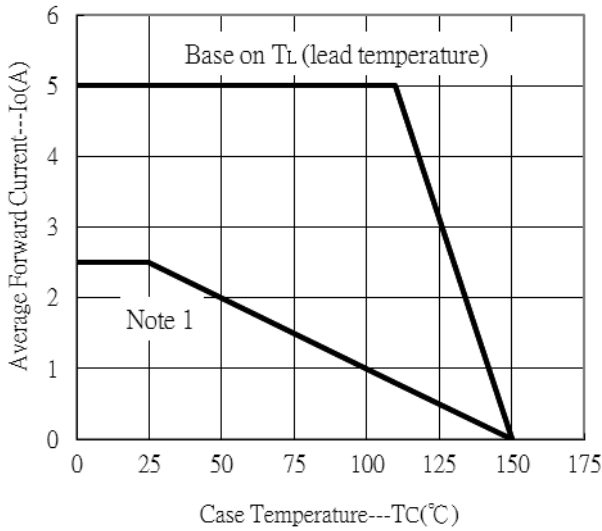

Forward Current vs Forward Voltage

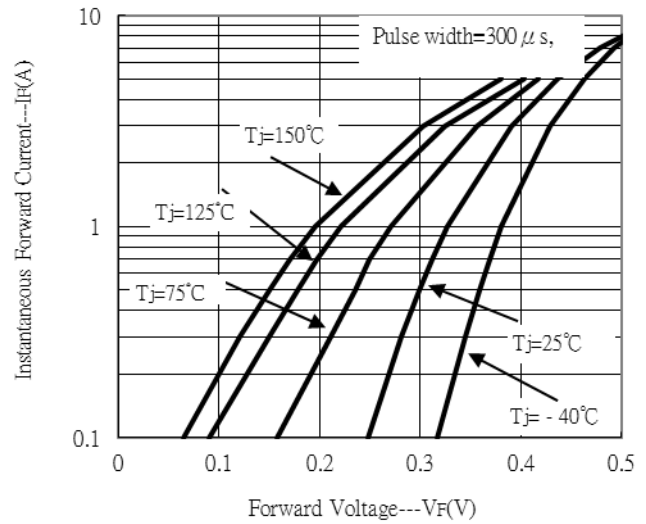

Reverse Leakage Current vs Reverse Voltage

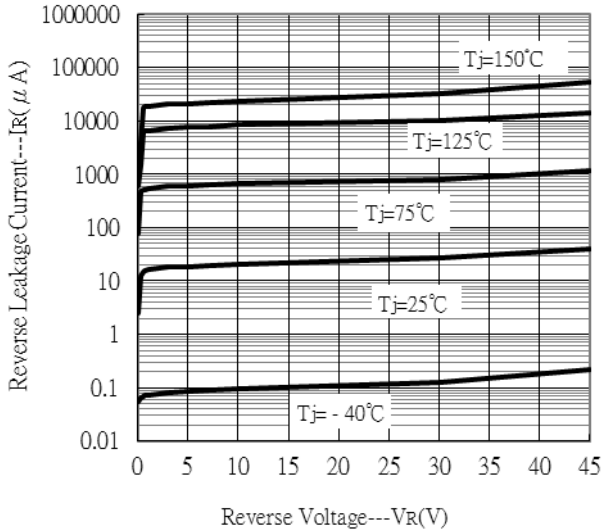

Junction Capacitance vs Reverse Voltage

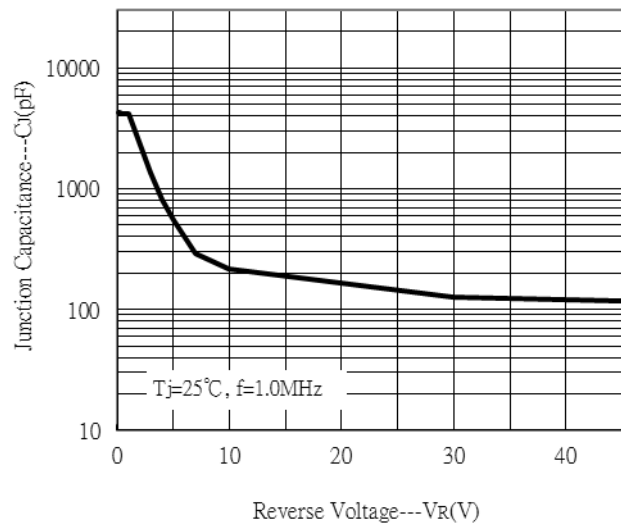

Recommended wave soldering condition

Product	Peak Temperature	Soldering Time
Pb-free devices	260 +0/-5 °C	5 +1/-1 seconds

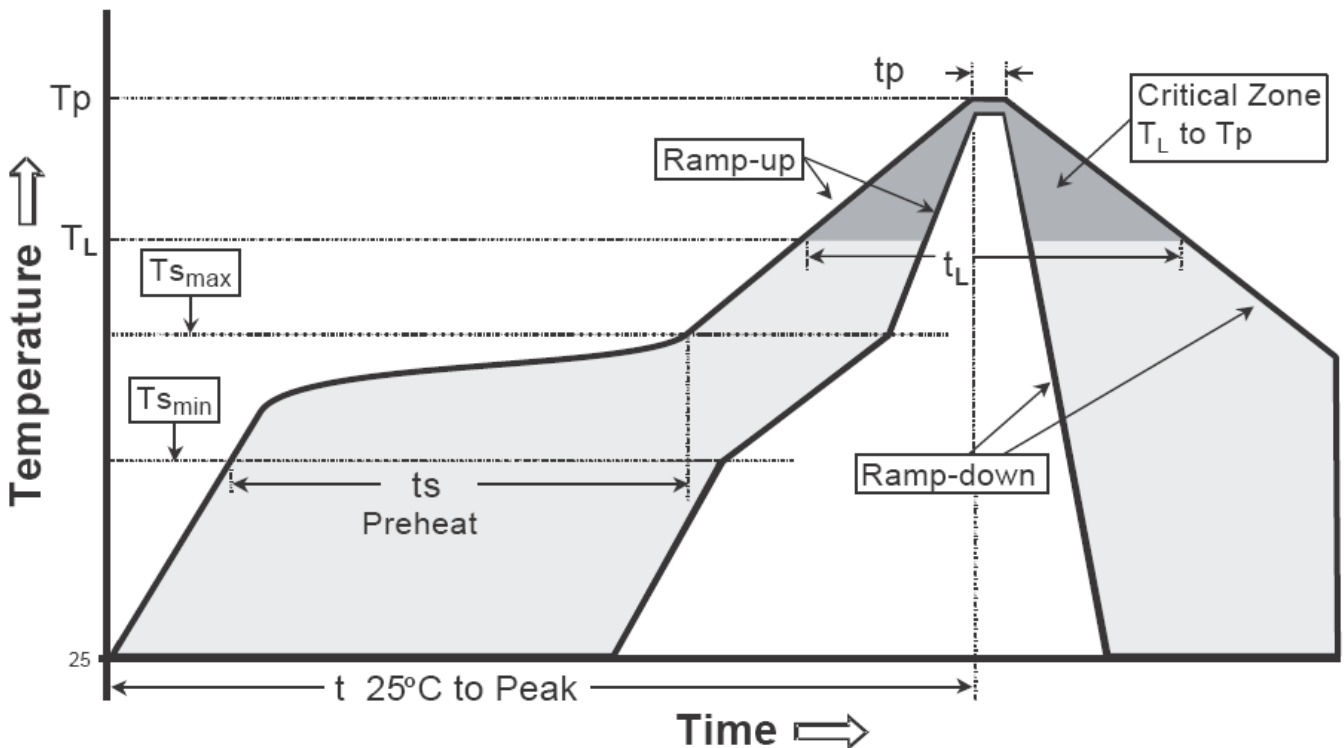
Recommended temperature profile for IR reflow

Profile feature	Sn-Pb eutectic Assembly	Pb-free Assembly
Average ramp-up rate (Tsmax to Tp)	3°C/second max.	3°C/second max.
Preheat		
-Temperature Min(Ts min)	100°C	150°C
-Temperature Max(Ts max)	150°C	200°C
-Time(ts min to ts max)	60-120 seconds	60-180 seconds
Time maintained above:		
-Temperature (TL)	183°C	217°C
- Time (tL)	60-150 seconds	60-150 seconds
Peak Temperature(TP)	240 +0/-5 °C	260 +0/-5 °C
Time within 5°C of actual peak temperature(tp)	10-30 seconds	20-40 seconds
Ramp down rate	6°C/second max.	6°C/second max.
Time 25 °C to peak temperature	6 minutes max.	8 minutes max.

Note : All temperatures refer to topside of the package, measured on the package body surface.

SMAF Dimension

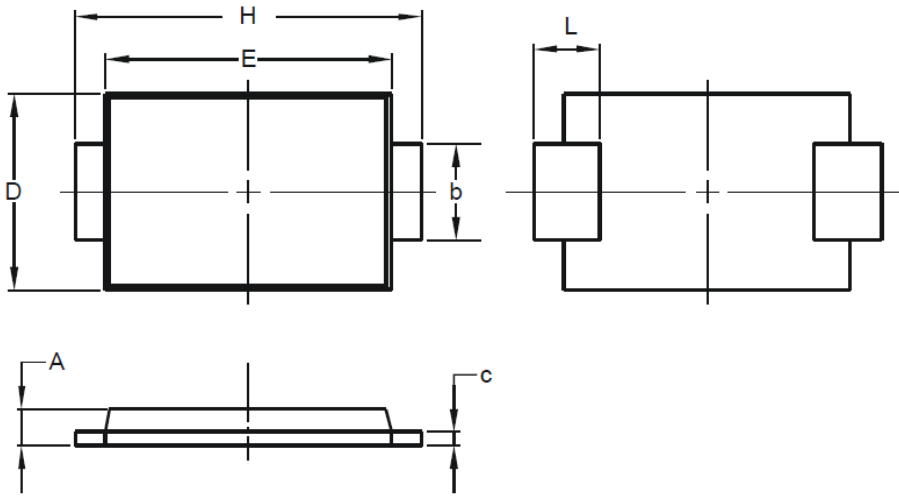

SMAF		
Dim	Min	Max
A	1.3	1.8
b	1.25	1.75
c	0.1	0.3
D	2.25	2.75
E	4.15	4.65
H	4.5	5.5
L	0.7	1.3
All Dimensions in mm		

Mounting Pad Layout

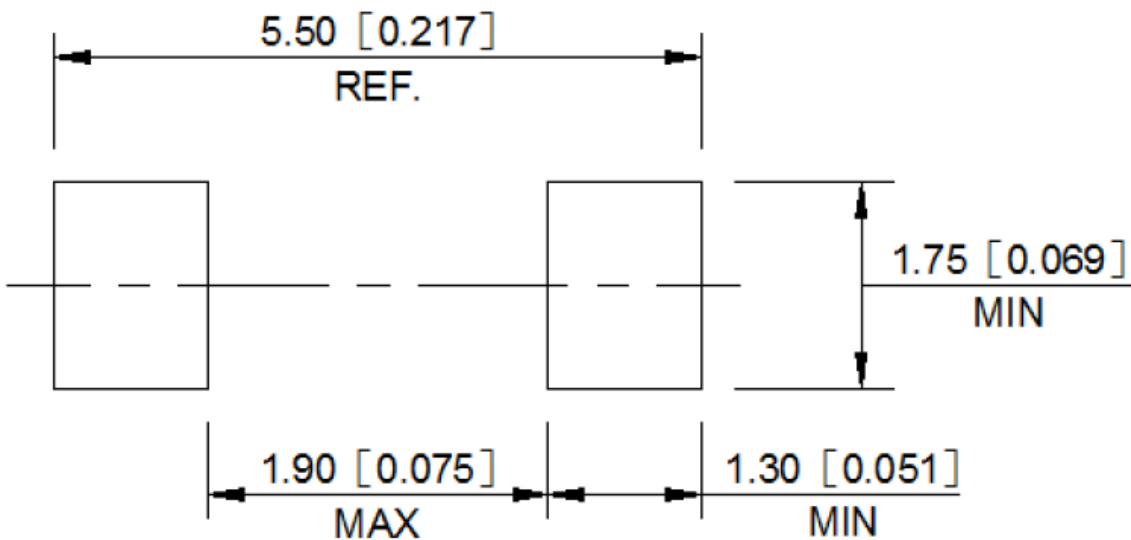

Packing Information

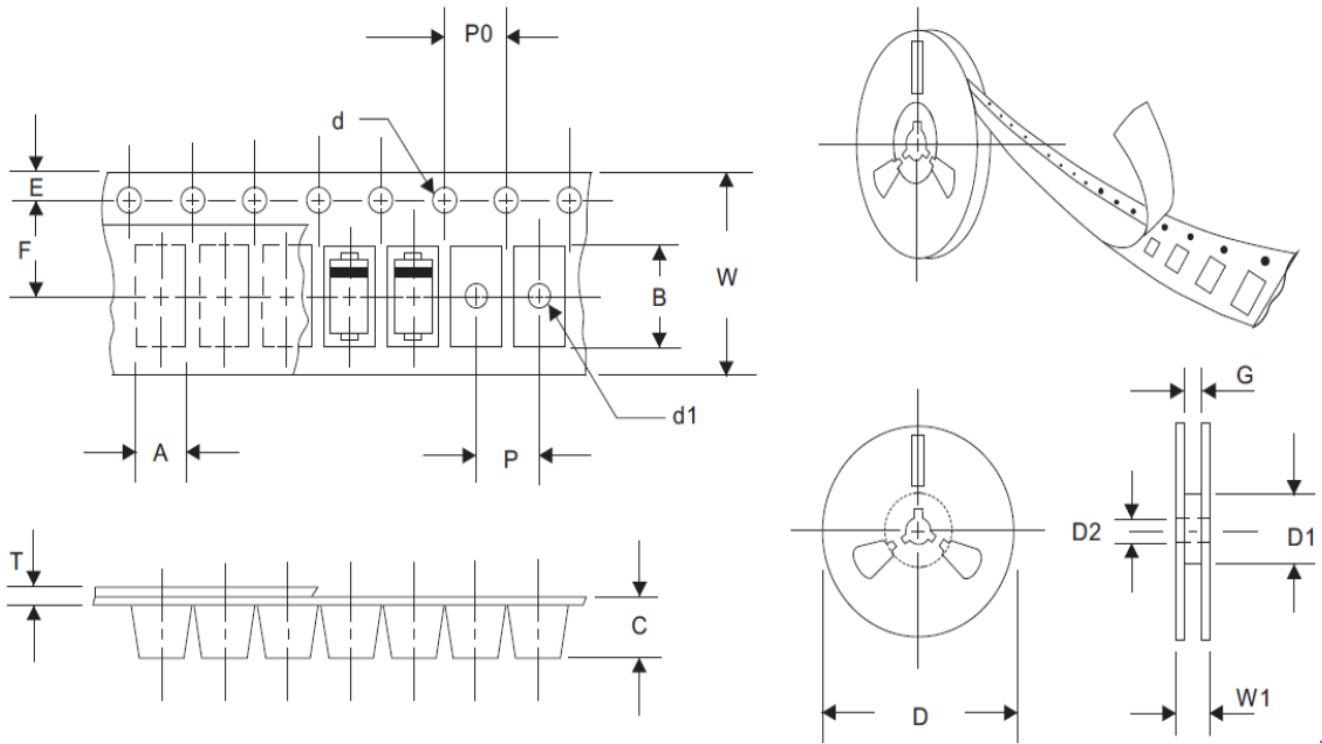

W	A	B	C	d1	d	E	F	P	P0	T	D	D1	D2	G	W1
12	2.9	5.5	2.1	1.5	1.5	1.75	5.5	4	4	0.3	330	105	13	12.4	18

Unit : mm

Important Notice:

- All rights are reserved. Reproduction in whole or in part is prohibited without the prior written approval of CYStek.
- CYStek reserves the right to make changes to its products without notice.
- CYStek **semiconductor products are not warranted to be suitable for use in Life-Support Applications, or systems.**
- CYStek assumes no liability for any consequence of customer product design, infringement of patents, or application assistance.