



5.0Amp. Surface Mount Schottky Barrier Diodes

SK520AF thru SK5100AF

Features

- For surface mounted applications.
- For use in low voltage, high frequency inverters, free wheeling, and polarity protection applications
- Plastic material used carries Underwriters Laboratory Flammability Classification 94V-0
- Low leakage current
- High surge capability
- Exceeds environmental standards of MIL-S-19500/228

Mechanical Data

- Case: Molded plastic, SMA-S/JEDEC DO-214AC
- Terminals: Solder plated, solderable per MIL-STD-202 method 208
- Polarity: Indicated by cathode band.
- Mounting Position : Any.
- Weight: 0.057 gram, 0.0017 ounce

Ordering Information

Device	Package	Shipping
SK5X0AF-0-T4-G	SMA-S (Pb-free lead plating and halogen-free package)	7500 pcs / Tape & Reel

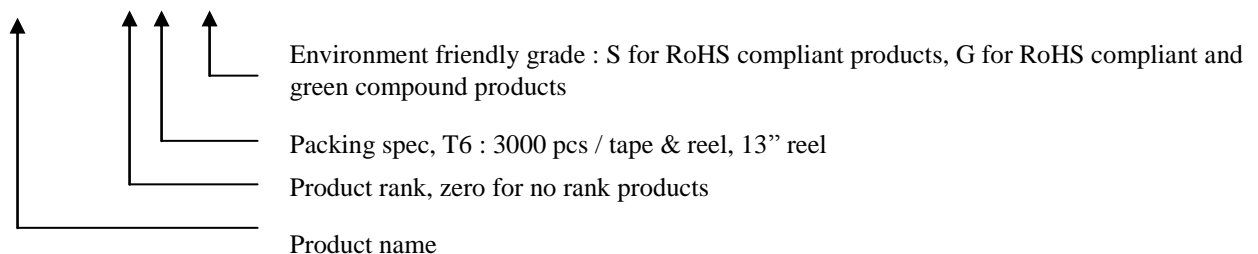

Maximum Ratings and Electrical Characteristics

(Rating at 25°C ambient temperature unless otherwise specified.)

Parameter	Symbol	Type							Units
		SK 520	SK 530	SK 540	SK 550	SK 560	SK 580	SK 5100	
Repetitive peak reverse voltage	V _{RRM}	20	30	40	50	60	80	100	V
Maximum RMS voltage	V _{RMS}	14	21	28	35	42	56	70	V
Maximum DC blocking voltage	V _R	20	30	40	50	60	80	100	V
Maximum instantaneous forward voltage, I _F =5A (Note 1)	V _F	0.55	0.55	0.55	0.7	0.7	0.85	0.85	V
Average forward rectified current	I _O	5							A
Peak forward surge current @8.3ms single half sine wave superimposed on rated load (JEDEC method)	I _{FSM}	150							A
Maximum DC reverse current V _R =V _{RRM} , T _A =25°C (Note) V _R =V _{RRM} , T _A =125°C (Note)	I _R	0.5 50							mA mA
Maximum thermal resistance, Junction to Case.Max	R _{th,JC}	31							°C/W
Diode junction capacitance @ f=1MHz and applied 4VDC reverse voltage	C _J	380(typ)							pF
Storage temperature	T _{stg}	-55 ~ +150							°C
Operating temperature	T _J	-55 ~ +125					-55 ~ +150		°C

Notes : Pulse test, pulse width=300 μ sec, 2% duty cycle

Recommended Pad Layout

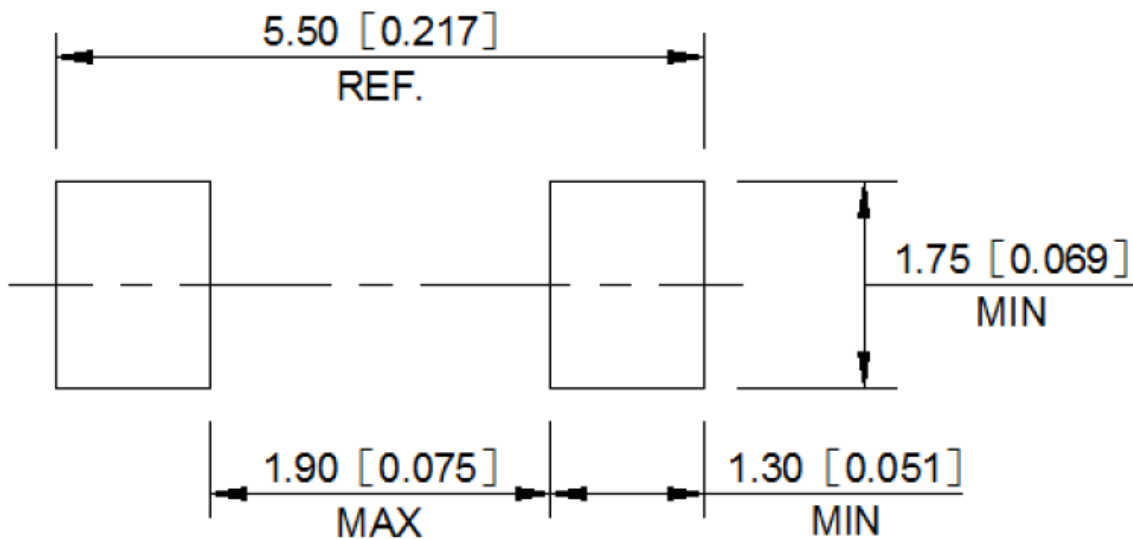

Typical Characteristics

Forward Current Derating Curve

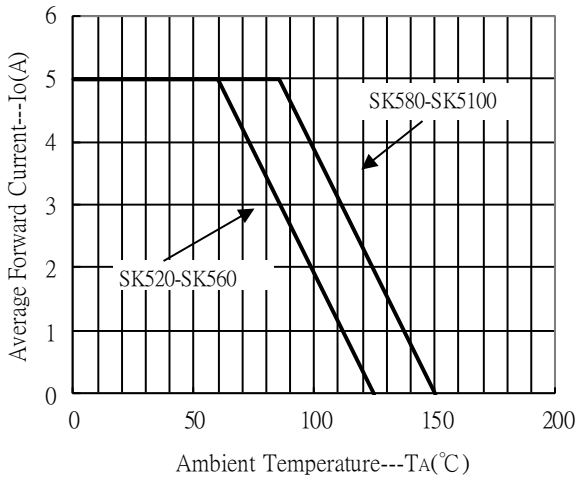

Maximum Non-Repetitive Forward

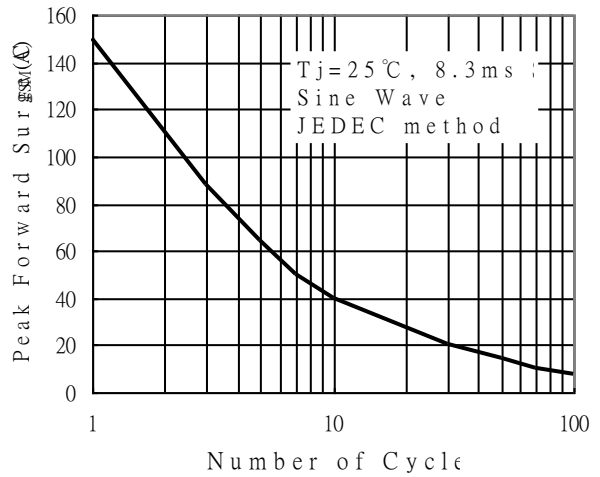

Forward Current vs Forward Voltage

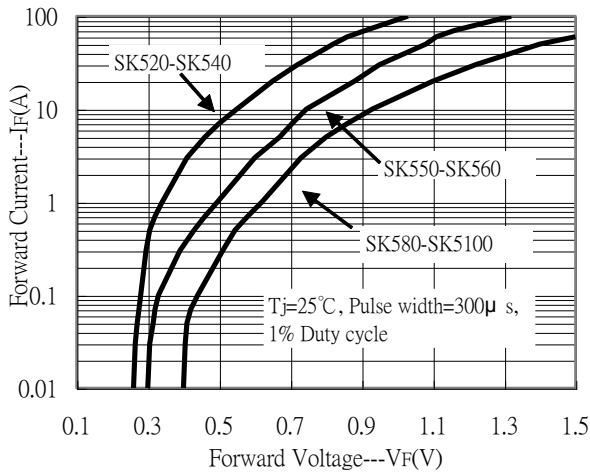

Junction Capacitance vs Reverse Voltage

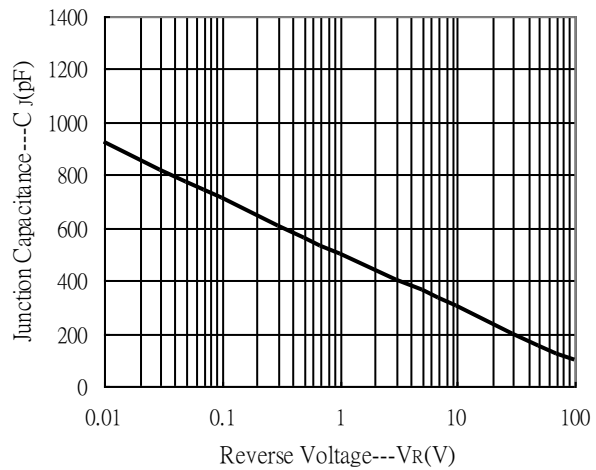

Reverse Leakage Current vs Reverse Voltage

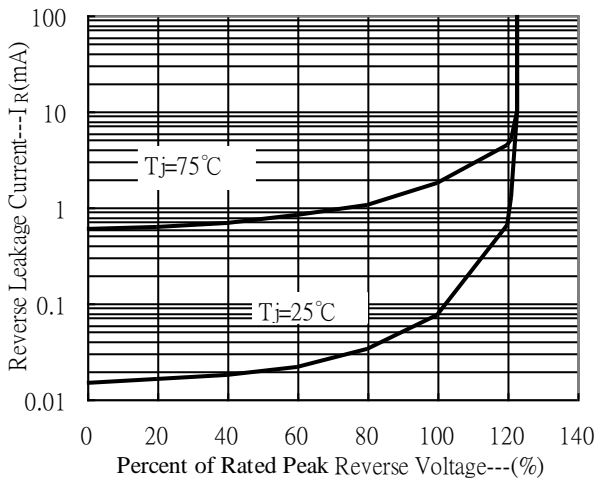

Taping Reel Dimension

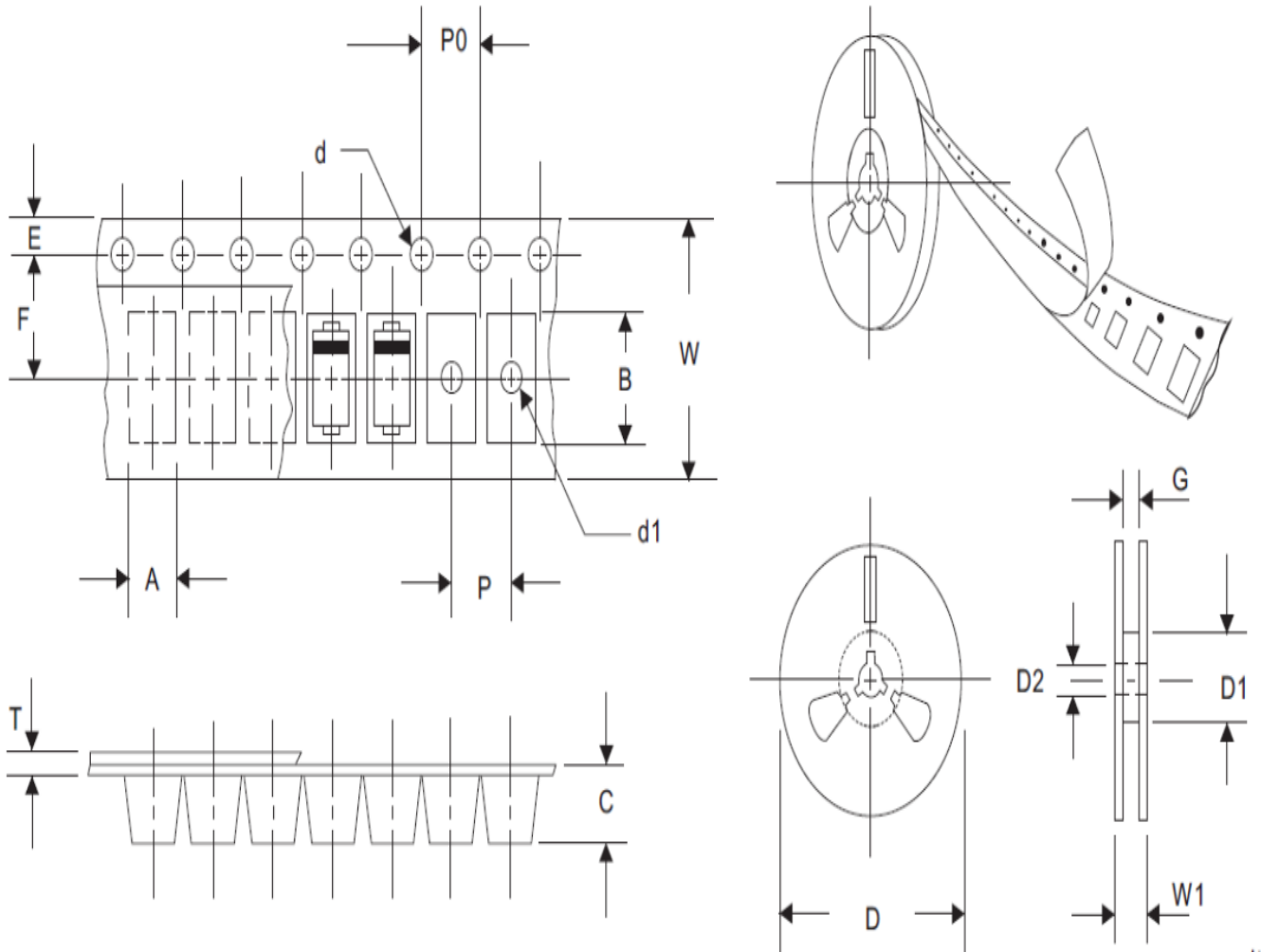

W	A	B	C	d1	d	E	F	P	P0	T	D	D1	D2	G	W1
12	2.9	5.5	2.1	1.5	1.5	1.75	5.5	4	4	0.3	330	105	13	12.4	18

Unit : mm

Recommended temperature profile for IR reflow

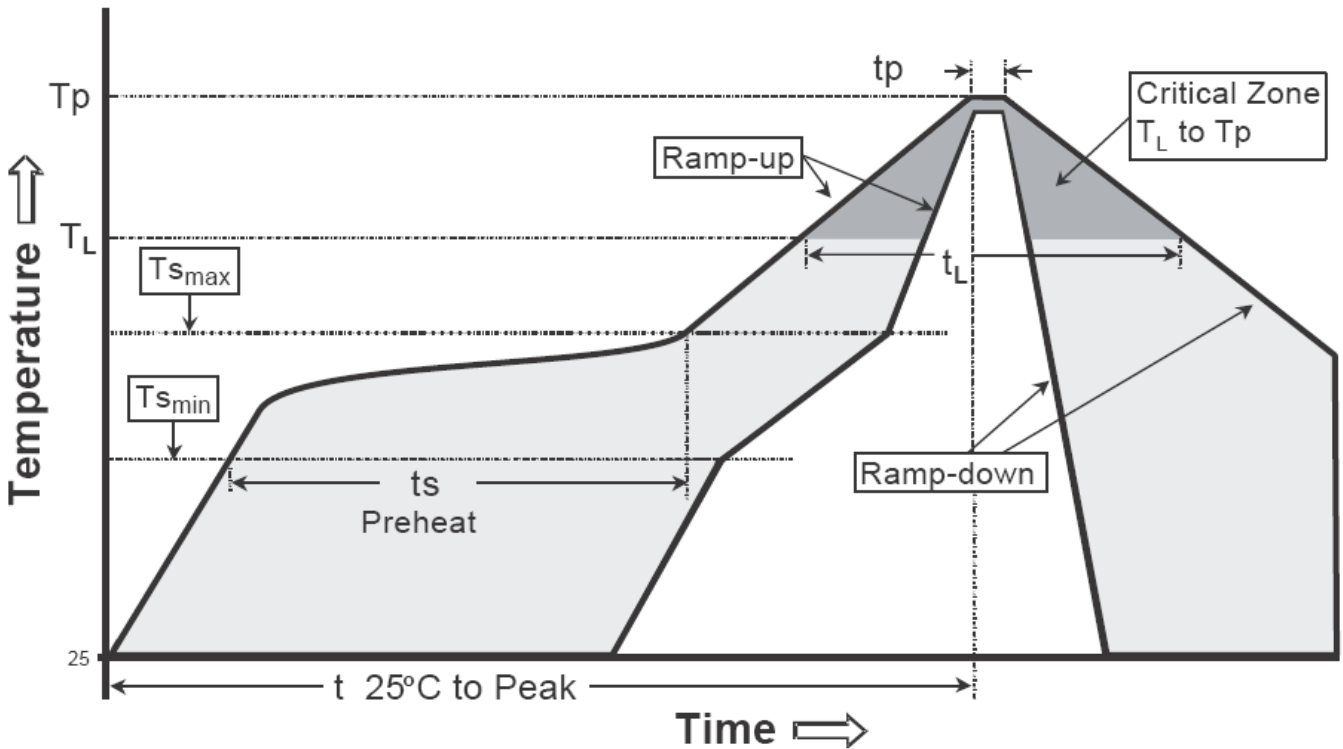

Profile feature	Sn-Pb eutectic Assembly	Pb-free Assembly
Average ramp-up rate (Tsmax to Tp)	3°C/second max.	3°C/second max.
Preheat		
-Temperature Min(T_s min)	100°C	150°C
-Temperature Max(T_s max)	150°C	200°C
-Time($t_{s\ min}$ to $t_{s\ max}$)	60-120 seconds	60-180 seconds
Time maintained above:		
-Temperature (T_L)	183°C	217°C
- Time (t_L)	60-150 seconds	60-150 seconds
Peak Temperature(T_p)	240 +0/-5 °C	260 +0/-5 °C
Time within 5°C of actual peak temperature(t_p)	10-30 seconds	20-40 seconds
Ramp down rate	6°C/second max.	6°C/second max.
Time 25 °C to peak temperature	6 minutes max.	8 minutes max.

Note : All temperatures refer to topside of the package, measured on the package body surface.

DO-214AC/SMA-S Dimension & Marking Code :

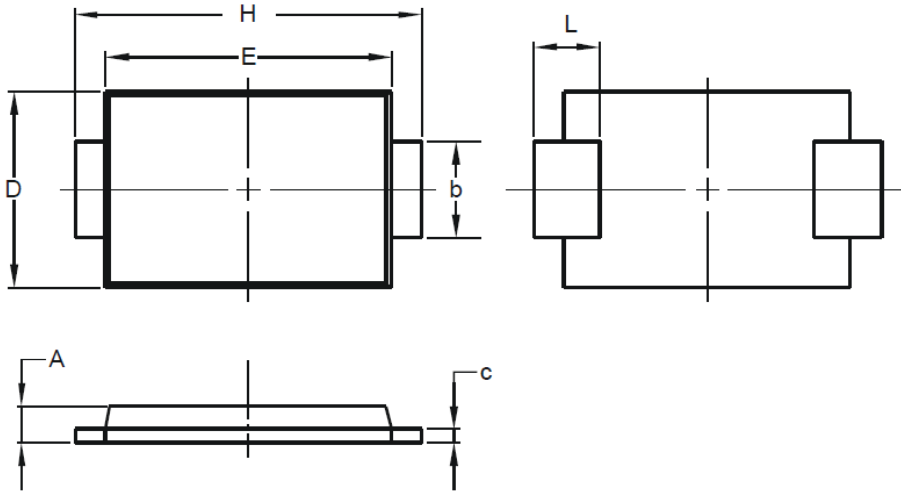

SMA-S		
Dim	Min	Max
A	1.3	1.8
b	1.25	1.75
c	0.1	0.3
D	2.25	2.75
E	4.15	4.65
H	4.5	5.5
L	0.7	1.3
All Dimensions in mm		

Marking Code :

SK520AF	SK530AF	SK540AF
SS52	SS53	SS54

SK550AF	SK560AF	SK580AF
SS55	SS56	SS58

SK5100AF		
S510		

Important Notice:

- All rights are reserved. Reproduction in whole or in part is prohibited without the prior written approval of CYStek.
- CYStek reserves the right to make changes to its products without notice.
- CYStek **semiconductor products are not warranted to be suitable for use in Life-Support Applications, or systems.**
- CYStek assumes no liability for any consequence of customer product design, infringement of patents, or application assistance.