



# 3.0Amp. Surface Mount Schottky Barrier Diodes SK32SB thru SK3BSB

## Features

- For surface mounted applications.
- For use in low voltage, high frequency inverters, free wheeling, and polarity protection applications.
- Plastic material used carries Underwriters Laboratory Flammability Classification 94V-0.
- Low leakage current.
- High surge capability.
- High temperature soldering: 250°C/10 seconds at terminals.
- Exceeds environmental standards of MIL-S-19500/228.

## Mechanical Data

- Case: Molded plastic, JEDEC DO-214AA/SMB.
- Terminals: Solder plated, solderable per MIL-STD-750 method 2026.
- Polarity: Indicated by cathode band.
- Mounting position: Any.
- Weight: 0.093 gram.

## Ordering Information

Device	Package	Shipping
SK3XSB - 0-T6-G	SMB (Pb-free lead plating and halogen-free package)	3000 pcs / Tape & Reel

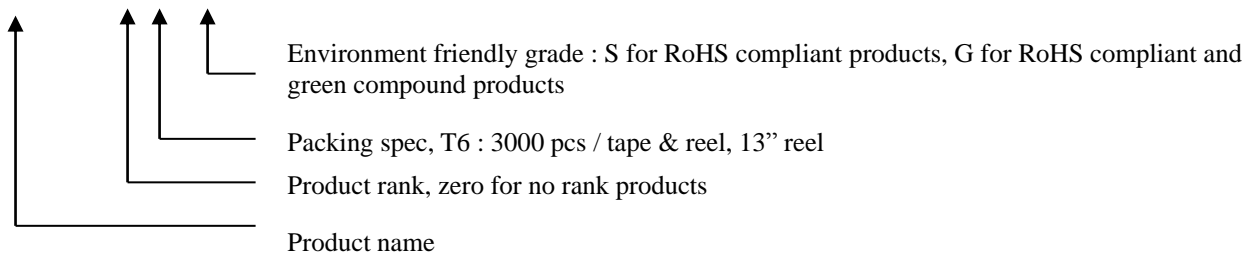

## Maximum Ratings and Electrical Characteristics

(Rating at 25°C ambient temperature unless otherwise specified. )

Parameter	Conditions	Symbols	SK32 SB	SK33 SB	SK34 SB	SK36 SB	SK3B SB	Units
Repetitive peak reverse voltage		$V_{RRM}$	20	30	40	60	100	V
Maximum RMS voltage		$V_{RMS}$	14	21	28	42	70	V
Maximum DC blocking voltage		$V_R$	20	30	40	60	100	V
Maximum instantaneous forward voltage	$I_F=3A$ (Note 1)	$V_F$	0.475	0.5	0.5	0.7	0.85	V
Maximum average forward rectified current		$I_O$	3					A
Peak forward surge current	8.3ms single half sine wave superimposed on rated load (JEDEC method)	$I_{FSM}$	100					A
Maximum DC reverse current	$V_R=V_{RRM}, T_A=25^{\circ}C$ (Note 1)	$I_R$	0.5					mA
	$V_R=V_{RRM}, T_A=125^{\circ}C$ (Note 1)		20					mA
Maximum thermal resistance, Junction to ambient (Note 2)		$R_{th,JA}$	40 (typ)					°C/W
Diode junction capacitance	f=1MHz and applied 4V reverse voltage	$C_J$	50 (typ)					pF
Storage temperature		$T_{stg}$	-65~+150					°C
Operating temperature		$T_J$	-55~+125			-55~+150		°C

 Notes : 1.Pulse test, pulse width=300  $\mu$  sec, 2% duty cycle

 2.Mounted on PCB with 0.2"×0.2"mm<sup>2</sup> (0.5mm×0.5mm) copper pad area.

## Recommended Footprint

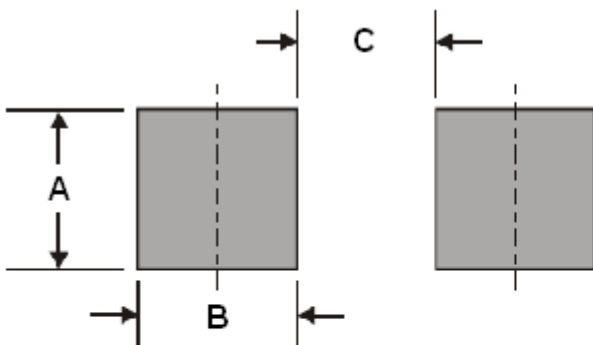

Dimensions in inches and (millimeter)

DIM	Inches	Millimeters
	Typ	Typ
A	0.142	3.60
B	0.059	1.50
C	0.118	3.00



### Characteristic Curves

Forward Current Derating Curve

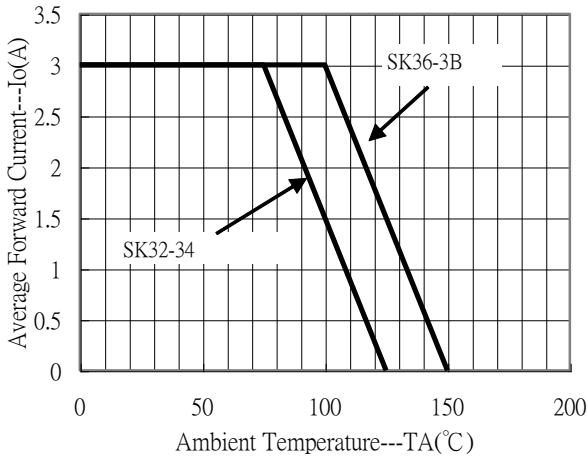

Maximum Non-Repetitive Surge Current

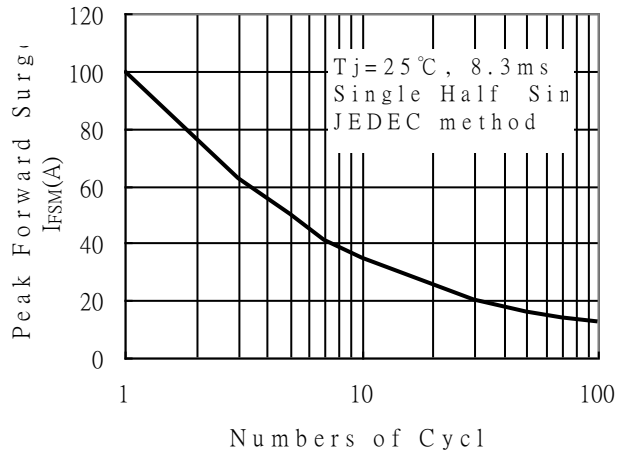

Forward Current vs Forward Voltage

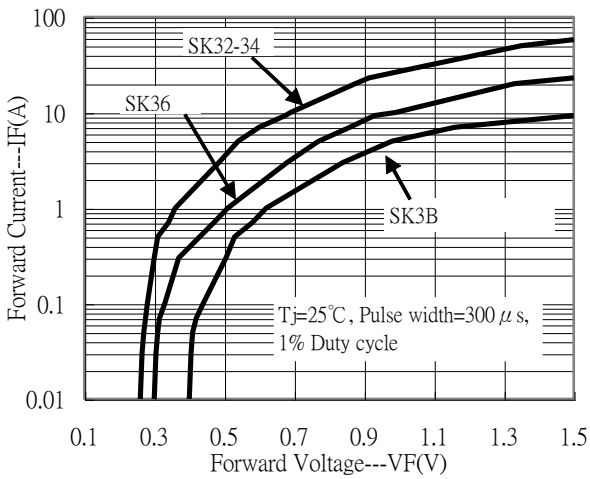

Junction Capacitance vs

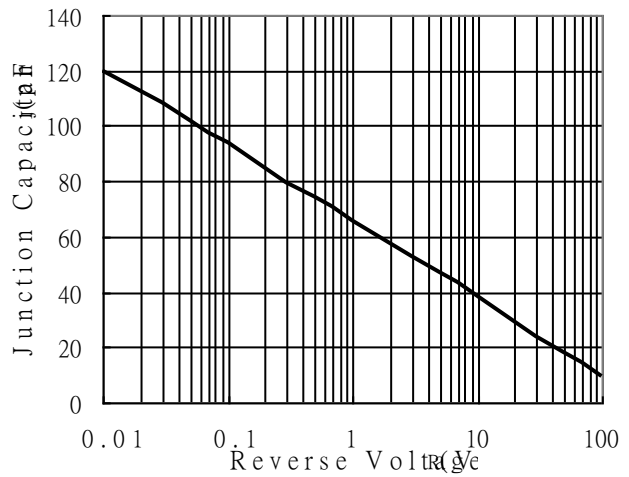

Reverse Leakage Current vs Reverse Voltage

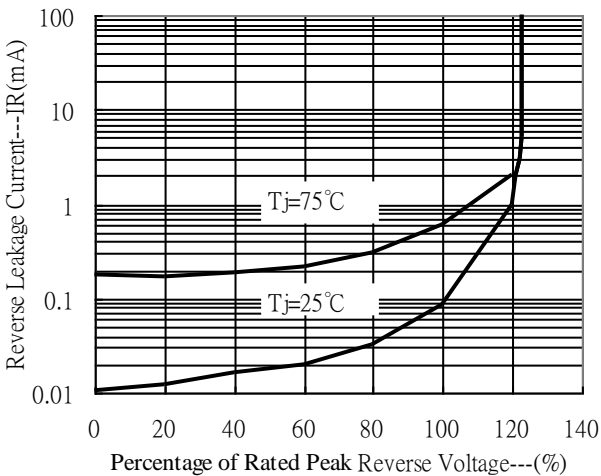

**Reel Dimension**

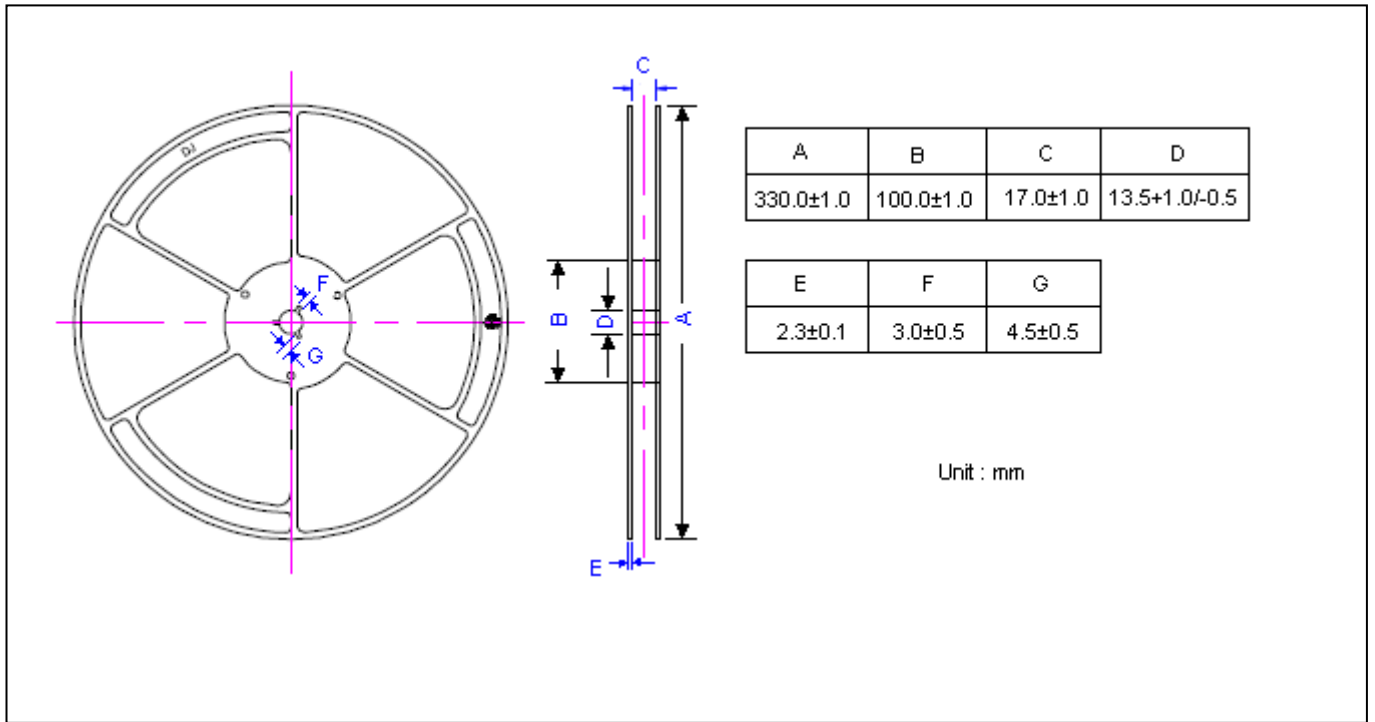

**Carrier Tape Dimension**

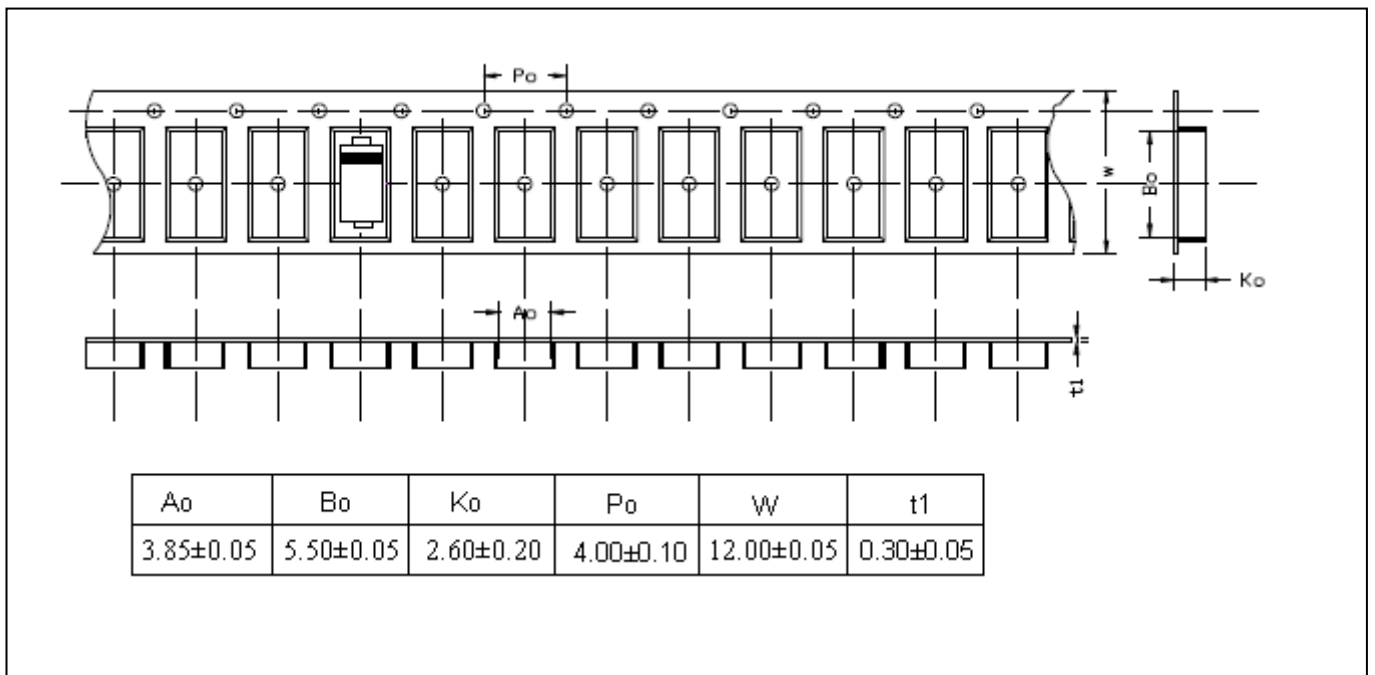

**Recommended wave soldering condition**

Product	Peak Temperature	Soldering Time
Pb-free devices	260 +0/-5 °C	5 +1/-1 seconds

**Recommended temperature profile for IR reflow**

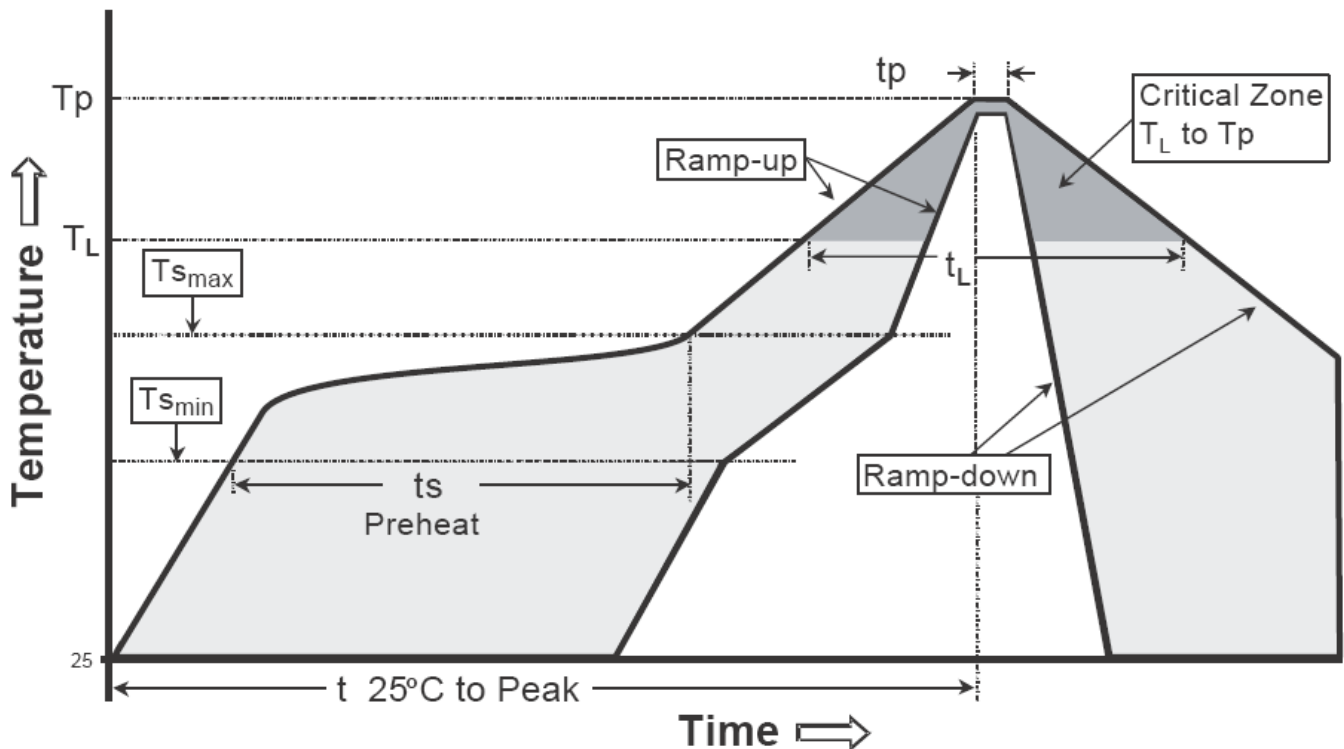

Profile feature	Sn-Pb eutectic Assembly	Pb-free Assembly
Average ramp-up rate (Tsmax to Tp)	3°C/second max.	3°C/second max.
Preheat		
-Temperature Min(Ts min)	100°C	150°C
-Temperature Max(Ts max)	150°C	200°C
-Time(ts min to ts max)	60-120 seconds	60-180 seconds
Time maintained above:		
-Temperature (TL)	183°C	217°C
- Time (tl)	60-150 seconds	60-150 seconds
Peak Temperature(Tp)	240 +0/-5 °C	260 +0/-5 °C
Time within 5°C of actual peak temperature(tp)	10-30 seconds	20-40 seconds
Ramp down rate	6°C/second max.	6°C/second max.
Time 25 °C to peak temperature	6 minutes max.	8 minutes max.

Note : All temperatures refer to topside of the package, measured on the package body surface.

**SMB/DO-214AA Dimension**

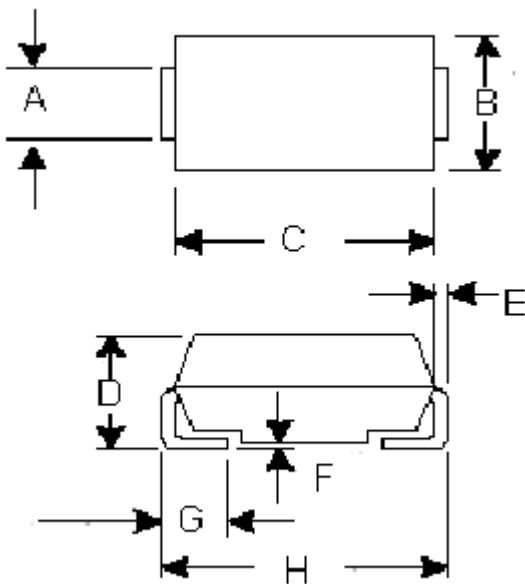

Marking Code :

SK32SB	SK33SB	SK34SB
SK32	SK33	SK34

SK36SB	SK3BSB	
SK36	SK3B	

SMB/DO-214AA Plastic  
 Surface Mounted Package  
 CYStek Package Code : SB

\*:Typical

DIM	Inches		Millimeters		DIM	Inches		Millimeters	
	Min.	Max.	Min.	Max.		Min.	Max.	Min.	Max.
A	0.075	0.083	1.91	2.11	E	0.006	0.012	0.15	0.31
B	0.130	0.155	3.30	3.94	F	0.002	0.008	0.05	0.20
C	0.154	0.185	3.90	4.70	G	0.035	0.056	0.90	1.41
D	0.078	0.103	1.99	2.61	H	0.200	0.220	5.08	5.59

Notes : 1.Controlling dimension : millimeters.  
 2.Maximum lead thickness includes lead finish thickness, and minimum lead thickness is the minimum thickness of base material.  
 3.If there is any question with packing specification or packing method, please contact your local CYStek sales office.

**Material :**

- Lead : Pure tin plated.
- Mold Compound : Epoxy resin family, flammability solid burning class:UL94V-0.

**Important Notice:**

- All rights are reserved. Reproduction in whole or in part is prohibited without the prior written approval of CYStek.
- CYStek reserves the right to make changes to its products without notice.
- CYStek **semiconductor products are not warranted to be suitable for use in Life-Support Applications, or systems.**
- CYStek assumes no liability for any consequence of customer product design, infringement of patents, or application assistance.