

**Surface Mount Transient Voltage Suppressors**  
**Peak Pulse Power 400W Breakdown Voltage 6.8 to 550V**

# P4SMA6.8A thru P4SMA550CA

## Features

- Low profile package with built-in strain relief for surface mounted applications
- Plastic package has UL flammability classification 94V-0
- Ideal for ESD protection of data line in accordance with IEC1000-4-2 (IEC801-2)
- Ideal for EFT protection of data line in accordance with IEC1000-4-4 (IEC801-4)
- Very-fast response time
- Optimized for LAN protection applications
- Low incremental surge resistance, excellent clamping capability
- Glass passivated junction
- High temperature soldering guaranteed: 250°C/10seconds at terminals
- 400W peak pulse power capability with a 10/1000µs waveform, repetition rate (duty cycle) : 0.01% (300W above 91V)

## Outline



## Mechanical Data

- Case : JEDEC DO-214AC(SMA) molded plastic body
- Terminals: Pure tin plated, solderable per MIL-STD-750 method 2026
- Polarity: For uni-directional types, the band denotes the cathode, which is positive with respect to the anode under normal TVS operation
- Mounting position : Any
- Weight: 0.002 oz., 0.064 gram

## Devices for bidirectional applications

For bi-directional devices, use suffix CA (e.g. P4SMA10CA). Electrical characteristics apply in both directions.

## Maximum Ratings and Characteristics (T<sub>A</sub>=25°C, unless otherwise noted)

Parameter	Symbol	Value	Unit
Peak pulse power dissipation with a 10/1000µs waveform (Fig. 1)	PPPM	Minimum 400 (Note 1, 2)	W
Peak pulse current with a 10/1000µs waveform (Fig. 3)	IPPM	See next table (Note 1)	A
Power dissipation on infinite heatsink, T <sub>A</sub> =50°C	P <sub>M(AV)</sub>	1	W
Peak forward surge current, 8.3ms single half sine wave uni-directional only (Note 2)	I <sub>FSM</sub>	40	A
Typical thermal resistance, junction-to-leads	R <sub>θJL</sub>	30	°C/W
Typical thermal resistance, junction-to-ambient (Note 3)	R <sub>θJA</sub>	120	°C/W
Operating junction and storage temperature range	T <sub>J</sub> ;T <sub>STG</sub>	-55 ~ +150	°C

Notes: 1.Non-repetitive current pulse, per Fig. 3 and derated above T<sub>A</sub>=25°C per Fig. 2. Rating is 300W above 91V.

2.Mounted on 0.2"×0.2" (5mm×5mm) copper pads to each terminal

3.Mounted on minimum recommended pad layout



**Electrical Characteristics** Ratings at 25°C ambient temperature, unless otherwise noted.

V<sub>F</sub>=3.5V at I<sub>F</sub>=25A (uni-directional only)

Device	Device Marking Code		Breakdown Voltage V <sub>(BR)</sub> (V) <sup>1</sup>		Test current at I <sub>T</sub> (mA)	Standoff voltage V <sub>WM</sub> (V)	Maximum reverse leakage at V <sub>WM</sub> I <sub>D</sub> <sup>3</sup> (μA)	Maximum peak pulse Current I <sub>PPM</sub> <sup>2</sup> (A)	Maximum clamping voltage at I <sub>PPM</sub> V <sub>C</sub> (V)	Maximum temperature coefficient of V <sub>(BR)</sub> (%/°C)
	UNI	BI	Min	Max						
P4SMA6.8A	6V8A	6V8C	6.45	7.14	10	5.80	1000	57.1	10.5	0.057
P4SMA7.5A	7V5A	7V5C	7.13	7.88	10	6.40	500	53.1	11.3	0.061
P4SMA8.2A	8V2A	8V2C	7.79	8.61	10	7.02	200	49.6	12.1	0.065
P4SMA9.1A	9V1A	9V1C	8.65	9.55	1.0	7.78	50	44.8	13.4	0.068
P4SMA 10A	10A	10C	9.50	10.5	1.0	8.55	10	41.4	14.5	0.073
P4SMA 11A	11A	11C	10.5	11.6	1.0	9.40	5.0	38.5	15.6	0.075
P4SMA 12A	12A	12C	11.4	12.6	1.0	10.2	5.0	35.9	16.7	0.078
P4SMA 13A	13A	13C	12.4	13.7	1.0	11.1	5.0	33.0	18.2	0.081
P4SMA 15A	15A	15C	14.3	15.8	1.0	12.8	1.0	28.3	21.2	0.084
P4SMA 16A	16A	16C	15.2	16.8	1.0	13.6	1.0	26.7	22.5	0.086
P4SMA 18A	18A	18C	17.1	18.9	1.0	15.3	1.0	23.8	25.2	0.088
P4SMA 20A	20A	20C	19.0	21.0	1.0	17.1	1.0	21.7	27.7	0.090
P4SMA 22A	22A	22C	20.9	23.1	1.0	18.8	1.0	19.6	30.6	0.092
P4SMA 24A	24A	24C	22.8	25.2	1.0	20.5	1.0	18.1	33.2	0.094
P4SMA 27A	27A	27C	25.7	28.4	1.0	23.1	1.0	16.0	37.5	0.096
P4SMA 30A	30A	30C	28.5	31.5	1.0	25.6	1.0	14.5	41.4	0.097
P4SMA 33A	33A	33C	31.4	34.7	1.0	28.2	1.0	13.1	45.7	0.098
P4SMA 36A	36A	36C	34.2	37.8	1.0	30.8	1.0	12.0	49.9	0.099
P4SMA 39A	39A	39C	37.1	41.0	1.0	33.3	1.0	11.1	53.9	0.100
P4SMA 43A	43A	43C	40.9	45.2	1.0	36.8	1.0	10.1	59.3	0.101
P4SMA 47A	47A	47C	44.7	49.4	1.0	40.2	1.0	9.3	64.8	0.101
P4SMA 51A	51A	51C	48.5	53.6	1.0	43.6	1.0	8.6	70.1	0.102
P4SMA 56A	56A	56C	53.2	58.8	1.0	47.8	1.0	7.8	77.0	0.103
P4SMA 62A	62A	62C	58.9	65.1	1.0	53.0	1.0	7.1	85.0	0.104
P4SMA 68A	68A	68C	64.6	71.4	1.0	58.1	1.0	6.5	92.0	0.104
P4SMA 75A	75A	75C	71.3	78.8	1.0	64.1	1.0	5.8	103	0.105
P4SMA 82A	82A	82C	77.9	86.1	1.0	70.1	1.0	5.3	113	0.105
P4SMA 91A	91A	91C	86.5	95.5	1.0	77.8	1.0	4.8	125	0.106
P4SMA 100A	100A	100C	95.0	105	1.0	85.5	1.0	4.4	137	0.106
P4SMA 110A	110A	110C	105	116	1.0	94.0	1.0	3.9	152	0.107
P4SMA 120A	120A	120C	114	126	1.0	102	1.0	3.6	165	0.107
P4SMA 130A	130A	130C	124	137	1.0	111	1.0	3.4	179	0.107
P4SMA 150A	150A	150C	143	158	1.0	128	1.0	2.9	207	0.108
P4SMA 160A	160A	160C	152	168	1.0	136	1.0	2.7	219	0.108
P4SMA 170A	170A	170C	162	179	1.0	145	1.0	2.6	234	0.108
P4SMA 180A	180A	180C	171	189	1.0	154	1.0	2.4	246	0.108
P4SMA 200A	200A	200C	190	210	1.0	171	1.0	2.2	274	0.108

## Electrical Characteristics(Cont.)

Device	Device Marking Code		Breakdown Voltage $V_{(BR)}$ (V) <sup>1</sup>		Test current at $I_T$ (mA)	Standoff voltage $V_{WM}$ (V)	Maximum reverse leakage at $V_{WM}$ $I_D^3$ ( $\mu A$ )	Maximum peak pulse Current $I_{PPM}^2$ (A)	Maximum clamping voltage at $I_{PPM}$ $V_C$ (V)	Maximum temperature coefficient of $V_{(BR)}$ ( $\%/^{\circ}C$ )
	UNI	BI	Min	Max						
P4SMA 220A	220A	220C	209	231	1.0	185	1.0	1.8	328	0.108
P4SMA 250A	250A	250C	237	263	1.0	214	1.0	1.7	344	0.108
P4SMA 300A	300A	300C	285	315	1.0	256	1.0	1.4	414	0.108
P4SMA 350A	350A	350C	333	368	1.0	300	1.0	1.2	482	0.108
P4SMA 400A	400A	400C	380	420	1.0	342	1.0	1.1	548	0.108
P4SMA 440A	440A	440C	418	462	1.0	376	1.0	1.0	602	0.108
P4SMA 480A	480A	480C	456	504	1.0	408	1.0	0.9	658	0.108
P4SMA 510A	510A	510C	485	535	1.0	434	1.0	0.9	698	0.108
P4SMA 530A	530A	530C	503.5	556.5	1.0	450	1.0	0.8	725	0.108
P4SMA 540A	540A	540C	513	567	1.0	459	1.0	0.8	740	0.108
P4SMA 550A	550A	550C	522.5	577.5	1.0	495	1.0	0.8	760	0.108

Note: 1.  $V_{(BR)}$  measured after  $I_T$  applied for 300 $\mu s$ ,  $I_T$ =square wave pulse or equivalent

2. Surge current waveform per Fig. 3 and derate per Fig.2

3. For bidirectional types with  $V_{WM}$  of 10 volts and less, the  $I_D$  limit is doubled

4. All terms and symbols are consistent with ANSI/IEEE C62.35

## Ordering Information

Device	Package	Shipping
P4MAXXXA-0-T4-G	SMA	7500 pcs / Tape & Reel
P4SMAXXXCA-0-T4-G	(Pb-free lead plating and halogen-free package)	



## Recommended soldering footprint

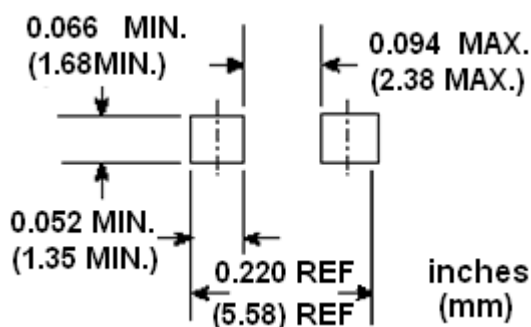

## Characteristic Curves

**Fig. 1 – Peak Pulse Power Rating Curve**

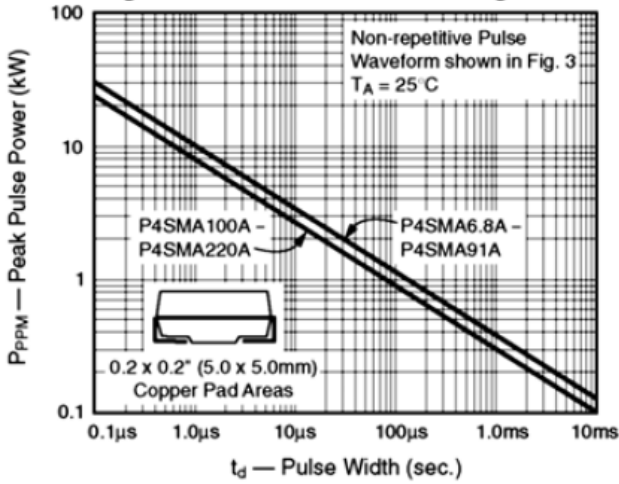

**Fig. 2 – Pulse Derating Curve**

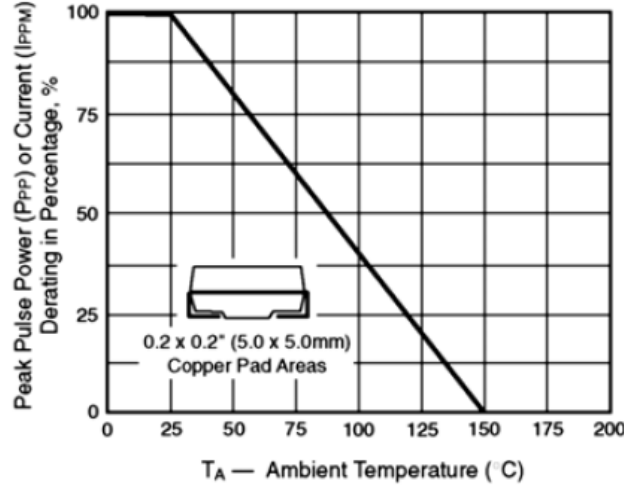

**Fig. 3 – Pulse Waveform**

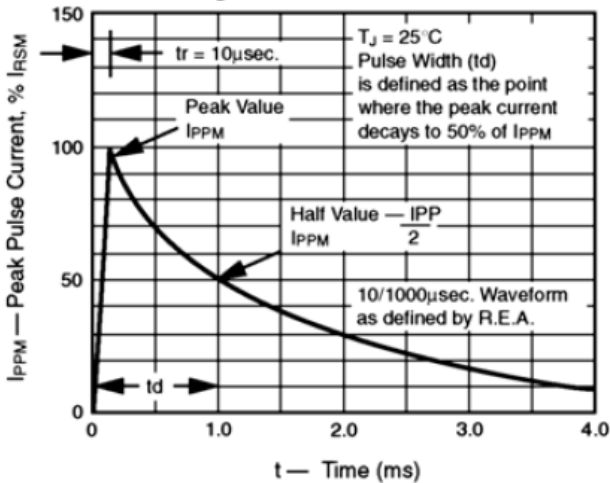

**Fig. 4 – Typical Junction Capacitance**

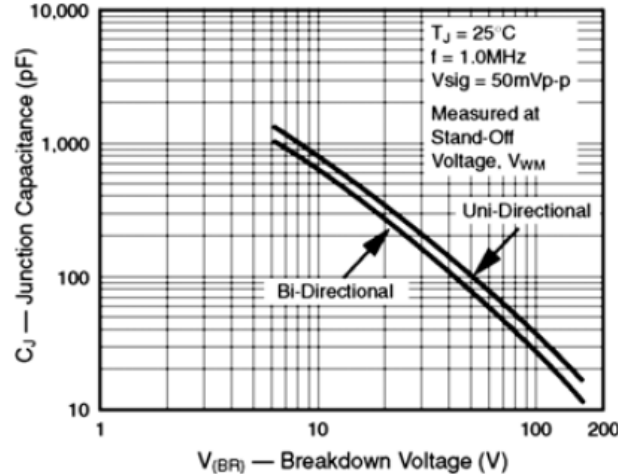

**Fig. 5 – Typical Transient Thermal Impedance**

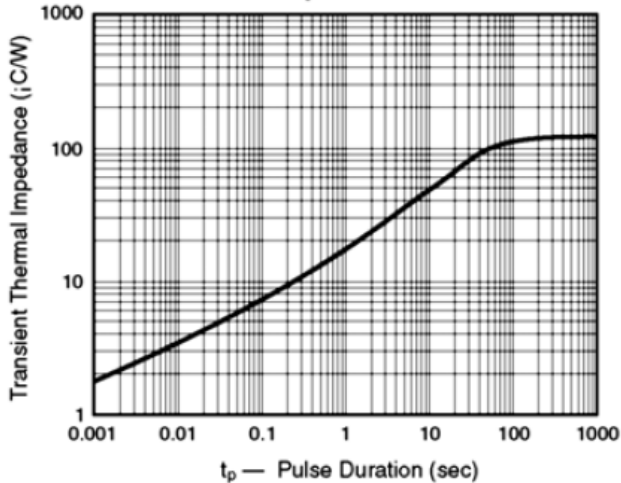

**Fig. 6 - Maximum Non-Repetitive Forward Surge Current Uni-Directional Only**

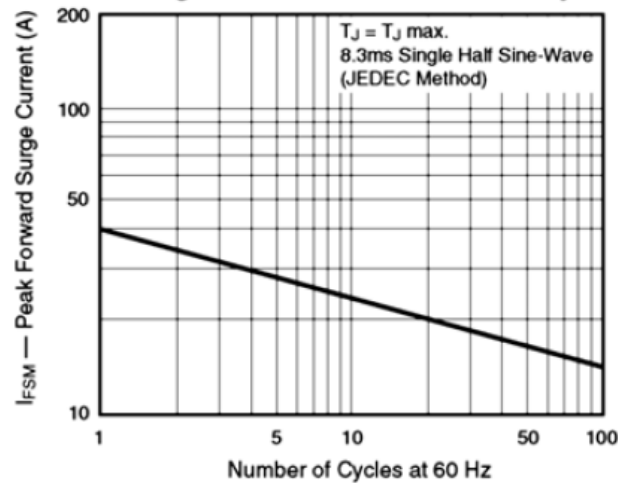



**Recommended wave soldering condition**

Product	Peak Temperature	Soldering Time
Pb-free devices	260 +0/-5 °C	5 +1/-1 seconds

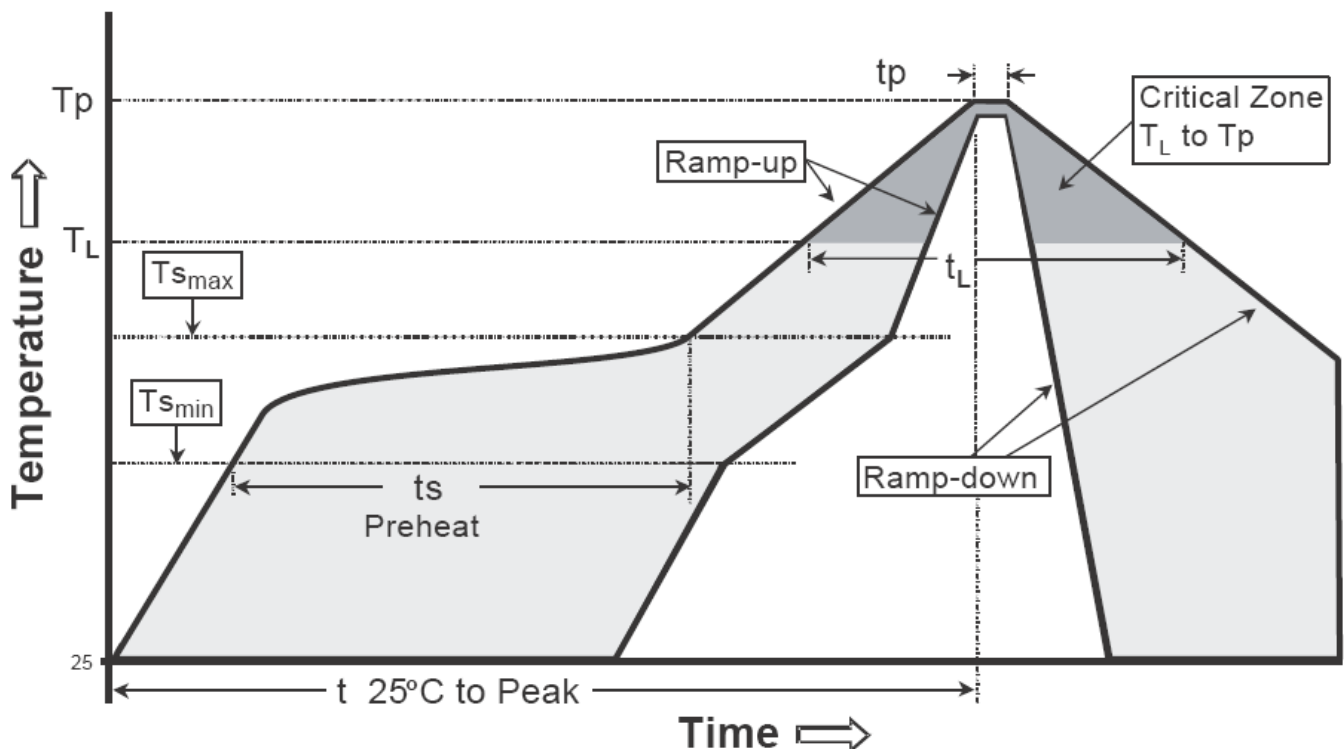
**Recommended temperature profile for IR reflow**

Profile feature	Sn-Pb eutectic Assembly	Pb-free Assembly
Average ramp-up rate (Tsmax to Tp)	3°C/second max.	3°C/second max.
Preheat		
-Temperature Min(Ts min)	100°C	150°C
-Temperature Max(Ts max)	150°C	200°C
-Time(ts min to ts max)	60-120 seconds	60-180 seconds
Time maintained above:		
-Temperature (TL)	183°C	217°C
- Time (tL)	60-150 seconds	60-150 seconds
Peak Temperature(Tp)	240 +0/-5 °C	260 +0/-5 °C
Time within 5°C of actual peak temperature(tp)	10-30 seconds	20-40 seconds
Ramp down rate	6°C/second max.	6°C/second max.
Time 25 °C to peak temperature	6 minutes max.	8 minutes max.

Note : All temperatures refer to topside of the package, measured on the package body surface.



**DO-214AC/SMA Dimension**

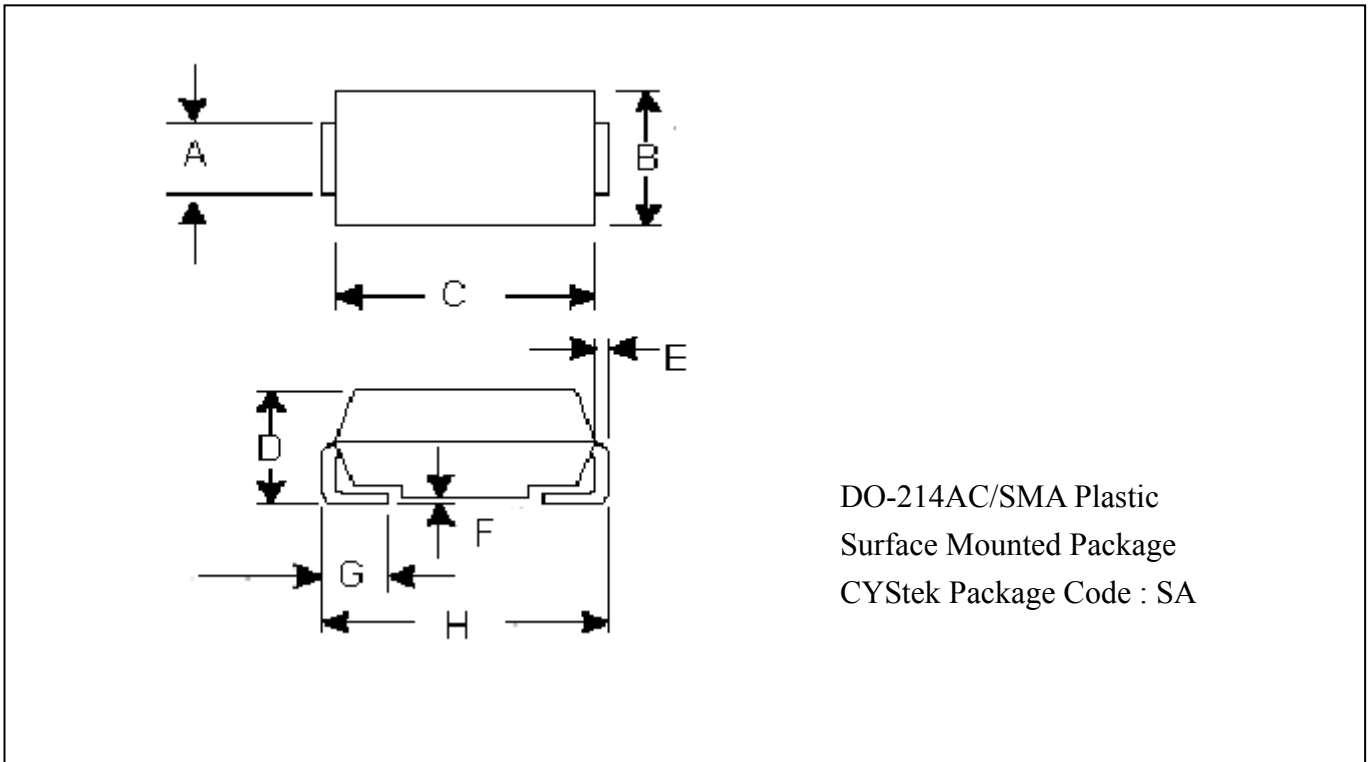

\*:Typical

DIM	Inches		Millimeters		DIM	Inches		Millimeters	
	Min.	Max.	Min.	Max.		Min.	Max.	Min.	Max.
A	0.050	0.064	1.27	1.63	E	0.006	0.012	0.15	0.31
B	0.095	0.104	2.40	2.65	F	0.004	0.008	0.10	0.20
C	0.157	0.181	4.00	4.60	G	0.031	0.059	0.80	1.50
D	0.075	0.089	1.90	2.25	H	0.189	0.205	4.80	5.20

Notes : 1.Controlling dimension : millimeters.  
 2.Maximum lead thickness includes lead finish thickness, and minimum lead thickness is the minimum thickness of base material.  
 3.If there is any question with packing specification or packing method, please contact your local CYStek sales office.

**Material :**

- Lead : Pure tin plated
- Mold Compound : Epoxy resin family, flammability solid burning class:UL94V-0

**Important Notice:**

- All rights are reserved. Reproduction in whole or in part is prohibited without the prior written approval of CYStek.
- CYStek reserves the right to make changes to its products without notice.
- CYStek **semiconductor products are not warranted to be suitable for use in Life-Support Applications, or systems.**
- CYStek assumes no liability for any consequence of customer product design, infringement of patents, or application assistance.