

Dual N-Channel Enhancement Mode MOSFET

MTS2072G6

	Tr1(N-CH)	Tr2(N-CH)
BV_{DSS}	60V	30V
I_D	0.53A($V_{GS}=10V$)	5.6A($V_{GS}=10V$)
$R_{DSON(TYP.)}$	1.2 Ω ($V_{GS}=10V$)	16.6m Ω ($V_{GS}=10V$)
	1.6 Ω ($V_{GS}=4.5V$)	24.7m Ω ($V_{GS}=4.5V$)

Description

The MTS2072G6 consists of two different N-channel enhancement-mode MOSFETs in a single TSOP-6 package, providing the designer with the best combination of fast switching, ruggedized device design, low on-resistance and cost-effectiveness.

The TSOP-6 package is universally preferred for all commercial-industrial surface mount applications.

Features

- Simple drive requirement
- Low gate charge
- Low on-resistance
- Fast switching speed
- Pb-free lead plating and halogen-free package

Equivalent Circuit

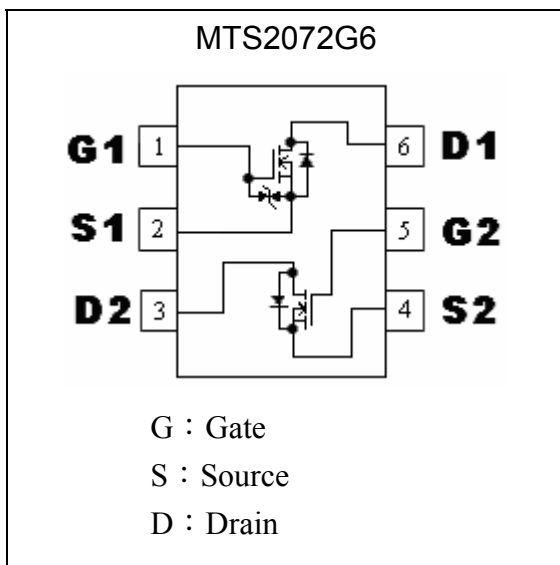

Outline

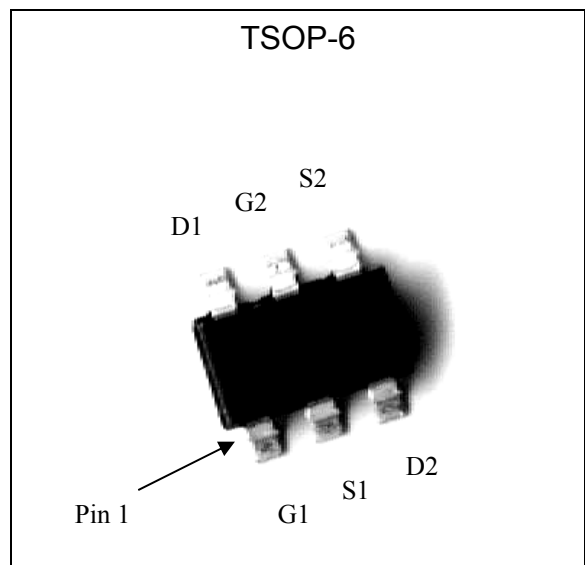



Absolute Maximum Ratings (Ta=25°C)

Parameter	Symbol	Limits		Unit
		N-channel	N-channel	
Drain-Source Breakdown Voltage	BV _{DSS}	60	30	V
Gate-Source Voltage	V _{GS}	±20	±20	V
Continuous Drain Current @T _A =25 °C, V _{GS} =10V (Note 1)	I _D	0.53	5.6	A
Continuous Drain Current @T _A =70 °C, V _{GS} =10V (Note 1)	I _D	0.42	4.5	A
Pulsed Drain Current (Note 2)	I _{DM}	1	20	A
Total Power Dissipation (Note 1)	P _d	1.14		W
Linear Derating Factor		0.01		W / °C
Operating Junction and Storage Temperature	T _j , T _{stg}	-55~+150		°C
Thermal Resistance, Junction-to-Ambient (Note 1)	R _{th,ja}	110		°C/W

Note : 1.Surface mounted on 1 in² copper pad of FR-4 board, t≤5 sec; 180°C/W when mounted on minimum copper pad.
 2.Pulse width limited by maximum junction temperature.

Tr 1, N-Channel Electrical Characteristics (Tj=25°C, unless otherwise specified)

Symbol	Min.	Typ.	Max.	Unit	Test Conditions
Static					
BV _{DSS}	60	-	-	V	V _{GS} =0, I _D =250μA
V _{GS(th)}	0.9	1.5	2.4		V _{DS} =V _{GS} , I _D =250μA
I _{GSS}	-	-	±10	μA	V _{GS} =±20V, V _{DS} =0
I _{DSS}	-	-	1		V _{DS} =60V, V _{GS} =0
	-	-	10		V _{DS} =48V, V _{GS} =0, T _j =70°C
*R _{DS(ON)}	-	1.2	2.5	Ω	I _D =500mA, V _{GS} =10V
	-	1.6	3		I _D =100mA, V _{GS} =4.5V
*G _{FS}	100	215	-	mS	V _{DS} =10V, I _D =100mA
Dynamic					
C _{iSS}	-	31	-	pF	V _{DS} =10V, V _{GS} =0, f=1MHz
C _{oSS}	-	6	-		
C _{rSS}	-	4.1	-		
*t _{d(ON)}	-	2.5	-	ns	V _{DS} =30V, I _D =100mA, V _{GS} =10V, R _G =25 Ω
*t _r	-	6.3	-		
*t _{d(OFF)}	-	6	-		
*t _f	-	4.4	-		
*Q _g	-	0.9	-	nC	V _{DS} =30V, I _D =0.53A, V _{GS} =10V
*Q _{gs}	-	0.1	-		
*Q _{gd}	-	0.3	-		
Source-Drain Diode					
*I _S	-	-	0.53	A	
*I _{SM}	-	-	1		
*V _{SD}	-	0.8	1.2	V	V _{GS} =0V, I _S =100mA

*Pulse Test : Pulse Width ≤300μs, Duty Cycle≤2%



Tr 2, N-Channel Electrical Characteristics (Tj=25°C, unless otherwise specified)

Symbol	Min.	Typ.	Max.	Unit	Test Conditions
Static					
BV _{DSS}	30	-	-	V	V _{GS} =0, I _D =250μA
V _{GS(th)}	1	1.6	2.5	V	V _{DS} =V _{GS} , I _D =250μA
I _{GSS}	-	-	±100	nA	V _{GS} =±20V, V _{DS} =0
I _{DSS}	-	-	1	μA	V _{DS} =24V, V _{GS} =0
	-	-	25	μA	V _{DS} =24V, V _{GS} =0, Tj=70°C
*R _{DS(ON)}	-	16.6	25	mΩ	I _D =5A, V _{GS} =10V
	-	24.7	35		I _D =3A, V _{GS} =4.5V
*G _{FS}	-	6	-	S	V _{DS} =5V, I _D =4A
Dynamic					
C _{iss}	-	718	-	pF	V _{DS} =15V, V _{GS} =0, f=1MHz
C _{oss}	-	78	-		
C _{rss}	-	69	-		
*t _{d(ON)}	-	7.4	-	ns	V _{DS} =15V, I _D =1A, V _{GS} =10V, R _G =6Ω
*t _r	-	19	-		
*t _{d(OFF)}	-	35	-		
*t _f	-	13	-		
*Q _g	-	10	-	nC	V _{DS} =15V, I _D =5.6A, V _{GS} =10V
*Q _{gs}	-	2.5	-		
*Q _{gd}	-	3.1	-		
Source-Drain Diode					
*I _S	-	-	5	A	
*I _{SM}	-	-	20		
*V _{SD}	-	0.82	1.2	V	V _{GS} =0V, I _S =5A

*Pulse Test : Pulse Width ≤300μs, Duty Cycle≤2%

Ordering Information

Device	Package	Shipping
MTS2072G6-0-T1-G	TSOP-6 (Pb-free lead plating and halogen-free package)	3000 pcs / Tape & Reel

N-channel Typical Characteristics, Tr 1

Typical Output Characteristics

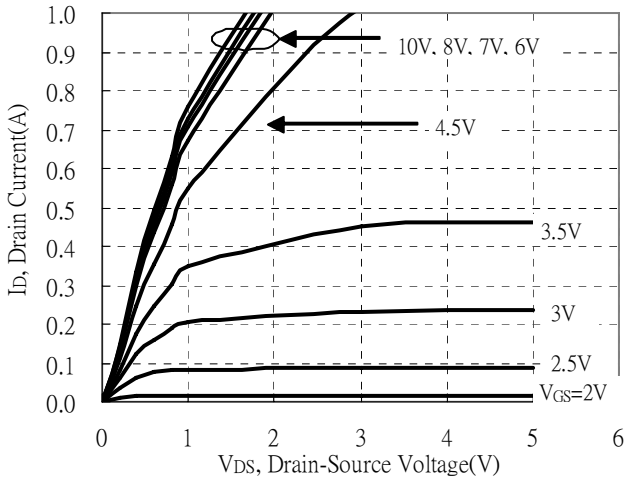

Brekdown Voltage vs Ambient Temperature

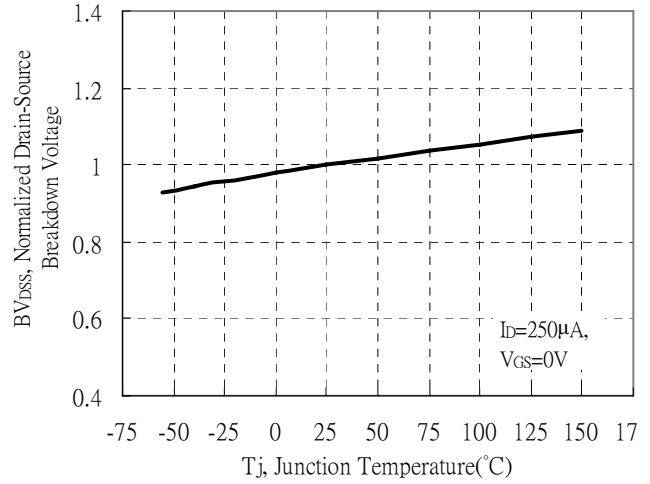

Static Drain-Source On-State resistance vs Drain Current

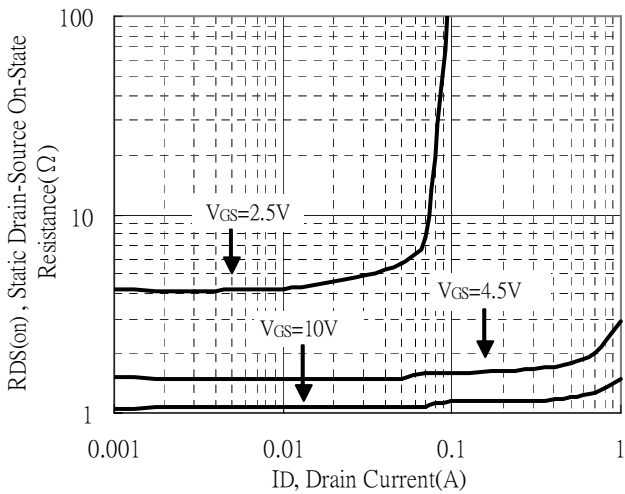

Reverse Drain Current vs Source-Drain Voltage

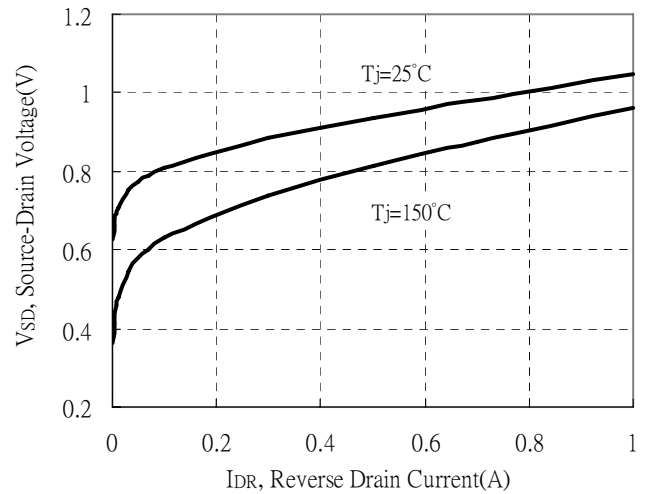

Static Drain-Source On-State Resistance vs Gate-Source Voltage

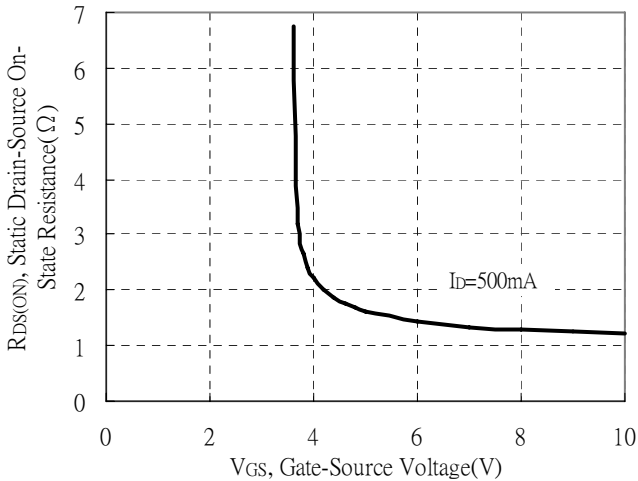

Drain-Source On-State Resistance vs Junction Temperature

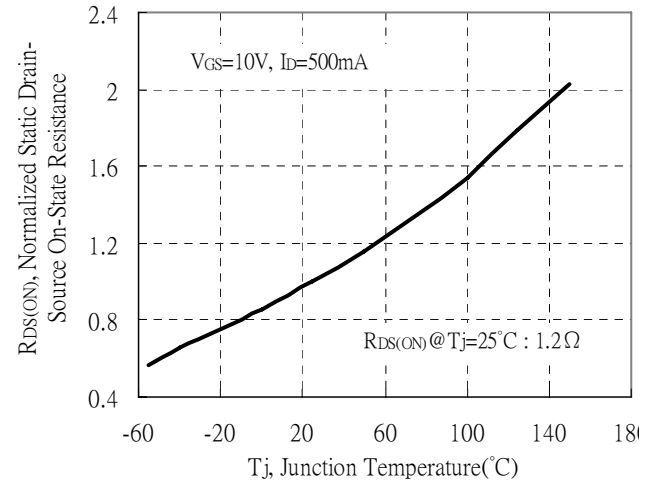



N-channel Typical Characteristics, Tr 1(Cont.)

Capacitance vs Drain-to-Source Voltage

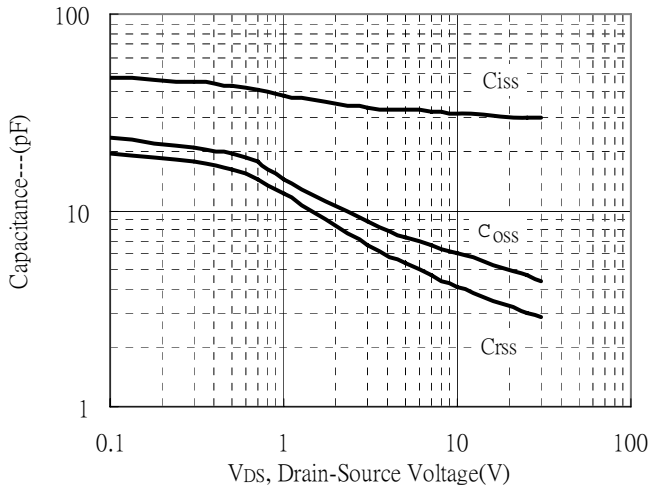

Threshold Voltage vs Junction Temperature

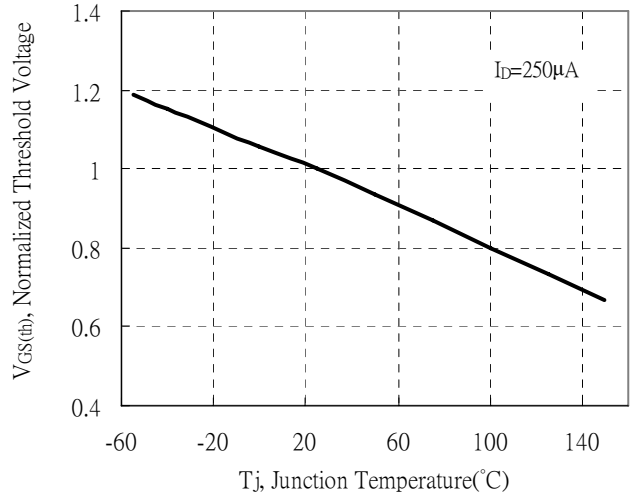

Maximum Drain Current vs Junction Temperature

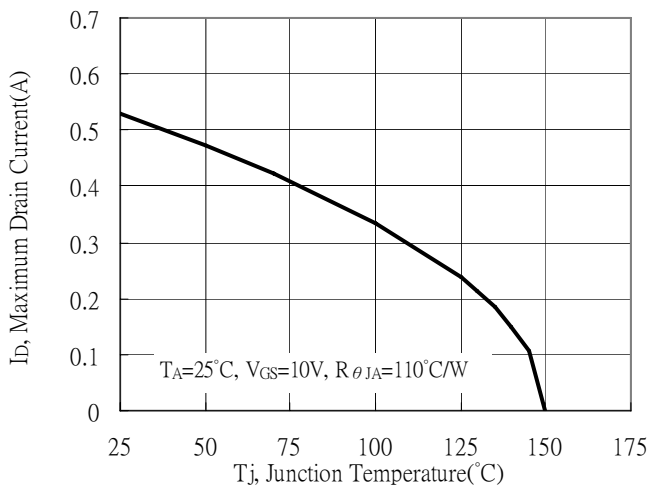

Typical Transfer Characteristics

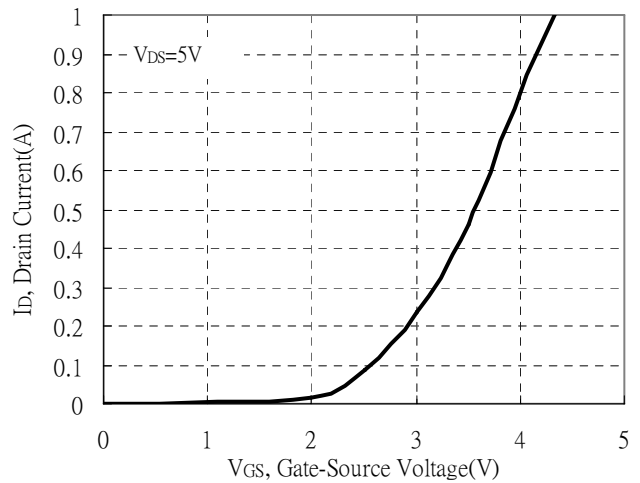

Gate Charge Characteristics

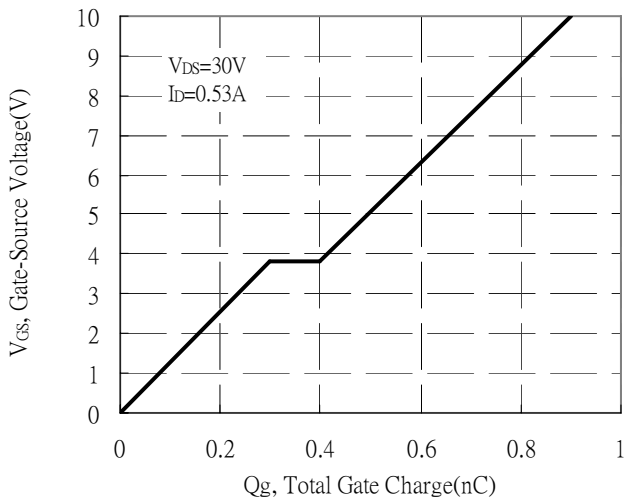

Forward Transfer Admittance vs Drain Current

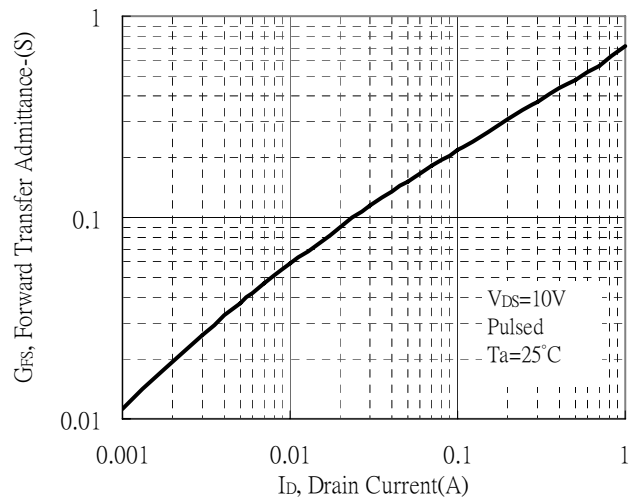



N-channel Typical Characteristics, Tr 1(Cont.)

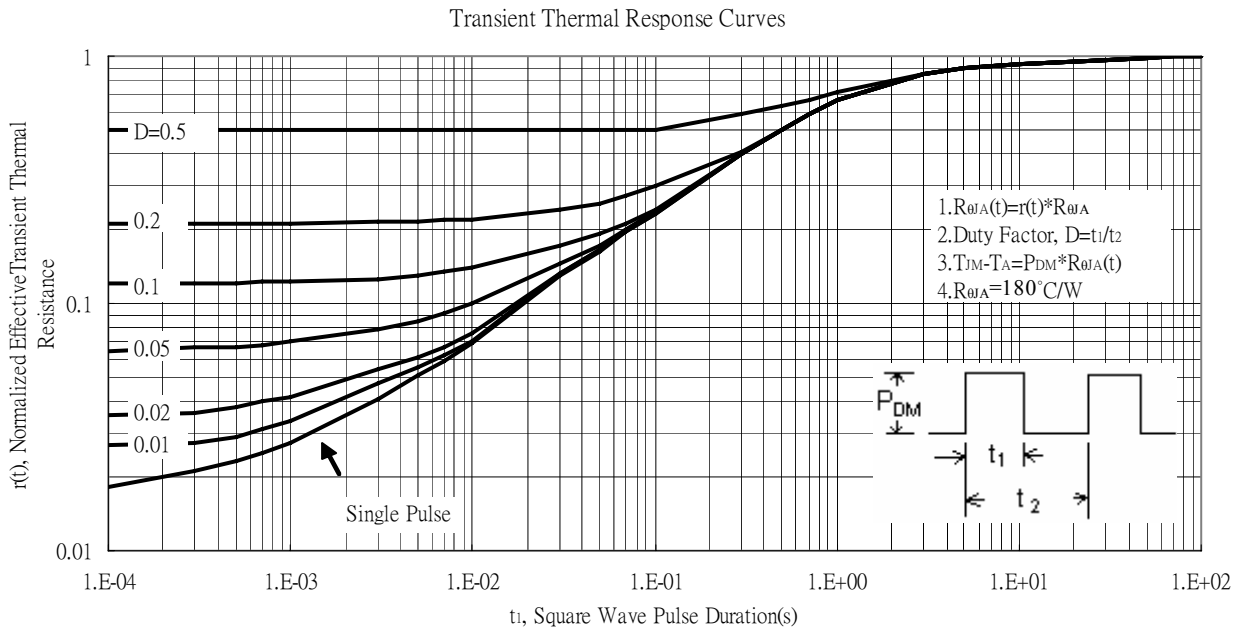
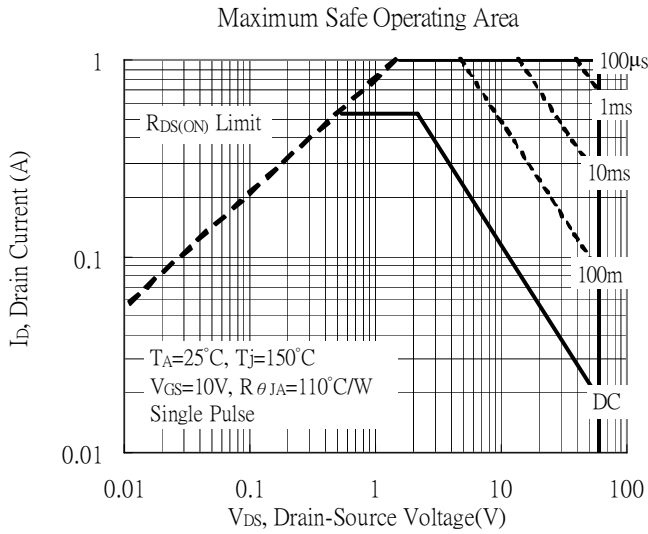



N-channel Typical Characteristics, Tr 2

Typical Output Characteristics

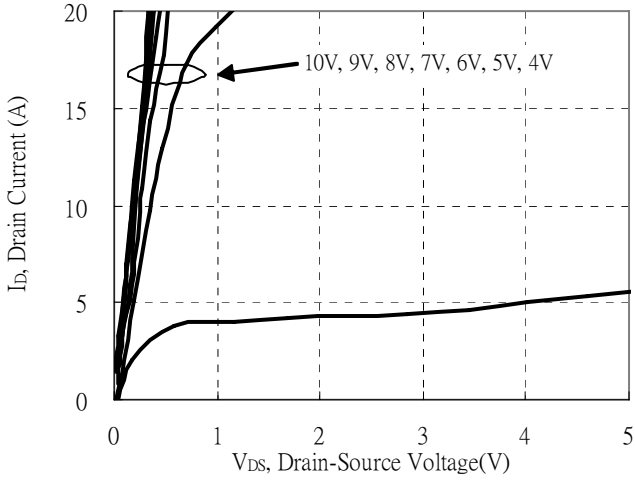

Brekdown Voltage vs Ambient Temperature

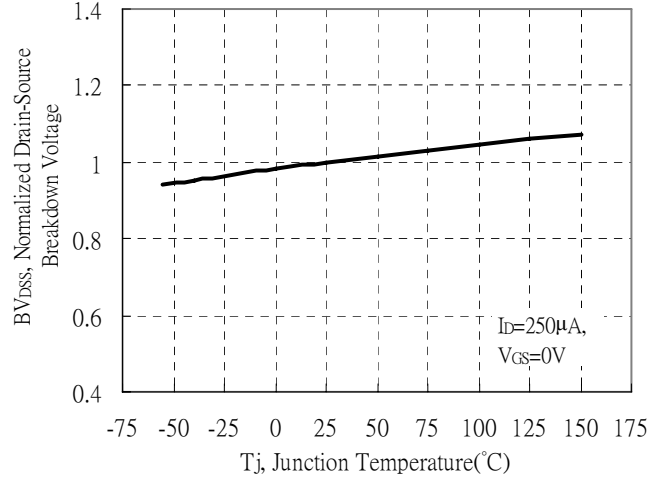

Static Drain-Source On-State resistance vs Drain Current

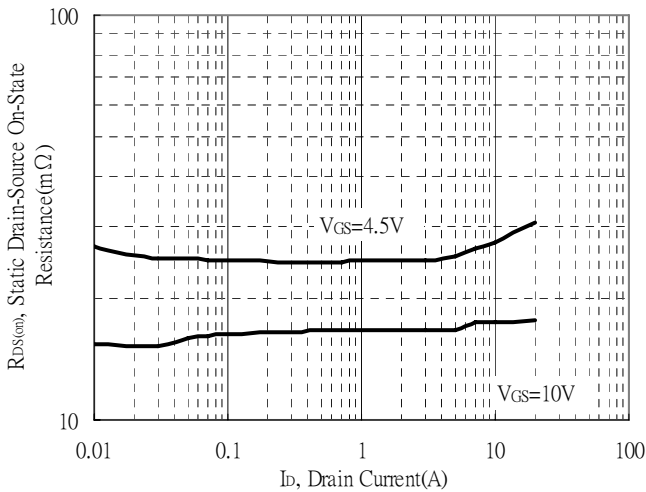

Reverse Drain Current vs Source-Drain Voltage

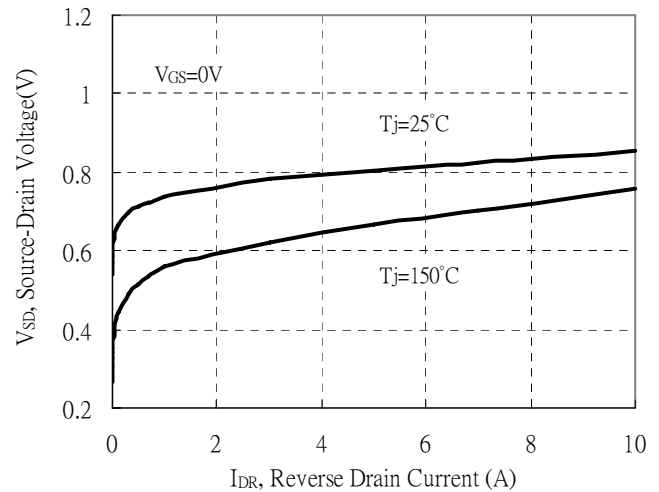

Static Drain-Source On-State Resistance vs Gate-Source Voltage

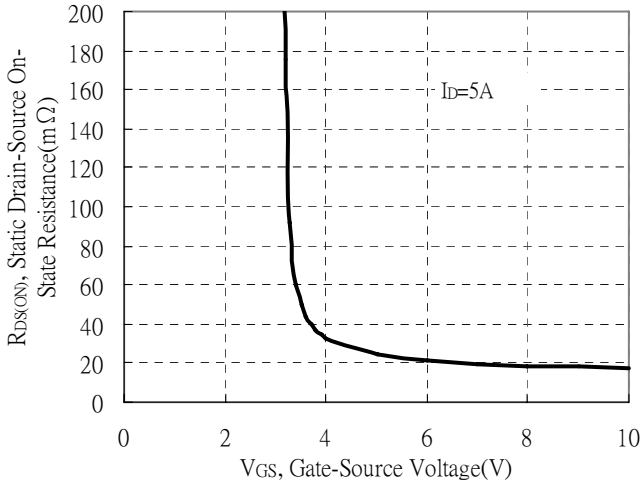

Drain-Source On-State Resistance vs Junction Temperature

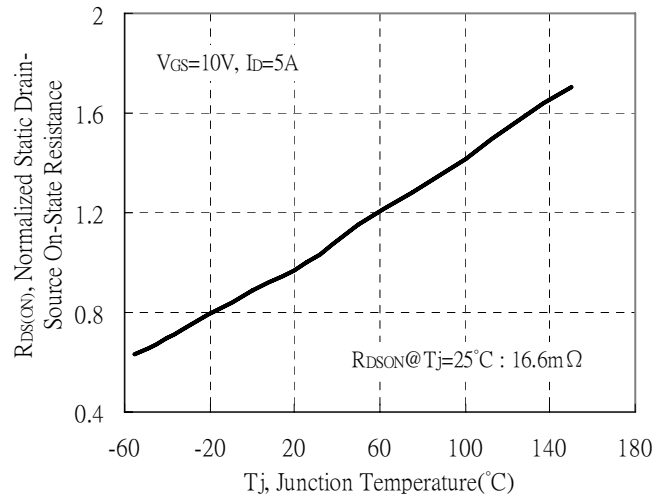

N-channel Typical Characteristics, Tr 2(Cont.)

Capacitance vs Drain-to-Source Voltage

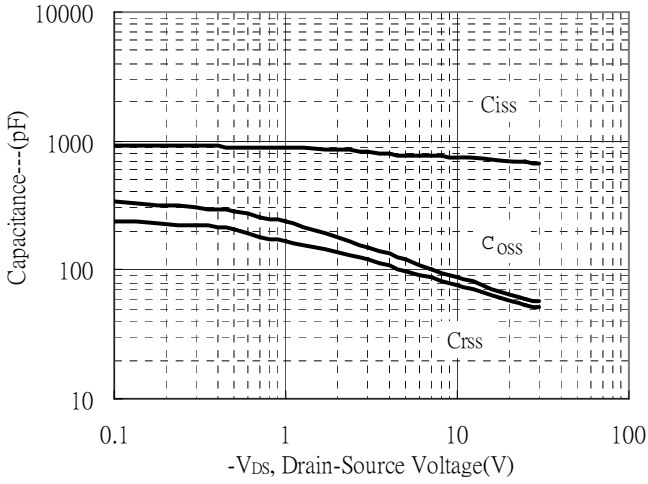

Threshold Voltage vs Junction Temperature

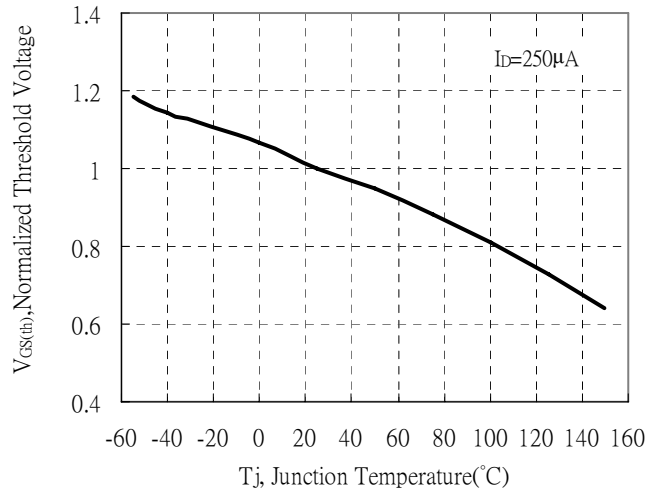

Forward Transfer Admittance vs Drain Current

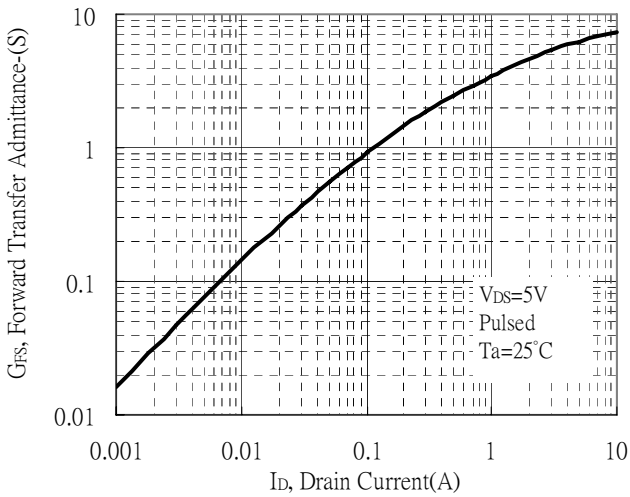

Gate Charge Characteristics

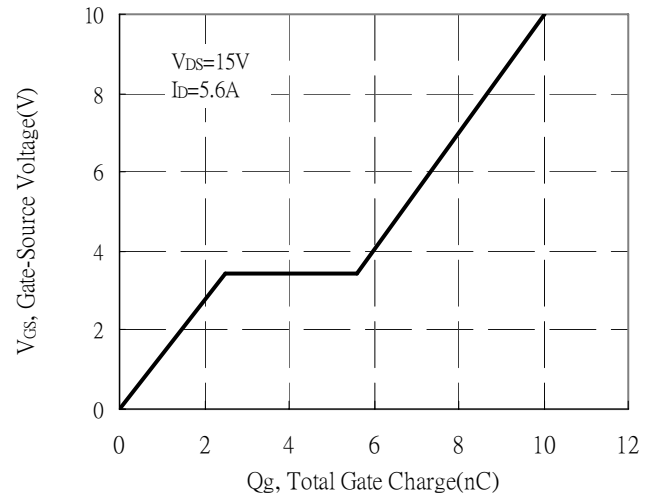

Typical Transfer Characteristics

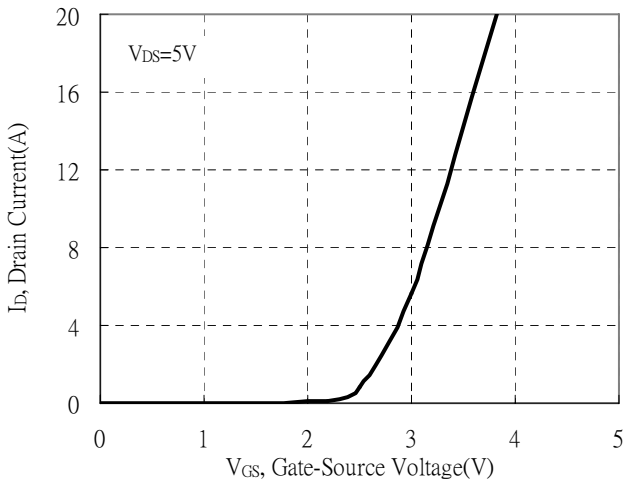

Maximum Drain Current vs Junction Temperature

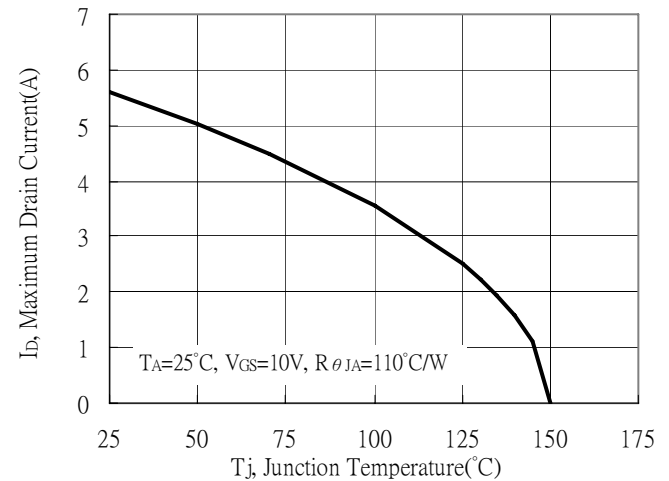

N-channel Typical Characteristics, Tr 2(Cont.)

Maximum Safe Operating Area

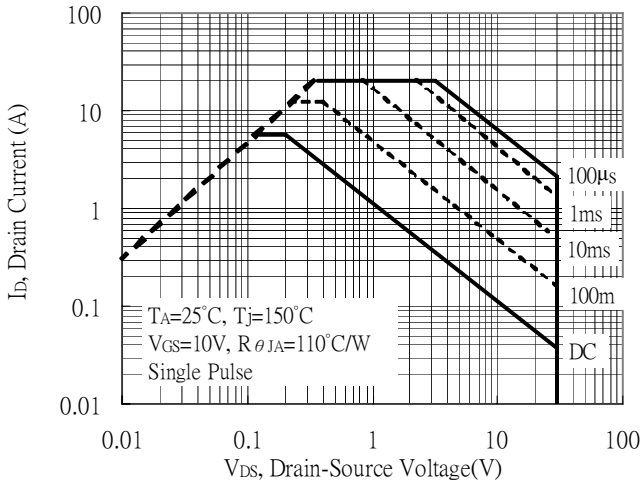

Transient Thermal Response Curves

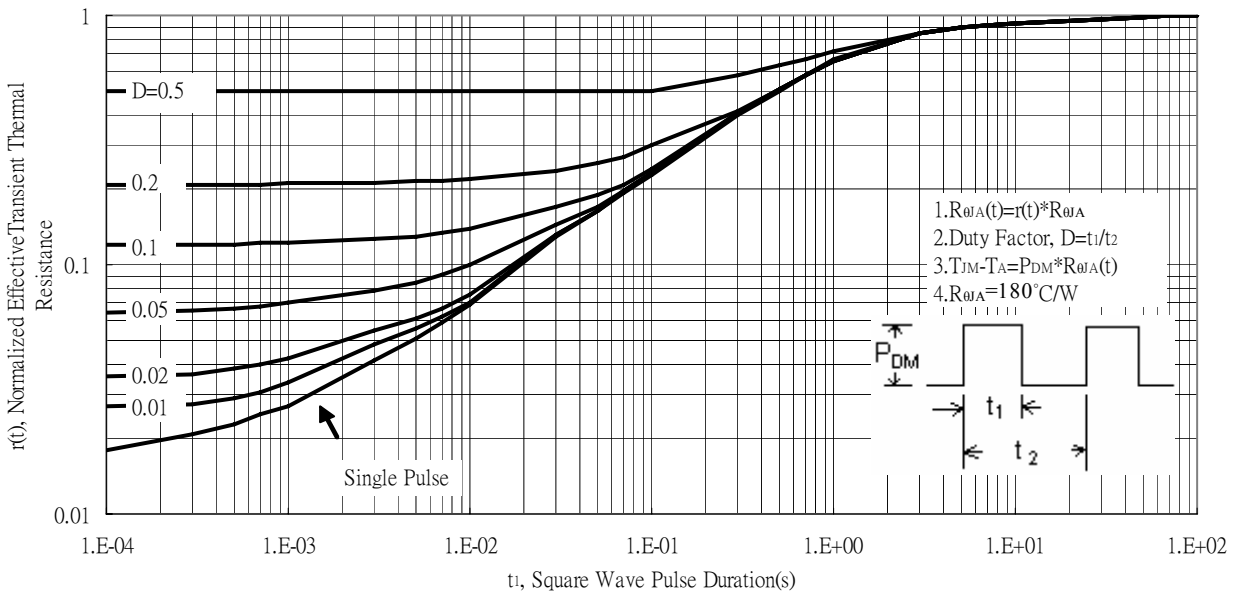

Reel Dimension

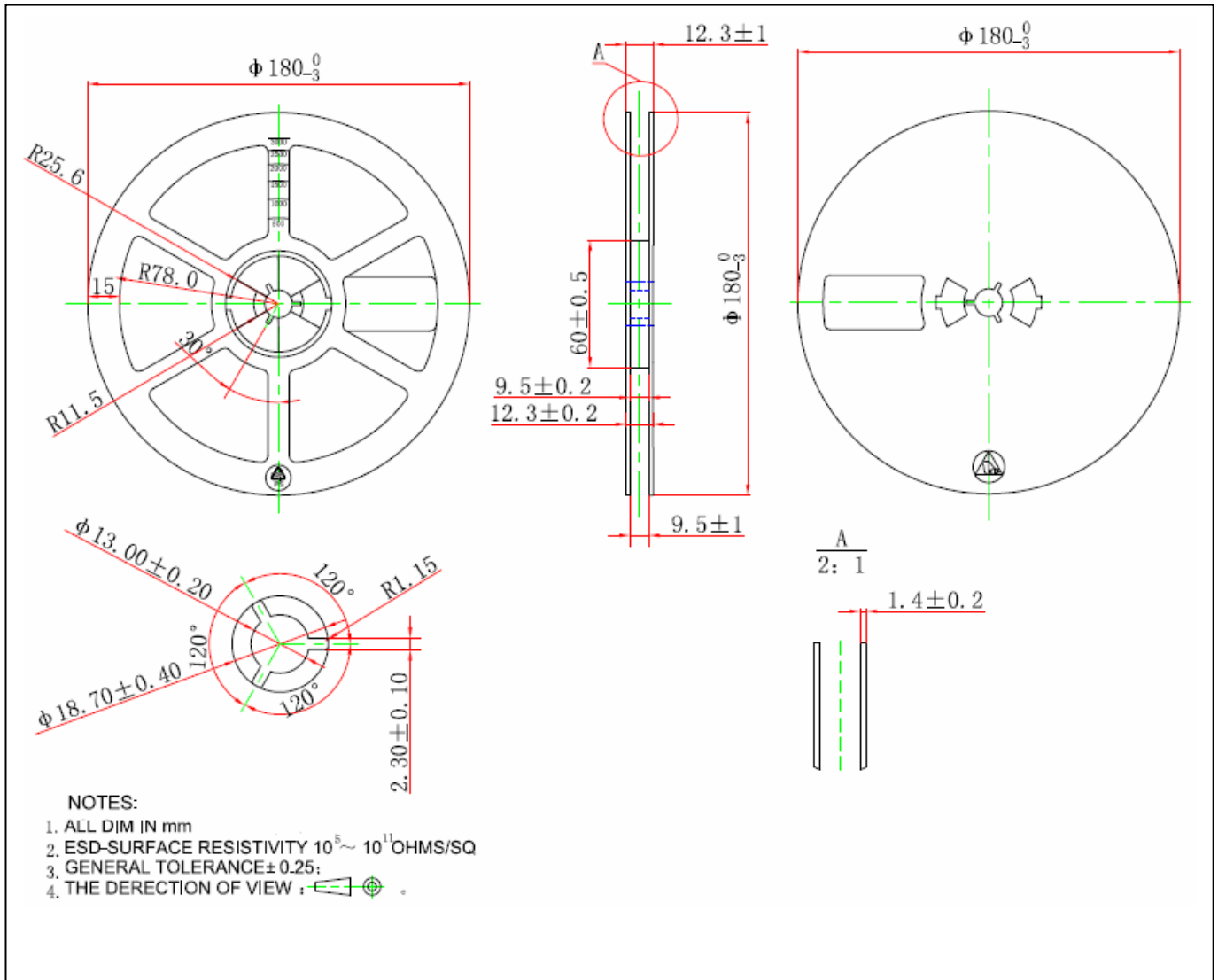

Carrier Tape Dimension

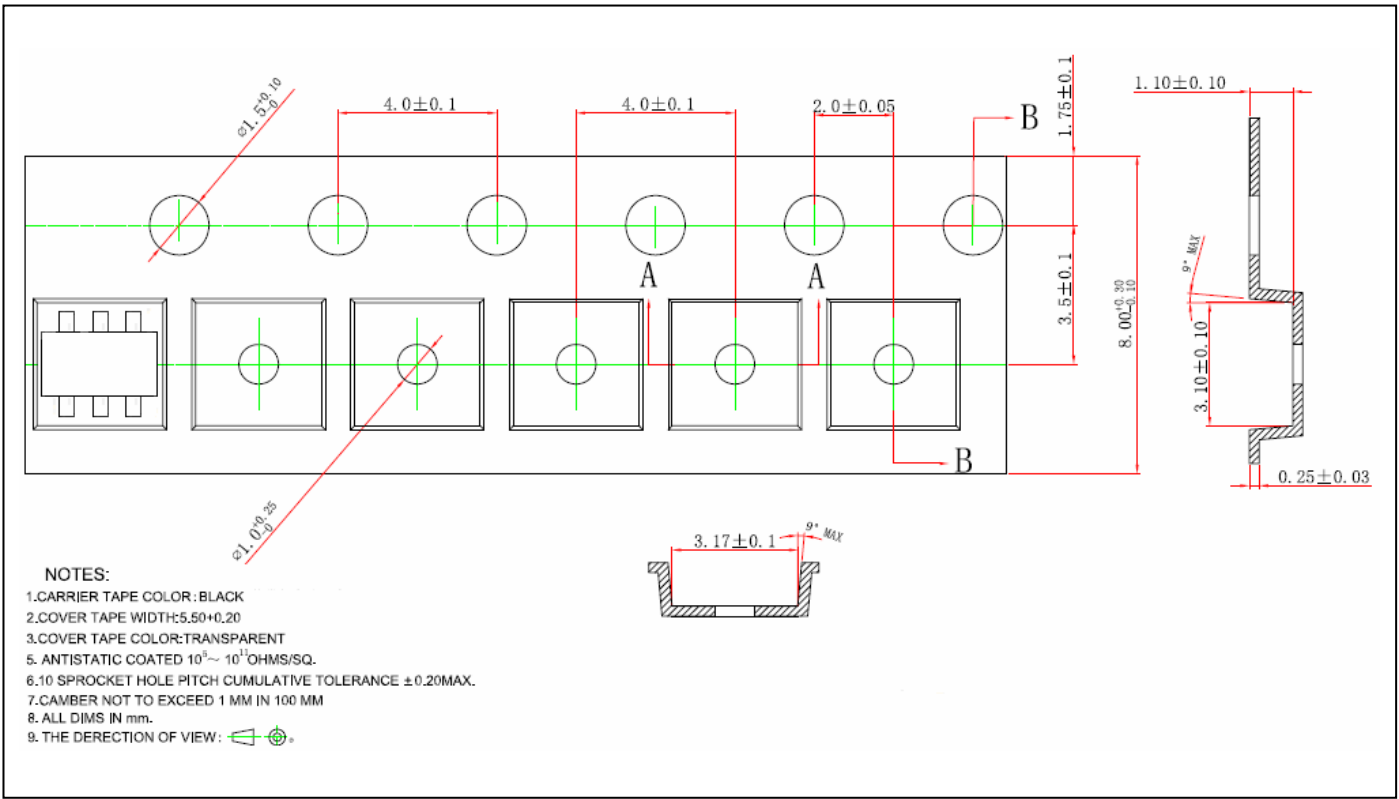

Recommended wave soldering condition

Product	Peak Temperature	Soldering Time
Pb-free devices	260 +0/-5 °C	5 +1/-1 seconds

Recommended temperature profile for IR reflow

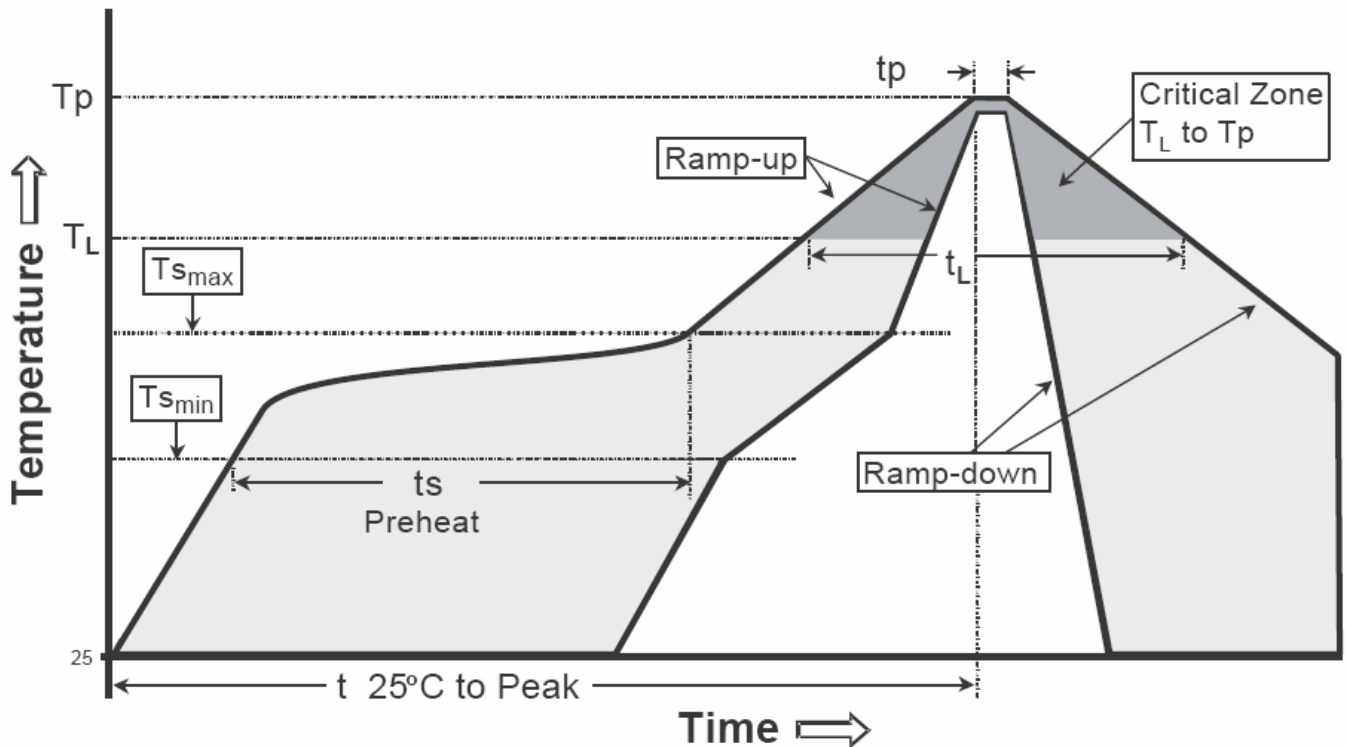

Profile feature	Sn-Pb eutectic Assembly	Pb-free Assembly
Average ramp-up rate (T _{smax} to T _p)	3°C/second max.	3°C/second max.
Preheat		
-Temperature Min(T _{s min})	100°C	150°C
-Temperature Max(T _{s max})	150°C	200°C
-Time(t _{s min} to t _{s max})	60-120 seconds	60-180 seconds
Time maintained above:		
-Temperature (T _L)	183°C	217°C
- Time (t _L)	60-150 seconds	60-150 seconds
Peak Temperature(T _P)	240 +0/-5 °C	260 +0/-5 °C
Time within 5°C of actual peak temperature(tp)	10-30 seconds	20-40 seconds
Ramp down rate	6°C/second max.	6°C/second max.
Time 25 °C to peak temperature	6 minutes max.	8 minutes max.

Note : All temperatures refer to topside of the package, measured on the package body surface.

TSOP-6 Dimension

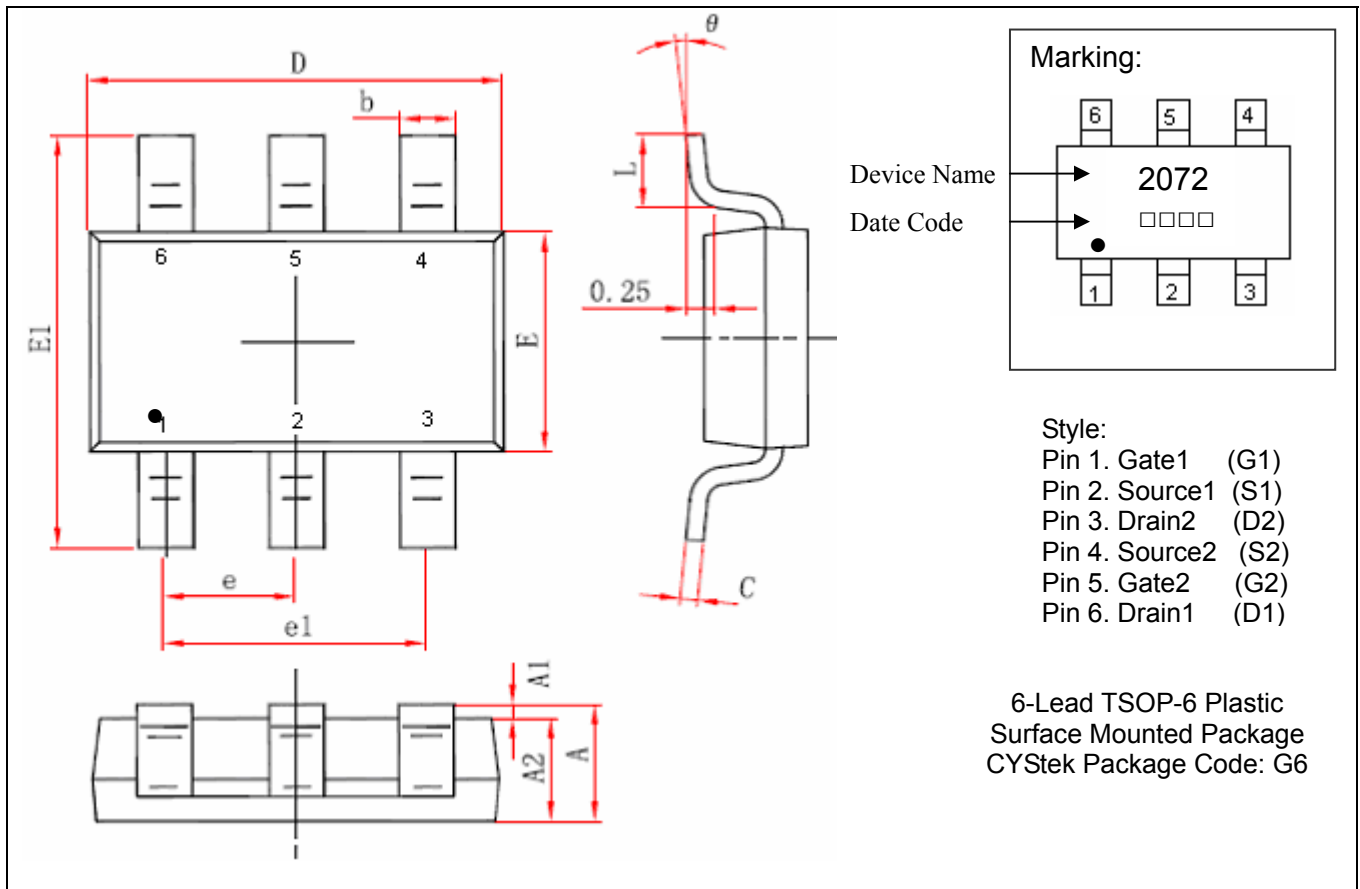

DIM	Millimeters		Inches		DIM	Millimeters		Inches	
	Min.	Max.	Min.	Max.		Min.	Max.	Min.	Max.
A	0.700	0.900	0.028	0.035	E	1.600	1.700	0.063	0.067
A1	0.000	0.100	0.000	0.004	E1	2.650	2.950	0.104	0.116
A2	0.700	0.800	0.028	0.031	e	0.95 (BSC)		0.037 (BSC)	
b	0.350	0.500	0.014	0.020	e1	1.90 (BSC)		0.075 (BSC)	
c	0.080	0.200	0.003	0.008	L	0.300	0.600	0.012	0.024
D	2.820	3.020	0.111	0.119	θ	0°	8°	0°	8°

Notes : 1.Controlling dimension : millimeters.
 2.Maximum lead thickness includes lead finish thickness, and minimum lead thickness is the minimum thickness of base material.
 3.If there is any question with packing specification or packing method, please contact your local CYStek sales office.

Material :

- Lead : Pure tin plated.
- Mold Compound : Epoxy resin family, flammability solid burning class:UL94V-0.

Important Notice:

- All rights are reserved. Reproduction in whole or in part is prohibited without the prior written approval of CYStek.
- CYStek reserves the right to make changes to its products without notice.
- CYStek **semiconductor products are not warranted to be suitable for use in Life-Support Applications, or systems.**
- CYStek assumes no liability for any consequence of customer product design, infringement of patents, or application assistance.