

P-CHANNEL ENHANCEMENT MODE POWER MOSFET

MTP2402Q8

BV _{DSS}	-20V
I _D	-8.3A
R _{DS(on)} @V _{GS} =-10V, I _D =-7A	22mΩ (typ)
R _{DS(on)} @V _{GS} =-4.5V, I _D =-4.5A	27mΩ (typ)
R _{DS(on)} @V _{GS} =-2.5V, I _D =-2A	35mΩ (typ)

Description

The MTP2402Q8 is a P-channel enhancement-mode MOSFET, providing the designer with the best combination of fast switching, ruggedized device design, low on-resistance and cost effectiveness. The SOP-8 package is universally preferred for all commercial-industrial surface mount applications and suited for low voltage applications such as DC/DC converters.

Features

- Simple drive requirement
- Low on-resistance
- Fast switching speed
- Pb-free lead plating package

Equivalent Circuit

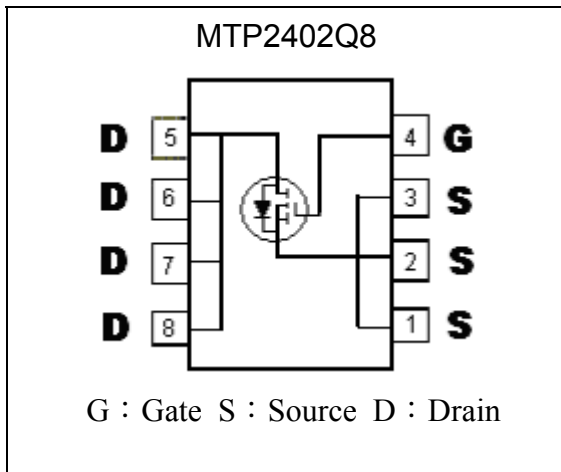

Outline

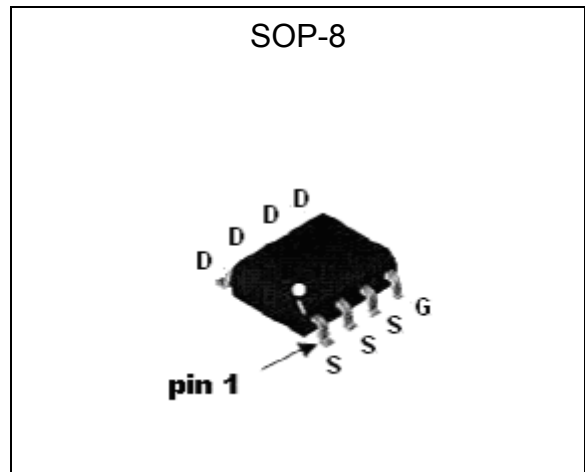

Ordering Information

Device	Package	Shipping	Marking
MTP2402Q8	SOP-8 (Pb-free lead plating package)	2500 pcs/ Tape & Reel	2402



Absolute Maximum Ratings (Ta=25°C)

Parameter	Symbol	Limits	Unit
Drain-Source Breakdown Voltage	BV _{DSS}	-20	V
Gate-Source Voltage	V _{GS}	±12	
Continuous Drain Current (Note 1)	I _D	T _A =25°C, V _{GS} =-4.5V	-8.3
		T _A =70°C, V _{GS} =-4.5V	-6.6
Pulsed Drain Current (Note 2)	I _{DM}	-30	A
Total Power Dissipation (Note 1)	P _D	T _A =25°C	3.1
		T _A =70°C	2
Operating Junction and Storage Temperature Range	T _j ; T _{stg}	-55~+150	°C
Thermal Resistance, Junction-to-Ambient (Note 1)	R _{th,j-a}	40	°C/W

Note : 1.Surface mounted on FR-4 board, t≤10sec; 125 °C/W when mounted on minimum copper pad.
 The value in any given application depends on the user's specific board design.
 2.Pulse width ≤300μs, Duty Cycle≤2%

Electrical Characteristics (Tj=25°C, unless otherwise specified)

Symbol	Min.	Typ.	Max.	Unit	Test Conditions
Static					
BV _{DSS}	-20	-	-	V	V _{GS} =0, I _D =-250μA
V _{GS(th)}	-0.5	-0.7	-1.0	V	V _{DS} =V _{GS} , I _D =-250μA
I _{GSS}	-	-	±100	nA	V _{GS} =±12V, V _{DS} =0
I _{DSS}	-	-	-1	μA	V _{DS} =-16V, V _{GS} =0
	-	-	-25		V _{DS} =-16V, V _{GS} =0, T _j =125°C
*R _{DS(ON)}	-	22	30	mΩ	V _{GS} =-10V, I _D =-7A
	-	27	35		V _{GS} =-4.5V, I _D =-4.5A
	-	35	50		V _{GS} =-2.5V, I _D =-2A
*G _{FS}	-	13	-	S	V _{DS} =-10V, I _D =-7A
Dynamic					
C _{iss}	-	1916	-	pF	V _{DS} =-10V, V _{GS} =0, f=1MHz
C _{oss}	-	159	-		
C _{rss}	-	132	-		
*t _{d(ON)}	-	11	-	ns	V _{DD} =-10V, I _D =-2A, V _{GS} =-10V, R _G =3.3 Ω
*t _r	-	15	-		
*t _{d(OFF)}	-	44	-		
*t _f	-	18	-		
*Q _g	-	15	-	nC	V _{DS} =-16V, V _{GS} =-4.5V, I _D =-7A
*Q _{gs}	-	3	-		
*Q _{gd}	-	6.3	-		
Source Drain Diode					
*I _S	-	-	-2	A	V _{GS} =0V, I _S =-2A
*I _{SM}	-	-	-8		
*V _{SD}	-	-0.76	-1.2	V	
*t _{rr}	-	22	-	ns	I _F =7A, dI _F /dt=100A/μs
*Q _{rr}	-	20	-	nC	

*Pulse Test : Pulse Width ≤300μs, Duty Cycle≤2%

Typical Characteristics

Typical Output Characteristics

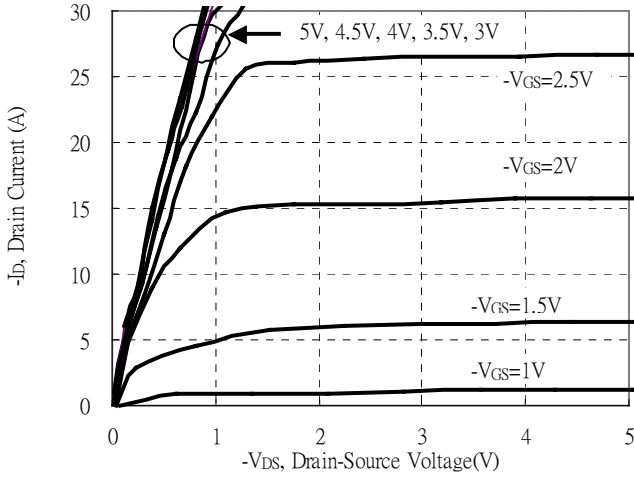

Brekdown Voltage vs Ambient Temperature

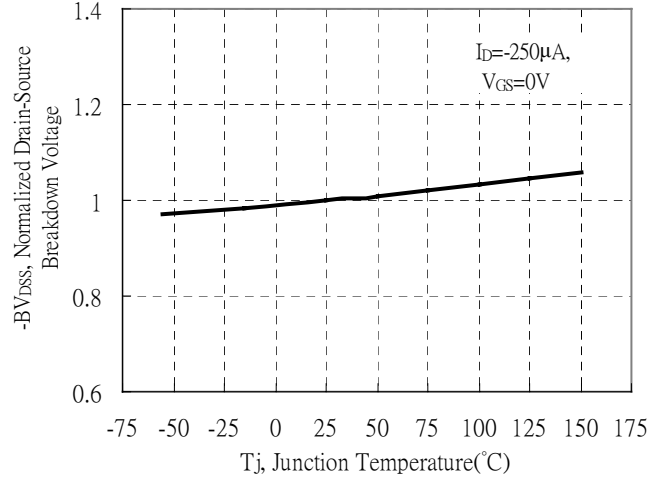

Static Drain-Source On-State resistance vs Drain Current

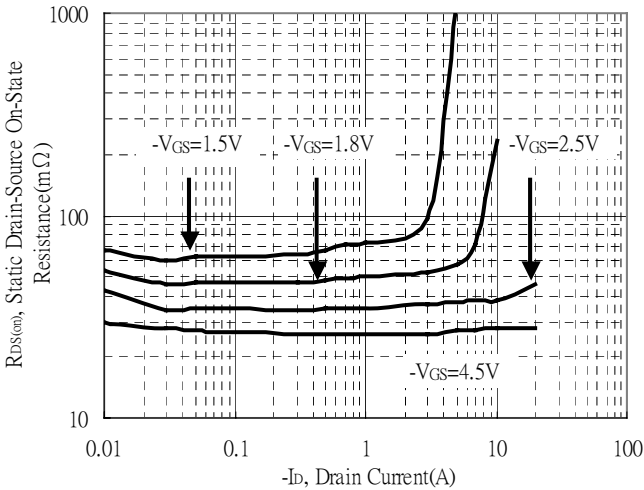

Reverse Drain Current vs Source-Drain Voltage

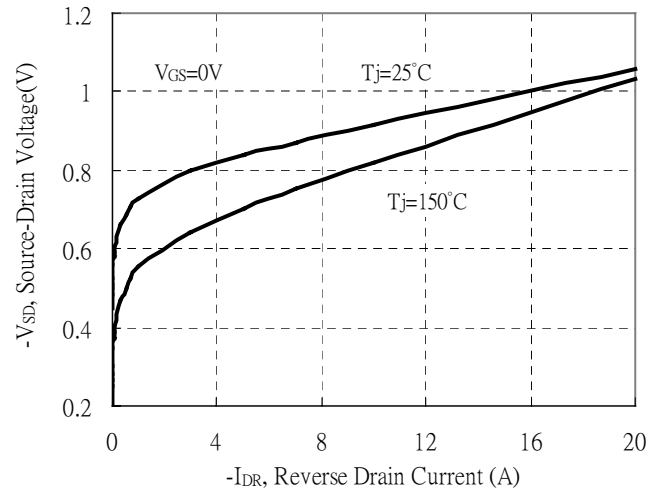

Static Drain-Source On-State Resistance vs Gate-Source Voltage

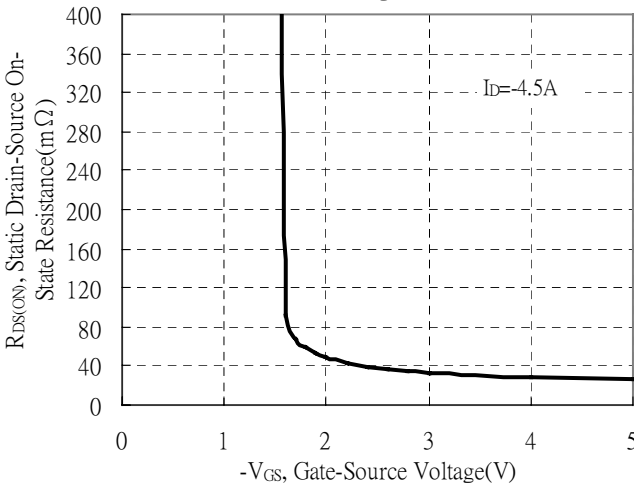

Drain-Source On-State Resistance vs Junction Temperature

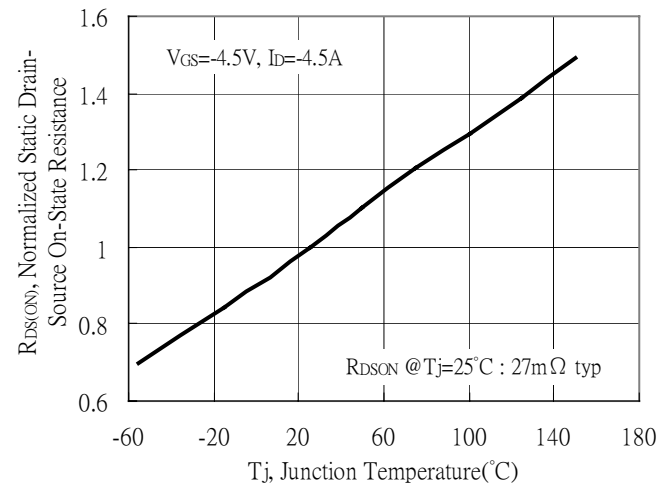

Typical Characteristics(Cont.)

Capacitance vs Drain-to-Source Voltage

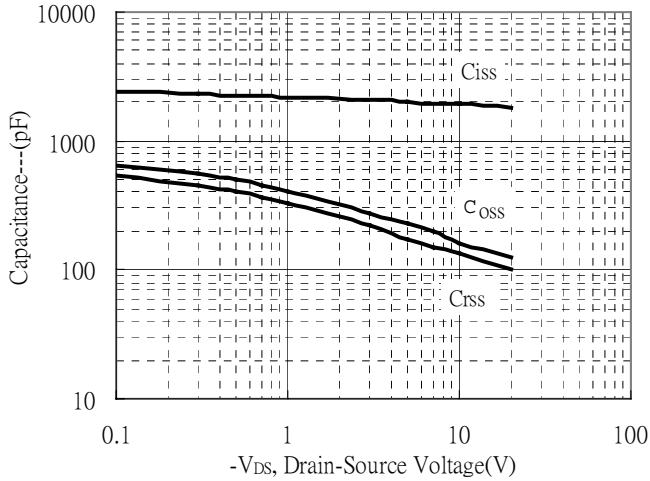

Threshold Voltage vs Junction Temperature

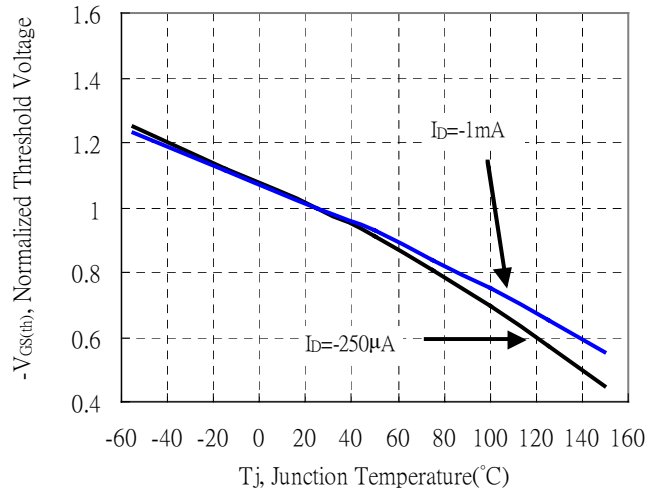

Single Pulse Power Rating, Junction to Ambient
 (Note on page 2)

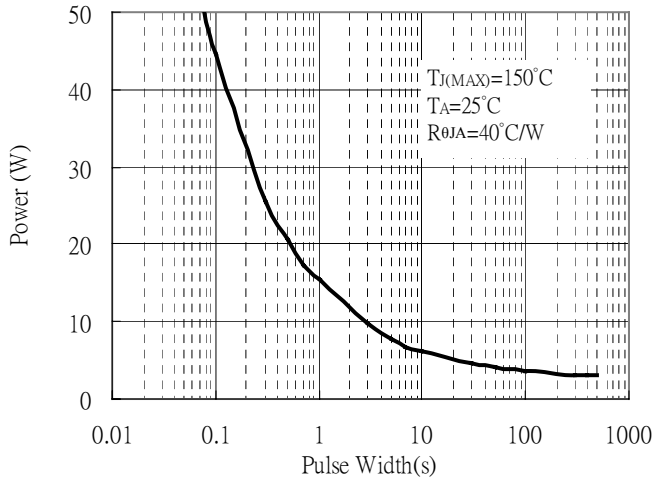

Gate Charge Characteristics

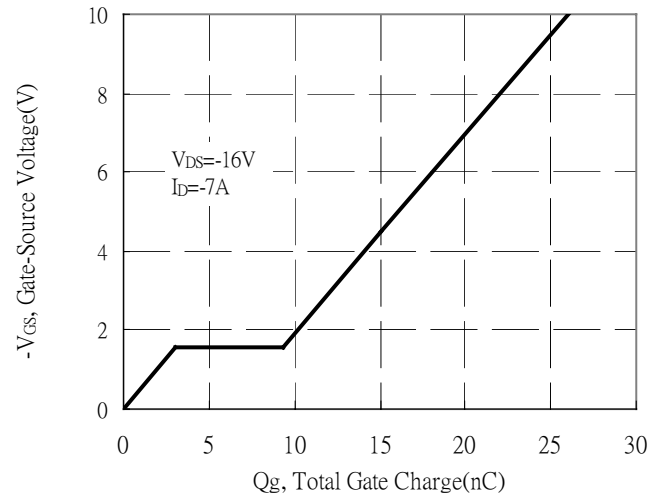

Maximum Safe Operating Area

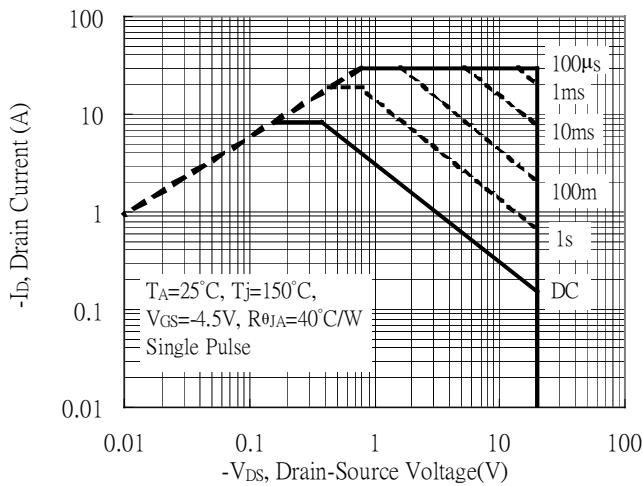

Maximum Drain Current vs Junction Temperature

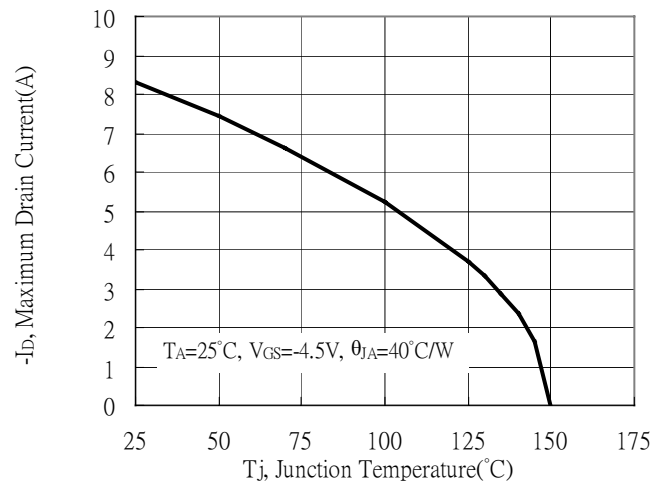

Typical Characteristics(Cont.)

Typical Transfer Characteristics

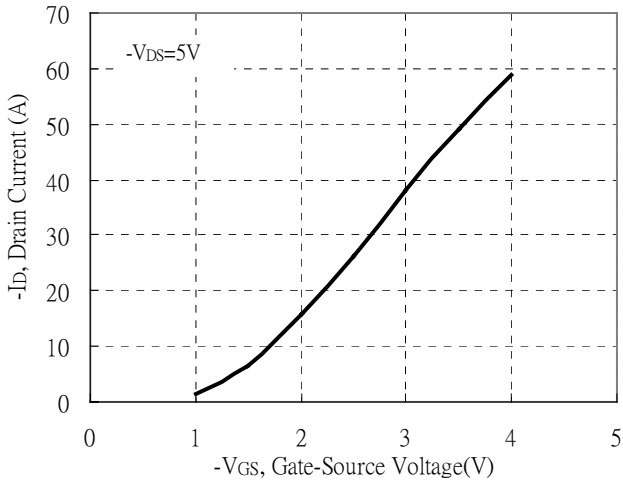

Forward Transfer Admittance vs Drain Current

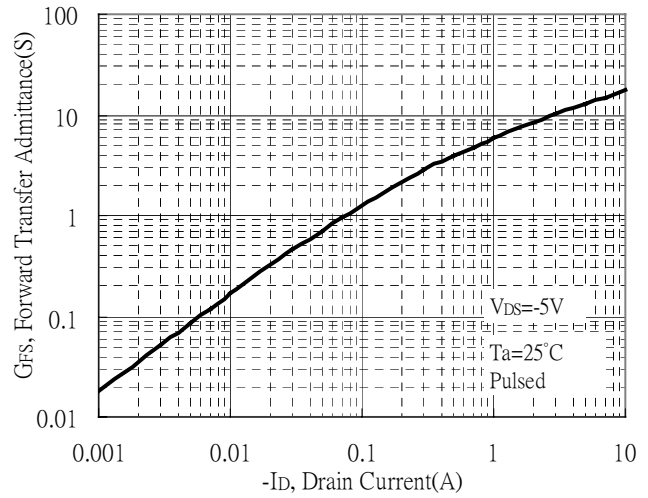

Transient Thermal Response Curves

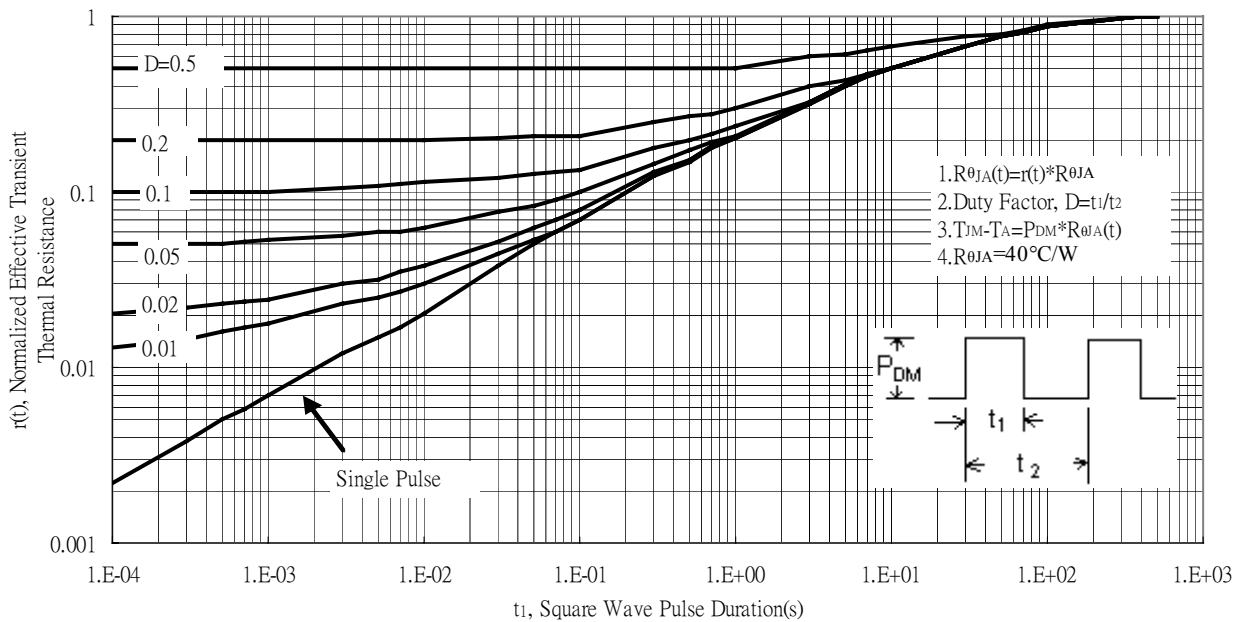

Reel Dimension

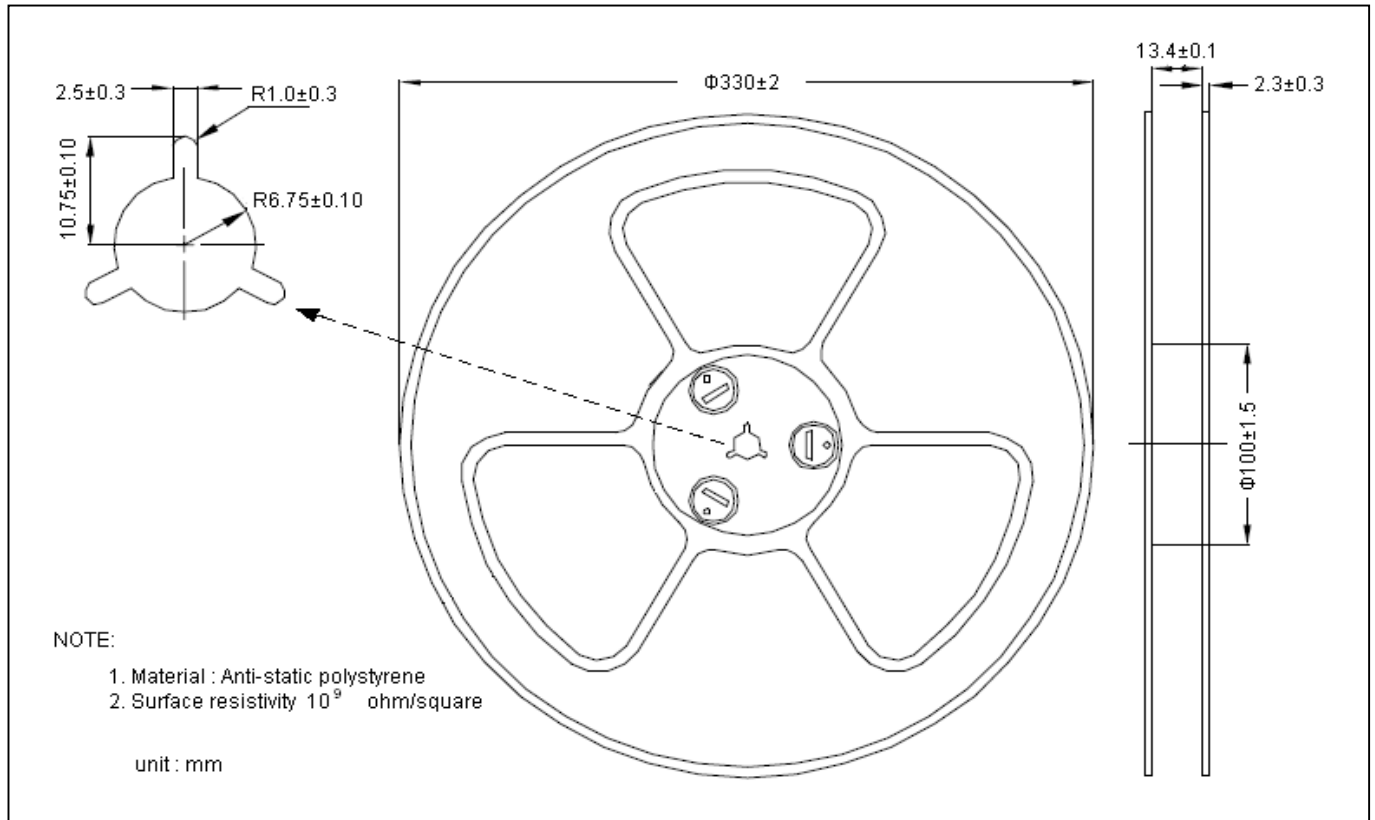

Carrier Tape Dimension

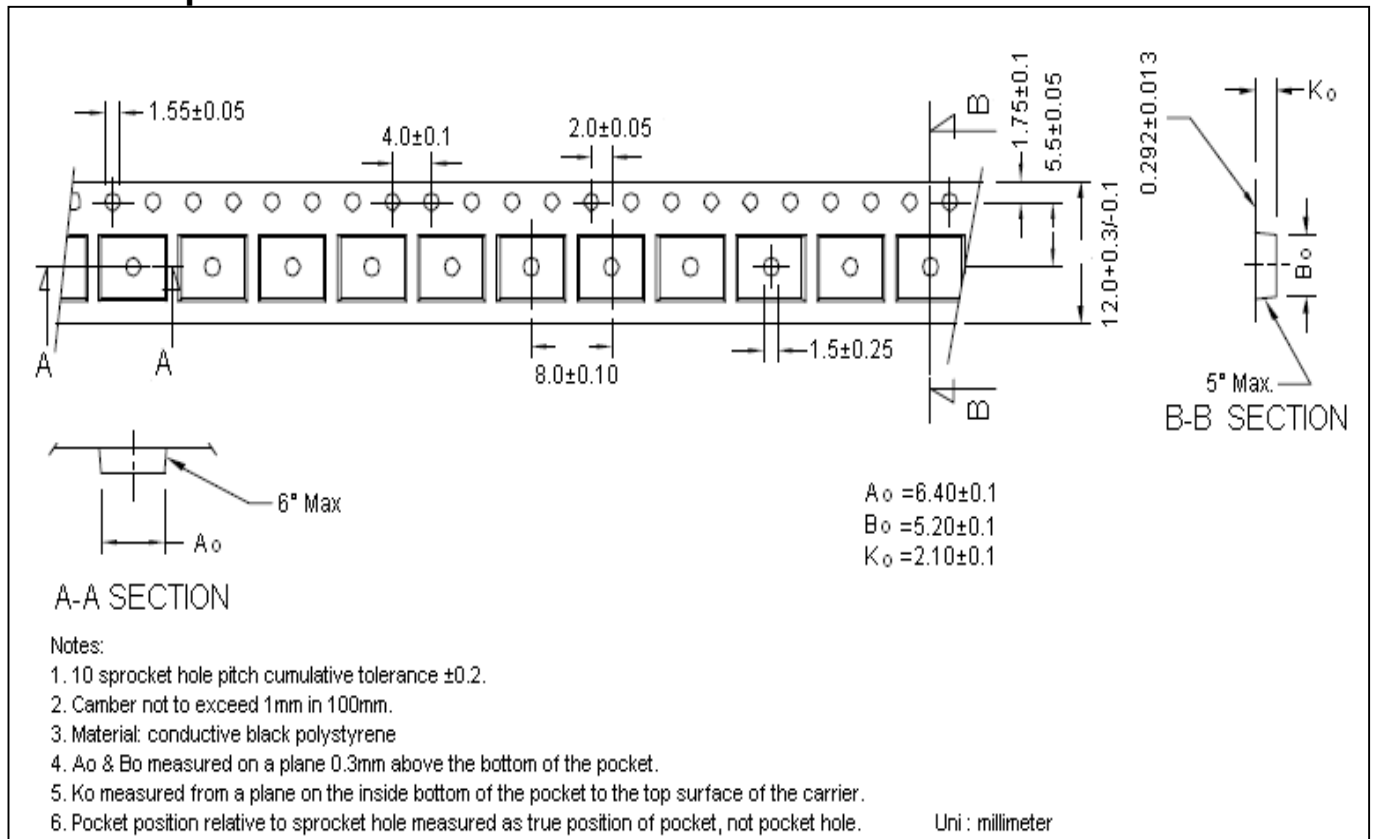

Recommended wave soldering condition

Product	Peak Temperature	Soldering Time
Pb-free devices	260 +0/-5 °C	5 +1/-1 seconds

Recommended temperature profile for IR reflow

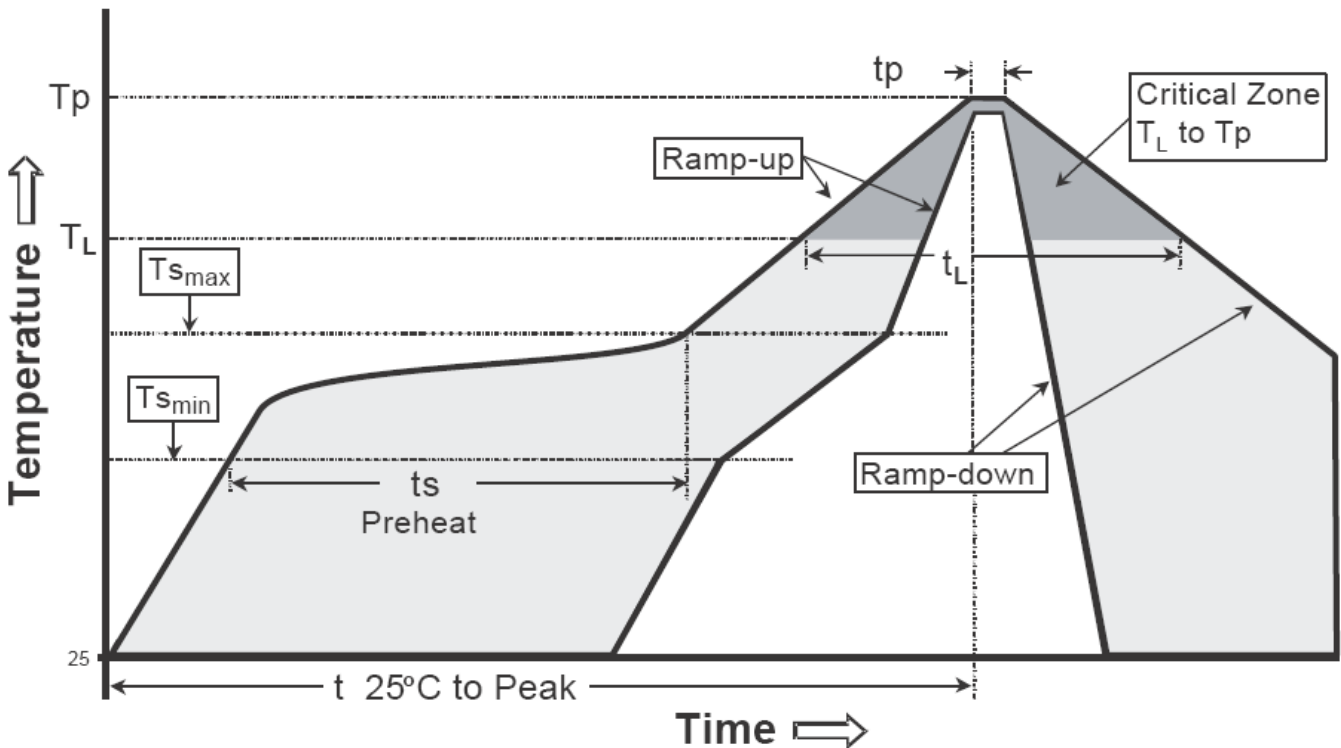

Profile feature	Sn-Pb eutectic Assembly	Pb-free Assembly
Average ramp-up rate (Tsmmax to Tp)	3°C/second max.	3°C/second max.
Preheat		
-Temperature Min(Ts min)	100°C	150°C
-Temperature Max(Ts max)	150°C	200°C
-Time(ts min to ts max)	60-120 seconds	60-180 seconds
Time maintained above:		
-Temperature (TL)	183°C	217°C
- Time (tL)	60-150 seconds	60-150 seconds
Peak Temperature(TP)	240 +0/-5 °C	260 +0/-5 °C
Time within 5°C of actual peak temperature(tp)	10-30 seconds	20-40 seconds
Ramp down rate	6°C/second max.	6°C/second max.
Time 25 °C to peak temperature	6 minutes max.	8 minutes max.

Note : All temperatures refer to topside of the package, measured on the package body surface.

SOP-8 Dimension

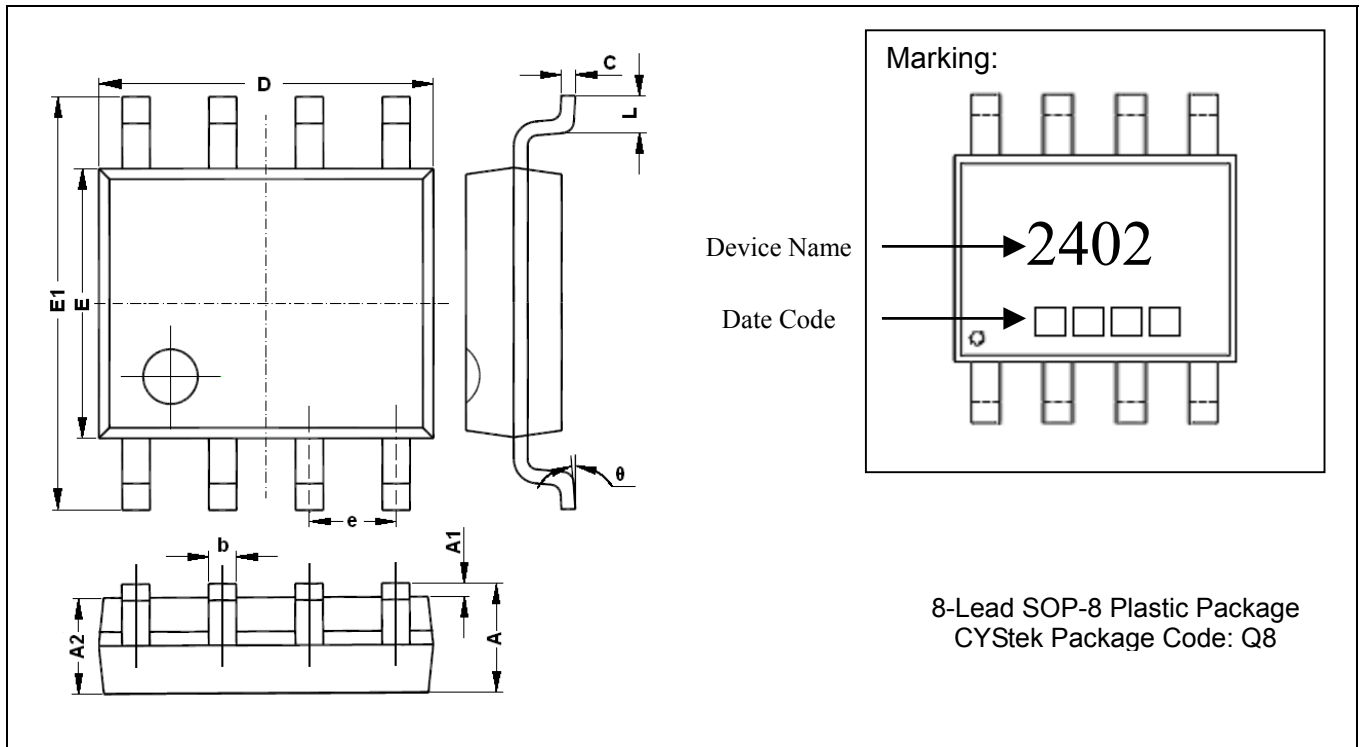

DIM	Millimeters		Inches		DIM	Millimeters		Inches	
	Min.	Max.	Min.	Max.		Min.	Max.	Min.	Max.
A	1.350	1.750	0.053	0.069	E	3.800	4.000	0.150	0.157
A1	0.100	0.250	0.004	0.010	E1	5.800	6.200	0.228	0.244
A2	1.350	1.550	0.053	0.061	e	1.270	(BSC)	0.050	(BSC)
b	0.330	0.510	0.013	0.020	L	0.400	1.270	0.016	0.050
c	0.170	0.250	0.006	0.010	θ	0	8°	0	8°
D	4.700	5.100	0.185	0.200					

Notes: 1.Controlling dimension: millimeters.
 2.Maximum lead thickness includes lead finish thickness, and minimum lead thickness is the minimum thickness of base material.
 3.If there is any question with packing specification or packing method, please contact your local CYStek sales office.

Material:

- Lead: Pure tin plated.
- Mold Compound: Epoxy resin family, flammability solid burning class: UL94V-0.

Important Notice:

- All rights are reserved. Reproduction in whole or in part is prohibited without the prior written approval of CYStek.
- CYStek reserves the right to make changes to its products without notice.
- CYStek **semiconductor products are not warranted to be suitable for use in Life-Support Applications, or systems.**
- CYStek assumes no liability for any consequence of customer product design, infringement of patents, or application assistance.