

P-CHANNEL Enhancement Mode MOSFET

MTP2303N3

BV _{DSS}	-30V
I _D @V _{GS} =-10V, T _A =25°C	-3.7A
R _{DSON} @V _{GS} =-10V, I _D =-3A	100mΩ (max)
R _{DSON} @V _{GS} =-4.5V, I _D =-2.6A	150mΩ (max)

Features

- Low gate charge
- Compact and low profile SOT-23 package
- Advanced trench process technology
- High density cell design for ultra low on resistance
- Pb-free lead plating package

Equivalent Circuit

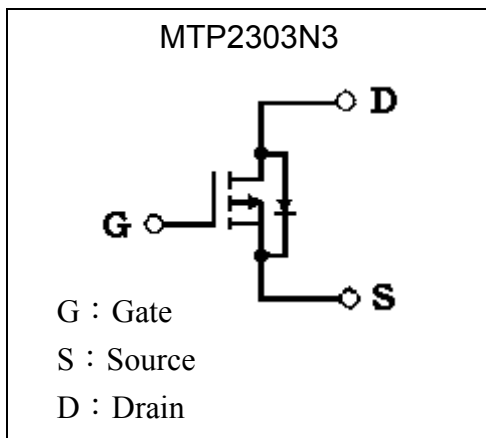

Outline

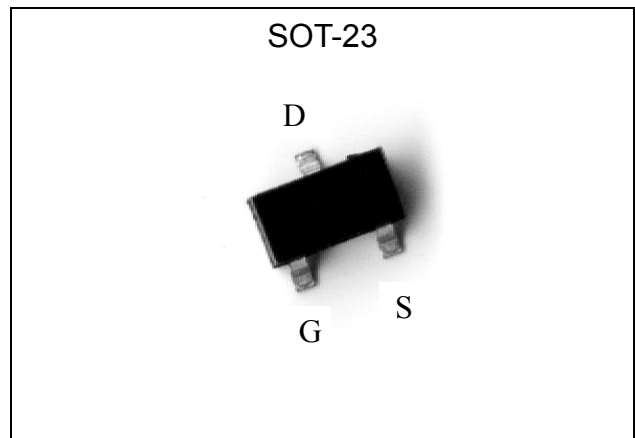

Ordering Information

Device	Package	Shipping
MTP2303N3-0-T1-G	SOT-23 (Pb-free lead plating and halogen-free package)	3000 pcs / tape & reel

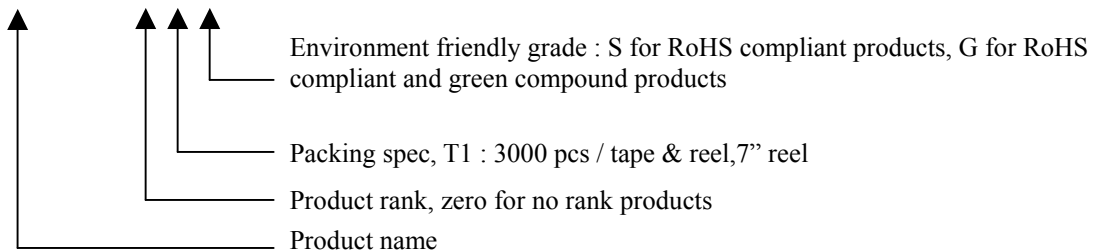



Absolute Maximum Ratings (Ta=25°C)

Parameter	Symbol	Limits	Unit
Drain-Source Voltage	V _{DS}	-30	V
Gate-Source Voltage	V _{GS}	±20	
Continuous Drain Current @V _{GS} =-10V, T _A =25°C (Note 1)	I _D	-3.7	A
Continuous Drain Current @V _{GS} =-10V, T _A =70°C (Note 1)		-2.9	
Pulsed Drain Current (Note 2)	I _{DM}	-12	
Maximum Power Dissipation	P _D	1.38	W
Linear Derating Factor		0.01	W/°C
ESD susceptibility (Note 3)		400	V
Operating Junction and Storage Temperature	T _j , T _{stg}	-55~+150	°C

- Note : 1. Surface mounted on 1 in² copper pad of FR-4 board, 270°C/W when mounted on minimum copper pad.
 2. Pulse width limited by maximum junction temperature.
 3. Human body model, 1.5kΩ in series with 100pF

Thermal Performance

Parameter	Symbol	Limit	Unit
Thermal Resistance, Junction-to-Ambient	R _{th,ja}	90	°C/W

Note : Surface mounted on 1 in² copper pad of FR-4 board, 270°C/W when mounted on minimum copper pad.

Electrical Characteristics (Tj=25°C, unless otherwise specified)

Symbol	Min.	Typ.	Max.	Unit	Test Conditions
Static					
BV _{DSS}	-30	-	-	V	V _{GS} =0V, I _D =-250μA
ΔBV _{DSS} /ΔT _j	-	-0.02	-	V/°C	Reference to 25°C, I _D =-1mA
V _{GS(th)}	-1.0	-	-	V	V _{DS} =V _{GS} , I _D =-250μA
I _{GSS}	-	-	±100	nA	V _{GS} =±20V, V _{DS} =0V
I _{DSS}	-	-	-1	μA	V _{DS} =-30V, V _{GS} =0V
	-	-	-25		V _{DS} =-24V, V _{GS} =0V, T _j =55°C
*R _{D(S)ON}	-	-	100	mΩ	I _D =-3.0A, V _{GS} =-10V
	-	-	150		I _D =-2.6A, V _{GS} =-4.5V
*G _{FS}	-	3.8	-	S	V _{DS} =-10V, I _D =-3A
	-	2.5	-	S	V _{DS} =-6V, I _D =-0.65A
Dynamic					
C _{iss}	-	612	-	pF	V _{DS} =-25V, V _{GS} =0V, f=1MHz
C _{oss}	-	66	-		
C _{rss}	-	55	-		

* $t_{d(ON)}$	-	8	-	ns	$V_{DS}=-15V, I_D=-1A, V_{GS}=-10V, R_D=15\Omega, R_G=3.3\Omega$
* t_r	-	5	-		
* $t_{d(OFF)}$	-	20	-		
* t_f	-	7	-		
* Q_g	-	5	8	nC	$V_{DS}=-24V, I_D=-3A, V_{GS}=-4.5V$
* Q_{gs}	-	1	-		
* Q_{gd}	-	3	-		
Source-Drain Diode					
* I_{SD}	-	-	-3	A	
* I_{SM}	-	-	-12	A	
* V_{SD}	-	-	-1.2	V	$V_{GS}=0V, I_S=-1.2A$

*Pulse Test : Pulse Width $\leq 300\mu s$, Duty Cycle $\leq 2\%$

Recommended Soldering Footprint

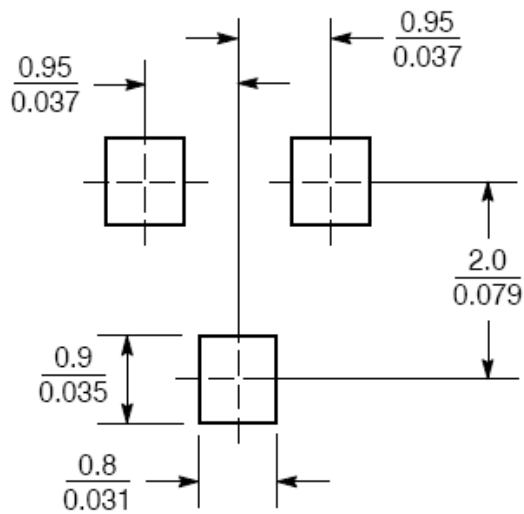

Unit : $\frac{mm}{inches}$



Typical Characteristics

Typical Output Characteristics

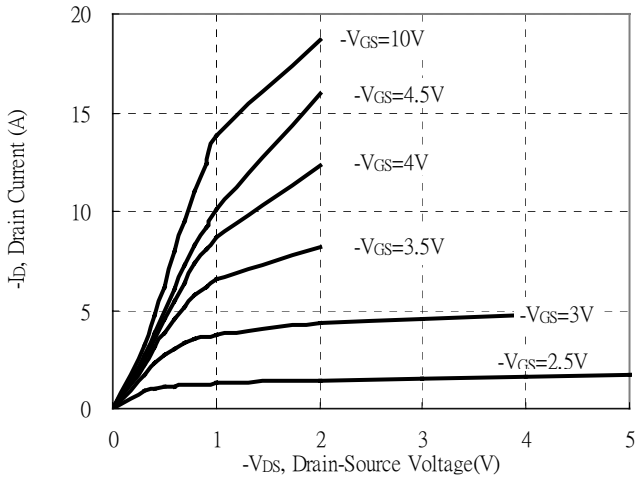

Brekdown Voltage vs Ambient Temperature

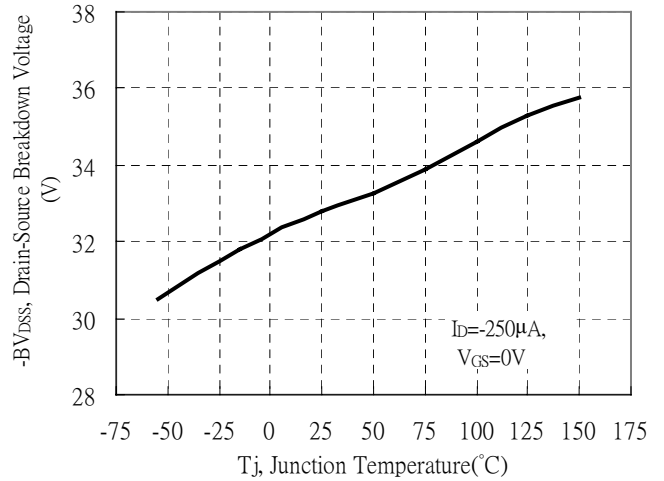

Static Drain-Source On-State resistance vs Drain Current

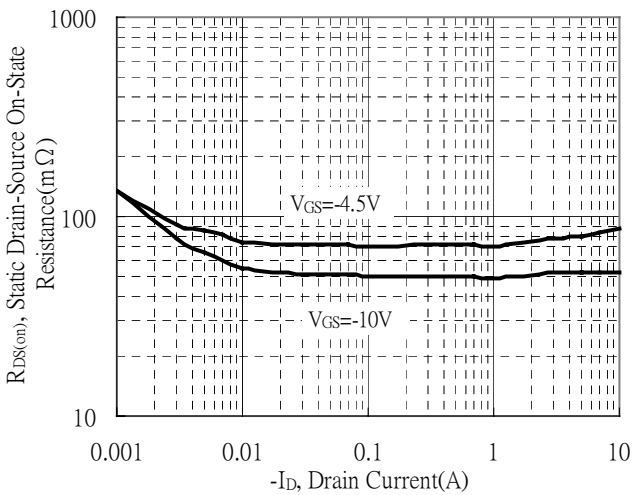

Reverse Drain Current vs Source-Drain Voltage

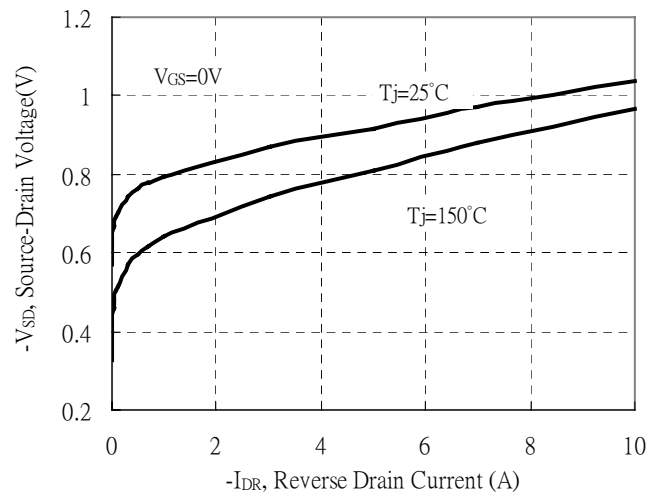

Static Drain-Source On-State Resistance vs Gate-Source Voltage

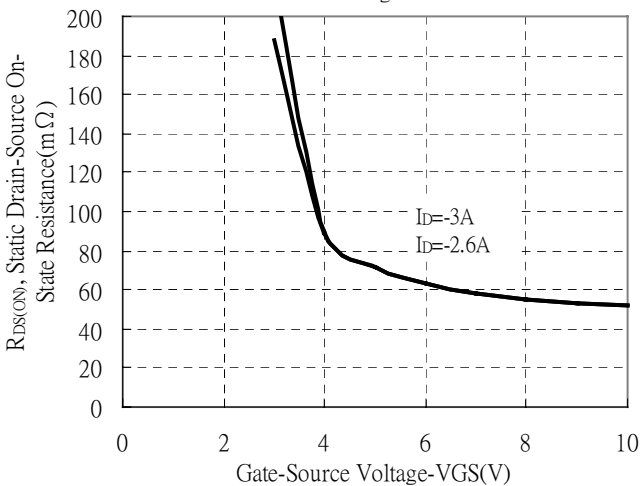

Drain-Source On-State Resistance vs Junction Temperature

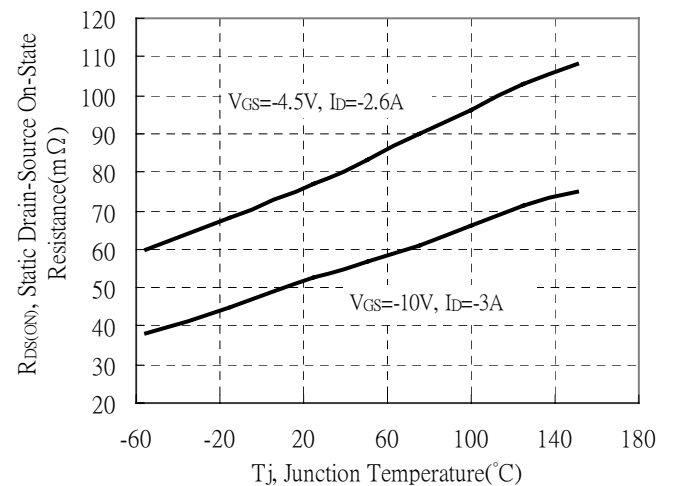



Typical Characteristics(Cont.)

Capacitance vs Drain-to-Source Voltage

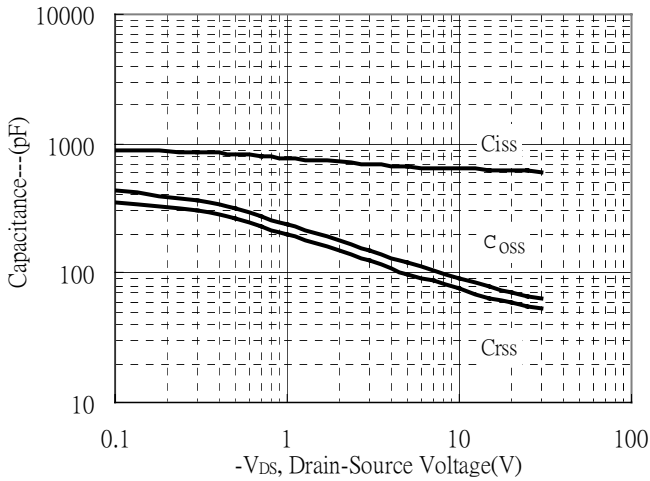

Threshold Voltage vs Junction Temperature

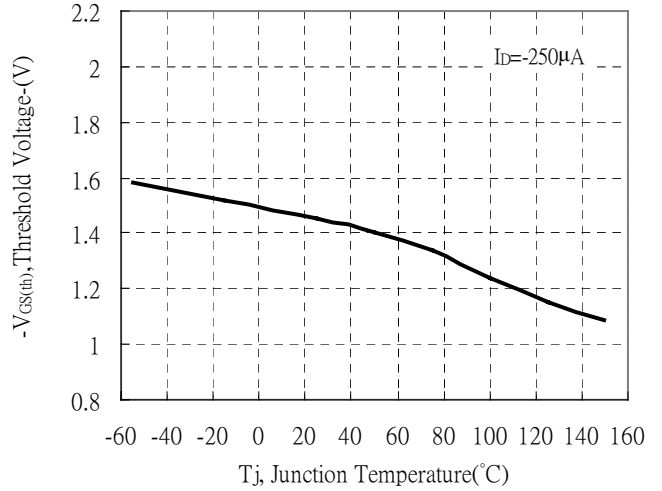

Forward Transfer Admittance vs Drain Current

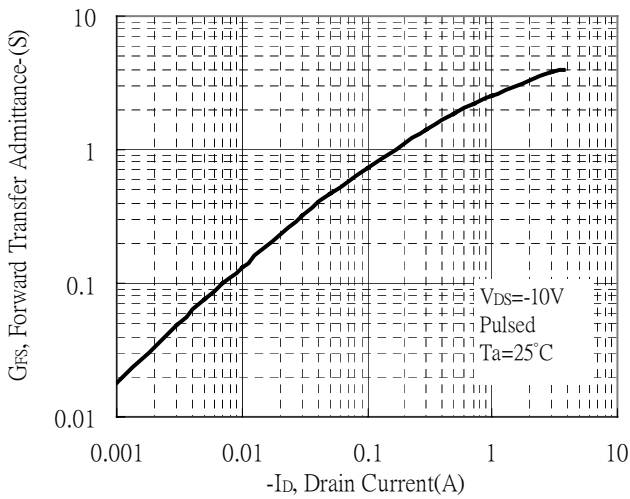

Gate Charge Characteristics

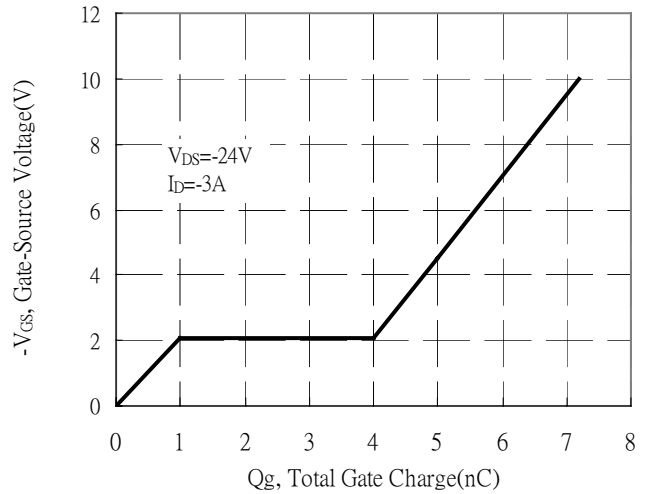

Maximum Safe Operating Area

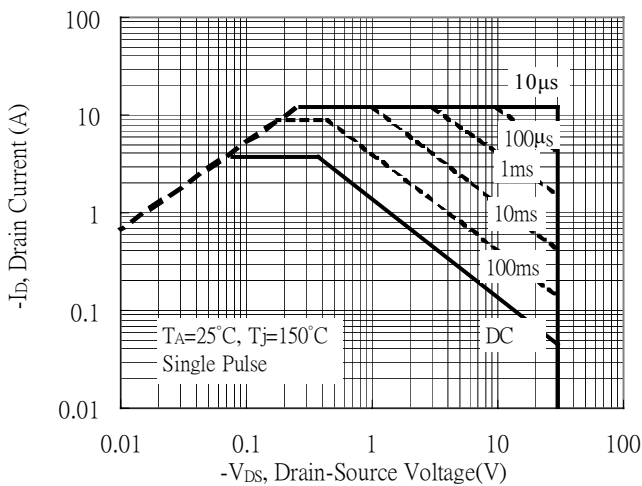

Maximum Drain Current vs Junction Temperature

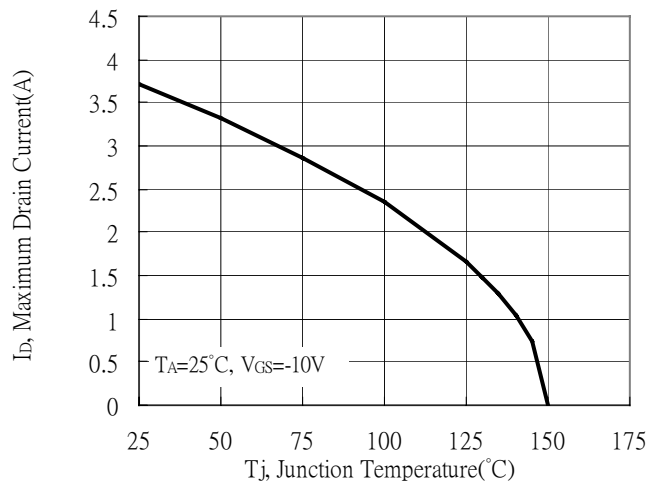

Typical Characteristics(Cont.)

Power Derating Curve

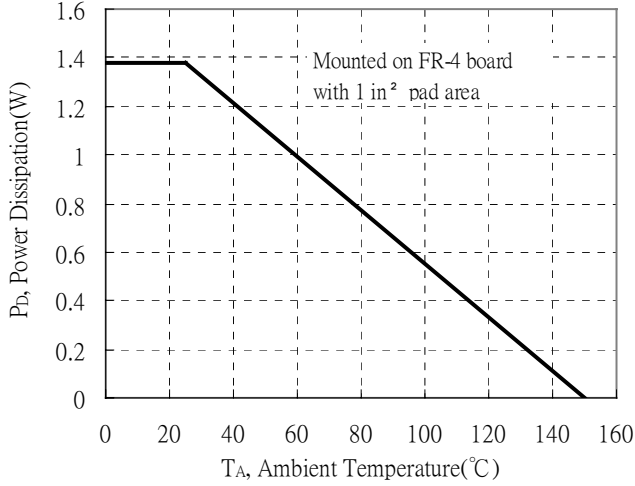

Transient Thermal Response Curves

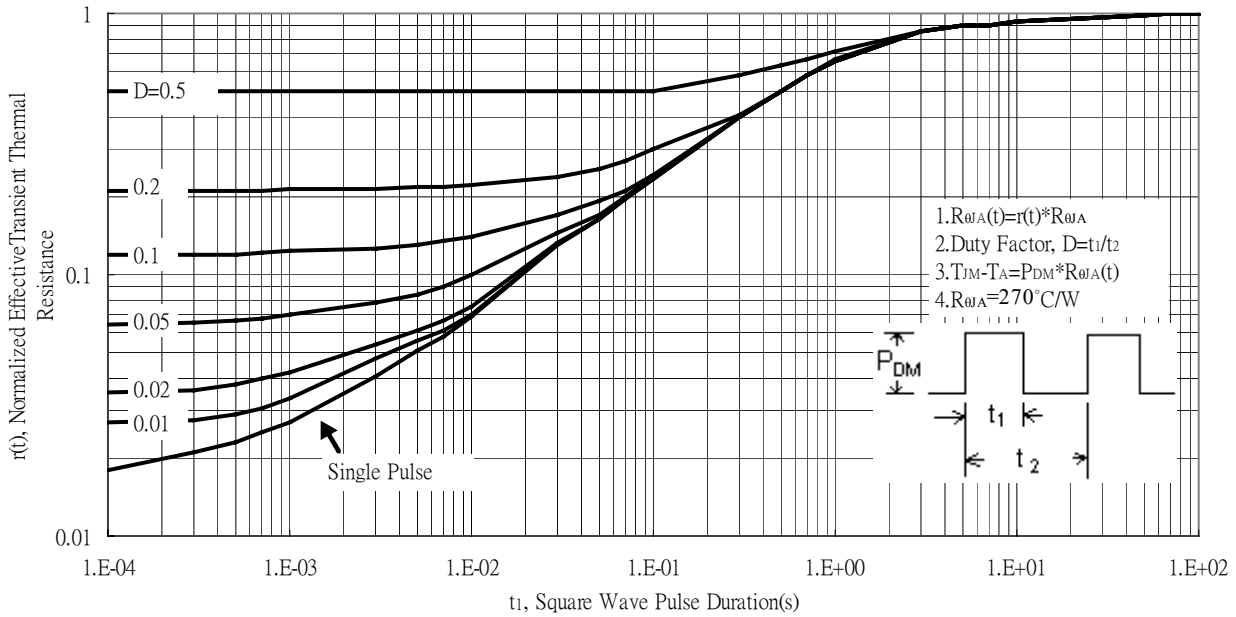

Reel Dimension

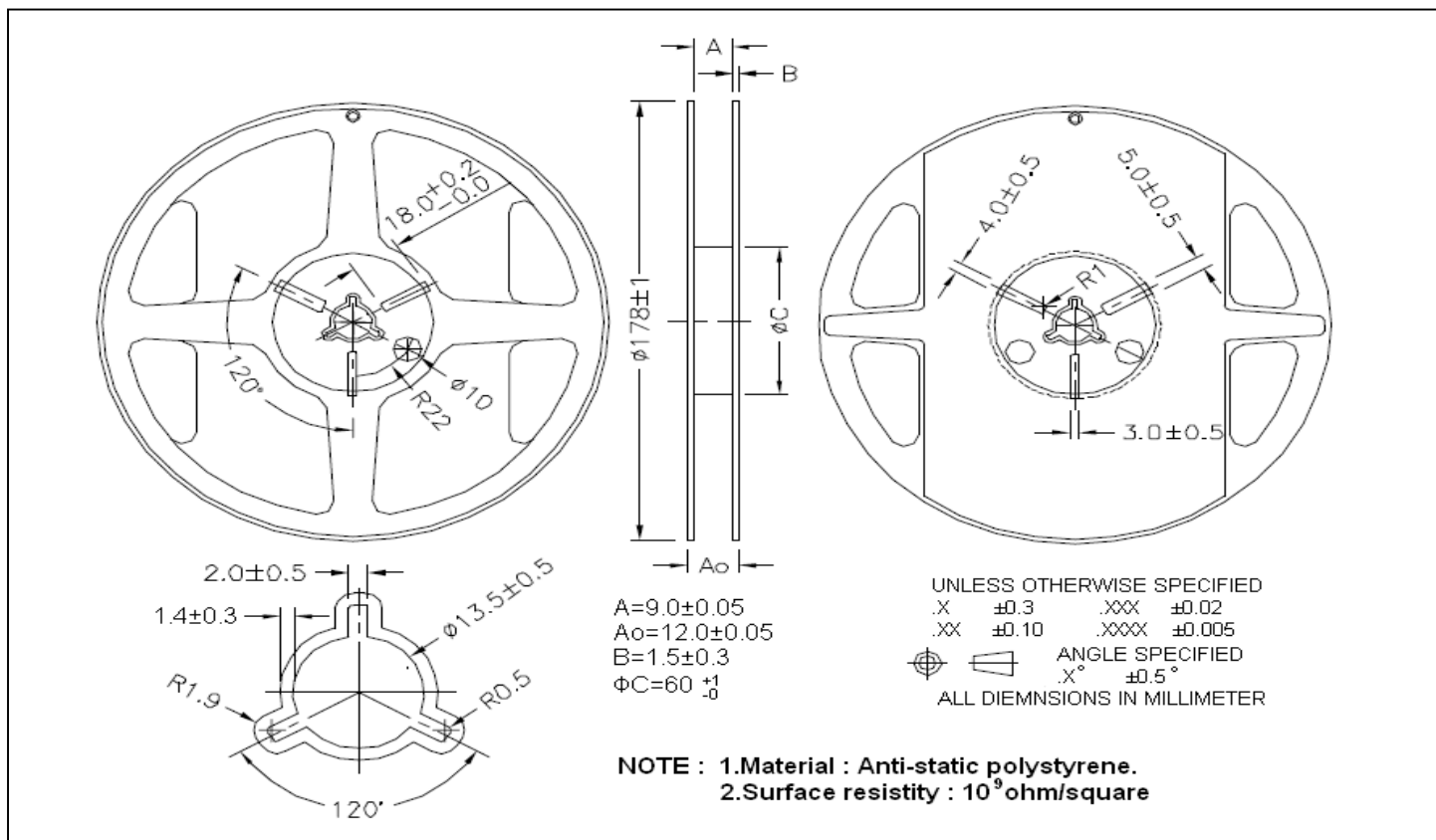

Carrier Tape Dimension

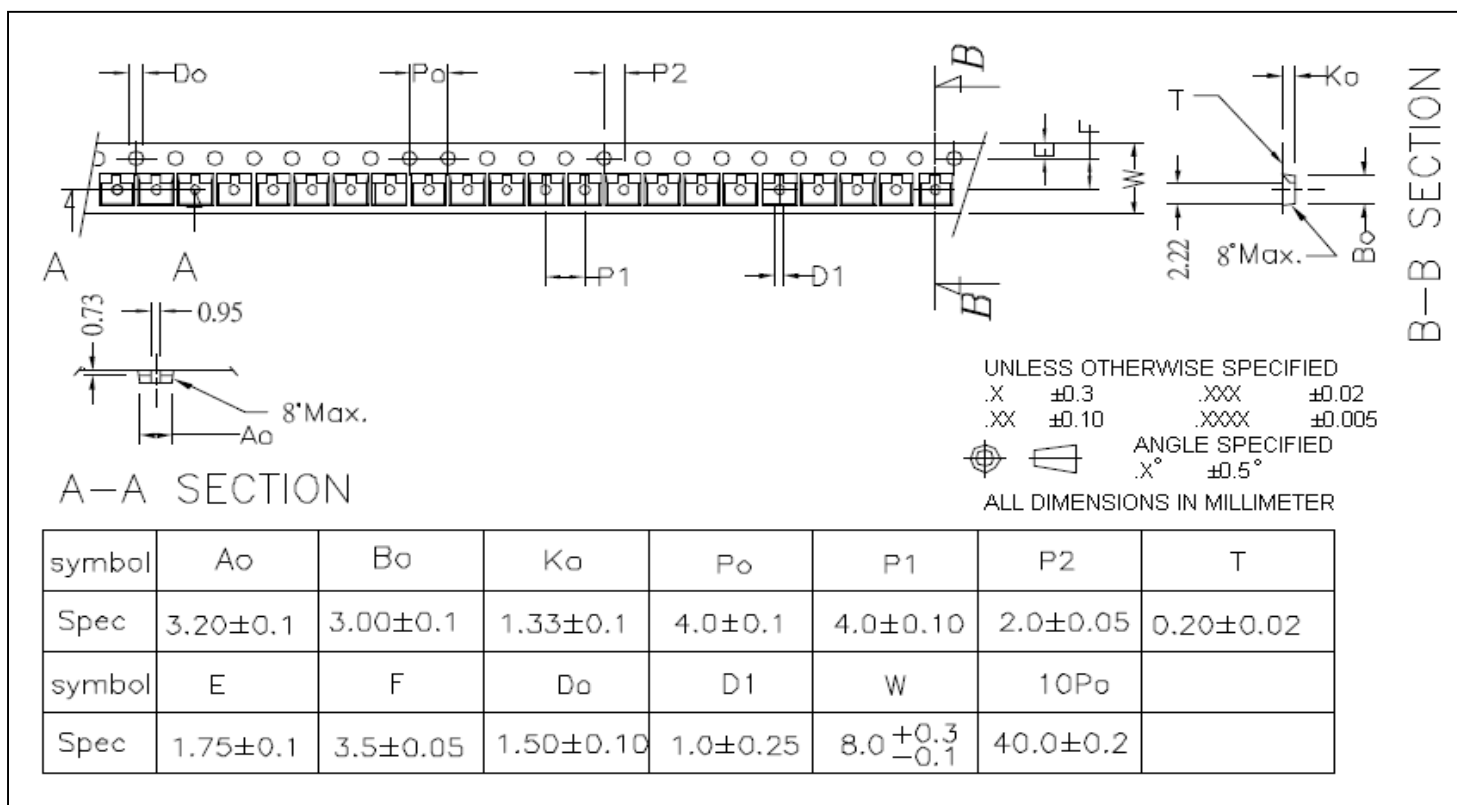

Recommended wave soldering condition

Product	Peak Temperature	Soldering Time
Pb-free devices	260 +0/-5 °C	5 +1/-1 seconds

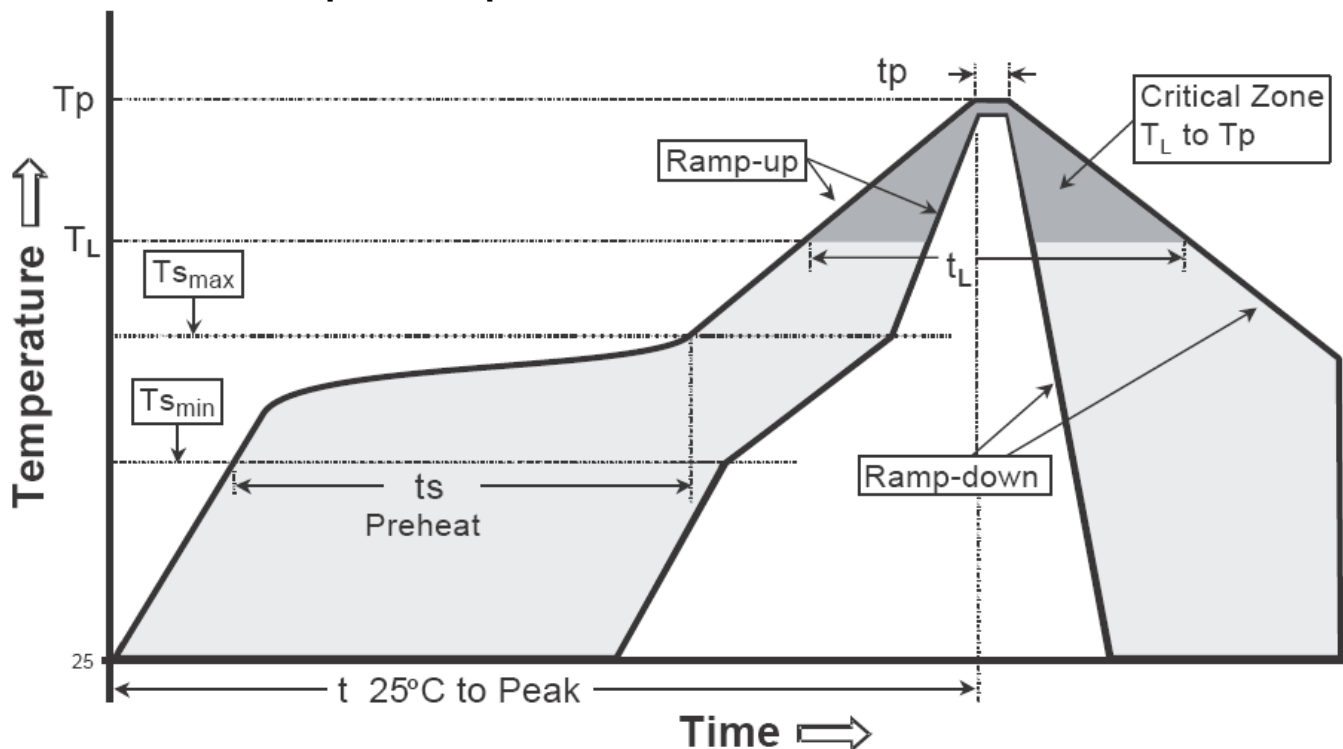
Recommended temperature profile for IR reflow

Profile feature	Sn-Pb eutectic Assembly	Pb-free Assembly
Average ramp-up rate (Ts_max to T _P)	3°C/second max.	3°C/second max.
Preheat		
-Temperature Min(T _s min)	100°C	150°C
-Temperature Max(T _s max)	150°C	200°C
-Time(t _s min to t _s max)	60-120 seconds	60-180 seconds
Time maintained above:		
-Temperature (T _L)	183°C	217°C
- Time (t _L)	60-150 seconds	60-150 seconds
Peak Temperature(T _P)	240 +0/-5 °C	260 +0/-5 °C
Time within 5°C of actual peak temperature(tp)	10-30 seconds	20-40 seconds
Ramp down rate	6°C/second max.	6°C/second max.
Time 25 °C to peak temperature	6 minutes max.	8 minutes max.

Note : All temperatures refer to topside of the package, measured on the package body surface.

SOT-23 Dimension

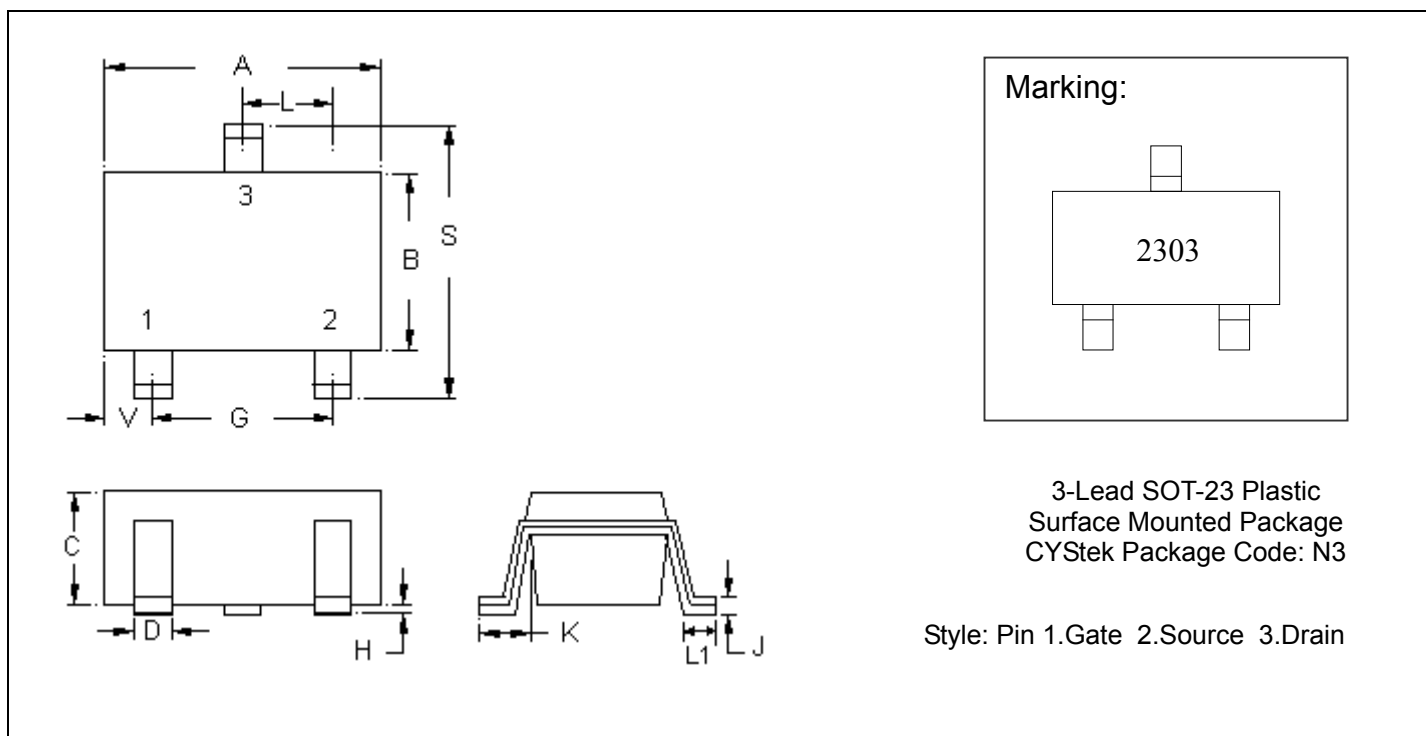

DIM	Inches		Millimeters		DIM	Inches		Millimeters	
	Min.	Max.	Min.	Max.		Min.	Max.	Min.	Max.
A	0.1102	0.1204	2.80	3.04	J	0.0032	0.0079	0.08	0.20
B	0.0472	0.0669	1.20	1.70	K	0.0118	0.0266	0.30	0.67
C	0.0335	0.0512	0.89	1.30	L	0.0335	0.0453	0.85	1.15
D	0.0118	0.0197	0.30	0.50	S	0.0830	0.1161	2.10	2.95
G	0.0669	0.0910	1.70	2.30	V	0.0098	0.0256	0.25	0.65
H	0.0000	0.0040	0.00	0.10	L1	0.0118	0.0197	0.30	0.50

Notes: 1.Controlling dimension: millimeters.
 2.Maximum lead thickness includes lead finish thickness, and minimum lead thickness is the minimum thickness of base material.
 3.If there is any question with packing specification or packing method, please contact your local CYStek sales office.

Material:

- Lead: Pure tin plated.
- Mold Compound: Epoxy resin family, flammability solid burning class: UL94V-0.

Important Notice:

- All rights are reserved. Reproduction in whole or in part is prohibited without the prior written approval of CYStek.
- CYStek reserves the right to make changes to its products without notice.
- CYStek **semiconductor products are not warranted to be suitable for use in Life-Support Applications, or systems.**
- CYStek assumes no liability for any consequence of customer product design, infringement of patents, or application assistance.