

ESD protected N-Channel Enhancement Mode MOSFET

MTNK5C3

BV _{DSS}	30V
I _D	100mA
R _{DS(on)MAX}	8Ω

Description

- Low voltage drive(2.5V drive) makes this device ideal for portable equipment.
- High speed switching
- ESD protected device
- Pb-free lead plating & halogen-free package

Symbol

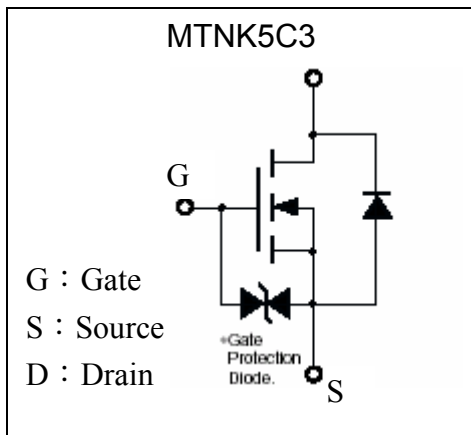

Outline

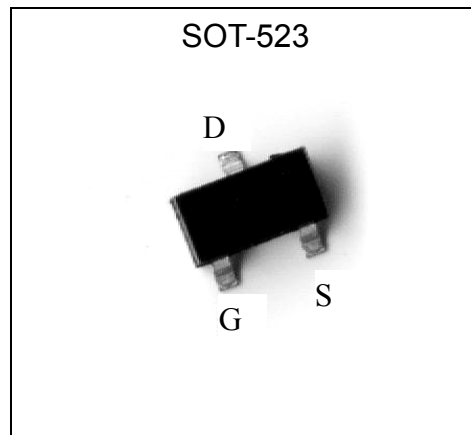

Absolute Maximum Ratings (Ta=25°C)

Parameter		Symbol	Limits	Unit
Drain-Source Voltage		BV _{DSS}	30	V
Gate-Source Voltage		V _{GS}	±20	V
Drain Current	Continuous	I _D	±100	mA
	Pulsed	I _{DP}	±200 *1	mA
Reverse Drain Current	Continuous	I _{DR}	±100	mA
	Pulsed	I _{DRP}	±200 *1	mA
Total Power Dissipation		P _D	150 *2	mW
ESD susceptibility			750 *3	V
Operating Junction and Storage Temperature Range		T _j ; T _{stg}	-55~+150	°C
Thermal Resistance, Junction-to-Ambient		R _{th,ja}	833	°C/W

Note : *1. Pulse Width ≤ 10μs, Duty cycle ≤ 1%
 *2. With each pin mounted on the recommended lands.
 *3. Human body model, 1.5kΩ in series with 100pF



Electrical Characteristics (Ta=25°C)

Symbol	Min.	Typ.	Max.	Unit	Test Conditions
Static					
BV _{DSS}	30	-	-	V	V _{GS} =0, I _D =100μA
V _{GS(th)}	0.8	1.3	1.5	V	V _{DS} =3V, I _D =100μA
I _{GSS}	-	-	±1	μA	V _{GS} =±20V, V _{DS} =0
I _{DSS}	-	-	100	nA	V _{DS} =30V, V _{GS} =0
R _{DSON}	-	3.4	8	Ω	V _{GS} =4V, I _D =10mA
	-	6.9	13		V _{GS} =2.5V, I _D =1mA
GFS	20	50	-	mS	V _{DS} =3V, I _D =10mA
Dynamic					
C _{iss}	-	12.5	-	pF	V _{DS} =5V, V _{GS} =0, f=1MHz
C _{oss}	-	7.3	-		
C _{rss}	-	3.5	-		
t _{d(on)}	-	15	-	ns	V _{DD} ≐ 5V, I _D =10mA, V _{GS} =5V, R _L =500Ω, R _G =10Ω
t _r	-	35	-		
t _{d(off)}	-	75	-		
t _f	-	75	-		
Source-Drain Diode					
*V _{SD}	-	0.88	1.2	V	V _{GS} =0V, I _S =100mA

*Pulse Test : Pulse Width ≤300μs, Duty Cycle ≤2%

Ordering Information

Device	Package	Shipping	Marking
MTNK5C3	SOT-523 (Pb-free lead plating & halogen-free package)	3000 pcs / Tape & Reel	KN



Typical Characteristics

Typical Output Characteristics

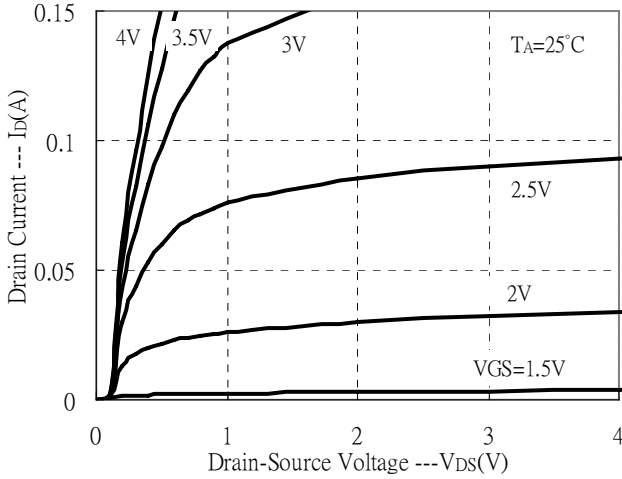

Gate Threshold Voltage vs Channel Temperature

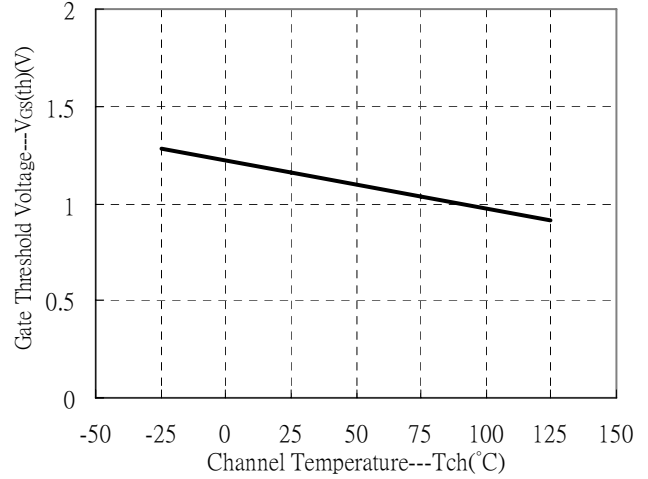

Typical Transfer Characteristics

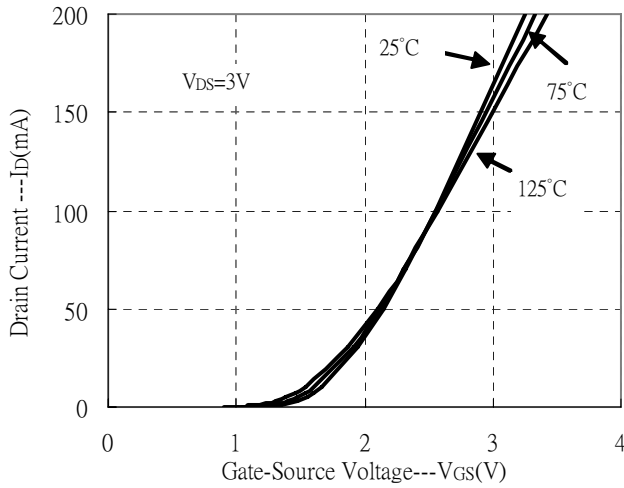

Static Drain-Source On-state Resistance with Temperature

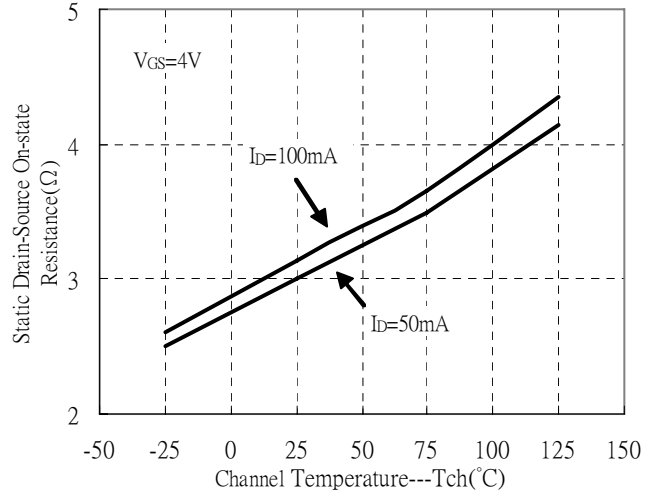

Static Drain-Source On-State resistance vs Drain Current

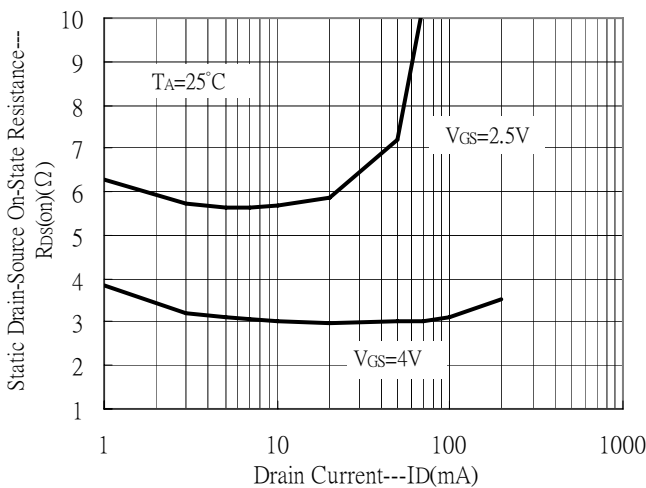

Static Drain-Source On-State resistance vs Drain Current

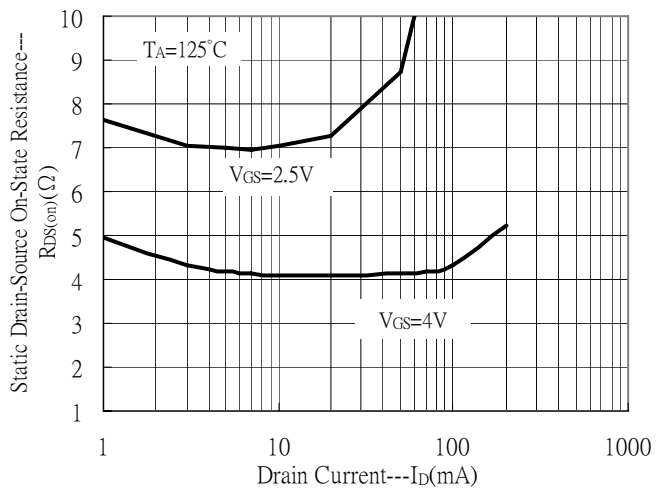

Typical Characteristics(Cont.)

Static Drain-Source On-State Resistance vs Drain Current

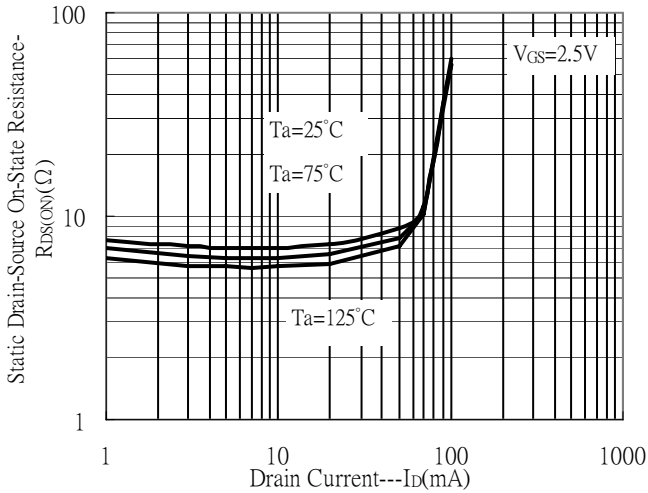

Static Drain-Source On-State Resistance vs Drain Current

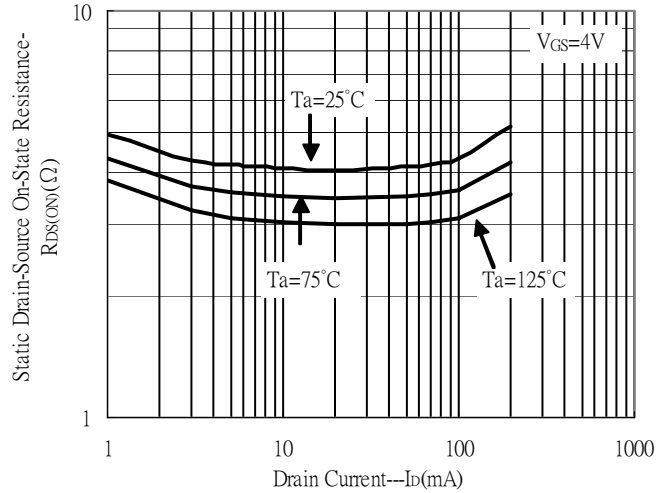

Static Drain-Source On-State Resistance vs Gate-Source Voltage

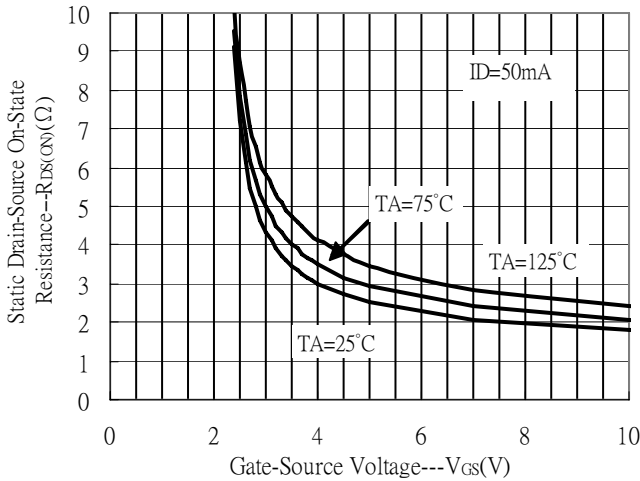

Static Drain-Source On-State Resistance vs Gate-Source Voltage

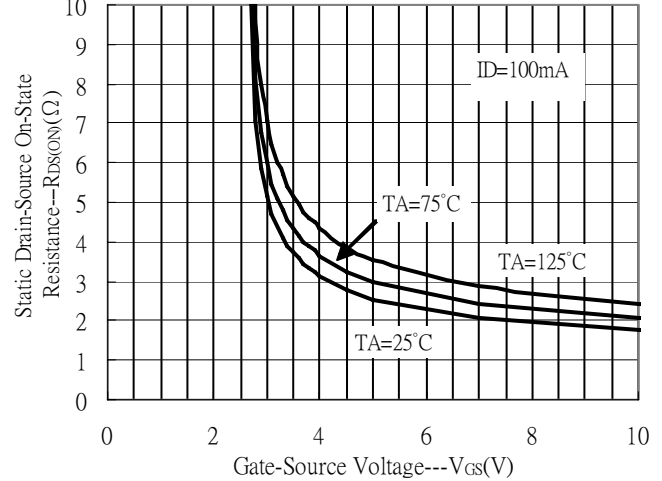

Reverse Drain Current vs Source-Drain Voltage(I)

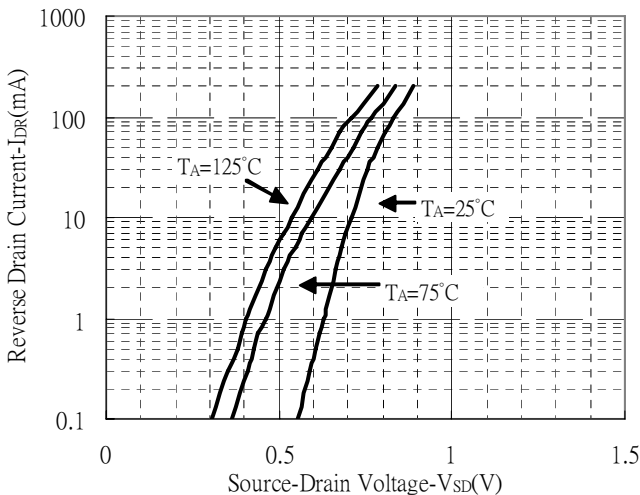

Reverse Drain Current vs Source-Drain Voltage(II)

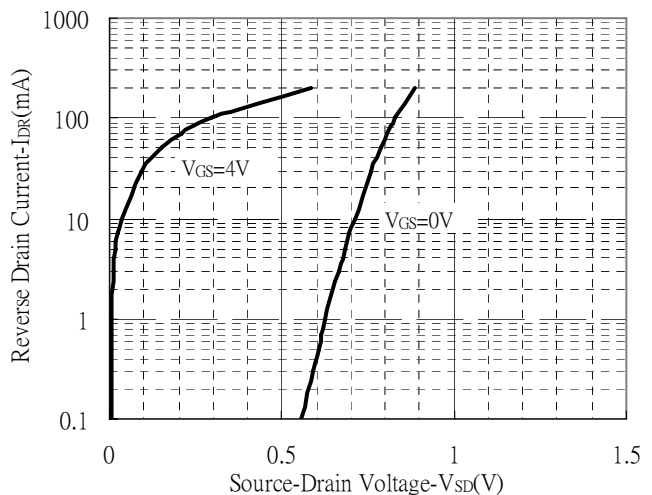



Typical Characteristics(Cont.)

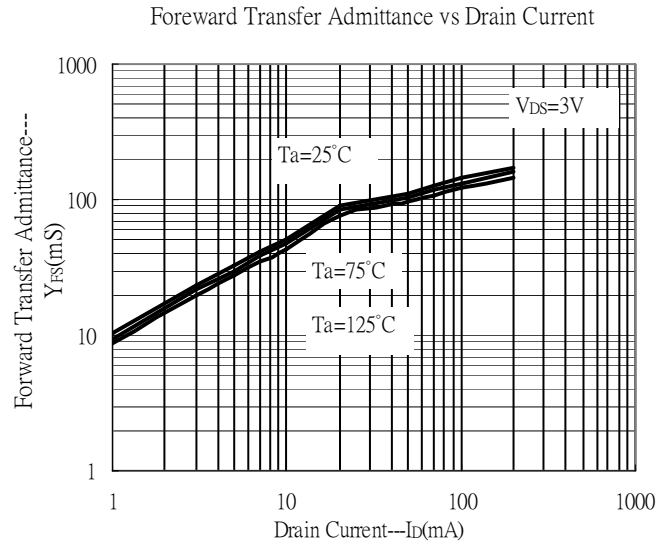
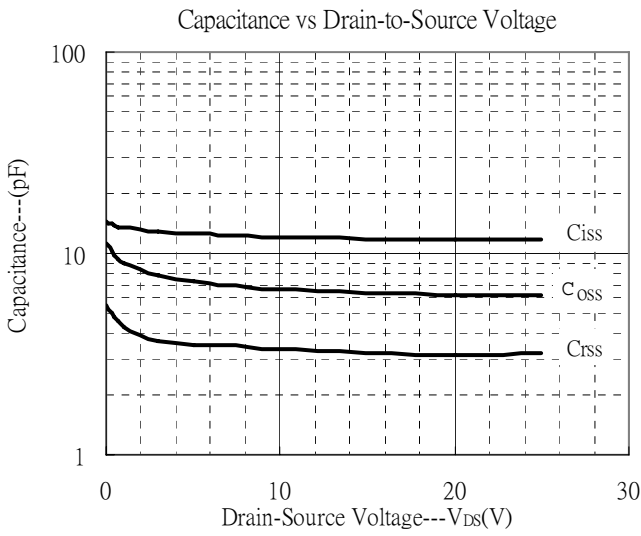

Recommended wave soldering condition

Product	Peak Temperature	Soldering Time
Pb-free devices	260 +0/-5 °C	5 +1/-1 seconds

Recommended temperature profile for IR reflow

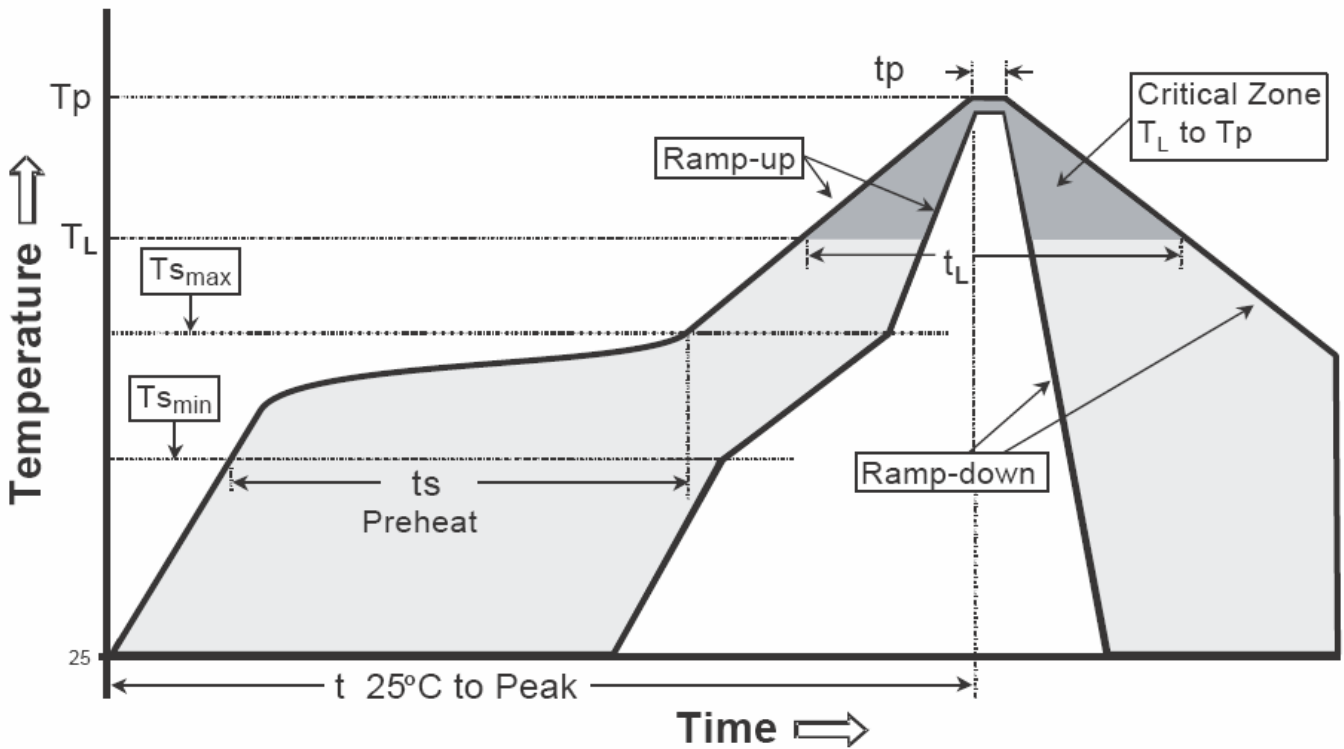

Profile feature	Sn-Pb eutectic Assembly	Pb-free Assembly
Average ramp-up rate (Tsmmax to Tp)	3°C/second max.	3°C/second max.
Preheat		
-Temperature Min(Ts min)	100°C	150°C
-Temperature Max(Ts max)	150°C	200°C
-Time(ts min to ts max)	60-120 seconds	60-180 seconds
Time maintained above:		
-Temperature (TL)	183°C	217°C
- Time (tL)	60-150 seconds	60-150 seconds
Peak Temperature(TP)	240 +0/-5 °C	260 +0/-5 °C
Time within 5°C of actual peak temperature(tp)	10-30 seconds	20-40 seconds
Ramp down rate	6°C/second max.	6°C/second max.
Time 25 °C to peak temperature	6 minutes max.	8 minutes max.

Note : All temperatures refer to topside of the package, measured on the package body surface.

SOT-523 Dimension

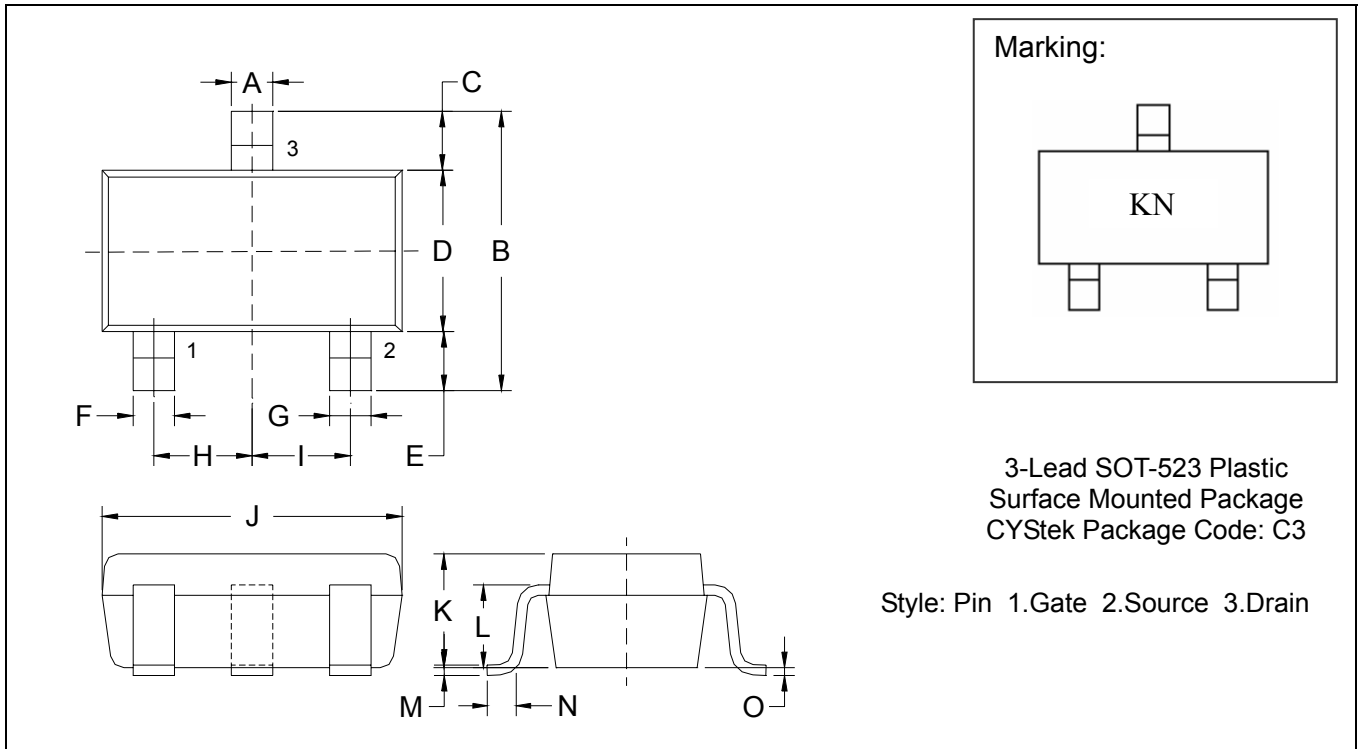

*: Typical

DIM	Inches		Millimeters		DIM	Inches		Millimeters	
	Min.	Max.	Min.	Max.		Min.	Max.	Min.	Max.
A	0.0079	0.0157	0.20	0.40	I	*0.0197	-	*0.50	-
B	0.0591	0.0669	1.50	1.70	J	0.0610	0.0650	1.55	1.65
C	0.0118	0.0197	0.30	0.50	K	0.0276	0.0315	0.70	0.80
D	0.0295	0.0335	0.75	0.85	L	0.0224	0.0248	0.57	0.63
E	0.0118	0.0197	0.30	0.50	M	0.0020	0.0059	0.05	0.15
F	0.0039	0.0118	0.10	0.30	N	0.0039	0.0118	0.10	0.30
G	0.0039	0.0118	0.10	0.30	O	0	0.0031	0	0.08
H	*0.0197	-	*0.50	-					

Notes: 1.Controlling dimension: millimeters.
 2.Maximum lead thickness includes lead finish thickness, and minimum lead thickness is the minimum thickness of base material.
 3.If there is any question with packing specification or packing method, please contact your local CYStek sales office.

Material:

- Lead: Pure tin plated.
- Mold Compound: Epoxy resin family, flammability solid burning class: UL94V-0

Important Notice:

- All rights are reserved. Reproduction in whole or in part is prohibited without the prior written approval of CYStek.
- CYStek reserves the right to make changes to its products without notice.
- CYStek **semiconductor products are not warranted to be suitable for use in Life-Support Applications, or systems.**
- CYStek assumes no liability for any consequence of customer product design, infringement of patents, or application assistance.