

N-Channel Enhancement Mode Power MOSFET

MTN2N65CJ3

BV_{DSS}	650V
I_D @ V_{GS}=10V, T_C=25°C	2A
I_D @ V_{GS}=10V, T_C=100°C	1.3A
R_{DS(ON)} @ V_{GS}=10V, I_D=1A	4.5Ω (typ)

Features

- Low On Resistance
- Simple Drive Requirement
- Low Gate Charge
- Fast Switching Characteristic
- Pb-free lead plating and halogen-free package

Applications

- Open Framed Power Supply
- Adapter
- STB

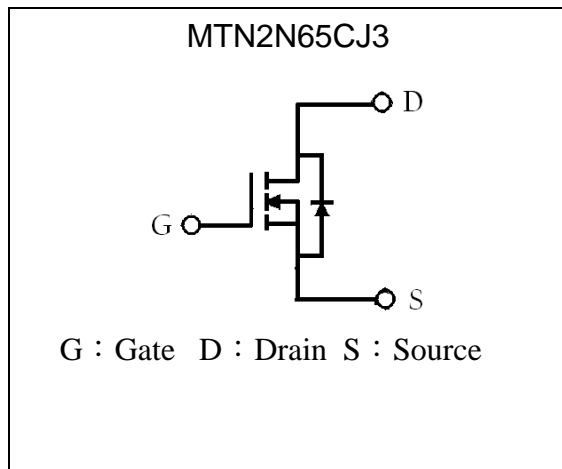
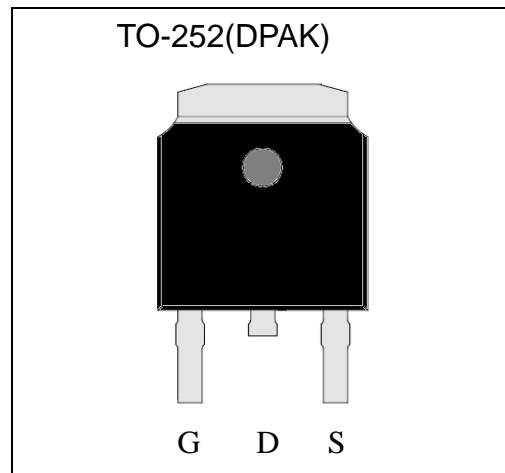
Symbol

Outline

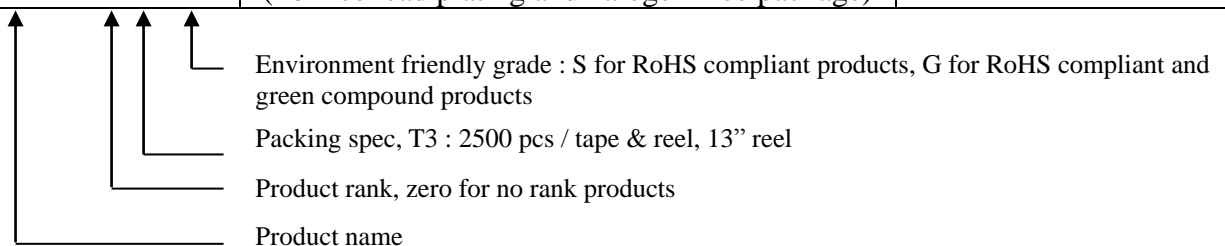
Ordering Information

Device	Package	Shipping
MTN2N65CJ3-0-T3-G	TO-252 (Pb-free lead plating and halogen-free package)	2500 pcs / Tape & Reel



**Absolute Maximum Ratings** ($T_C=25^{\circ}\text{C}$)

Parameter	Symbol	Limits	Unit
Drain-Source Voltage	V_{DS}	650	V
Gate-Source Voltage	V_{GS}	± 30	
Continuous Drain Current	I_D	2.0	A
Continuous Drain Current @ $T_C=100^{\circ}\text{C}$		1.3	
Pulsed Drain Current @ $V_{GS}=10\text{V}$ (Note 1)	I_{DM}	8.0	
Single Pulse Avalanche Current (Note 2)	I_{AS}	2	
Single Pulse Avalanche Energy @ $L=2\text{mH}$, $V_{GS}=10\text{V}$, $V_{DD}=50\text{V}$ (Note 2)	E_{AS}	4	mJ
Repetitive Avalanche Energy (Note 1)	E_{AR}	4.4	
Maximum Temperature for Soldering @ Lead at 0.125 in(0.318mm) from case for 10 seconds	T_L	300	$^{\circ}\text{C}$
Total Power Dissipation ($T_A=25^{\circ}\text{C}$)	P_D	1.14	W
Total Power Dissipation ($T_C=25^{\circ}\text{C}$)		44	W
Linear Derating Factor		0.35	W/ $^{\circ}\text{C}$
Operating Junction and Storage Temperature	T_j, T_{stg}	-55~+150	$^{\circ}\text{C}$

Note : 1.Pulse width limited by maximum junction temperature.

2.100% tested by conditions of $I_{AS}=1\text{A}$, $V_{DD}=50\text{V}$, $L=1\text{mH}$, $V_{GS}=10\text{V}$, starting $T_J=+25^{\circ}\text{C}$.

Thermal Data

Parameter	Symbol	Value	Unit
Thermal Resistance, Junction-to-case, max	$R_{\theta JC}$	2.8	$^{\circ}\text{C}/\text{W}$
Thermal Resistance, Junction-to-ambient, max	$R_{\theta JA}$	110	

Characteristics (T_c=25°C, unless otherwise specified)

Symbol	Min.	Typ.	Max.	Unit	Test Conditions
Static					
BV _{DSS}	650	-	-	V	V _{GS} =0V, I _D =250μA, T _j =25°C
ΔBV _{DSS} /ΔT _j	-	0.7	-	V/°C	Reference to 25°C, I _D =250μA
V _{GS(th)}	2.0	-	4.0	V	V _{DS} = V _{GS} , I _D =250μA
*G _{FS}	-	2.3	-	S	V _{DS} = 15V, I _D =1A
I _{GSS}	-	-	±100	nA	V _{GS} =±30V, V _{DS} =0V
I _{DSS}	-	-	1	μA	V _{DS} = 650V, V _{GS} = 0V
	-	-	10		V _{DS} = 520V, V _{GS} = 0V, T _C =125°C
*R _{DS(ON)}	-	4.5	5.8	Ω	V _{GS} = 10V, I _D =1A
Dynamic					
*Q _g	-	7.8	11.7	nC	I _D =2A, V _{DD} =520V, V _{GS} =10V
*Q _{gs}	-	2.3	-		
*Q _{gd}	-	2.4	-		
*t _{d(ON)}	-	5.4	10.8	ns	V _{DD} =325V, I _D =1.8A, V _{GS} =10V, R _G =25Ω
*t _r	-	3.2	6.4		
*t _{d(OFF)}	-	8.6	17.2		
*t _f	-	5.6	11.2		
C _{iss}	-	268	402	pF	V _{GS} =0V, V _{DS} =25V, f=1MHz
C _{oss}	-	32	48		
C _{rss}	-	11	16		
R _g	-	3.7	-	Ω	f=1MHz
Source-Drain Diode					
*I _S	-	-	2	A	
*I _{SM}	-	-	8		
*V _{SD}	-	0.8	1.5	V	I _S =1A, V _{GS} =0V
*t _{rr}	-	286	-	ns	V _{GS} =0V, I _F =1.8A, dI _F /dt=100A/μs
*Q _{rr}	-	760	-	nC	

*Pulse Test : Pulse Width ≤300μs, Duty Cycle≤2%

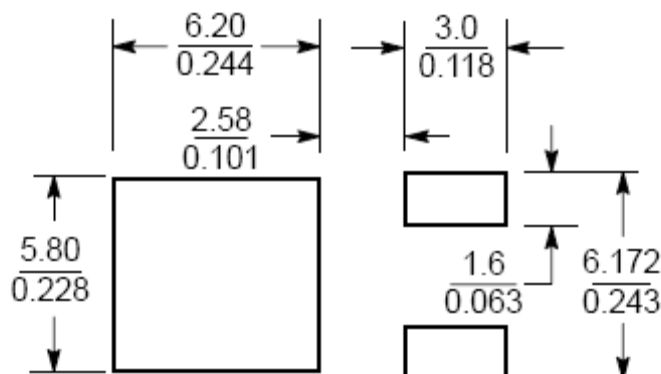
Recommended soldering footprint

 Unit ($\frac{\text{mm}}{\text{inch}}$)

Typical Characteristics

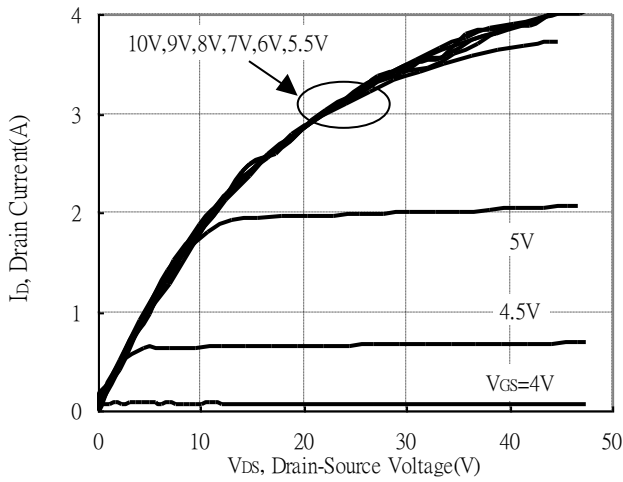
Typical Output Characteristics

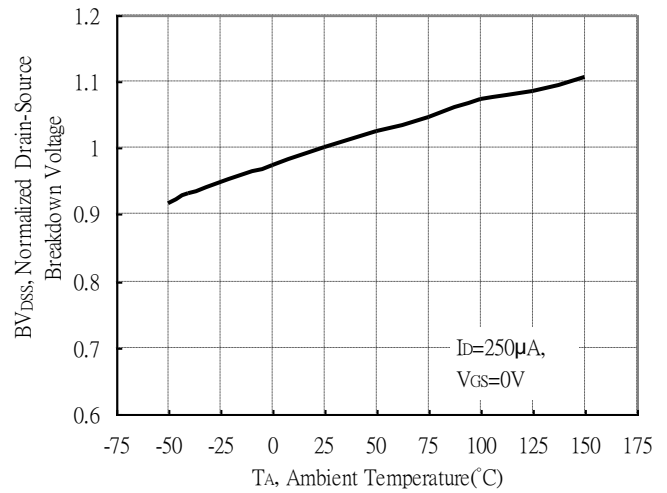

Brekdown Voltage vs Ambient Temperature



Static Drain-Source On-State resistance vs Drain Current

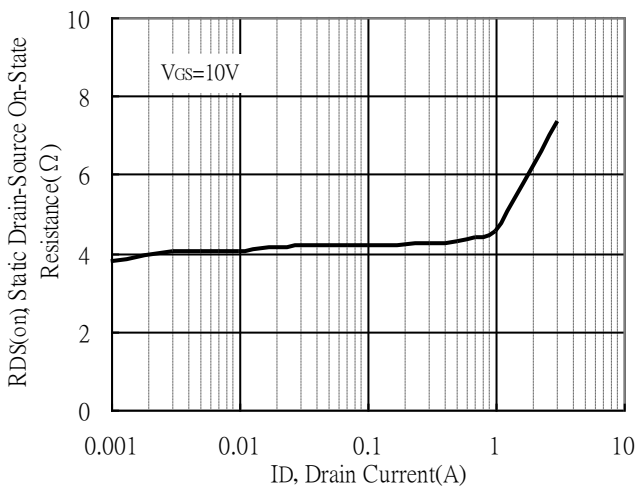

Drain Current vs Gate-Source Voltage

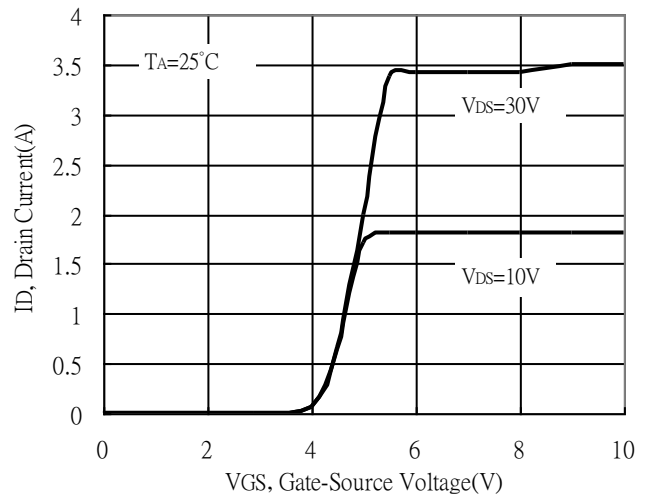

Static Drain-Source On-State Resistance vs Gate-Source Voltage

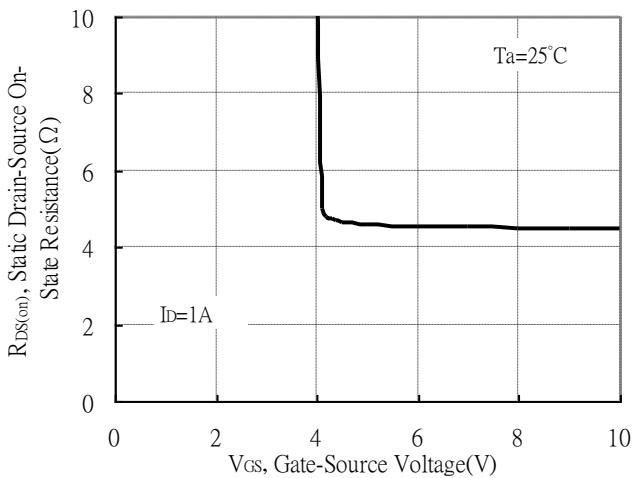

Forward Drain Current vs Source-Drain Voltage

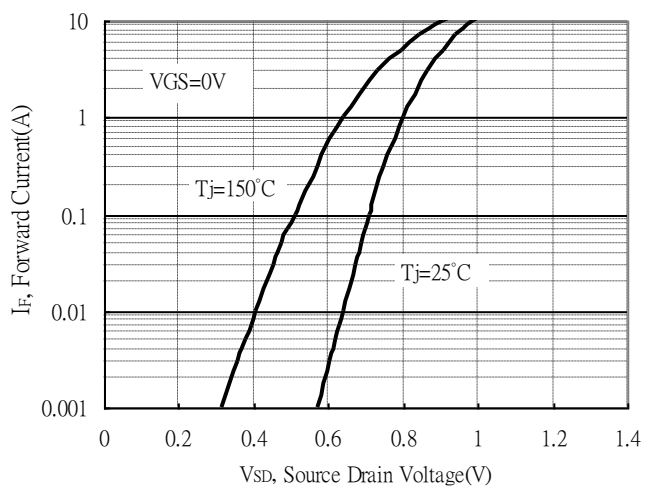

Typical Characteristics(Cont.)

Capacitance vs Reverse Voltage

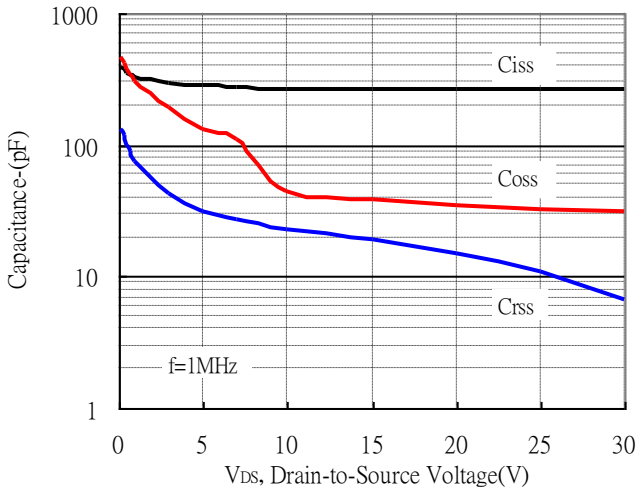

Static Drain-Source On-resistance vs Ambient Temperature

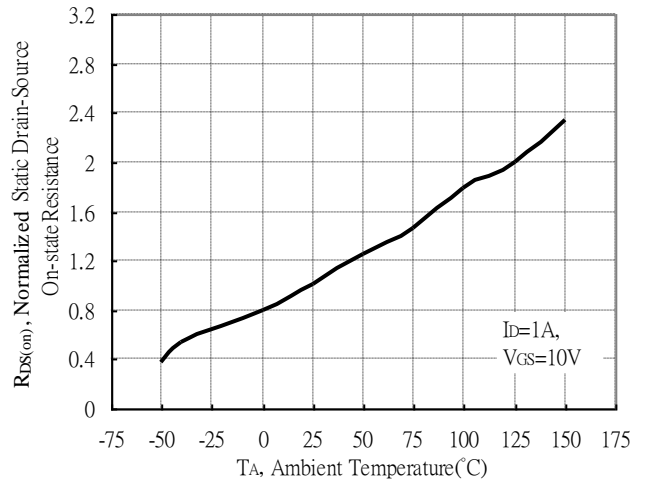

Maximum Safe Operating Area

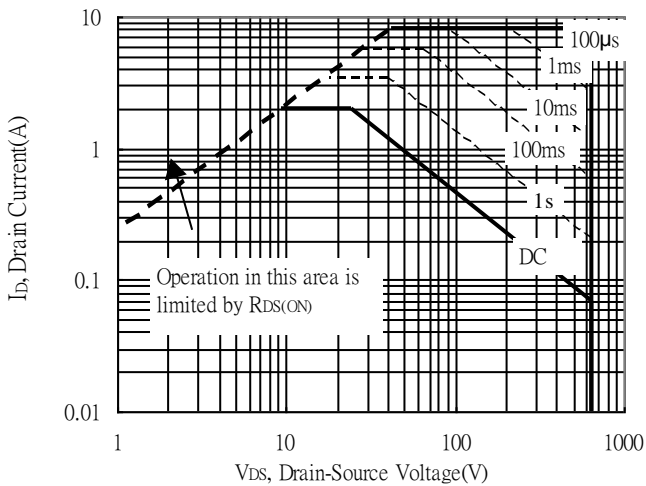

Gate Charge Characteristics

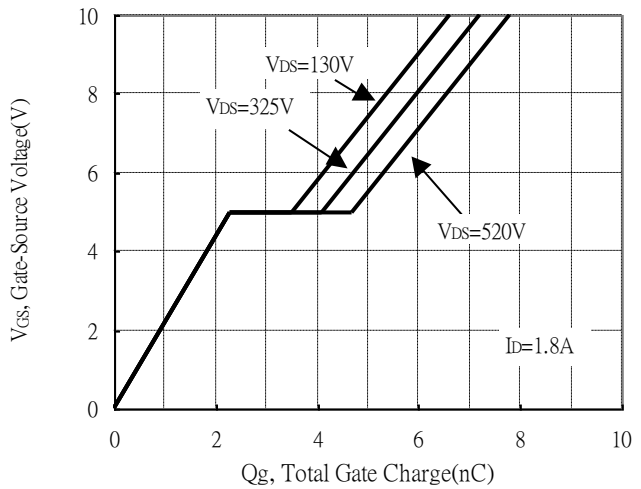

Maximum Drain Current vs Case Temperature

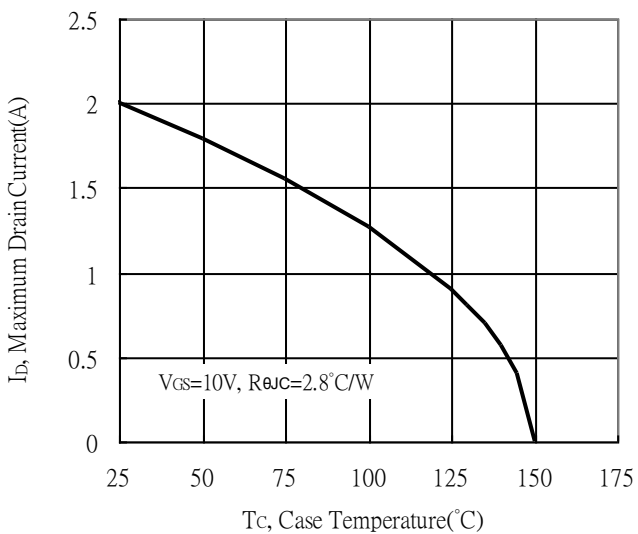

Threshold Voltage vs Junction Temperature

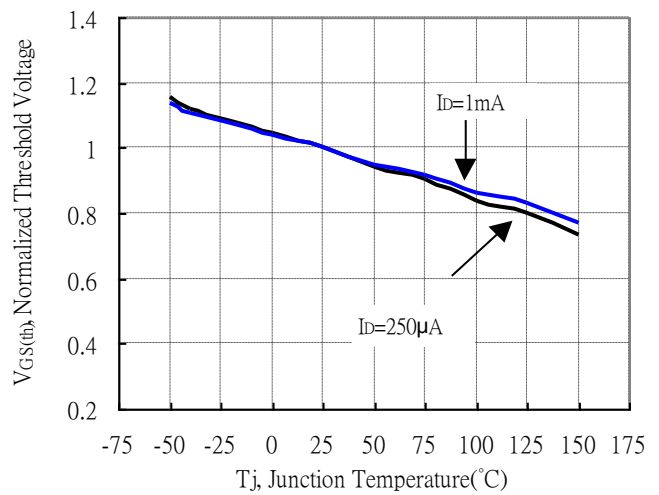

Typical Characteristics(Cont.)

Single Pulse Power Rating, Junction to Case

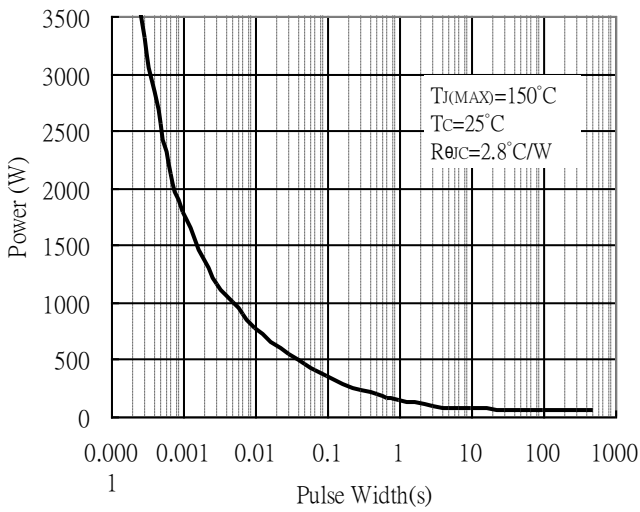

Forward Transfer Admittance vs Drain Current

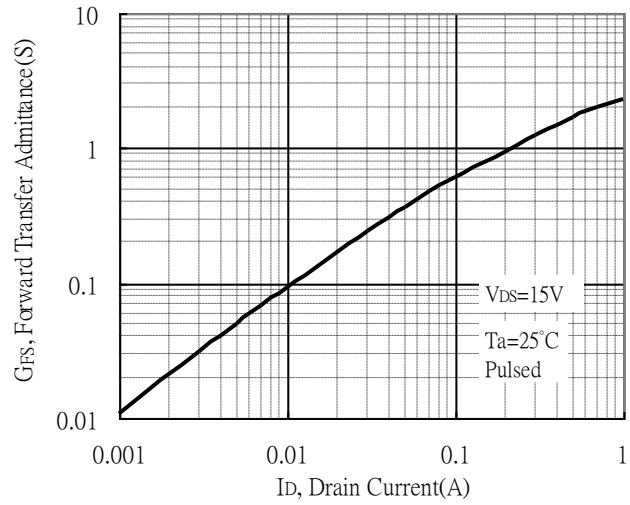

Transient Thermal Response Curves

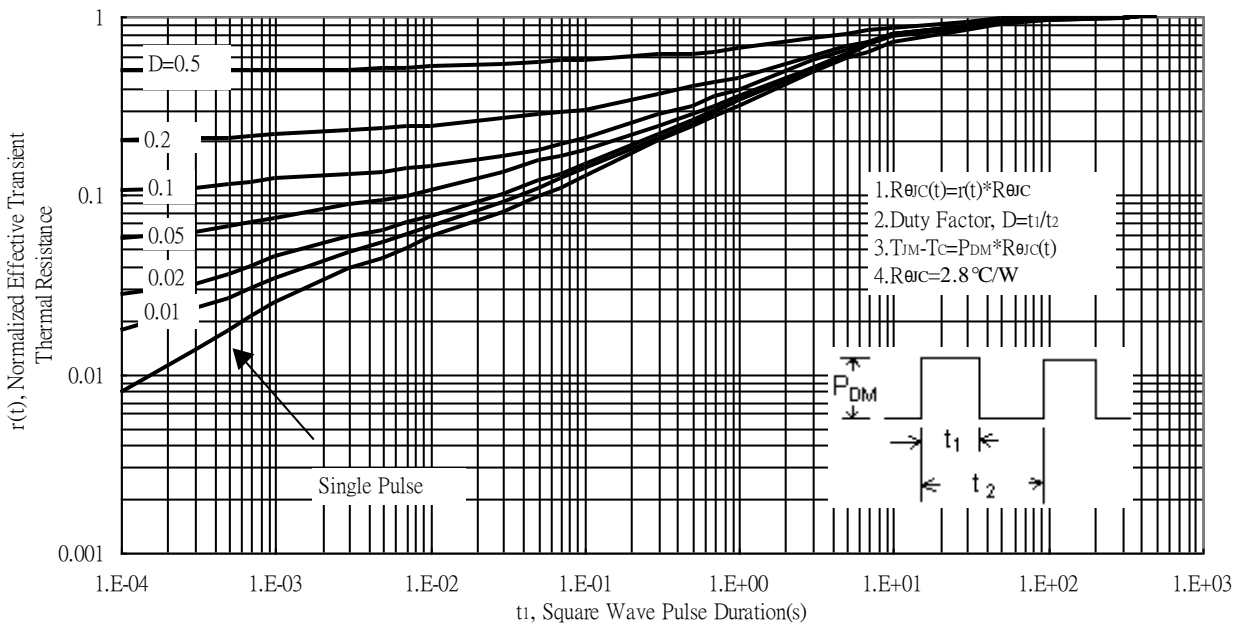

Reel Dimension

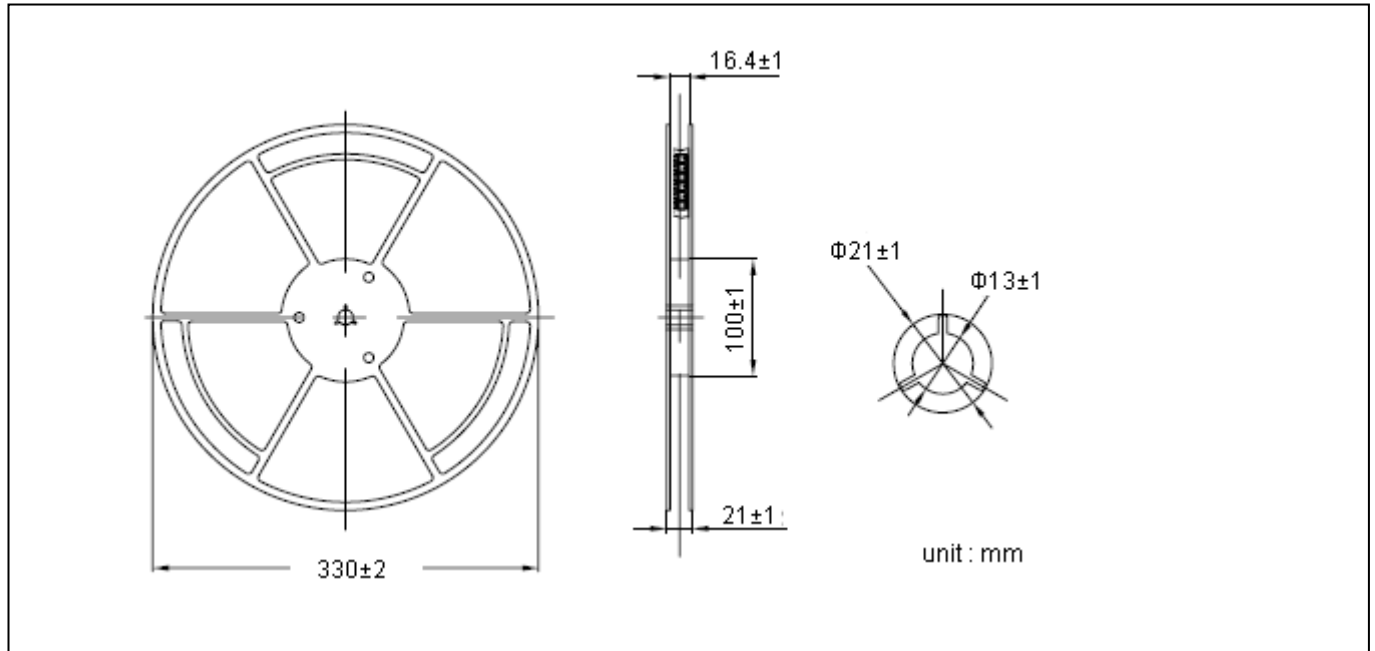

Carrier Tape Dimension

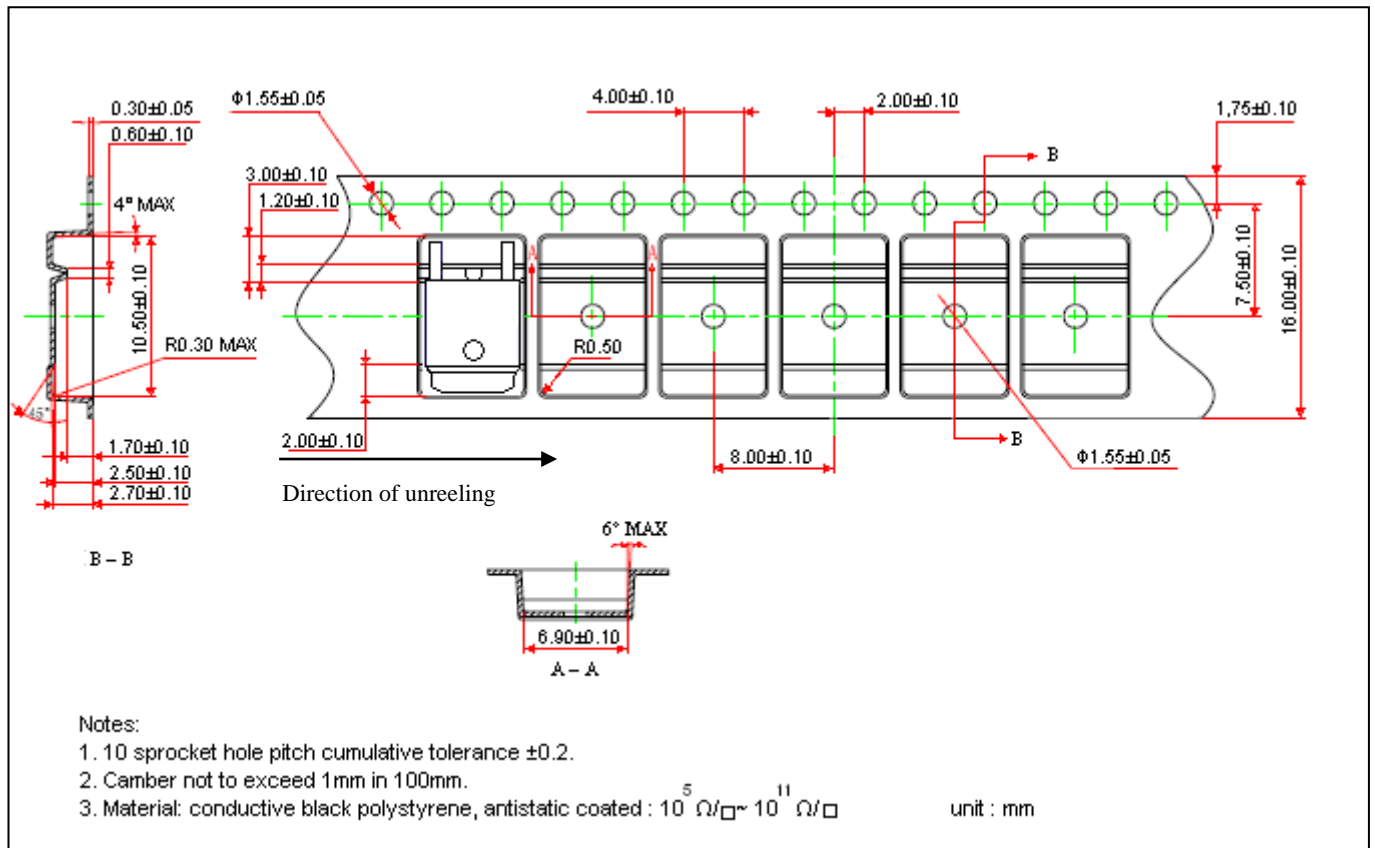

Recommended wave soldering condition

Product	Peak Temperature	Soldering Time
Pb-free devices	260 +0/-5 °C	5 +1/-1 seconds

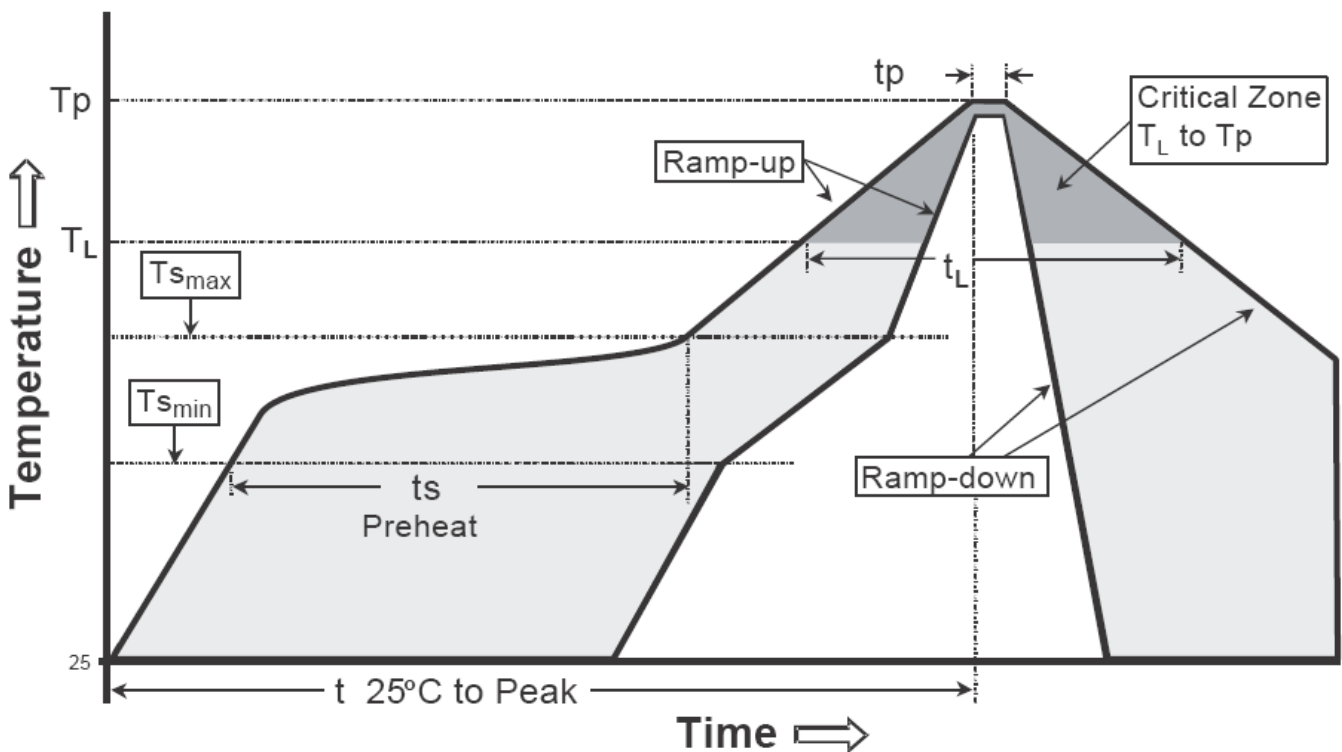
Recommended temperature profile for IR reflow

Profile feature	Sn-Pb eutectic Assembly	Pb-free Assembly
Average ramp-up rate (Tsmax to Tp)	3°C/second max.	3°C/second max.
Preheat		
-Temperature Min(Ts min)	100°C	150°C
-Temperature Max(Ts max)	150°C	200°C
-Time(ts min to ts max)	60-120 seconds	60-180 seconds
Time maintained above:		
-Temperature (Tl)	183°C	217°C
- Time (tl)	60-150 seconds	60-150 seconds
Peak Temperature(TP)	240 +0/-5 °C	260 +0/-5 °C
Time within 5°C of actual peak temperature(tp)	10-30 seconds	20-40 seconds
Ramp down rate	6°C/second max.	6°C/second max.
Time 25 °C to peak temperature	6 minutes max.	8 minutes max.

Note : All temperatures refer to topside of the package, measured on the package body surface.

TO-252 Dimension

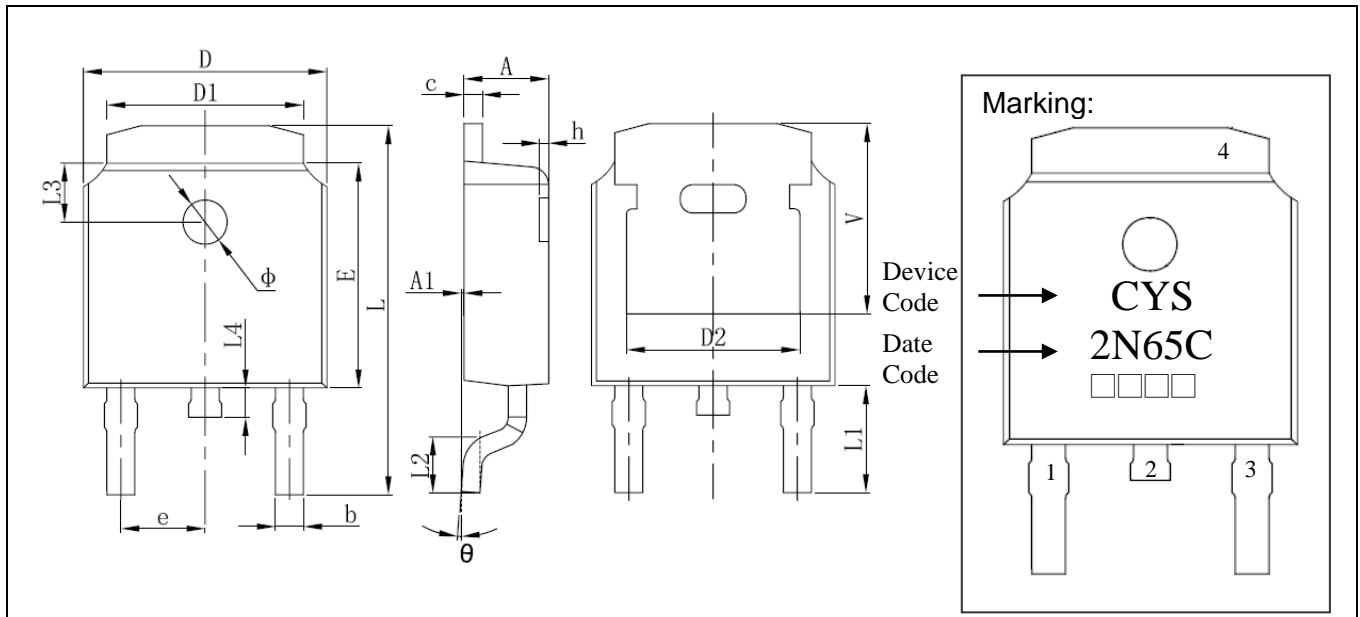

3-Lead TO-252 Plastic Surface Mount Package
 Date Code : CYStek Package Code : J3
 First Code : Last digit of Christian Year
 Second Code : Month Code : Jan→A, Feb→B, Mar→C, Apr→D, May→E, Jun→F, Jul→G,
 Aug→H, Sep→J, Oct→K, Nov→L, Dec→M
 Last Two Codes : Production Serial Code, 01~99

Style: Pin 1.Gate 2.Drain 3.Source 4.Drain

DIM	Inches		Millimeters		DIM	Inches		Millimeters	
	Min.	Max.	Min.	Max.		Min.	Max.	Min.	Max.
A	0.087	0.094	2.200	2.400	L	0.382	0.406	9.712	10.312
A1	0.000	0.005	0.000	0.127	L1	0.114	REF	2.900	REF
b	0.025	0.030	0.635	0.770	L2	0.055	0.067	1.400	1.700
c	0.018	0.023	0.460	0.580	L3	0.063	REF	1.600	REF
D	0.256	0.264	6.500	6.700	L4	0.024	0.039	0.600	1.000
D1	0.201	0.215	5.100	5.460	Φ	0.043	0.051	1.100	1.300
D2	0.190	REF	4.830	REF	θ	0°	8°	0°	8°
E	0.236	0.244	6.000	6.200	h	0.000	0.012	0.000	0.300
e	0.086	0.094	2.186	2.386	v	0.207	REF	5.250	REF

Notes: 1.Controlling dimension: millimeters.
 2.Maximum lead thickness includes lead finish thickness, and minimum lead thickness is the minimum thickness of base material.
 3.If there is any question with packing specification or packing method, please contact your local CYStek sales office.

Material:

- Lead : Pure tin plated.
- Mold Compound: Epoxy resin family, flammability solid burning class: UL94V-0.

Important Notice:

- All rights are reserved. Reproduction in whole or in part is prohibited without the prior written approval of CYStek.
- CYStek reserves the right to make changes to its products without notice.
- CYStek **semiconductor products are not warranted to be suitable for use in Life-Support Applications, or systems.**
- CYStek assumes no liability for any consequence of customer product design, infringement of patents, or application assistance.